

D-Link[®]

DVG-6008G User Manual v1.1

Table of Contents

1. Product Description	4
1.1 Overview	4
1.2 Scenario of Application	4
1.3 Product Appearance	4
1.4 Functions and Features	7
1.4.1 Protocols	7
1.4.2 System Function	7
1.4.3 Industrial Standards Supported	7
1.4.4 General Hardware Specification	8
2. Installation Guide	9
2.1 Installation Notice	9
2.2 Installation Procedure	9
2.2.1 Install SIM Card	9
2.2.2 Antenna Installation	9
2.2.3 Network Cable Connection of Equipment	10
3. Basic Operation	11
3.1 IVR Navigator	11
3.2 Basic Operation	11
4. WEB Interface Configuration	12
4.1 Access DVG-6008G unit	12
4.2 Parameters Configuration	13
4.3 System Information	13
4.3.1 System Information	13
4.3.2 Mobile Information	14
4.3.3 SIP Information	16
4.4 Statistics	16
4.4.1 TCP/UDP	16
4.4.2 RTP	16
4.4.3 SIP Call History	17
4.4.4 IP to GSM Call History	18
4.4.5 CDR Report	18
4.4.6 Auto Lock BCCH History	19
4.5 Network Configuration	20
4.5.1 Local Network	20
4.5.2 ARP	21
4.5.3 VPN Parameter	21
4.6 Mobile Configuration	22
4.6.1 Basic Configuration	22
Example:	24
Configuration between SMS box and gateway	24

Configure API parameters on gateway	24
Configure SMS box	24
how to configure abnormal call on gateway	25
Low ASR Less Than 20%.....	26
Low ACD Less Than 300s.....	25
Counts of Call Failed.....	25
Mobile Operate	25
4.6.2 Mobile Configuration.....	25
How to configure maximum call limitation.....	28
4.6.3 PIN Management.....	29
4.6.5 SMSC.....	29
4.6.6 Send SMS/Recv SMS.....	30
4.6.7 USSD.....	30
4.6.8 Carrier	31
4.6.9 BCCH	32
4.6.10 Call Forwarding.....	33
4.6.11 Call Waiting.....	33
4.6.12 SIM Mode	33
4.6.13 Cloud Server	34
4.7 Routing Configuration	35
4.7.1 Routing Parameter	35
4.7.2 IP->Tel Routing	36
4.7.3 Tel->IP Routing	37
4.8 Manipulaton Configuration	39
4.8.1 IP->Tel Destination Numbers.....	39
4.8.2 Tel->IP Source Numbers	41
4.8.3 Tel->IP Destination Numbers.....	43
4.9 Operation	45
4.9.1 IP->Tel Operation.....	45
4.9.2 Tel->IP Operation.....	47
4.10 Port Group Configuration	49
4.10.1 Port Group.....	49
4.11 IP Trunk Configuration	49
4.11.1 IP Trunk.....	49
4.11.2 IP Trunk Group.....	50
4.12 System Configuration.....	51
4.12.1 Service Parameter	51
4.12.2 SIP Parameter	55
4.12.3 Port Parameter	61
4.13 Digit Map.....	63
4.14 Tools	64
4.14.1 Firmware Upload	64
4.14.2 Syslog	65

4.14.3 Filelog /Filelog Download	66
4.14.4 Management Parameter	66
4.14.5 Config Backup	67
4.14.6 Config Restore.....	67
4.14.7 IVR Voice Prompt Upload	68
4.14.8 Ping Test.....	68
4.14.9 Tracert Test.....	69
4.14.10 Network Capture	69
4.14.11 Voice Loopback Test.....	73
4.14.13 Username & Password	74
4.14.14 Factory Reset	75
4.14.15 Restart	75
5. Troubleshooting and Command Line.....	76
5.1 Login DWG & General Knowledge of DWG Command.....	76
5.2. Commands in "ROS#" Mode	76
5.2.1 Summarize of commands in "ROS#" mode	77
5.2.2 General Purpose Commands in "ROS#" mode.....	77
Show IP address (show int)	77
Show Time (show clock).....	77
Show version (show version).....	77
Show sip Information (show sip config)	78
Show memory status (show memory detail)	79
Show SIP port status (show sip all)	79
Show Current calls (sh ecc call).....	79
Show RTP session (sho rtp se).....	80
Show ASR/ACD statistics (show ecc state).....	80
5.3 Commands in "Config" Mode.....	80
5.3.1 Summarize of commands in "config" mode.....	80
5.3.2 General Purpose Commands in "Config" mode	81
Set time (clock set).....	81
Save the configuration (save).....	82
Restart device (reset eia).....	82
Enable debug	82
Enable SIP debug (deb sip msg all)	82
5.4 How to trace SIP logs.....	82
5.5 How to trace ECC logs (Call Details).....	83
5.6 How to trace Module logs	83
6. The Way to Increase Antenna Isolation.....	85
7. Frequency Asked Questions	88
8. Glossary	90

1. Product Description

This chapter mainly introduces functions and structures of DVG-6008G/F/G.

1.1 Overview

DVG-6008G serials GSM/CDMA VoIP Gateway is full functions VoIP gateway based on IP and Mobile network, which provides a flexible network configuration, powerful features, and good voice quality. It works for carrier grade, enterprise, SOHO, residential users for cost-effective solution.

1.2 Scenario of Application

With the development of users and telecom service, mobile network and fixed network integration will be steadily increasing. DVG-6008G provides high quality VoIP service which perfectly meets the requirement. This is a scenario shown as figure 1-2-1

Figure 1-2-1 Network scenario

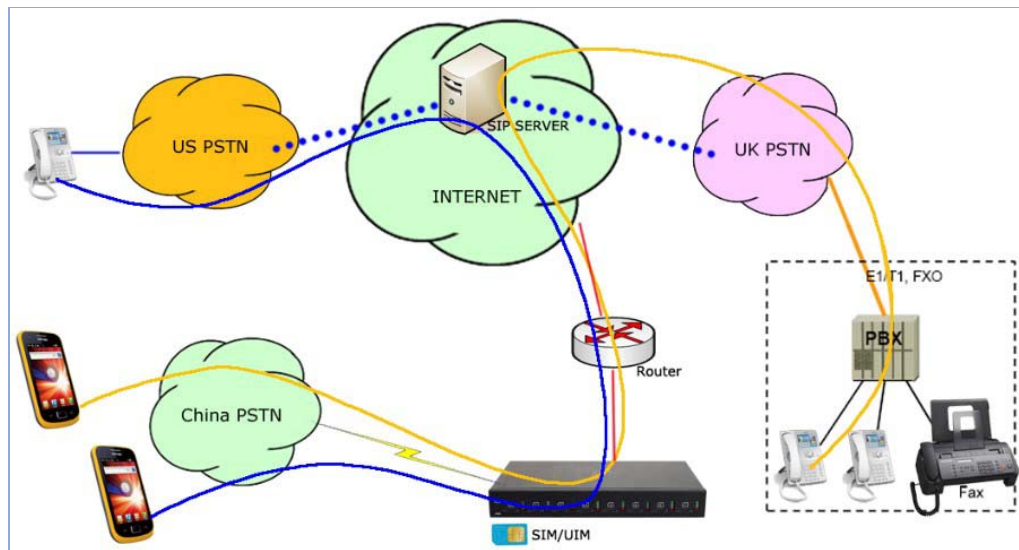

1.3 Product Appearance

The appearance of DVG-6008G shows as follow

Figure 1-3-1 Front view of DVG-6008G



Table 1-3-1 Description of Front view





Index	Indicators	Description
1	RUN	On: Starting Off: Abnormal Blinking every 0.5s: Normalstatus
2	PWR	On: Power on Off: Power off
3	Signal	 Signal strength indicators with green color
4	Channel	 Use/Unuse indicator with Red color, ON is used, Off is unused
5	SIM Slots	 SIM card slot

Figure 1-3-2 Rear view of DVG-6008G



Table 1-3-2 Description of Rear view

Index	Interface	Description
1	Power Connector	 Power connector of DC power. Input: DC12V
2	Antenna Connector	Mark as digits 0 to 7
3	Network	FE0 and FE1, its default IP address 192.168.11.1
4	Console	RS232 standard, band rate 115200bps
5	RST	Reset button to restore default IP and password or restore factory setting. <ul style="list-style-type: none"> Restore IP and Password: hold RST button 3~5 seconds, RUN LED being ON during this time Restore factory setting: Hold RST button 7 seconds, RUN LED being blink

1.4 Functions and Features

1.4.1 Protocols

- Standard SIP;
- Simple Traversal of UDP over NATs (STUN);
- Point-to-point protocol over Ethernet (PPPoE);
- Hypertext Transfer Protocol (HTTP);
- Dynamic Host Configuration Protocol (DHCP);
- Domain Name System (DNS);
- ITU-T G.711 α -Law/ μ -Law、G.723.1、G.729AB;
- PPTP available on DVG-6008G

1.4.2 System Function

- PLC: Packet loss concealment
- VAD: Voice activity detection
- CNG: Comfort Noise Generation
- Local/Remote SIM card work mode
- Adjustable gain of port
- DTMF adjustment
- Balance Check
- Lock/unlock SIM/UIM
- Mobile number display rejection
- Sending/receiving SMS
- Customize IVR Recording
- White and black list
- One number access
- Open API for SMS, support USSD
- Echo Cancellation (with ITU-T G.168/165 standard)
- Automatic negotiate network
- Hotline
- BCCH

1.4.3 Industrial Standards Supported

- Stationary use environment: EN 300 019: Class 3.1
- Storage environment: EN 300 019: Class 1.2
- Transportation environment: EN 300 019: Class 2.3
- Acoustic noise: EN 300 753
- CE EMC directive 2004/108/EC
- EN55022: 2006+A1:2007
- EN61000-3-2: 2006,
- EN61000-3-3: 1995+A1: 2001+A2: 2005
- EN55024: 1998+A1: 2001+A2: 2003
- Certifications: FCC, CE

1.4.4 General Hardware Specification

- Power Supply
Input: 100-240V, 50-60Hz
- Temperature(Operation): 0 °C ~ 45 °C
(Storage): -20 °C ~80 °C
- Operation Humidity: 10%-90% No Condensation

2. Installation Guide

This chapter mainly introduces DVG-6008G hardware installation as example and connection of device.

2.1 Installation Notice

DVG-6008G-4/8G/Cadapts 12VDC. Power adapter, make sure AC power supply grounded well to ensure the reliability and stability;

Notes: incorrect power connection may damage power adapter and device.

DVG-6008G-4/8 G/Cprovides standard RJ45 with 10Mbps or 100Mbps interfaces.

For Wireless part,make sure antennas connecting well on device. Inserting SIM cardsand GSM channels should work properly.

2.2 Installation Procedure

2.2.1 Install SIM Card

Figure 2-2-1 SIM Card installation



2.2.2 Antenna Installation

Figure 2-2-4 Antenna Installation



2.2.3 Network Cable Connection of Equipment

Figure 2-2-5DVG-6008G networkconnection

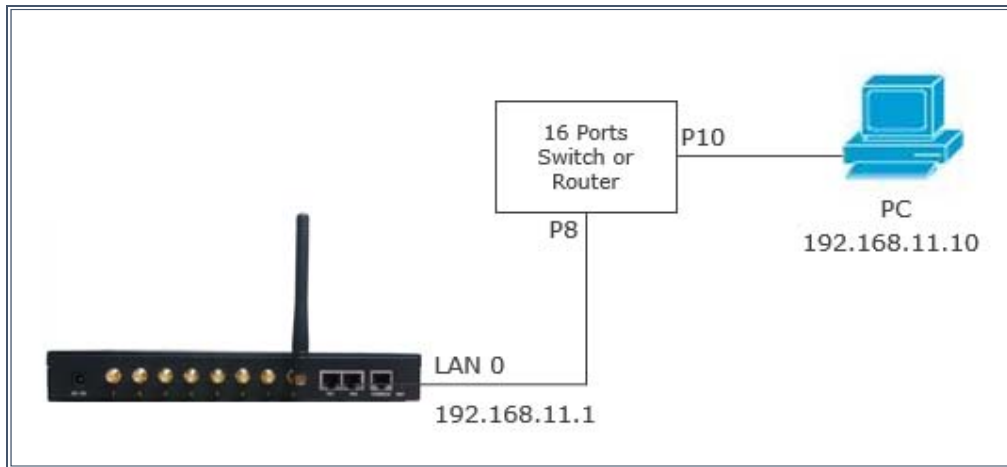

3. Basic Operation

In this chapter is mainly to introduce basic operation of gateway.

3.1 IVR Navigator

The gateway is embeded IVR system for local maintainance.In each step, if user hears an IVR message of “setting succeed”, which means that user has finished this step successfully. However, if user hears a “setting failed” message, please check and redo that step again.

Table 3-1 Feature codes for system setting

Dial numbers	Features
*150*a#	Set IP address(static/DHCP), a can be digit 1 or 2,*150*1# is static IP address mode, *150*2# is DHCP mode
*152*a*b*c*d#	Configure IP address, a, b, c, d are the four fields of IP address.
*153*a*b*c*d#	Configure subnet mask. a, b, c, d are the four fields of the subnet mask
*156*a*b*c*d#	Configure the device gateway, a, b, c, d are the four fields of the device gateway
*158#	Query the IP address
*111#	Restart device

3.2 Basic Operation

3.2.1 Check IP address

With a Mobile phone call the SIM card number, the gateway will answer and play voice prompt ‘dial the extension number’, press *158# on mobile phone then local IP address will be reported by gateway automatically.

3.2.2 Restore factory setting via IVR

With a Mobile phone call the SIM card number, the gateway will answer and play voice prompt ‘dial the extension number’, press *166*000000# on mobile phone then the user will hear ‘setting succeed’. Reboot gateway to take setting effective.

3.2.3 Restore default IP and password

Press RST button about 3 seconds then reboot gateway. The IP address, username and password will be back to factory default.

3.2.4 Restore factory setting

Press RST button about 7 seconds then reboot gateway then it will restore to factory setting.

3.2.5 Console port access

The gateway provide Console port for maintenance purpose. It adopts RS232 standards with band rate 115200bps.

4. WEB Interface Configuration

This chapter describes web configuration of DVG-6008G. The DVG-6008G contains an embedded web server to set parameters by using the HTTP protocol. We are strongly recommend to access device with Google Chrome or Firefox Browser.

The configuration introduction also suitable for following models:

- ▶ DVG-6008G-4G
- ▶ DVG-6008G-8G

4.1 AccessDVG-6008G unit

Enter IP address of DVG-6008G in IE/Google Chrome. The default IP of LAN port is 192.168.11.1. and the GUI shows as below:

Figure 4-1-1 WEB log interface

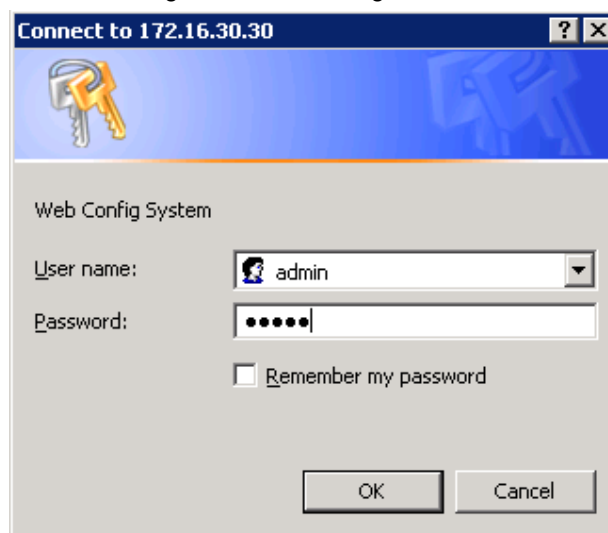

Enter username and password and then click “OK” in configuration interface. The default username and password are “admin/admin”. It is strongly recommended, change the default password to a new password for system security.

4.2 Parameters Configuration

DVG-6008GWEB configuration interface consists of the navigation tree and the detail configuration interfaces.

Figure 4-2-1 WEB introduce

The screenshot shows the D-Link configuration interface. On the left is a navigation tree with categories like System Information, Network Configuration, Mobile Configuration, etc. The main area displays three sections:

- Run Information:**
 - MAC Address: F8-A0-3D-48-36-7E
 - Network Mode: Bridge
 - Network: 192.168.11.1, 255.255.255.0, Static
 - DNS Server: 0.0.0.0
 - Device ID: db00-0030-3d02-7624
 - Server Register Status: Not Registered
 - License: Valid
 - System Up Duration: 2 m 49 s
 - Network Traffic Statistics: Received 21583 Bytes, Sent 30368 Bytes
 - Version Information: Device Model (DVG-6008G), Package Version (60230807 2014-04-09 14:56:54 official), Software Version (60230807 2014-04-09 14:56:32)
- Mobile Information:**

Port	Type	IMSI	IMEI	Status	Remaining Call Duration	Carrier	Signal Quality	BER (%)	ASR (%)	ACD (s)	PDD (s)	Call Status
0	GSM		862106022548434	No SIM Card	No Limit		T	0	0	0	0	Idle
1	GSM		862106023684943	No SIM Card	No Limit		T	0	0	0	0	Idle
2	GSM		862106023682380	No SIM Card	No Limit		T	0	0	0	0	Idle
3	GSM		862106023681465	No SIM Card	No Limit		T	0	0	0	0	Idle
4	UNKNOWN			No Limit	No Limit		T	0	0	0	0	Idle
5	UNKNOWN			No Limit	No Limit		T	0	0	0	0	Idle
6	UNKNOWN			No Limit	No Limit		T	0	0	0	0	Idle
7	UNKNOWN			No Limit	No Limit		T	0	0	0	0	Idle
- SIP Information:**

Port	SIP User ID	Register Status	Status	Port	SIP User ID	Register Status	Status
0		Unregistered	onhook	1		Unregistered	onhook
2		Unregistered	onhook	3		Unregistered	onhook
4		Unregistered	onhook	5		Unregistered	onhook
6		Unregistered	onhook	7		Unregistered	onhook

Go through navigation tree, user can check, view modify, and set the device configuration on the right of configuration interface.

4.3 System Information

System information interface shows the basic information of status information, Mobile information and SIP information.

4.3.1 System Information

Figure 4-3-1 system Information

Run Information			
MAC Address	F8-A0-3D-48-36-7E		
Network Mode	Bridge		
Network	192.168.11.1	255.255.255.0	Static
DNS Server	0.0.0.0		
Device ID	db00-0030-3d02-7624		
Server Register Status	Not Registered		
License	Valid		
System Up Duration	3 m 46 s		
Network Traffic Statistics	Received 21583 Bytes	Sent 39368 Bytes	
Version Information	Device Model	DVG-6008G	
	Package Version	60230807 2014-04-09 14:59:54 official	
	Software Version	60230807 2014-04-09 14:56:32	

Table 4.3-1 System Information

Parameters	Description
MAC Address	Displays the current MAC of the gateway, for example: 00-1F-D6-1B-3D-02
Network Mode	DVG-6008G works as bridge mode by default
Network	Current IP address and subnet mask of gateway
DNS Server	Displays DNS server IP address in the same network with the gateway
Device ID	A unique device ID which assigned in factory. This device ID to be used as register ID with D-Link SIM cloud.
Server Register status	Its indicates communicate status with SIMCloud server, there are two type of status: <ul style="list-style-type: none"> ▶ Registered ▶ Not Registered ▶ Need Authentication
License	Its indicates device's license status. Contact with support when it display as Invalid
System Up Time	Shows the time period of the device running. For example,;1h: 20m, 24s
Traffic Statistics	Calculates the net flow, including the total bytes of message received and sent.
Version info	shows the current firmware version <ul style="list-style-type: none"> • Device Model: Model name of the device • Package version: 02230804 2013-05-29 18:51:05 beta,02230804 is the version number • Software version: 02230804 2013-05-29 18:50:18, 02230804 is the version number • Web version: the version number of web system.The web version must match with software • Userboard 0 Version: the firmware version of userboard slot 0 • Userboard License ID: Contact with support when it display as Invalid • Hardware version/DSP version/ SIMbox version

4.3.2 Mobile Information

Figure 4.3-2 Mobile Information

Mobile Information												
Port	Type	IMSI	IMEI	Status	Remaining Call Duration	Carrier	Signal Quality	BER	ASR(%)	ACD(s)	PDD(s)	Call Status
0	GSM	460004122170725	863070010384344	Mobile Registered	No Limit	CHINA MOBILE	Y	0	0	0	0	Idle
1	GSM	460020187266423	863070010384310	Mobile Registered	No Limit	CHINA MOBILE	Y	0	0	0	0	Idle
2	GSM		863070010385747	No SIM Card	No Limit		Y	0	0	0	0	Idle
3	GSM		863070010385549	No SIM Card	No Limit		Y	0	0	0	0	Idle
4	GSM		863070011821336	No SIM Card	No Limit		Y	0	0	0	0	Idle
5	GSM		863070011821880	No SIM Card	No Limit		Y	0	0	0	0	Idle
6	GSM		863070011899175	No SIM Card	No Limit		Y	0	0	0	0	Idle
7	GSM		863070011764668	No SIM Card	No Limit		Y	0	0	0	0	Idle

Table 4.3-2 Mobile Information

Parameters	Description
Port	Number of GSM/CDMA ports.
Type	Indicates the current type of network. Such as CDMA or GSM
IMSI	International Mobile Subscriber Identity, it is the uniquely identifies of SIM card
Status	Indicates the connection status of current GSM / CDMA module
Remaining Call Duration	It showing available total call minutes of SIM card while call limitation is enabled.
Carrier	Displays the network carrier of current SIM card.
Signal Quality	Displays the signal strength of in each channels of GSM / CDMA.
BER	Its indicate error rates between Module and Base station(BTS)
ASR	Answer Seizure Ratio is a measure of network quality. It's calculated by taking the number of successfully answered calls and dividing by the total number of calls attempted. Since busy signals and other rejections by the called number count as call failures, the ASR value can vary depending on user behavior.
ACD	The Average Call Duration (ACD) is calculated by taking the sum of billable seconds (bill sec) of answered calls and dividing it by the number of these answered calls.
PDD	Post Dial Delay (PDD) is experienced by the originating customer as the time from the sending of the final dialed digit to the point at which they hear ring tone or other in-band information. Where the originating network is required to play an announcement before completing the call then this definition of PDD excludes the duration of such announcements.
Call Status	Show the Status of port, include idle, active, alert and processing <ul style="list-style-type: none"> • <i>Idle</i> means there is no call on this channel • <i>Processing</i> means call is connecting • <i>Alerting</i> means destination is ringing • <i>Active</i> means the call is connected

- *Ringin*g means the gateway is answering incoming call from mobile
- *Callin*g Waiting means the gateway is receiving another call during conversation and implement call waiting service
- *Call Hold* means the call is hold by extension of IPPBX/SIP Server

4.3.3 SIP Information

Figure 4-3-3 SIP Information

SIP Information							
Port	SIP User ID	Register Status	Status	Port	SIP User ID	Register Status	Status
0	2001	Unregistered	onhook	1	2001	Unregistered	onhook
2	2001	Unregistered	onhook	3	2001	Unregistered	onhook
4	2001	Unregistered	onhook	5	2001	Unregistered	onhook
6	2001	Unregistered	onhook	7	2001	Unregistered	onhook

Refresh

Displays registration status information with Softswitch platform or SIP Server

Table 4-3-3 SIP information

Parameters	Description
Port	The number of SIP channels, DVG-6008G-8G/C has 8 SIP channels
SIP User ID	SIP registration account which are provided by the Softswitch and SIP server
Register Status	Shows the registration status of VoIP channel, including registered and unregistered.
Status	Show the status of port, Include "onhook" and "offhook"

4.4 Statistics

4.4.1 TCP/UDP

Figure 4-4-1 TCP/UDP Statistics

TCP/UDP			
TCP Send Packet	TCP Recv Packet	UDP Send Packet	UDP Recv Packet
1946619	686236	221687	0

Refresh

4.4.2 RTP

Figure 4-4-2 RTP

RTP										
Port	Payload Type	Packet Period	Local Port	Peer IP	Peer Port	Send Packet	Recv Packet	Loss Packet	Jitter	Duration Time(s)
---	---	---	---	---	---	---	---	---	---	---

[Refresh](#)

Table 4-4-1 Description of RTP Statistics

Parameters	Description
Port	The port of RTP statistics
Payload Type	The voice code of this channel, Include G.723.1/PCMA/PCMU/G.729AB
Packet Period	Time of packaging
Local Port	Local port of transmitting RTP packages
Peer IP	End of equipment IP address
Peer Port	Peer port of receiving RTP packages
Send Packet	Total of sending RTP packages
Recv Packet	Total of receiving RTP packages
Loss Packet	Total of losing RTP packages
Jitter	Length of delay jitter
Duration Time(s)	Both ends of the call time

4.4.3 SIP Call History

Figure 4-4-3 SIP Call History

SIP Call History								
Port	Incoming Received	Incoming Connected	Incoming Answered	Incoming Failed	Outgoing Attempted	Outgoing Connected	Outgoing Answered	Outgoing Failed
0	55	55	55	0	48	0	23	25
1	28	28	28	0	2	0	0	2
2	0	0	0	0	0	0	0	0
3	0	0	0	0	0	0	0	0
4	0	0	0	0	0	0	0	0
5	0	0	0	0	0	0	0	0
6	0	0	0	0	0	0	0	0
7	0	0	0	0	0	0	0	0

[Refresh](#)

Table 4-4-2 SIP Call History

Parameters	Description
Port	The port of Call statistics
Incoming Received	The amount of received incoming calls which coming from IP side
Incoming connected	The amount of incoming calls which have connected
Incoming Answered	The amount of incoming calls which answered by GSM/CDMA module
Incoming Failed	The amount of incoming calls which failed
Outgoing Attempted	The amount of outgoing calls which attempted to IP side

Outgoing Connected	The amount of outgoing calls which have connected
Outgoing Answered	The amount of outgoing calls which answered by IP side
Outgoing Failed	The amount of outgoing calls which failed

4.4.4 IP to GSM Call History

Figure 4-4-4 IP to GSM Call History

IP to GSM Call History												
Port	Call	Duration	Answered	Call Failed Caused by SIP				Call Failed Caused by GSM				OTHER
				Canceled	Timeout	Not Allowed	Negotiation failed	Busy	NO ANSWER	NO DIALTONE	NO CARRIER	
0	55	2179	16	25	0	0	0	0	0	2	12	0
1	28	1036	6	15	0	0	0	0	0	4	3	0
2	0	0	0	0	0	0	0	0	0	0	0	0
3	0	0	0	0	0	0	0	0	0	0	0	0
4	0	0	0	0	0	0	0	0	0	0	0	0
5	0	0	0	0	0	0	0	0	0	0	0	0
6	0	0	0	0	0	0	0	0	0	0	0	0
7	0	0	0	0	0	0	0	0	0	0	0	0

Table 4-4-4IP to GSM Call History

Parameters	Description
Port	Device GSM port
Call	Statistics the number of calls in this port
Duration	Statistics call total time
Answered	Statistics response times
Call Failed Caused by SIP	Statistics cause of call failure from SIP, include:canceled/timeout/not allowed/Negotiation failed
Call Failed Caused by GSM	Statistics cause of call failure from GSM, include: Busy/ no answer/ no dialtone/ no carrier

4.4.5 CDR Report

Figure 4-4-5CDR Report

Port	Start Date	Answer Date	Call Direction	Source	Destination	Status	Duration(s)	Rtp Send	Rtp recv	Rtp loss Rate	Jitter(s)
4	2013/06/19 15:14:49	2013/06/19 15:14:59	IP->Gsm	1955555123	01850594108	ANSWERED	39	764	2212	0%	0

It is support 10000 CDRs on gateway. The CDRs will lost after reboot while save CDR set to No. To make the device works in good performance,we are strongly recomand to set 'Save

CDR' to No.

Port	Start Date	Answer Date	Call Direction	Source	Destination	Status	Duration(s)	Rtp Send	Rtp recv	Rtp loss Rate	jitter(s)
4	2013/06/19 15:14:49	2013/06/19 15:14:59	IP->Gsm	1955555123	01850594108	ANSWERED	39	764	2212	0%	0
4	2013/06/19 15:15:49		IP->Gsm	1955555123	01746039247	CANCELED	0	83	270	0%	0
2	2013/06/19 15:15:37		IP->Gsm	1955555123	01818910940	CANCELED	0	686	948	0%	0
8	2013/06/19 15:05:36	2013/06/19 15:05:48	IP->Gsm	1955555123	01710663894	ANSWERED	633	20067	31111	0%	0
0	2013/06/19 15:15:12	2013/06/19 15:15:33	IP->Gsm	1955555123	01840283671	ANSWERED	52	1174	3424	0%	0
8	2013/06/19 15:16:35		IP->Gsm	1955555123	019528783740	NO CARRIER	0	198	222	0%	0
8	2013/06/19 15:16:46		IP->Gsm	1955555123	019528783740	CANCELED	0	0	0	0%	0
2	2013/06/19 15:16:19		IP->Gsm	1955555123	01770924823	NOT ANSWERED	0	409	1225	0%	0

Parameters	Description
Port	GSM port number
Start Date/Answer Date	start and end time of calls
Direction	IP to GSM: outbound calls from softswitch/IPPBX to mobile network GSM to IP: incoming calls from mobile network to IPPBX/ Softswitch
Source	Calling number
Destination	Called number
Stauts	Answered: the call was established successful Canceded: the call was canceled by calling party No Carrier: the call was rejected by mobile network Not Answered: no body to answer the call Busy: user busy
Durations	Call duration of the call
RTP send/recv/loss rate	RTP Statistics of the call

4.4.6 Auto Lock BCCH History

Figure 4-4-6 Auto Lock BCCH History

Auto Lock BCCH History			
Select Port		Port 0 ▾	
Index	BCCH	Signal Strength	Time
1	798	-73	2013-06-19 03:40:32

Recently 50 Times Record

It is record history of BCCH to help analysis SIM card register status.

4.5 Network Configuration

4.5.1 Local Network

Figure 4-5-1 Local Network

Local Network

Network Configuration

Obtain IP address automatically

Use the following IP address

IP Address

Subnet Mask

Default Gateway

PPPoE

Account

Password

Service Name

MTU

DNS Server

Obtain DNS server address automatically

Use the following DNS server addresses

Primary DNS Server

Secondary DNS Server

Table 4-5-1 Local network

Parameters	Description
Obtain IP Address Automatically	Enable the device obtain IP Address automatically or not. Default is enabling
Use the Following IP Address	Configure the "IP Address", "Subnet Mask" and "Default Gateway" by manual
PPPoE	Need ISP offer the account and password, Use this mode when there is not router in the local network
MTU	Message transmit unit, default is 1400
Obtain DNS Server Address Automatically	When enable the WAN port option of "Obtain DNS Server Address Automatically", which will be enabled subsequently.
Use the Following DNS Server Addresses	Fill in the IP address of "Primary DNS Server" and "Secondary DNS Server"

4.5.2 ARP

The ARP function mainly used to query and add the map of IP and MAC. There are static or dynamic ARP entries.

Like other routers, the gateway can automatically find the network device on the same segment. But, sometimes you don't want to use this automatic mapping; you'd rather have fixed (static) associations between an IP address and a MAC address. Gateway provides you the ability to add static ARP entries to:

- Protect your network against ARP spoofing
- Prevent network confusion as a result of misconfigured network device

Figure 4-5-3 Add ARP

Add ARP

IP Address

MAC Address

The IP format is: xxx.xxx.xxx.xxx
The MAC format is: xx-xx-xx-xx-xx-xx

Click *Search All* to check ARP buffer.

ARP

Type static dynamic

	IP Address	MAC Address
<input type="checkbox"/>	172.16.221.43	BC-AE-C5-4E-15-F5
<input type="checkbox"/>	172.16.236.129	2C-D0-5A-12-D5-2A
<input type="checkbox"/>	172.16.10.10	00-0C-29-08-3D-91

4.5.3 VPN Parameter

Figure 4-5-3 VPN Parameter

VPN Parameter

VPN Enable

Server

Account

Password

Domain

Use MPPE

Table 4-5-3 Description of VPN Parameter

Parameters	Description
Server	VPN Server IP or domain name(support PPTP only)
Account	VPN account which provide by server or VPN provider
Password	Password of VPN which provide by server or VPN provider
Domain	Follow VPN setting, can be null
Use MPPE	Encryption parameter, support 40/128 bit, must be match with VPN server

Check VPN connecting status on system information

Run Information			
MAC Address	00-12-34-56-78-00		
Network Mode	Bridge		
Network	0.0.0.0	0.0.0.0	Static
DNS Server	8.8.8.8	0.0.0.0	
Device ID	0000-0000-0000-0000		
Server Register Status	Not Registered		
VPN Connection Status	Connecting		
VPN Server	us1.suvpn.com		
VPN Local IP			
VPN Remote IP			

4.6 Mobile Configuration

4.6.1 Basic Configuration

Figure 4-6-1 Basic Configuration

Basic Configuration	
Dial Tone Gain (Mobile Side)	<input type="text" value="8"/> dB
Select Band	<input type="text" value="Default(Automatic)"/>
Forward Enable	<input checked="" type="radio"/> No <input type="radio"/> Yes
Remote API Enable	<input type="radio"/> No <input checked="" type="radio"/> Yes
API Server Address	<input type="text" value="172.16.221.221"/>
API Server Port	<input type="text" value="12000"/>
API User ID	<input type="text" value="aabbcc"/>
API User Password	<input type="text" value="*****"/> <input type="button" value="Show Password"/>
Transmitted Power	<input type="text" value="0"/>
USSD Default Encoding	<input type="text" value="UCS2"/>
Voice Quality	<input type="text" value="7"/>
Abnormal Call Handle Enable	<input checked="" type="radio"/> No <input type="radio"/> Yes

Table 4-6-1 Description of Basic Configuration

Parameters	Description
Dial Tone Gain	It is the dial tone volume of call waiting, dial tone of mobile module when call out. Usually adopt the default configuration.
Select Band	According to carrier's band standards. Standards are as below: GSM: 850/900/1800/1900 MHz Notes: it is take effective for GSM only
Forward Enable	When port occupied whether allow call forwarding
Forward Master Mobile	Choose the destination port to be forwarded
Remote API Enable	API is an opened protocols which provide to users to develop third party application software such as bulk SMS, SIM card management etc. The default is "No".
API Server Address	It is the remote IP address of application software/ API server. This is an option when selecting "Yes" under 'remote API enable'.
API Server Port	To define communicate port between gateway and API server. This is an option when selecting "Yes" under "remote API enable"
API User ID/Password	To define authentication user name and password between gateway and API server.
Transmitted Power	Transmit power of module. Use the default setting value and contact with technical support if need to change it.
USSD Defaulting Encoding	Encoding of USSD, default is UCS2.
Voice Quality	Keep the parameter as default except the device is facing low ASR issue. To adjust voice quality level possibly help to improve low ASR issue but may affect voice quality.
Abnormal Call handle	It is an optional parameter to handle abnormal calls.

Notes: please reference API document for more details.

Example:▶ **Configuration between SMS box and gateway**

▶ Configure API parameters on gateway

Remote API Enable	<input type="radio"/> No <input checked="" type="radio"/> Yes
API Server Address	172.16.221.221
API Server Port	12000
API User ID	aabbcc
API User Password <input type="button" value="Show Password"/>

The IP server which installed SMS box software is 172.16.221.221, pre-set Port12000, User ID aabbcc and password abc123 as example.

▶ Configure SMS box

(Next Page)

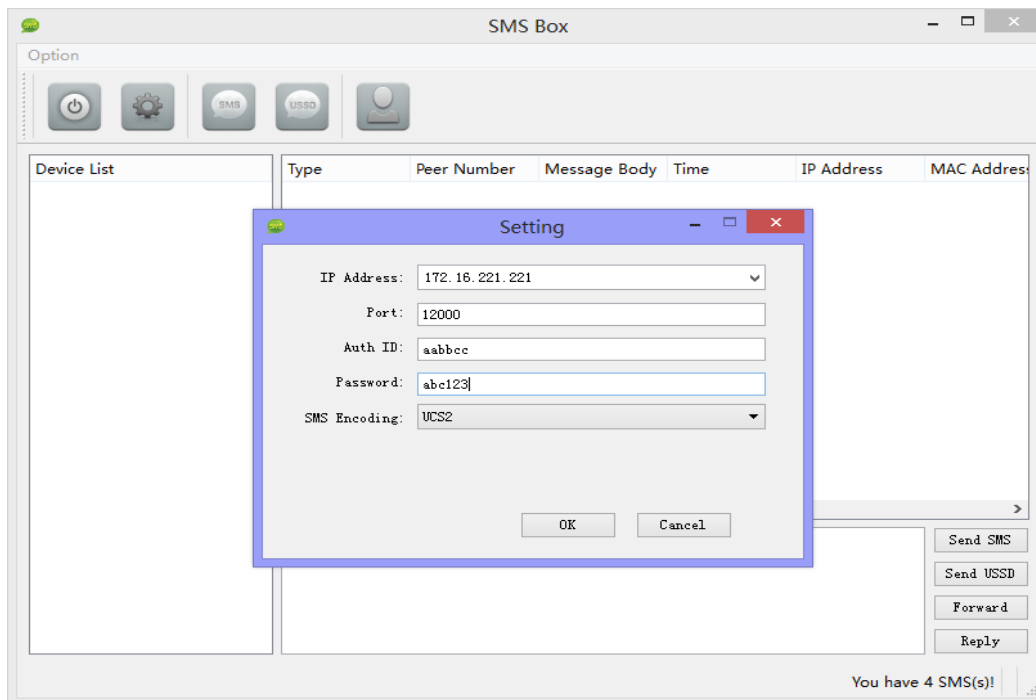

Then click **OK** and start service, the gateway IP will be presented in device list of SMS box

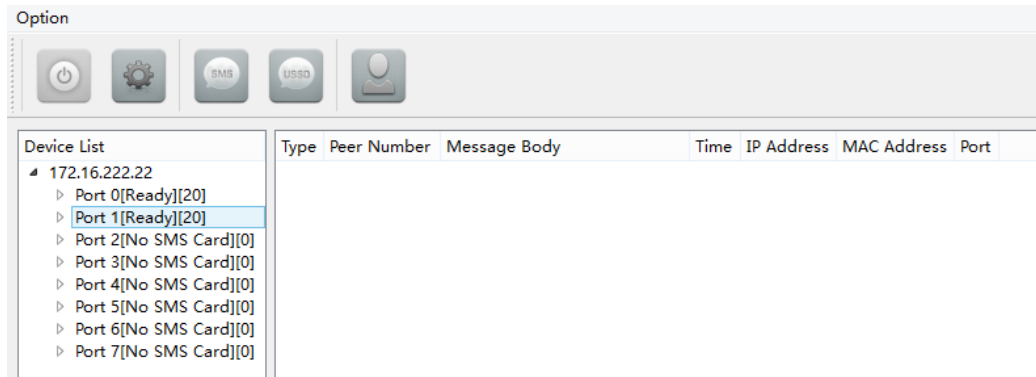

► how to configure abnormal call on gateway

Here is example of abnormal call setting

Abnormal Call Handle Enable	<input type="radio"/> No <input checked="" type="radio"/> Yes
<input checked="" type="checkbox"/> Low ASR Less Than	20 %
Recent Call Times	100
<input checked="" type="checkbox"/> Low ACD Less Than	300 s
Recent Connected Call Times	80
<input checked="" type="checkbox"/> Counts of Call Failed	10
Module Operate	<input checked="" type="radio"/> Reset <input type="radio"/> Block
<input checked="" type="checkbox"/> Send SMS For Alerting	13800138000

►Low ASR Less Than 20%

statistics 100 calls, auto-reset/block module while ASR less than 20%

►Low ACD Less Than 300s

statistics 80 calls, auto-reset/block module while ACD less than 300 seconds

►Counts of Call Failed

auto-reset block module while 10times fail to call to mobile network continuously

►Mobile Operate

reset module to register again to mobile network. Block means won't call out via this module any more unless unblock it

4.6.2 Mobile Configuration

Figure 4-6-2 Mobile State

Mobile State						
Port	Single Call Limitation	Call Limitation	Tx Gain	Rx Gain	Reset Module	Detail
0	No	No	3	7	Reset Module	Detail
1	No	No	3	7	Reset Module	Detail
2	No	No	3	7	Reset Module	Detail
3	No	No	3	7	Reset Module	Detail
4	No	No	3	7	Reset Module	Detail
5	No	No	3	7	Reset Module	Detail
6	No	No	3	7	Reset Module	Detail
7	No	No	3	7	Reset Module	Detail

Figure 4-6-3 Mobile Configuration

Mobile Configuration

Select Port: Port 0 ▼

Mobile Number:

Step: sec

Enable Call Duration Limitation of single call: No Yes

Time of single call:

Enable Call Duration Limitation: No Yes

Auto Reset: No Yes

Maximum Call Duration:

Minimum Charging Time: sec

Alarm Threshold (via SMS):

Mobile Number (Receiving Alarm):

Port Description for Alarm:

Remain Time:

[Restore Time](#)

CLIR: No Yes

Mobile Tx Gain: dB

Mobile Rx Gain: dB

[Reset Module](#)

NOTE: 1.If the duration of a call is less than 'Minimum Charging Time', it will be not included in 'Call Duration'.
 2.Check the anti-pole signal is only effective on the CDMA.

Table 4-6-2 Description of Mobile Configuration

Parameters	Description
Mobile Number	SIM card number of the channel. That must be configured when "Forward" function enable.
Step	Step length value range is 1-120 s, step length multiplied by time of single call just said a single call duration time allowed.

Enable Call Duration Limitation single call	Define maximum call duration for single call. Example: if Time of single call set to 10, the call will be disconnected after talking 10*step seconds
Time of single call	The value of limitation single call, this value range is 1-65535. Step length multiplied by time of single call just said a single call duration time allowed.
Enable Call Duration Limitation	This function is to limit the max call duration of channel. The max call duration is between 1 to 65535 steps.
Auto reset	Set a time make device reboot
Maximum Call Duration	Defines a value by users. That will limit the SIM/UIM card's total call duration. After the call duration exceeds this value, no call will be made from this channel. The value range is 1-65535. If user doesn't configure this value, Default is no max call duration limits for this channel.
Minimum Charging Time	A minimum charging time (in seconds) is defined during which no charging is done at carrier side. If the conversation time is even shorter, the total call duration will not decrease.
Alarm Threshold (via SMS)	When the SIM remain time is or less than this value, DWG will send the alarm SMS to remind the users of the SIM remain time.
Mobile Number (Receiving Alarm)	The mobile phone No. which used to receive the alarm SMS. Users can get SMS report of SIM/UIM card status (SIM Remain Time) in DWG.
Port Description for Alarm	It is the identification mark of SIM/UIM card in the SMS report. The mobile phone No. of the SIM/UIM card is recommended to use as the port description for alarm, or any other string.
Remain Time	Indicates the current SIMremain time. It can't modified
Restore time	Recovers the SIM remain time to initial value, the Maximum Call Duration.

CLIR	Caller ID display restrict. This function is used to restrict the mobile phone No. By adding “#31#” before the mobile phone ID, this function should be supported by carrier.
Mobile Tx Gain	Transits gain of the mobile module, from IP side to PSTN side.
Mobile Rx Gain	Receives gain of the mobile module, from PSTN side to IP side.

► **How to configure maximum call limitation**

►Preset: 1200 minutes (Ct) for each SIM

► Case1. The SIM card billing every 60s (Cu)

So we have to configure maximum call duration as below:

Step = Cu = 60s;

Maximum Call Duration = total call minutes of SIM (minutes) * 60s / step = Ct * 60 /

Cu =1200 * 60 / 60 = 1200 step

Select Port: Port 0

Mobile Number: []

Step: 60 sec

Enable Call Duration Limitation of single call: No Yes

Enable Call Duration Limitation: No Yes

Auto Reset: No Yes

Maximum Call Duration: 1200

Minimum Charging Time: 0 sec

Alarm Threshold (via SMS): 0

►Case2. The SIM card billing every 6s (Cu)

So we have to configure maximum call duration as below:

Step = Cu = 6s

Maximum Call Duration = total call minutes of SIM (minutes) * 60s / step = Ct *60 / Cu = 1200

*60 / 6 =12000 step

Mobile Number	<input type="text"/>
Step	<input type="text" value="6"/> sec
Enable Call Duration Limitation of single call	<input checked="" type="radio"/> No <input type="radio"/> Yes
Enable Call Duration Limitation	<input type="radio"/> No <input checked="" type="radio"/> Yes
Auto Reset	<input checked="" type="radio"/> No <input type="radio"/> Yes
Maximum Call Duration	<input type="text" value="12000"/>
Minimum Charging Time	<input type="text" value="0"/> sec
Alarm Threshold (via SMS)	<input type="text" value="0"/>
Mobile Number (Receiving Alarm)	<input type="text"/>

4.6.3 PIN Management

Figure 4-6-4 PIN Management

PIN Management	
Select Port	<input type="text" value="Port 0"/> ▼
SIM Card Lock	<input checked="" type="radio"/> No <input type="radio"/> Yes
PIN Code	<input type="text" value="*****"/>

Table 4-6-3 Description of PIN Management

Parameters	Description
PIN	Personal identification number of SIM card. In the status of SIM card locked, PIN can be modified to prevent SIM card from being stolen.
Select Port	Selects the GSM/CDMA channel number

4.6.5 SMSC

Figure 4-6-5 SMSC

SMSC	
Select Port	<input type="text" value="Port 0"/> ▼
SMSC	<input type="text" value="+8613800755500"/>

SMS center of mobile, in most places, the cellular module will automatically detect the SMSC number. This configurable option is used in a situation that the SMSC number could not be detected by the cellular module. When such a case happens, please contact with the mobile service provider to identify the SMSC number and then add the SMSC number in the SMSC configurable web interface.

4.6.6 Send SMS/Recv SMS

Figure 4-6-6 Send SMS

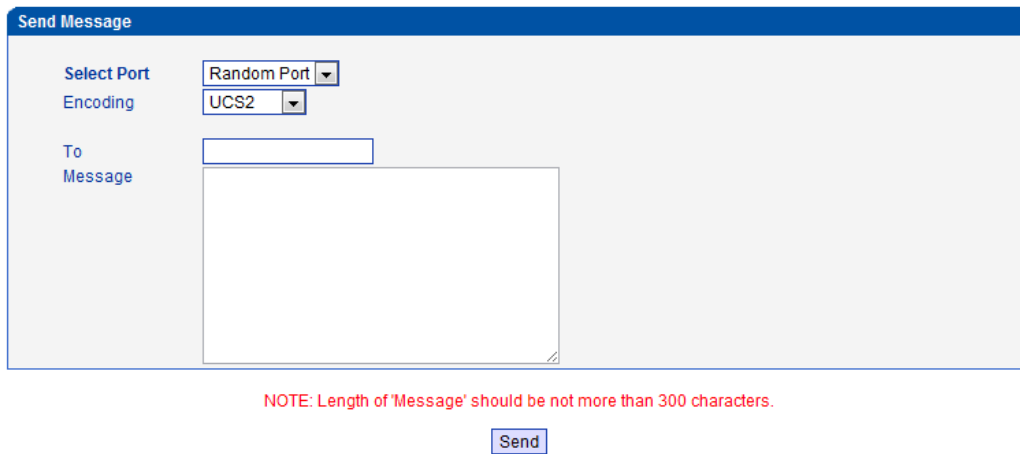

Send Message

Select Port: Random Port

Encoding: UCS2

To: [Text Input]

Message: [Text Area]

Send

NOTE: Length of 'Message' should be not more than 300 characters.

Table 4-6-5 Description of SMS sending

Parameters	Description
Select Port	Users can select a defined channel or random channel to send SMS. Input the receiver's mobile phone No to send SMS.
Encoding	Two kinds of message encoding under PDU models, 7-bit encoding and UCS2 encoding. Default is UCS2.
To	Mobile phone No. of the receiver
Message	Content of the SMS. The length is limited to 300 characters.

4.6.7 USSD

USSD (Unstructured Supplementary Service Data) is a Global System for Mobile(GSM) communication technology that is used to send text between a mobile phone and an application program in the network. Applications may include prepaid roaming or mobile chatting.

Figure 4-6-7 USSD

USSD		
Port	USSD Request	USSD Reply
<input checked="" type="checkbox"/> 0	*222#	UNKNOWN APPLICATION
<input checked="" type="checkbox"/> 1	*222#	UNKNOWN APPLICATION
<input checked="" type="checkbox"/> 2	*222#	not registered
<input checked="" type="checkbox"/> 3	*222#	not registered
<input checked="" type="checkbox"/> 4	*222#	not registered
<input checked="" type="checkbox"/> 5	*222#	not registered
<input checked="" type="checkbox"/> 6	*222#	not registered
<input checked="" type="checkbox"/> 7	*222#	not registered

All *222#

Table 4-6-6 Description of USSD

Parameters	Description
Port	Select the GSM channel to send USSD
USSD Reply	Display results of USSD
USSD Request	Display the result of sending USSD

4.6.8 Carrier

Figure 4-6-8 Select Carrier

Carrier	
Select Port	Port 0
Select Mode	<input type="radio"/> Automatic <input checked="" type="radio"/> Manual
Carrier List	CHINA MOBILE

This function is used to select carrier.

Table 4-6-6 Description of select Carrier

Parameters	Description
Select Port	Select GSM channel,default Port 0
Select Mode	There are two modes to select carrier automatic and manual. Automatic mode can be automatically search operators. Manual mode can choose operators from the carrier list.
Carrier List	If you select manual mode, you can select carrier from carrier list.

4.6.9 BCCH

Figure 4-6-9 BCCH

BCCH						
Select Port	Port 1					
BCCH Mode	Random					
Minimum Signal Strength allow	-90					db
Auto Period between	5	and	10	min		
Switch BCCH in Calling	<input checked="" type="radio"/> No <input type="radio"/> Yes					
Apply To All Ports	<input checked="" type="radio"/> No <input type="radio"/> Yes					
Index	MCC	MNC	LAC	CID	BCCH	Receive Level
0	460	00	0X2639	0XE88	78	-74

Table 4-6-7 Description of BCCH

Parameters	Description
BCCH Mode	There are four options. Default, Fixed, Random, Advanced
Refresh Interval	Set frequency detection refresh time
Auto Refresh/Stop Refresh	Choose whether to refresh frequency
Index	Serial number
MCC	Mobile country code, China is 460
MNC	Mobile network code, used to distinguish between different network operators
LAC	Location area codes
CID	Cell ID (CID) is a generally unique number used to identify each Base transceiver station (BTS) or sector of a BTS within a Location area code (LAC) if not within a GSM network.
BCCH	broadcast control channel (BCCH) is a point to multipoint, unidirectional (downlink) channel used in the Um interface of the GSM cellular standard
Receive Level	Receiving signal strong strength

Choose a frequency to lock the operations.

4.6.10 Call Forwarding

Call Forwarding

Select Port Port 1 ▾

Select	Call Type	Call Number	
<input type="radio"/>	Call Forwarding Unconditional	<input style="width: 100%;" type="text"/>	Example: 0755-26456659 or 18665808238
<input checked="" type="radio"/>	<input type="checkbox"/> Call Forwarding No Reply	<input style="width: 100%;" type="text"/>	
	<input type="checkbox"/> Call Forwarding Busy	<input style="width: 100%;" type="text"/>	
	<input checked="" type="checkbox"/> Call Forward on Not Reachable	<input style="width: 100%;" type="text" value="+867691255938"/>	
<input type="radio"/>	Cancel All		

Call forwarding is the same as mobile phone which to activate/deactivate supplementary service of SIM card. For more details of these services, please contact to local providers.

4.6.11 Call Waiting

Call Waiting

Select Port Port 1 ▾

Enable No Yes

Call waiting is the same as mobile phone which to activate/deactivate supplementary service of SIM card. For more details of these services, please contact to local providers.

Notes: Call waiting is only take effective while “Do Not Answer GSM Incoming Call for Hotline” set to Yes.

System configuration -> Service Parameter

Do Not Answer GSM Incoming Call for Hotline No Yes

4.6.12 SIM Mode

SIM Mode

SIM Mode Local SIM Box SIM Bank

D-Linkgateway support two types of SIM card installation, which is local and remote SIM management.

Item	Description
Local	To use local SIM card which install on gateway, this way is most common used by many of users
SIMBox	SIM Box is a small box which use for SIM card storage. It ideal

	for users who want replace SIM card frequently
SIMBank	SIM Bank is use for SIM card storage and remote SIM management together with D-Link SIM Cloud

► **What's the difference between SIM Box and SIM Bank?**

Both SIM Box and SIM Bank are used for SIM storage. SIM Box is a simple device which use for remote SIM installation only but not support SIM rotation, NAT traversal etc. it is work with local network only that means gateway and SIM Box must be connected to the same network.

Compare to SIM Box, SIM Bank is most powerful and provide flexible SIM management rules such as SIM Rotation, SIM switching and anti-block policy. It is important component of D-Link SIM cloud solution. With SIM Bank, GSM gateways can be deployed in different locations and countries so that the user are able to supervise all SIMs in one place.

4.6.13 Cloud Server

The Cloud server is normally configured when the gateway work with SIMBank or centralized management purpose.

Parameters	Description
Domain	Unique domain for the users
Port	It is define by SIM Cloud. Default value is 2020
Password	It is create when add gateway on SIM Cloud. The password is use to authentication purpose
Protocol	SCTP, UDP
SIM Transport Type	Auto: the device is chose transport method automatically; Relay: SIM Server work as relay server, all data must be transport by SIM server.

► **How to register gateway to SIM Cloud?**

Example: add gateway on domain support.D-Linkcloud.com

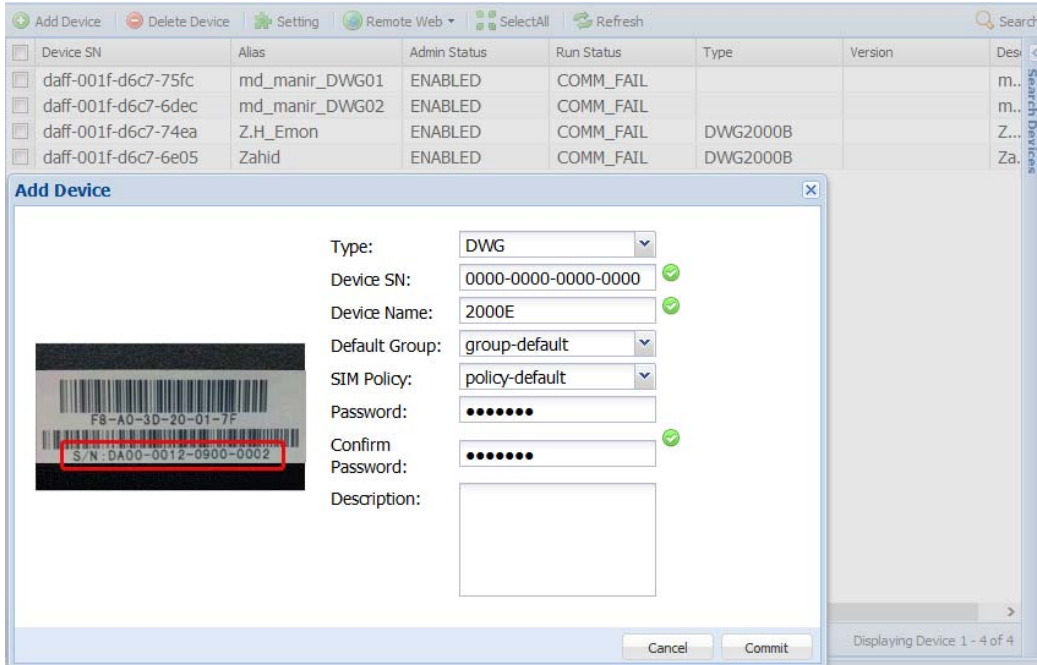

Device S/N is the device ID on gateway, find it on the page **system information**, as below:

Device ID	0000-0000-0000-0000
Server Register Status	Not Registered

4.7 Routing Configuration

4.7.1 Routing Parameter

Figure 4-7-1 Routing Parameter

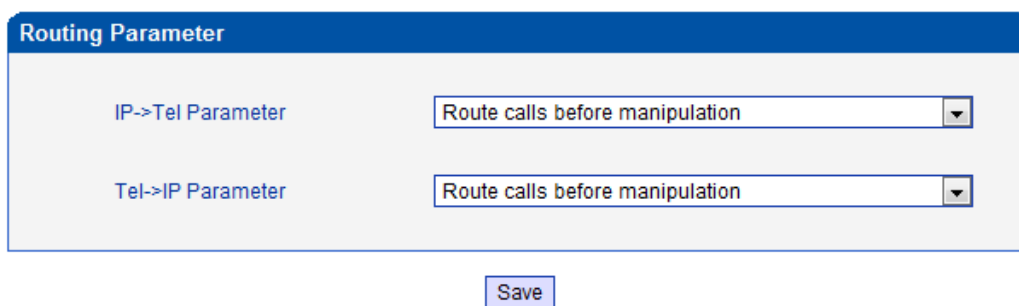

Table 4-7-1 Description of Routing Parameter

Parameters	Description
Tel->IP Parameter	Global parameters, it will take effect while number manipulation configured

Route calls after manipulation	The parameters indicate that the gateway will select Tel->IP routes after number manipulation completed
Route calls before manipulation	The parameters indicate that the gateway will select Tel->IP routes before number manipulation completed

4.7.2 IP->Tel Routing

Figure 4-7-2 IP to Tel Routing

IP->Tel Routing						
Index	Description	Source IP	Source Prefix	Destination Prefix	Destination	
<input type="checkbox"/> 30	Elastix	IP 31	any	[2-9]	Port Group 0	
<input type="checkbox"/> 31	ip-tel	Any	any	any	Port Group 0	

Table 4-7-2 Description of IP to Tel Routing

Parameters	Description
IP ->Tel Routing	This item uses to configure outgoing call routes which can be used for receive the calls from the IP side
Index	It uniquely identifies a route. Its value is assigned globally, ranging from 0 to 31. The route preferentially match the rules which the value of index is smaller. Index 31 is default route on gateway which to be match all prefixes.
Description	It describes the route for the ease of identification. Its value is character string
Source IP	It specifies the IP of the caller
Source Prefix	All the caller number must match the source prefix. It specifies the source prefix allow to send call out <ul style="list-style-type: none"> Any: include anonymous, 0xxxx, 1[2-9]xxxx etc. 0xxxx: consist of some digits such as 015,08,09 1[3-8]6:consist of some prefix, include 136,146,156,166,176, 186
Destination Prefix	All the called number must match the destination prefix, the call prefix indicates the connected number <ul style="list-style-type: none"> Any: include anonymous, 0xxxx, 1[2-9]xxxx etc. 0xxxx: consist of some digits such as 015,08,09 1[3-8]6:consist of some prefix, include 136,146,156,166,176, 186

Destination	Its specifies destination Port or Port Group
-------------	--

4.7.3 Tel->IP Routing

Figure 4-7-3 Tel to IP Routing

Tel->IP Routing						
	Index	Description	Source Port	Source Prefix	Destination Prefix	Destination
<input type="checkbox"/>	31	default	Port Group 0	any	any	SIP Server

Table 4-7-3 Description of Tel to IP Routing

Parameters	Description
Tel -> IP Routing	This item uses to configure incoming call routes which can be used for receive the calls from the mobile.
Index	It uniquely identifies a route. Its value is assigned globally, ranging from 0 to 31. The route preferentially match the rules which the value of index is smaller
Description	It describes the route for the ease of identification. Its value is character string
Source Port	It specifies the Port or Port Group which will receive the calls from mobile
Source Prefix	All the caller number must match the source prefix. It specifies the source prefix allow to send call out <ul style="list-style-type: none"> Any: include anonymous, 0xxxx, 1[2-9]xxxx etc. 0xxxx: consist of some digits such as 015,08,09 1[3-8]6:consist of some prefix, include 136,146,156,166,176, 186
Destination Prefix	All the called number must match the destination prefix, the call prefix indicates the connected number <ul style="list-style-type: none"> Any: include anonymous, 0xxxx, 1[2-9]xxxx etc. 0xxxx: consist of some digits such as 015,08,09 1[3-8]6:consist of some prefix, include 136,146,156,166,176, 186
Destination	Its specifies destination IP trunk or SIP server

Figure 4-7-4 Tel to IP routing Modify

Tel->IP Routing Modify	
Index	31
Description	default
Source Prefix	any
Source	<input type="radio"/> Port 0 <input checked="" type="radio"/> Port Group 0 <group1>
Destination Prefix	any
Destination	<input type="radio"/> Port 0 <input type="radio"/> Port Group 0 <group1> <input type="radio"/> IP <input type="radio"/> IP Group 31 <IPGroups> <input checked="" type="radio"/> SIP Server

It's a default route configured in gateway. It allows any number from source port 0 send call to SIP server with any prefix.

Figure 4-7-5 Add Tel to IP routing

Tel->IP Routing Add	
Index	30
Description	To Elastix
Source Prefix	any
Source Port	<input checked="" type="radio"/> Port 0 <input type="radio"/> Port Group 0 <group1>
Destination Prefix	00
Destination	<input type="radio"/> Port 0 <input type="radio"/> Port Group 0 <group1> <input checked="" type="radio"/> IP 31 <Elastix> <input type="radio"/> IP Group 31 <IPGroups> <input type="radio"/> SIP Server

Add a mobile to VoIP route. It indicates that the calls coming from Port Group 31<Unicom> will match the prefix "x.", "x." is a wildcard string which will match any prefix except "anonymous" calls. Meanwhile sending the calls destination IP 13<eia> if called number match with destination prefix "00".

Figure 4-7-6 Tel to IP routing Modify

Tel->IP Routing Add

Index: 29

Description: A to B

Source Prefix: 13[58]

Source Port:

 Port: 0

 Port Group: 0 <group1>

Destination Prefix: 133

Destination:

 Port: 4

 Port Group: 0 <group1>

 IP: 31 <Elastix>

 IP Group: 31 <IPGroups>

 SIP Server

Add mobile to mobile route, its mainly used for saving the cost between two carriers. It indicates that calls coming from Port 0 will match the prefix 13[58], "13[58]" include prefix 135 and 138, caller number can't match prefix 135 and 138 will reject by gateway. Meanwhile sending the calls to Port Group 31<Unicom> if called number match with prefix 133.

4.8 Manipulation Configuration

4.8.1 IP->Tel Destination Numbers

Figure 4-8-1 IP->Tel destination numbers manipulation

IP->Tel Manipulation											
Index	Description	Source IP	Source Prefix	Destination Prefix	Destination	Stripped Digits from Left	Stripped Digits from Right	Prefix to Add	Suffix to Add	Number of Digits to Leave from Right	
<input type="checkbox"/>	0	saicom	IP Group 31	any	2547	Port Group...	3	0	0	---	---

Total: 1entry 16entry/page 1/1page Page 1

[Add](#) [Delete](#) [Modify](#)

Table 4-8-1 Description of IP->Tel destination numbers manipulation

Parameters	Description
IP->Tel destination numbers manipulation	It is an optional configuration item, and is used to add a rule for changing number

Index	It uniquely identifies a route. Its value is assigned globally, ranging from 0 to 31. The route preferentially match the rules which the value of index is smaller
Description	It describes the rule for the ease of identification. Its value is character string
Source IP	It specifies the source IP which will send the calls to gateway <ul style="list-style-type: none"> • Any: any IP address • IP: specific an IP address • IP Group: specific an IP group • SIP Server
Source Prefix	All the caller number must match the source prefix. It specifies the source prefix allow to send call out <ul style="list-style-type: none"> • Any: include anonymous, 0xxxx, 1[2-9]xxxx etc. • 0xxxx: consist of some digits such as 015,08,09 • 1[3-8]6:consist of some prefix, include 136,146,156,166,176, 186
Destination Prefix	All the called number must match the destination prefix, the call prefix indicates the connected number <ul style="list-style-type: none"> • Any: include anonymous, 0xxxx, 1[2-9]xxxx etc. • 0xxxx: consist of some digits such as 015,08,09 • 1[3-8]6:consist of some prefix, include 136,146,156,166,176, 186
Destination	Its specifies destination Port or Port Group
Stripped Digits from Left	It specifies the length of the digits to be deleted from left
Stripped Digits from Right	It specifies the length of the digits to be deleted from right
Prefix to Add	Add the new digits in front of the original number
Suffix to Add	Add the new digits at the end of the original number

Add an IP->Tel Manipulation, to change the called number from 2547888888 to 07888888

Figure 4-8-2 IP->Tel destination numbers manipulation

IP->Tel Destination Numbers Add

Index	<input type="text" value="31"/>
Description	<input type="text" value="Remove 254"/>
Source Prefix	<input type="text" value="any"/>
Source	<input type="radio"/> IP <input type="text" value="31 <Elastix>"/> <input type="radio"/> IP Group <input type="text"/> <input checked="" type="radio"/> SIP Server
Destination Prefix	<input type="text" value="2547"/>
Destination	<input type="radio"/> Port <input type="text" value="0"/> <input checked="" type="radio"/> Port Group <input type="text" value="0 <A>"/>
Stripped Digits from Left	<input type="text" value="3"/>
Stripped Digits from Right	<input type="text"/>
Prefix to Add	<input type="text" value="0"/>
Suffix to Add	<input type="text"/>

It indicates that calls coming from IP Group will match the prefix "any", and the called number which match with the prefix "2547" will delete 3 digits in front of it and replace it by digit "0".

4.8.2 Tel->IP Source Numbers

Figure 4-8-3 Tel->IP destination numbers manipulation

Tel->IP Source Numbers									
Index	Description	Source Prefix	Destination Prefix	Destination	Stripped Digits from Left	Stripped Digits from Right	Prefix to Add	Suffix to Add	Number of Digits to Leave from Right
---	---	---	---	---	---	---	---	---	---

Total: 0entry 16entry/page 1/0page

Table 4-8-2 Description of Tel->IP destination numbers manipulation

Parameters	Description
Tel->IP Source numbers manipulation	It is an optional configuration item, and is used to add IP->Tel number change data. The IP->Tel Manipulation defined the rules of add, and deletion of called numbers, which are referenced by IP->Tel routing.
Index	It uniquely identifies a route. Its value is assigned globally, ranging from 0 to 31.
Description	It describes the rule for the ease of identification. Its value is character string

Source Prefix	<p>All the caller number must match the source prefix. It specifies the source prefix allow to send call out</p> <ul style="list-style-type: none"> • Any: include anonymous, 0xxxx, 1[2-9]xxxx etc. • 0xxxx: consist of some digits such as 015,08,09 • 1[3-8]6:consist of some prefix, include 136,146,156,166,176, 186
Destination Prefix	<p>All the called number must match the destination prefix, the call prefix indicates the connected number</p> <ul style="list-style-type: none"> • Any: include anonymous, 0xxxx, 1[2-9]xxxx etc. • 0xxxx: consist of some digits such as 015,08,09 1[3-8]6:consist of some prefix, include 136,146,156,166,176, 186
Destination	<p>Its specifies destinations:</p> <ul style="list-style-type: none"> • Port • Port Group • IPs • IP Group • SIP Server
Stripped Digits from Left	It specifies the length of the digits to be deleted from left
Stripped Digits from Right	It specifies the length of the digits to be deleted from right
Prefix to Add	Add the new digits in front of the original number
Suffix to Add	Add the new digits at the end of the original number
Number of Digits to Leave from Right	It specifies the number of Digits to Leave from Right

Example

Add aTel->IP Manipulation, to change the caller number to 07888888

Figure 4-8-4 Tel ->IP destination numbers source manipulation add

Tel->IP Source Numbers Add

Index	<input type="text" value="31"/>
Description	<input type="text" value="C07888888"/>
Source Prefix	<input type="text" value="any"/>
Source	<input checked="" type="radio"/> Port <input type="text" value="Any"/>
	<input type="radio"/> Port Group <input type="text" value="0 <A>"/>
Destination Prefix	<input type="text" value="any"/>
Destination	<input type="radio"/> Port <input type="text" value="0"/>
	<input type="radio"/> Port Group <input type="text" value="0 <A>"/>
	<input type="radio"/> IP <input type="text" value="31 <Elastix>"/>
	<input type="radio"/> IP Group <input type="text"/>
	<input checked="" type="radio"/> SIP Server
Stripped Digits from Left	<input type="text" value="24"/>
Stripped Digits from Right	<input type="text"/>
Prefix to Add	<input type="text" value="07888888"/>
Suffix to Add	<input type="text"/>

It indicates that all incoming calls which matched with source & destination prefix "any", to delete original caller number and replace by 07888888.

4.8.3 Tel->IP Destination Numbers

Figure 4-8-5 Tel->IP destination numbers manipulation

Tel->IP Destination Numbers									
Index	Description	Source Prefix	Destination Prefix	Destination	Stripped Digits from Left	Stripped Digits from Right	Prefix to Add	Suffix to Add	Number of Digits to Leave from Right
---	---	---	---	---	---	---	---	---	---

Total: 0entry 16entry/page 1/0page

Table 4-8-3 Description of Tel->IP destination numbers manipulation

Parameters	Description
Tel->IP destination numbers manipulation	It is an optional configuration item which used to add Tel-> IP destination number manipulation rules. The Tel-IP Manipulation defined the rules of add, and deletion of called numbers, which are referenced by Tel->IP routing.
Index	It uniquely identifies a route. Its value is assigned globally, ranging from 0 to 31.

Description	It describes the route for the ease of identification. Its value is character string
Source Prefix	All the caller number must match the source prefix. It specifies the source prefix allow to send call out <ul style="list-style-type: none"> • Any: include anonymous, 0xxxx, 1[2-9]xxxx etc. • 0xxxx: consist of some digits such as 015,08,09 • 1[3-8]6:consist of some prefix, include 136,146,156,166,176, 186
Destination Prefix	All the called number must match the destination prefix, the call prefix indicates the connected number <ul style="list-style-type: none"> • Any: include anonymous, 0xxxx, 1[2-9]xxxx etc. • 0xxxx: consist of some digits such as 015,08,09 • 1[3-8]6:consist of some prefix, include 136,146,156,166,176, 186
Destination	Its specifies destinations: <ul style="list-style-type: none"> • Port • Port Group • IPs • IP Group • SIP Server
Stripped Digits from Left	It specifies the length of the digits to be deleted from left
Stripped Digits from Right	It specifies the length of the digits to be deleted from right
Prefix to Add	Add the new digits in front of the original number
Suffix to Add	Add the new digits at the end of the original number
Number of Digits to Leave from Right	It specifies the number of Digits to Leave from Right

Example

Add a Tel->IP Manipulation rule, to change the called number from 1111 to 0751111

Figure 4-8-6 Tel->IP destination numbers manipulation

Tel->IP Destination Numbers Add

Index: 31
 Description: Add075
 Source Prefix: any
 Source: Port: Any | Port Group: 0 <all>
 Destination Prefix: 1111
 Destination: Port: 0 | Port Group: 0 <all> | IP: Any | IP Group: 31 <IPGroups> | SIP Server
 Stripped Digits from Left:
 Stripped Digits from Right:
 Prefix to Add: 075
 Suffix to Add:
 Number of Digits to Leave from Right:

It indicates that calls incoming call from mobile will match the prefix "any", and the called number which match with the prefix "1111" will be added 075 in front of called number.

4.9 Operation

4.9.1 IP->Tel Operation

Figure 4-9-1 IP->Tel Operation

IP->Tel Operation						
	Index	Source IP	Source Prefix	Destination Prefix	Operation	Description
<input type="checkbox"/>	29	IP 13	any	any	Allow ,Need Pa..	password
<input type="checkbox"/>	30	IP 14	2877	13[58]	Forbid ,	restrict mobile
<input type="checkbox"/>	31	IP 14	2877	07	Forbid ,	restrict unicom

Total: 3entry 16entry/page 1/1page Page 1

Table 4-9-1 Description of IP->Tel Operation

Parameters	Description
IP->Tel Operation	It is an optional configuration item. Operation configuration essentially involves allow, barring some IP and IP Group send calls to certain numbers. It includes: forbid call, call allowance, auto call, and password authentication.
Index	It uniquely identifies a route. Its value is assigned globally, ranging from 0 to 31.

Source IP	<p>It specifies the source IP/SIP server which will send the calls to gateway</p> <ul style="list-style-type: none"> • Any: any IP address • IP: specific an IP address • IP Group: specific an IP group
Source Prefix	<p>All the caller number must match the source prefix. It specifies the source prefix allow to send call out</p> <ul style="list-style-type: none"> • Any: include anonymous, 0xxxx, 1[2-9]xxxx etc. • 0xxxx: consist of some digits such as 015,08,09 • 1[3-8]6:consist of some prefix, include 136,146,156,166,176, 186
Destination Prefix	<p>All the called number must match the destination prefix, the call prefix indicates the connected number</p> <ul style="list-style-type: none"> • Any: include anonymous, 0xxxx, 1[2-9]xxxx etc. • 0xxxx: consist of some digits such as 015,08,09 • 1[3-8]6:consist of some prefix, include 136,146,156,166,176, 186
Operation	<p>Its specifies number analysis rule</p> <ul style="list-style-type: none"> • Forbid call • Allow call • Auto call • Password authenticate
Description	<p>It describes the route for the ease of identification. Its value is character string</p>

► **Example: IP-Tel Operation**

Index 31: barring the certain calling number from IP 14<elastix>

Figure 4-9-2 IP->Tel Operation

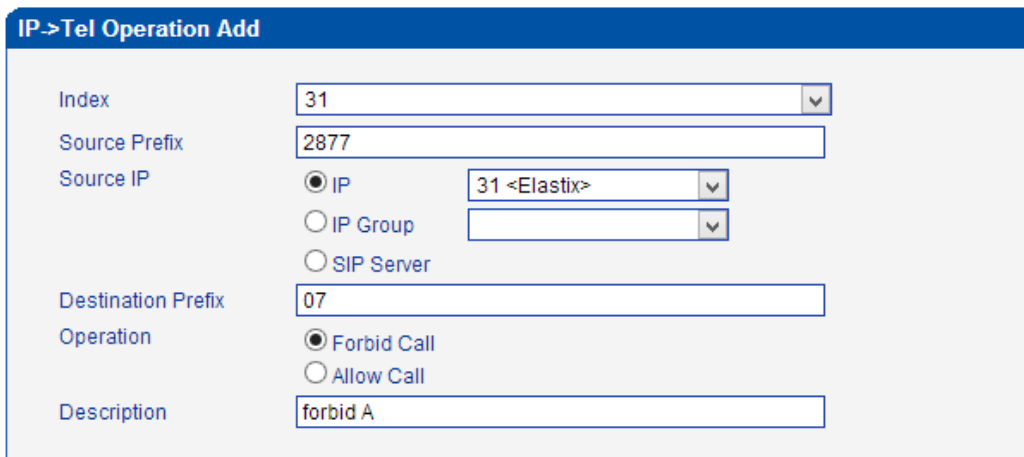

IP->Tel Operation Add

Index: 31

Source Prefix: 2877

Source IP:

- IP: 31 <Elastix>
- IP Group
- SIP Server

Destination Prefix: 07

Operation:

- Forbid Call
- Allow Call

Description: forbid A

It indicates that calling party from IP 14<elastix> matched prefix 2877, and also called party matched prefix 07 are not allowed call out. The calls match this rule will be rejected by gateway.

Index 29: define a rule for IP 17<FreeSentral> that all the calls must go with valid password authentication.

Figure 4-9-3 IP->Tel Operation

4.9.2 Tel->IP Operation

Figure 4-9-4 Tel->IP Operation

Table 4-9-2 Description of Tel->IP Operation

Parameters	Description
Tel->IP Operation	It is an optional configuration item. To enable following features in this menu: <ul style="list-style-type: none"> • Forbid Call • Call Back • Auto Call • Allow Call • Password Authentication
Index	It uniquely identifies a rule. Its value is assigned globally, ranging from 0 to 31.
Source Port	It specifies the source port which come from mobile
Source Prefix	All the caller number must match the source prefix. It specifies the source prefix allow to send call out <ul style="list-style-type: none"> • Any: include anonymous, 0xxxx, 1[2-9]xxxx etc. • 0xxxx: consist of some digits such as 015,08,09 • 1[3-8]6:consist of some prefix, include 136,146,156,166,176, 186

Destination Prefix	<p>All the called number must match the destination prefix, the call prefix indicates the connected number</p> <ul style="list-style-type: none"> Any: include anonymous, 0xxxx, 1[2-9]xxxx etc. 0xxxx: consist of some digits such as 015,08,09 1[3-8]6:consist of some prefix, include 136,146,156,166,176, 186
Operation	<p>Its specifies number analysis rule</p> <ul style="list-style-type: none"> Forbid call Call Back Allow call Auto call Password authenticate
Description	<p>It describes the route for the ease of identification. Its value is character string</p>

► **How to route incoming call to DID or IVR automatically?**

Step1: System Configuration-> Port Configuration to configure VoIP hotline number, this hotline number can be DIDs, access code and extension etc.

Port Configuration

Current Port: Port 0

SIP User ID:

Authenticate ID:

Authenticate Password: Show Password

Tx Gain: +2dB

Rx Gain: +6dB

To VOIP Hotline:

To PSTN Hotline:

Auto-Dial Delay Time: s

Step2: Operation-> Tel->IP Operation to add a new rule:

Tel->IP Operation Add

Index: 31

Source Prefix: any

Source Port: Port Any Port Group 0 <A>

Destination Prefix: any

Operation: Forbid Call Callback Allow Call Auto Call Password Authentication

Description: Hotline

4.10 Port Group Configuration

4.10.1 Port Group

Figure 4-10-1 Port Group

Port Group				
	Index	Description	Port	Select Mode
<input type="checkbox"/>	0	all	0,1,	Cyclic Ascending

Total: 1entry 16entry/page 1/1page Page 1

NOTE: 0 port group is not allowed to delete, only allowed to change.

Figure 4-10-2 Port Group Modify

Port Group Modify

Index:

Description:

Select Mode:

Port:

<input checked="" type="checkbox"/> Port 0	<input checked="" type="checkbox"/> Port 1
<input type="checkbox"/> Port 2	<input type="checkbox"/> Port 3
<input type="checkbox"/> Port 4	<input type="checkbox"/> Port 5
<input type="checkbox"/> Port 6	<input type="checkbox"/> Port 7

4.11 IP Trunk Configuration

4.11.1 IP Trunk

Figure 4-11-1 IP Trunk

IP Trunk					
	Index	IP	Port	Description	KeepAlive Enable
<input type="checkbox"/>	31	172.16.221.221	5060	Elastix	No

Table 4-11-1 Description of IP Trunk

Parameters	Description
IP Trunk	Add remote IP of Softswitch, SIP server which will send call traffics to gateway.
Index	It uniquely identifies a trunk. Its value is assigned globally, ranging from 0 to 31.
Description	It describes the trunk for the ease of identification. Its value is character string

IP	It is an interworking parameter between the remote Softswitch and the SIP server. It specifies the IP address of the peer equipment.
Port	It is an interworking parameter between the remote Softswitch and the SIP server. It specifies the SIP port number of the peer equipment
Keep alive	Send OPTION to Softswitch/IPPBX to detect health status

Example

To add a remote IP of Softswitch, IP trunk index is 31, SIP port number “5060”

Figure 4-11-2 IP Trunk Modify

4.11.2 IP Trunk Group

Figure 4-11-3 IP Trunk Group

Table 4-11-2 Description of IP Trunk Group

Parameters	Description
IP Trunk Group	This configuration is optional, and is used to add the IP that have the same attributes to an IP group. The IP group will referenced by IP->Tel routing and number manipulation.
Index	It uniquely identifies a route. Its value is assigned globally, ranging from 0 to 31.
Description	It describes the route for the ease of identification. Its value is character string
IP	It specifies the IP will add to IP group

Example

To add an IP group, set IP “10, 14, 17” to IP group 18

Figure 4-11-4 IP Trunk group modify

IP Trunk Group Add			
Index	31		
Description	Default		
IP	Index	IP	Port
<input checked="" type="checkbox"/>	31	172.16.221.221	5060

4.12 System Configuration

4.12.1 Service Parameter

Service Configuration is used for configuring voice calls and some small businesses, such as Call Progress Tone, codec, silence suppression, * service, the second dial and so on.

► To configure voice Processing Parameters

Local Start RTP Port	8000
Enable Silence Suppression	<input type="radio"/> No <input checked="" type="radio"/> Yes
Call Progress Tone	USA
Ring Back Tone	440,280,480,280,2000,40
Busy Tone	480,330,620,330,500,500
Dial Tone	350,260,440,260,0,0,0,0
Preferred Coders(in listed order)	
1st	G.729AB
2nd	PCMU
3rd	PCMA
4th	G.723.1
Voice Frames per Tx	2

► Local Start RTP Port

Means the initial port when RTP voice stream transmit in the IP network, in general, using the factory default values. When there are several ID-LINK units are deployed and they are in the same network or behind the same NAT, user can try to change it to avoid NAT traversal issue;

► Enable Silence Suppression

Enable the "silence suppression" almost no impact on call quality, and can save about half of the bandwidth;

► Call Progress Tone

Each country has its different call progress tone required standards, such as busy tone, ring back tones and ring tone standards, users can select the area standard

from here

USA Standard:

Ringback Tone: 440,280,480,280,2000,4000,0,0 frequency: 440/480Hz

on:2000ms off:4000ms

Busy Tone: 480, 330, 620, 330, 500, 500, 0, 0 frequency: 480/620Hz, on: 500ms off: 500ms

▶ **Preferred Coders**

Means the code format when Voice transfer on IP network, support PCMA, PCMU, G.723.1 and G.729AB.

▶ **To configure dialing mode parameters**

Do Not Answer GSM Incoming Call for Hotline	<input type="radio"/> No <input checked="" type="radio"/> Yes
Enable GSM Incoming Configuration	<input type="radio"/> No <input checked="" type="radio"/> Yes
Auto Outgoing Routing Type	Polling ▾
IP to GSM One Stage Dialing	<input type="radio"/> No <input checked="" type="radio"/> Yes
Answer Delay	<input type="text" value="5"/> s
Redirect Call When All Ports Busy	<input checked="" type="radio"/> No <input type="radio"/> Yes
Play Voice Prompt for GSM Incoming Calls	<input type="radio"/> No <input checked="" type="radio"/> Yes
RTP Detected Enable	<input type="radio"/> No <input checked="" type="radio"/> Yes
Period without RTP Packet	<input type="text" value="90"/>

▶ **Do Not Answer GSM Incoming Call for Hotline**

When the gateway get incoming call from mobile network, the module will answer the call then start to DTMF or route to destination hotline number. While this option enabled, the module won't answer the call but routing to destination hotline number till it getting answer.

Notes: Refer to Port Parameter page for Hotline configuration.

▶ **Enable PSTN Incoming Configuration**

Means when call from mobile side, you can dial the featurecodes (**Chapter 3 Basic Operation**) to configure IP address and so on

▶ **Enable Auto Outgoing Routing**

Means when call out, whether by ordinal or polling pick to Select a Channel, this feature are generally used when use the same SIP User ID to register.

▶ **IP to PSTN One Stage Dialing**

The GSM/CDMA gateway support two dialing mode, one stage and two stage dialing. One stage dialing will obtain called number from *INVITE* message body, either *Request line* or *To*<SIP:xxxxx@host.com> field. Then deliver called number to GSM/CDMA directly.

But for two stage dialing, the SIP server must be dial the SIP channel account and then to generate DTMF to mobile network.

▶ **Answer Delay**

In most instances, Most of CDMA operators don't offer answer signal. The gateway doesn't response SIP 200 OK to SIP server in case of missing answer signal from CDMA network. Answer delay is to fix this issue and generate SIP 200 OK to SIP server after answer delay timeout. Default value is 5 seconds. Moreover, it is available for CDMA gateway only.

▶ **Redirect Call when All Port Busy**

When the gateway is running heavy traffic and not possible to call out, the call will redirect to specific destination route as configuration.

IP and Port: destination gateway or IPPBX to be redirect

▶ **Play Voice Prompt for PSTN Incoming Calls**

Default setting is Yes. when the gateway receive incoming from mobile, it will play default/customized voice prompt to caller party. Default voice prompt is "Please dial the extension "; if set to No, the device will play dial tone instead of voice prompt.

▶ **RTP Detect**

This option is to disconnect call when there is no RTP received. Default value is 90s

▶ **Configure DTMF and NAT Traversal**

DTMF Parameter	
DTMF Method	RFC2833
RFC2833 Payload Type	101
DTMF Volume	0dB
DTMF Interval	200 ms
NAT Traversal	
Refresh Interval	0 s
STUN Server IP	
STUN Server Port	3478

▶ **DTMF**

DWG2001/DWG2004/DWG2000B-8G support RFC2833 and SIGNAL two ways.

DTMF INTERVAL range is 50 ~ 800ms, DTMF VOLUME can use the default Configuration

▶ **Nat Traversal**

Include Static NAT, Dynamic NAT and STUN

STUN (Simple Traversal of UDP over NATs) is a network protocol. It is allowed to stay behind the NAT (or multiple NAT) client part to identify their clients' public address, found himself after what Type of NAT and NAT for a particular Channel is bound to a local Internet terminal Channel. This information is used for two host to set up UDP communication behind the same NAT router. The agreement defined by the RFC 3489

▶ **Other configuration**

Other Configuration	
Enable Private Service	<input type="radio"/> No <input checked="" type="radio"/> Yes
User ID Is Phone Number	<input checked="" type="radio"/> No <input type="radio"/> Yes
Only Accept Calls from SIP Server	<input checked="" type="radio"/> No <input type="radio"/> Yes
Allow Call from GSM to IP without Registration	<input type="radio"/> No <input checked="" type="radio"/> Yes
Allow Call from IP to GSM without Registration	<input type="radio"/> No <input checked="" type="radio"/> Yes
Reject Anonymous Call from IP to GSM	<input checked="" type="radio"/> No <input type="radio"/> Yes
Use # as End Key	<input type="radio"/> No <input checked="" type="radio"/> Yes
No Answer Timeout	55 s
Interdigit Timeout	4 s
Call Delay	0 s

▶ **Enable Private Service**

To enable local services like *158# etc.

▶ **User ID Is Phone Number**

Default is No. user=phone will be added in SIP message body when this option enabled.

▶ **Only Accept Calls from SIP Server**

Default is No. All calls will be rejected except calls from SIP server. IP Trunk will not work when this option enabled.

▶ **Allow Call from PSTN to IP without Registration**

Refer to "SIP Configuration" -> "Is register". If "Is register" setting is no, this option

need set Yes, to avoid that the devices can not call in

▶ **Allow call from IP to PSTN without Registration**

Refer to "SIP Configuration" -> "Is register". If "Is register" setting is no, this option need set Yes, to avoid that the devices can not call out

▶ **Reject Anonymous call from IP to PSTN**

The incoming anonymous calls will be rejected

▶ **Use # as End Key**

In General, SIP phones are based on # as the end, if this option is set to No, the dial-up will end expires dial-up time

▶ **Interdigit Timeout**

Bit of between the dialing time, over the time will be seem as end of dia

▶ **Call Delay**

Default value is 0s.

4.12.2 SIP Parameter

This section is describes how to configure SIP server and SIP parameters.

▶ **Configure SIP server and Outbound Proxy server**

SIP Proxy	
SIP Server Address	<input type="text"/>
SIP Server Port(default: 5060)	<input type="text" value="5060"/>
Check Net Status	<input checked="" type="radio"/> No <input type="radio"/> Yes
Outbound Proxy	
Outbound Proxy Address	<input type="text"/>
Outbound Proxy Port	<input type="text" value="5060"/>

▶ **SIP Server Address and Port**

Used for configure SIP server address and port, the address can be IP Address, also can be a domain name which can be resolved by DNS server

▶ **Check NET Status**

Default is No. if it set to Yes, the gateway will send SIP OPTION periodic to check health status between gateway and SIP server.

▶ **Outbound Proxy**

Outbound proxy, it mainly used in firewall / NAT environment. That make the

signaling and media streams are able to penetrate the firewall.

▶ **Local SIP Port Configuration**

In order to work different application scenarios, the gateway provides flexible configuration with local SIP port.

All Ports Register Used Same User ID No Yes
 Use Same Local Sip Port No Yes
 Use Random Port No Yes
 Local SIP Port

▶ **Random**

The gateway will generate SIP port after each reboot by random. It is commonly used while 5060 is blocked or conflict with other devices.

▶ **Use the same SIP port**

It is mostly used to SIP trunk interworking with SIP server so that the gateway is able to deal with high performance concurrent calls.

Use the same local SIP port and SIP User ID

Port	SIP User ID	Authenticate ID	Tx Gain	Rx Gain	To VOIP Hotline	To PSTN Hotline	Auto-Dial Delay Time(s)	Detail
0	1000	1000	2	6	s		3	Detail

▶ **Use the separate SIP port**

Each channel has separate SIP port so that they could be handle SIP call separately.

After *Use Same Local SIP Port* set to *No*

All Ports Register Used Same User ID No Yes
 Use Same Local Sip Port No Yes

The Local SIP port will be changed on *Port Parameter* page.

Port	SIP User ID	Authenticate ID	Local Sip Port	Tx Gain	Rx Gain	To VOIP Hotline	To PSTN Hotline	Auto-Dial Delay Time(s)	Detail
0	1000	1000	5060	2	6	s		3	Detail
1			5062	2	6			0	Detail
2			5064	2	6			0	Detail
3			5066	2	6			0	Detail
4			5068	2	6			0	Detail
5			5070	2	6			0	Detail
6			5072	2	6			0	Detail
7			5074	2	6			0	Detail

► Register Interval and DNS SRV

Is Register	<input type="radio"/> No <input checked="" type="radio"/> Yes
Register Interval(range: 1 - 3600s)	<input type="text" value="1800"/> s
DNS query type	<input type="text" value="A query"/> ▼
DNS refresh interval (range:0 - 60,000min, 0 means disable)	<input type="text" value="0"/> min

► Is Register

Default set yes, if you want the device can make a call without register, set No, Also enable the "Allow Call from IP to PSTN without Registration" and "Allow Call from PSTN to IP without Registration" function

► Register Interval

This field specifies the value that the gateway will send in the Expires header of the REGISTER message. Its value range from 1-3600s. But in fact, the gateway will get 200OK response from SIP server after REGISTER request, and an Expires header will be included in 200 OK message body. This value in the 200OK determines the time, in seconds, after which the registration expires. The gateway will refresh the registration Timer Register Delta seconds before the end of this interval.

► DNS query type

The DNS query type defines the type of information that will be requested from DNS server

► DNS refresh interval

The interval of DNS refresh, Range from 0 to 60000 mins, 0 means disable default value is disable.

► Configuring SIP Timers

T1	<input type="text" value="500"/> ms
T2	<input type="text" value="4000"/> ms
T4	<input type="text" value="5000"/> ms
TMAX	<input type="text" value="32000"/> ms
Keepalive Interval(range:32 - 3600s)	<input type="text" value="32"/> s
Keepalive SIP ID	<input type="text"/>
Keepalive Retry Count(range:1 - 10)	<input type="text" value="3"/>
Enable 100rel	<input checked="" type="radio"/> no <input type="radio"/> yes

- ▶ **T1**
This field specifies the lowest value, in milliseconds, of the retransmission timer for SIP messages. Default specifies 500.
- ▶ **T2**
This field specifies retransmission timer for T1 timeout of SIP message, in milliseconds. Default specifies 4000.
- ▶ **T4**
This field specifies retransmission timer for T2 timeout of SIP message, in milliseconds. Default specifies 5000.
- ▶ **TMAX**
This field specifies maximum timeout value for SIP message. The SIP message will be dropped after TMAX. Default value is 32000
- ▶ **Keepalive Interval**
The gateway can monitor the status of SIP server by sending periodic SIP OPTION messages. This field specifies transmission timer of OPTION message. Its range from 10-3600s.
- ▶ **Keepalive SIP ID**
This field specifies SIP ID of OPTION. The format would be <xxx@host.com >, example:

```

OPTIONS sip:heartbeat@172.16.0.8:2080 SIP/2.0
Via: SIP/2.0/UDP 172.16.222.22;branch=z9hG4bK45c4f8d2026d9eed8a0adcd533161efd;
From: <sip:heartbeat@172.16.222.22:2080>;tag=6d48f0a169d33fe7b032c0fd895084fd
To: <sip:heartbeat@172.16.0.8:2080>
Call-ID: 8874a4e49f11af243c6b717c05a16e35@172.16.222.22
CSeq: 1804289386 OPTIONS
Contact: <sip:31@172.16.222.22>
Max-Forwards: 70
Accept: application/sdp
Content-Length: 0

```
- ▶ **Keepalive Retry Count**
This field specifies re-transmission times for OPTION message. Its value range from 1-10 times.

▶ **Configuring Caller ID and 183 Mode**

From Mode when Caller ID Is Available	Tel/User
From Mode when Caller ID Is Unavailable	Anonymous
Answer Mode	Answered
183 Mode	Immediately
Called Number Parse	Request-Line

► **From Mode when Caller ID Is Available**

Used to configure "From" Mode when Caller ID Is Available when call from GSM to VoIP

Tel/User: *From: Caller ID <sip:3001@host.com>;tag=51088abb*

User/User: *From: 3001 <sip:3001@host.com>;tag=51088abb*

Tel/Tel: *From: Caller ID <sip: Caller ID@host.com>;tag=51088abb*

User/Tel: *From: 3001 <sip: Caller ID @host.com>;tag=51088abb*

► **From Mode when Caller ID Is Unavailable**

Used to configure "From" Mode when Caller ID Is Unavailable

Anonymous : *From: <sip: Anonymous @host.com>;tag=51088abb*

Username : *From: <sip: Username @host.com>;tag=51088abb*

► **Answer Mode**

Answered: Gateway will send SIP message "200 OK" to SIP Server after GSM/CDMA users answered the call.

Alerted: Gateway will send SIP message '200 OK' to SIP Server immediately after 183 Ringing. In this situation, the called party possibly still in ringing status.

► **183 Mode**

Immediately: Gateway will send "183 RING" immediately to SIP Server while it receive "INVITE". In this situation, the called party possibly still not in ringing status.

Alerted: Gateway will send "183 RING" after received exact ringing signal from GSM/CDMA network. In this situation, the called party is definitely in ringing status.

► **Session Timer**

SIP Session Timers which is an extension of SIP RFC 4028 that allows a periodic refreshing of a SIP session using the RE-INVITE/UPDATE message. The refreshing allows both the user agent and proxy to determine if the SIP session is still active. The SIP Session Timer is a keep alive mechanism for SIP sessions that allow User Agents (UA) or proxies to determine the status of a session and to release it if it is not active, even if a BYE has not been received.

Session Timer	<input type="radio"/> No <input checked="" type="radio"/> Yes
Session Timer Interval(range:90 - 60000s)	<input type="text" value="1800"/> s
Session timer mode	<input type="text" value="refresh"/>
Session timer refresher	<input type="text" value="uac"/>

► Session timer Interval

The initial INVITE request establishes the duration of the session and may include a Session-Expires header and a Min-SE header. These headers indicate the session timer value required by the user agent (UAC). A receiving user agent server (UAS) or proxy can lower the session timer value, but not lower than the value of the Min-SE header. If the session timer duration is lower than the configured minimum, the proxy or UAS can also send out a 422 response message. If the UAS or proxy finds that the session timer value is acceptable, it copies the Session-Expires header into the 2xx class response.

A UAS or proxy can insert a Session-Expires header in the INVITE if the UAC did not include one. Thus a UAC can receive a Session-Expires header in a response even if none was present in the request. Its value range from 90-60000s.

► Session Timer Refresher

It specifies refresher which including in SIP message body, user agent client (UAC) or user agent server (UAS).

```
UPDATE sips:bob@192.0.2.4 SIP/2.0
Via: SIP/2.0 pc33.atlanta.example.com;branch=z9hG4bKnashds12
Route: sips:p1.atlanta.example.com;lr
Supported: timer
Session-Expires: 4000;refresher=uac
Max-Forwards: 70
To: Bob <sips:bob@biloxi.example.com>;tag=9as888nd
From: Alice <sips:alice@atlanta.example.com>;tag=1928301774
Call-ID: a84b4c76e66710
CSeq: 314162 UPDATE
Contact: <sips:alice@pc33.atlanta.example.com>
```

► Configuring GSM-SIP Mapping Code

This part specifies response codes between GSM cause reason and SIP response code.

Gsm-Sip Code Map

Gsm Code Enable No Yes

Gsm Reason

- No Port Found
- Unassigned Number
- Normal Call Clearing
- User Busy
- User Not Answer
- Call Rejected
- Mobile Network Fault

Sip Response Code

503
404
480
486
408
403
503

► **SIP Response**

404	Not Found
408	Request Timeout
403	Forbidden
486	Busy Here
480	Temporarily unavailable Resource unavailable
503	Service Unavailable

► **Response Code switch**

This part specifies response codes of SIP between gateway and SIP server. Refer to table *SIP Response*, the SIP server possibly need some specific SIP response from the gateway. Example, SIP server need SIP response *180 Ringing* instead of *183 Ringing*, the configuration should be as below:

Response Code switch

Response code
183

Response code after switch
180

4.12.3 Port Parameter

Figure 4-12-3 Port List

Port	SIP User ID	Authenticate ID	Tx Gain	Rx Gain	To VOIP Hotline	To PSTN Hotline	Auto-Dial Delay Time(s)	Detail
0	2001	2001	2	6	00		3	Detail

Figure 4-12-4 Port Configuration

Port Configuration

All ports register used same user ID No Yes

Current Port Port 0 ▾

SIP User ID

Authenticate ID

Authenticate Password

Tx Gain +2dB ▾

Rx Gain +6dB ▾

To VOIP Hotline

To PSTN Hotline

Table 4-12-3 Description of Port Configuration

Parameters	Description
Port Configuration	Used to configure ports' gain, Auto-Dial, etc.
ALL ports register used same user ID	The default is no. If set to "yes" ,all the ports will use the same user ID to register to SIP server
SIP User ID	It is the account used for registration which provide by SIP server, equipment port's unique identifier
Authenticate ID	The Authentication ID is used for authentication purposes. The SIP user ID is usually the phone number you received from the service provider. Often, the Authentication ID is the same as the user ID
Password	Password of SIP User ID which provide by SIP server
Tx Gain	Tx Gain value of chipset. Adjusting it will effect volume on GSM side.
Rx Gain	Rx Gain value of chipset. Adjusting it will effect volume on IP side.
To VoIP Hotline	When mobile / fixed line users make call to this port, gateway will auto forward to dedicate number. The hotline could be DID / Ring Group / Extension of SIP server / IP-PBX. *Note: Please configure Tel->IP Operation if you need this function.
To PSTN Hotline	When VoIP users make calls to this port, gateway will auto forward to dedicate number. The Hotline number could be mobile / fixed line number. Leave it blank if you don't need this function. *Note: Please configure IP->Tel Operation if you need this function.
Auto-Dial Delay Time	The auto-dial delay time of hotline , the range is 0-10 seconds

4.13 Digit Map

Figure 4-13-1 Digit map

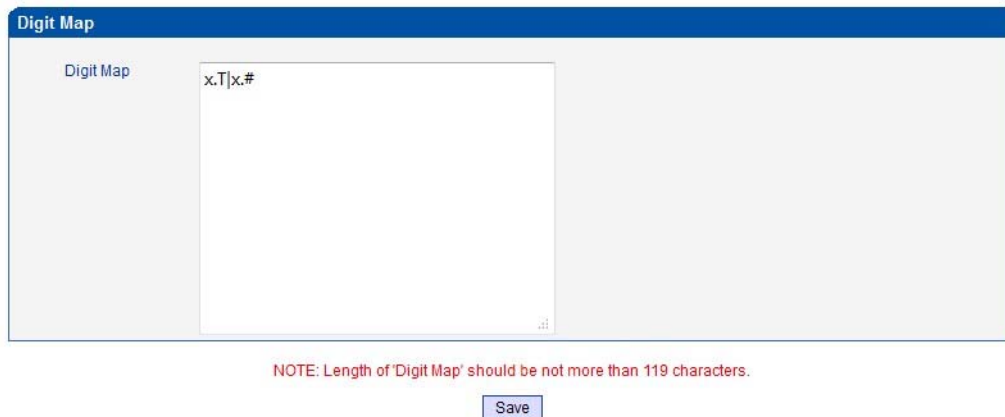

Digit Map

Digit Map x.T|x.#

NOTE: Length of 'Digit Map' should be not more than 119 characters.

Save

Digit Map Syntax:

1. Supported objects

Digit: A digit from "0" to "9".

Timer: The symbol "T" matching a timer expiry.

DTMF: A digit, a timer, or one of the symbols "A", "B", "C", "D", "#", or "*".

2. Range []

One or more DTMF symbols enclosed between square brackets ("[" and "]"), but only one can be selected.

3. Range ()

One or more expressions enclosed between round brackets ("(" and ")"), but only one can be selected.

4. Separator

|: Separated expressions or DTMF symbols.

5. Subrange

-: Two digits separated by hyphen ("-") which matches any digit between and including the two. The subrange construct can only be used inside a range construct, i.e., between "[" and "]".

6. Wildcard

x: matches any digit ("0" to "9").

7. Modifiers

.: Match 0 or more times.

8. Modifiers

+: Match 1 or more times.

9. Modifiers

?: Match 0 or 1 times.

Example:

Assume we have the following digit maps:

1. xxxxxxx | x11

and a current dial string of "41". Given the input "1" the current dial

string becomes "411". We have a partial match with "xxxxxx", but a complete match with "x11", and hence we send "411" to the Call Agent.

2. [2-8] xxxxxx | 13xxxxxxxxx

Means that first is "2","3","4","5","6","7" or "8", followed by 6 digits;
or first is 13, followed by 9 digits.

3. (13 | 15 | 18)xxxxxxxx

Means that first is "13","15" or "18", followed by 8 digits.

4. [1-357-9]xx

Means that first is "1","2","3" or "5" or "7","8","9", followed by 2 digits.

4.14 Tools

4.14.1 Firmware Upload

Firmware upload steps:

Step 1.

Check current running version on gateway, to get firmware version on web page **System Information**

Version Information	Device Model	DWG2000E
	Package Version	02230804 2013-05-29 18:51:05 beta
	Software Version	02230804 2013-05-29 18:50:18
	Web Version	02230804
	Hardware Version	PCB 2
	Logic Version	LOGIC 0
	DSP Version	Branch3.0.0.0
	Userboard 0 Version	B5.1.0.0L51

Step 2.

Prepare firmware package. The most important is that the package must be match with existing version. Package version consist of several parts, as below:

01/02-22/23-xx-xx

01/02 is vendor name

22/23 is hardware version, 02.22.xx.xx and 02.23.xx.xx means they had different hardware version

xx-xx is version number

Step 3.

Upload firmware, select the package from specific folder on the computer and click **Upload** button.

Firmware Upload

Send package file from your computer to the device.

Software 02230801.tar.gz

Step 4.

Keep waiting until it prompt 'Software loaded successfully!'

Prompt

Software loaded successfully!

Step 5.

Reboot gateway. Refer to web page **Tools-> Restart**

Restart

Click this button to restart the device.

4.14.2 Syslog

Syslog is a standard for network device data logging. It allows separation of the software that generates messages from the system that stores them and the software that reports and analyzes them. It also provides devices which would otherwise be unable to communicate a means to notify administrators of problems or performance. There are 5 levels of syslog, including NONE, DEBUG, NOTICE, WARNING and ERROR.

Syslog

Local Syslog	<input checked="" type="checkbox"/> Enable
Server Address	<input type="text"/>
Server Port	<input type="text"/>
Syslog Level	DEBUG <input type="button" value="v"/>
Signal Log	<input type="checkbox"/> Enable
Media Log	<input type="checkbox"/> Enable
System Log	<input type="checkbox"/> Enable
Management Log	<input type="checkbox"/> Enable
Server Syslog	<input type="checkbox"/> Enable

The Signal Log is include following traces which defined in system by default

- SD, hardware debug
- SIP, SIP signaling trace
- STUN, STUN logs

- *ECC, detail information of call control module*
- *RE, the common communication module for SCP and SIM*
- *SCP, the communication protocol between gateway and cloud server*

The media log is include following traces which defined in system by default

- *RTP, RTP stream info collection*
- *SIM, tooutput traces between gateway and remote SIM cards*

The System Log is include following traces which mainly used by developer

- *SYS, system log*
- *TIMER, system process*
- *TASK, system task process*
- *CFM, system process*
- *NTP*

The Management Log is include following traces which defined in system by default

- *CLI, command line*
- *TEL,*
- *LOAD, firmware upload*
- *SNMP*
- *WEBS, embedded web server*
- *PROV, provisioning*

Server Syslog:

When the gateway register to SIM Cloud server, the option will be changed to unconfigurable and all logs to be storage on server.

4.14.3 Filelog /Filelog Download

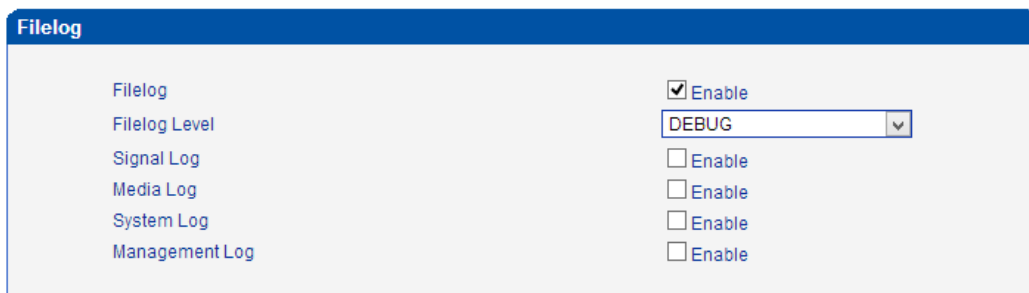

Log Type	Enable
Filelog	<input checked="" type="checkbox"/> Enable
Filelog Level	DEBUG
Signal Log	<input type="checkbox"/> Enable
Media Log	<input type="checkbox"/> Enable
System Log	<input type="checkbox"/> Enable
Management Log	<input type="checkbox"/> Enable

The main difference between Filelog and syslog is, Filelog stores in local internal memory but syslog output external server. The log contents are the same as syslog.

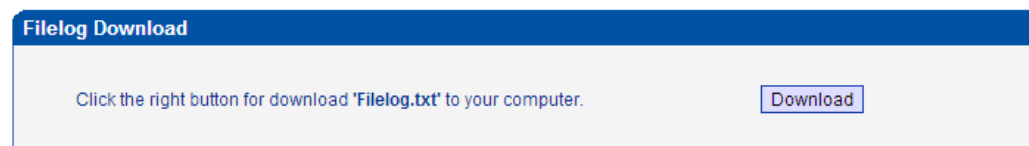

Click the right button for download 'Filelog.txt' to your computer. [Download](#)

4.14.4 Management Parameter

Figure 4-14-2 Management Parameter

Management Parameter

NTP Parameter

NTP Enable Yes No

Primary NTP Server Address

Primary NTP Server Port

Secondary NTP Server Address

Secondary NTP Server Port

Check Interval s

Time Zone

WEB Parameter

WEB Port

Telnet Parameter

Telnet Port

Table 4-14-1 Management Parameter

Parameters	Description
NTP Parameter	The Network Time Protocol (NTP) is a protocol and software implementation for synchronizing the clocks of computer systems over packet-switched, variable-latency data networks. User need to fill the NTP Server Address and select Time Zone
Web Port	Default is 80
Telnet Port	Default is 23

4.14.5 Config Backup

Figure 4-14-3 Data backup

Data Backup

Click 'Backup' for download **configuration** file to your computer.

Click 'Backup' to download configuration file to your computer.

4.14.6 Config Restore

Figure 4-14-4 Config Restore

NOTES: The upload process will last about 30s.

You can restore this configuration in case the unit loses it for any reason or to clone a unit with the configuration of another unit. The configuration backup configurations are in txt format. Please note that you can use a backup file from an older firmware version and use it in a unit with a more recent firmware version. However, a backup file from a newer firmware version than the one actually in the unit cannot be used for a restore operation on the unit.

4.14.7 IVR Voice Prompt Upload

By default, when PSTN call incoming, the system will play the default IVR, and also the user can load custom IVR.

Figure 4-14-5 IVR Voice Prompt Upload

NOTE: 1. Please upload sampled by 8khz, 16bit, and not more than 360k bytes, single channel wav file
2. It must restart the device to take effect.

NOTE: the customize voice files can be recorded using Windows recording programs, the sound format is 8000Hz, 16 bit sampling in mono, with WAV format, size of files cannot be exceed 190KB

4.14.8 Ping Test

Ping is utility used to test the reach ability of a host on an Internet Protocol (IP) network and to measure the round-trip time for messages sent from the originating host to a destination host.

Figure 4-14-6 Ping Test

Ping Test

Ping Destination	<input style="width: 100%;" type="text" value="172.16.1.1"/>
Number of Ping(1-100)	<input style="width: 100%;" type="text" value="4"/>
Ping Packet Size(56-1024 bytes)	<input style="width: 100%;" type="text" value="56"/>

Information

```

Pinging 172.16.1.1 with 56 bytes of data:
Reply seq=0 from 172.16.1.1: bytes=56 time=20ms TTL=64
Reply seq=1 from 172.16.1.1: bytes=56 time<1ms TTL=64
Reply seq=2 from 172.16.1.1: bytes=56 time=10ms TTL=64
Reply seq=3 from 172.16.1.1: bytes=56 time=10ms TTL=64

Ping statistics for 172.16.1.1
Packets: Sent = 4, Received = 4, Lost = 0 (0% loss)
RTT Minimum = 1ms, Maximum = 10ms, Average = 10ms

```

4.14.9 Tracert Test

Tracert is a computer network diagnostic tool for displaying the route (path) and measuring transit delays of packets across an Internet Protocol (IP) network.

Figure 4-14-7 Tracert Test

Tracert Test

Tracert Destination	<input style="width: 100%;" type="text" value="www.google.com.hk"/>
Max Hops of Tracert(1-255)	<input style="width: 100%;" type="text" value="30"/>

Information

```

Tracing route to www.google.com.hk[74.125.71.99] over a maximum of 30 hops:
 0  1 ms  172.16.1.1
 1  *    Request timed out.
 2  *    Request timed out.
 3  30 ms 121.15.179.86
 4  30 ms 119.145.47.46
 5  30 ms 202.97.35.250
 6  40 ms 202.97.60.142
 7  40 ms 202.97.60.22
 8  40 ms 202.97.61.102
 9  80 ms 202.97.62.214
10  40 ms 209.85.241.58
11  30 ms 209.85.253.69
12  40 ms 216.239.48.230
13  30 ms 74.125.71.99
Trace complete.

```

4.14.10 Network Capture

Network capture is a very important diagnostic tool for maintenance. This section describes

how to enable network capture.

Voice stream transmit path of the gateway as below:



► **Getting start to PCM capture**

PCM capture is help to analysis voice stream between GSM/CDMA module and DSP chipset.

► **To enable PCM capture**

- ◆ Select 'PCM only' on Network Capture page

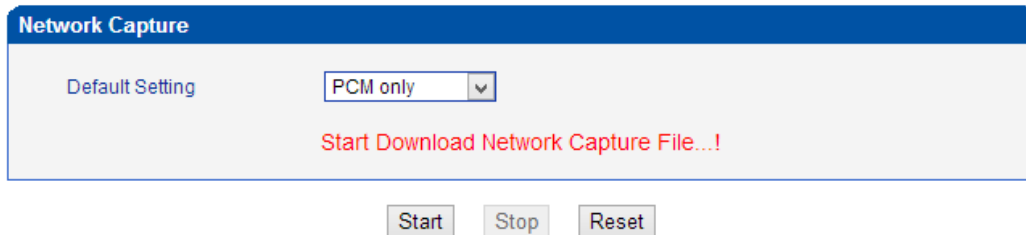

- ◆ Click "Start" to enable PCM capture
- ◆ Dialing out through gateway, start talking a short while then hangup the call.
- ◆ Click 'Stop' to disable network capture
- ◆ Save the capture file to local computer

The capture is named to 'capture(x).pcap', x is serial number of capture and will be added 1 in next time. The sample of PCM capture as below:

No.	Time	Source	Destination	Protocol	Length	Info
1	0.000000	Motorola_1c:1d:1e	Cimsys_33:44:55	CSM_ENCABS	104	--> 0xd021 ch: 0xffff, Seq: 8 (From Host)
2	0.000131	Cimsys_33:44:55	Motorola_1c:1d:1e	ETHERNET	20	ETHERNET II[Malformed Packet] ch: 0xffff, Seq: 11 (From Host)
3	0.000245	Cimsys_33:44:55	Motorola_1c:1d:1e	CSM_ENCABS	44	--> 0xd021 ch: 0x0003, Seq: 0 (From Host)
4	1.320893	Motorola_1c:1d:1e	Cimsys_33:44:55	CSM_ENCABS	104	--> 0xe000 ch: 0x0003, Seq: 1 (From Host)
5	1.321022	Cimsys_33:44:55	Motorola_1c:1d:1e	ETHERNET	20	ETHERNET II[Malformed Packet] ch: 0x0003, Seq: 1 (From Host)
6	1.321139	Cimsys_33:44:55	Motorola_1c:1d:1e	CSM_ENCABS	30	--> 0xe000 ch: 0x0003, Seq: 2 (From Host)
7	1.320890	Motorola_1c:1d:1e	Cimsys_33:44:55	CSM_ENCABS	104	--> 0xd001 ch: 0x0003, Seq: 3 (From Host)
8	1.330010	Cimsys_33:44:55	Motorola_1c:1d:1e	ETHERNET	20	ETHERNET II[Malformed Packet] ch: 0x0003, Seq: 4 (From Host)
9	1.330093	Cimsys_33:44:55	Motorola_1c:1d:1e	CSM_ENCABS	30	--> 0xe001 ch: 0x0003, Seq: 5 (From Host)
10	1.330472	Motorola_1c:1d:1e	Cimsys_33:44:55	CSM_ENCABS	104	--> 0xd002 ch: 0x0003, Seq: 6 (From Host)
11	1.330566	Cimsys_33:44:55	Motorola_1c:1d:1e	ETHERNET	20	ETHERNET II[Malformed Packet] ch: 0x0003, Seq: 7 (From Host)
12	1.330639	Cimsys_33:44:55	Motorola_1c:1d:1e	CSM_ENCABS	30	--> 0xd002 ch: 0x0003, Seq: 8 (From Host)
13	1.330820	Motorola_1c:1d:1e	Cimsys_33:44:55	CSM_ENCABS	104	--> 0xd003 ch: 0x0003, Seq: 9 (From Host)
14	1.330903	Cimsys_33:44:55	Motorola_1c:1d:1e	ETHERNET	20	ETHERNET II[Malformed Packet] ch: 0x0003, Seq: 10 (From Host)
15	1.330989	Cimsys_33:44:55	Motorola_1c:1d:1e	CSM_ENCABS	30	--> 0xd003 ch: 0x0003, Seq: 11 (From Host)
16	1.337791	Motorola_1c:1d:1e	Cimsys_33:44:55	CSM_ENCABS	104	--> 0xd010 ch: 0x0003, Seq: 12 (From Host)
17	1.337996	Cimsys_33:44:55	Motorola_1c:1d:1e	ETHERNET	20	ETHERNET II[Malformed Packet] ch: 0x0003, Seq: 13 (From Host)
18	1.338033	Cimsys_33:44:55	Motorola_1c:1d:1e	CSM_ENCABS	30	--> 0x9010 ch: 0x0003, Seq: 14 (From Host)
19	1.338369	Motorola_1c:1d:1e	Cimsys_33:44:55	CSM_ENCABS	104	--> 0x9000 ch: 0x0003, Seq: 15 (From Host)
20	1.338460	Cimsys_33:44:55	Motorola_1c:1d:1e	ETHERNET	20	ETHERNET II[Malformed Packet] ch: 0x0003, Seq: 16 (From Host)
21	1.338564	Cimsys_33:44:55	Motorola_1c:1d:1e	CSM_ENCABS	30	--> 0x9000 ch: 0x0003, Seq: 17 (From Host)
22	1.343521	Motorola_1c:1d:1e	Cimsys_33:44:55	CSM_ENCABS	104	--> 0xb004 ch: 0x0003, Seq: 18 (From Host)
23	1.343627	Cimsys_33:44:55	Motorola_1c:1d:1e	ETHERNET	20	ETHERNET II[Malformed Packet] ch: 0x0003, Seq: 19 (From Host)
24	1.343725	Cimsys_33:44:55	Motorola_1c:1d:1e	CSM_ENCABS	30	--> 0xb004 ch: 0x0003, Seq: 20 (From Host)
25	1.344060	Motorola_1c:1d:1e	Cimsys_33:44:55	CSM_ENCABS	104	--> 0xb001 ch: 0x0003, Seq: 21 (From Host)

► **Getting start to Syslog capture**

Syslog capture is another way to obtain syslog which the same as remote syslog server and filelog. The capture file is save as pcap format so that it can be opened in some of capture software like Wireshark, Ethereal software etc.

► **To enable syslog capture**

- ◆ Select Syslog special only on Network Capture page

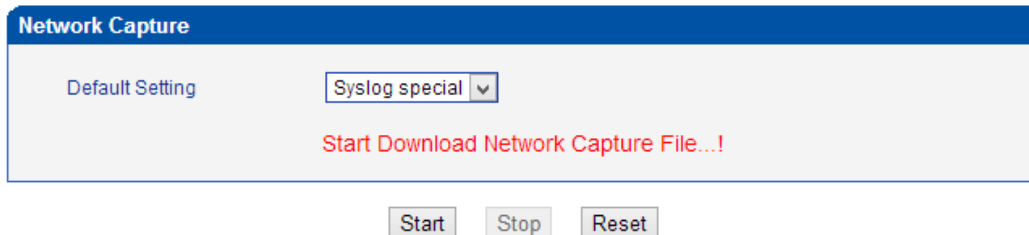

- ◆ Click "Start" to enable syslog capture
- ◆ Dialing out through gateway, start talking a short while then hangup the call.
- ◆ Click 'Stop' to disable syslog capture
- ◆ Save the capture to local computer

The capture is named to 'capture(x).pcap', x is serial number of capture and will be added 1 in next time. The sample of syslog capture as below:

No.	Time	Source	Destination	Protocol	Length	Info
1	0.000000	172.16.222.22	1.1.1.1	Syslog	172	USER.DEBUG: Jul 23 06:52:05 172.16.222.22 mpe_sip: < 0> [DEBUG] ----> to 172.16.222.22/5060 crypt:FALSE #Phone
2	0.000344	172.16.222.22	1.1.1.1	Syslog	320	USER.DEBUG: Jul 23 06:52:05 172.16.222.22 mpe_sip: < 1> [DEBUG] OPTIONS sip:heartbeat@172.16.222.22 SIP/2.0\r\n
3	0.013432	172.16.222.22	1.1.1.1	Syslog	595	USER.DEBUG: Jul 23 06:52:05 172.16.222.22 mpe_sip: < 2> [DEBUG] <----- message from 172.16.222.22/5060, crypt
4	0.013750	172.16.222.22	1.1.1.1	Syslog	176	USER.DEBUG: Jul 23 06:52:05 172.16.222.22 mpe_sip: < 3> [DEBUG] <----- from 172.16.222.22/5060, crypt:FALSE, Phc
5	0.014036	172.16.222.22	1.1.1.1	Syslog	520	USER.DEBUG: Jul 23 06:52:05 172.16.222.22 mpe_sip: < 4> [DEBUG] OPTIONS sip:heartbeat@172.16.222.22 SIP/2.0\r\n
6	0.014512	172.16.222.22	1.1.1.1	Syslog	172	USER.DEBUG: Jul 23 06:52:05 172.16.222.22 mpe_sip: < 5> [DEBUG] ----> to 172.16.222.22/5060 crypt:FALSE #Phone
7	0.014806	172.16.222.22	1.1.1.1	Syslog	587	USER.DEBUG: Jul 23 06:52:05 172.16.222.22 mpe_sip: < 6> [DEBUG] SIP/2.0 200 OK\r\n/via: SIP/2.0/UDP 172.16.222.
8	0.028396	172.16.222.22	1.1.1.1	Syslog	662	USER.DEBUG: Jul 23 06:52:05 172.16.222.22 mpe_sip: < 7> [DEBUG] <----- message from 172.16.222.22/5060, crypt
9	0.028759	172.16.222.22	1.1.1.1	Syslog	176	USER.DEBUG: Jul 23 06:52:05 172.16.222.22 mpe_sip: < 8> [DEBUG] <----- from 172.16.222.22/5060, crypt:FALSE, Phc
10	0.029052	172.16.222.22	1.1.1.1	Syslog	587	USER.DEBUG: Jul 23 06:52:05 172.16.222.22 mpe_sip: < 9> [DEBUG] SIP/2.0 200 OK\r\n/via: SIP/2.0/UDP 172.16.222.
11	0.030017	172.16.222.22	1.1.1.1	Syslog	233	USER.DEBUG: Jul 23 06:52:05 172.16.222.22 mpe_sip: < 10> [DEBUG] sip->app: msgtype:ST_SIP_SERVER_CONN_V\r\n cal
12	0.331167	172.16.222.22	1.1.1.1	Syslog	983	USER.DEBUG: Jul 23 06:52:05 172.16.222.22 mpe_sip: < 11> [DEBUG] <----- message from 172.16.222.22/5060, cryp
13	0.331498	172.16.222.22	1.1.1.1	Syslog	177	USER.DEBUG: Jul 23 06:52:05 172.16.222.22 mpe_sip: < 12> [DEBUG] <----- from 172.16.222.22/5060, crypt:FALSE, PF
14	0.331959	172.16.222.22	1.1.1.1	Syslog	907	USER.DEBUG: Jul 23 06:52:05 172.16.222.22 mpe_sip: < 13> [DEBUG] INVITE sip:10086@172.16.222.22:5060 SIP/2.0\r\n
15	0.332307	172.16.222.22	1.1.1.1	Syslog	122	USER.DEBUG: Jul 23 06:52:05 172.16.222.22 mpe_ecc: < 14> [DEBUG] get route entry 31\r\n
16	0.332584	172.16.222.22	1.1.1.1	Syslog	111	USER.DEBUG: Jul 23 06:52:05 172.16.222.22 mpe_ecc: < 15> [DEBUG] lport:31\r\n
17	0.332848	172.16.222.22	1.1.1.1	Syslog	124	USER.DEBUG: Jul 23 06:52:05 172.16.222.22 mpe_ecc: < 16> [DEBUG] get route, to port:31\r\n
18	0.333315	172.16.222.22	1.1.1.1	Syslog	526	USER.DEBUG: Jul 23 06:52:05 172.16.222.22 mpe_sip: < 17> [DEBUG] sip->app: localIndex:69, msgtype:SIP_CALL_INV
19	0.333603	172.16.222.22	1.1.1.1	Syslog	173	USER.DEBUG: Jul 23 06:52:05 172.16.222.22 mpe_sip: < 18> [DEBUG] ----> to 172.16.222.22/5060 crypt:FALSE #Phone
20	0.333877	172.16.222.22	1.1.1.1	Syslog	386	USER.DEBUG: Jul 23 06:52:05 172.16.222.22 mpe_sip: < 19> [DEBUG] SIP/2.0 100 Trying\r\n/via: SIP/2.0/UDP 172.16.
21	0.346687	172.16.222.22	1.1.1.1	Syslog	131	USER.DEBUG: Jul 23 06:52:05 172.16.222.22 mpe_ecc: < 20> [DEBUG] RTP: alg:0, pkt:20, band:-1\r\n
22	0.347453	172.16.222.22	1.1.1.1	Syslog	120	USER.DEBUG: Jul 23 06:52:05 172.16.222.22 mpe_ecc: < 21> [DEBUG] dial tick:102433\r\n
23	7.232839	172.16.222.22	1.1.1.1	Syslog	533	USER.DEBUG: Jul 23 06:52:12 172.16.222.22 mpe_sip: < 22> [DEBUG] <----- message from 172.16.222.22/5060, cryp
24	7.233513	172.16.222.22	1.1.1.1	Syslog	177	USER.DEBUG: Jul 23 06:52:12 172.16.222.22 mpe_sip: < 23> [DEBUG] <----- from 172.16.222.22/5060, crypt:FALSE, PF
25	7.233959	172.16.222.22	1.1.1.1	Syslog	457	USER.DEBUG: Jul 23 06:52:12 172.16.222.22 mpe_sip: < 24> [DEBUG] CANCEL sip:10086@172.16.222.22:5060 SIP/2.0\r\n
26	7.234596	172.16.222.22	1.1.1.1	Syslog	287	USER.DEBUG: Jul 23 06:52:12 172.16.222.22 mpe_sip: < 25> [DEBUG] sip->app: localIndex:69, msgtype:SIP_CALL_BYE

► **Getting start to RTP capture**

PCM capture is help to analysis voice stream between gateway and remote IPPBX/SIP Server.

► **To enable RTP capture:**

- ◆ Select RTP special on Network Capture page

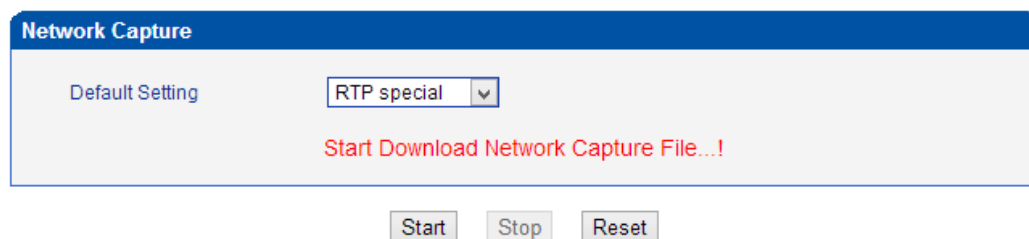

- ◆ Click Start to enable RTP capture

- ◆ Dialing out through gateway, start talking a short while then hangup the call.
- ◆ Click Stop to disable RTP capture
- ◆ Save the capture to local computer

The capture is named to 'capture(x).pcap', x is serial number of capture and will be added 1 in next time. The sample of RTP capture as below:

No.	Time	Source	Destination	Protocol	Length	Info
176	7.020000	172.16.221.228	116.204.105.50	SIP	365	Request: REGISTER sip:116.204.105.50
178	7.030000	116.204.105.50	172.16.221.228	SIP	411	Status: 200 OK (1 bindings)
244	11.610000	172.16.221.228	58.56.64.101	SIP/SDP	814	Request: INVITE sip:201@58.56.64.101
248	11.710000	58.56.64.101	172.16.221.228	SIP	480	Status: 100 Trying
249	11.710000	58.56.64.101	172.16.221.228	SIP/SDP	733	Status: 183 Session Progress
250	11.710000	58.56.64.101	172.16.221.228	SIP/SDP	719	Status: 200 OK
252	11.720000	172.16.221.228	58.56.64.101	RTP	66	unknown RTP version 1
253	11.720000	172.16.221.228	58.56.64.101	RTP	66	unknown RTP version 1
254	11.720000	58.56.64.101	172.16.221.228	RTP	74	PT=ITU-T G.729, SSRC=0x497e6015, Seq=1000, Time=160, Mark
255	11.730000	172.16.221.228	58.56.64.101	RTP	66	unknown RTP version 1
256	11.730000	172.16.221.228	58.56.64.101	RTP	66	unknown RTP version 1
257	11.730000	172.16.221.228	58.56.64.101	RTP	66	unknown RTP version 1
258	11.740000	172.16.221.228	58.56.64.101	SIP	434	Request: ACK sip:201@58.56.64.101:5060
259	11.740000	58.56.64.101	172.16.221.228	RTP	74	PT=ITU-T G.729, SSRC=0x497e6015, Seq=1001, Time=320
261	11.770000	58.56.64.101	172.16.221.228	RTP	74	PT=ITU-T G.729, SSRC=0x497e6015, Seq=1002, Time=480
263	11.780000	58.56.64.101	172.16.221.228	RTP	74	PT=ITU-T G.729, SSRC=0x497e6015, Seq=1003, Time=640
264	11.810000	58.56.64.101	172.16.221.228	RTP	74	PT=ITU-T G.729, SSRC=0x497e6015, Seq=1004, Time=800
265	11.830000	58.56.64.101	172.16.221.228	RTP	74	PT=ITU-T G.729, SSRC=0x497e6015, Seq=1005, Time=960
266	11.840000	58.56.64.101	172.16.221.228	RTP	74	PT=ITU-T G.729, SSRC=0x497e6015, Seq=1006, Time=1120
267	11.870000	58.56.64.101	172.16.221.228	RTP	74	PT=ITU-T G.729, SSRC=0x497e6015, Seq=1007, Time=1280
268	11.890000	58.56.64.101	172.16.221.228	RTP	74	PT=ITU-T G.729, SSRC=0x497e6015, Seq=1008, Time=1440
270	11.900000	58.56.64.101	172.16.221.228	RTP	74	PT=ITU-T G.729, SSRC=0x497e6015, Seq=1009, Time=1600
271	11.930000	172.16.221.228	58.56.64.101	RTP	74	PT=ITU-T G.729, SSRC=0x43455AA6, Seq=31521, Time=1806312883
273	11.930000	58.56.64.101	172.16.221.228	RTP	74	PT=ITU-T G.729, SSRC=0x497e6015, Seq=1010, Time=1760
274	11.940000	58.56.64.101	172.16.221.228	RTP	74	PT=ITU-T G.729, SSRC=0x497e6015, Seq=1011, Time=1920
275	11.950000	172.16.221.228	58.56.64.101	RTP	74	PT=ITU-T G.729, SSRC=0x43455AA6, Seq=31522, Time=1806313043
277	11.970000	58.56.64.101	172.16.221.228	RTP	74	PT=ITU-T G.729, SSRC=0x497e6015, Seq=1012, Time=2080
278	11.970000	172.16.221.228	58.56.64.101	RTP	74	PT=ITU-T G.729, SSRC=0x43455AA6, Seq=31523, Time=1806313203

► **Getting start to DSP capture**

DSP capture is help to analysis voice stream inside DSP chipset. The DSP chipset will handle RTP from IP network as well as voice stream from GSM/CDMA module.

► **To enable DSP capture:**

- ◆ Select DSP only on Network Capture page

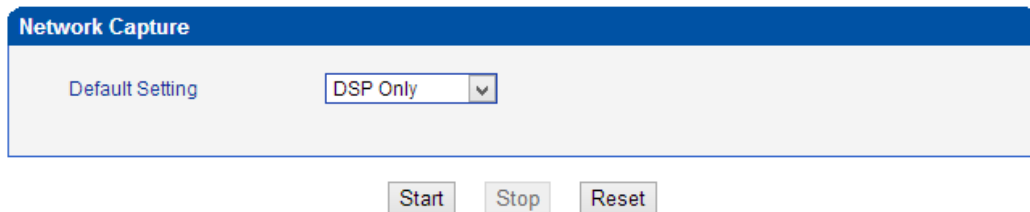

- ◆ Click Start to enable DSP capture
- ◆ Dialing out through gateway, start talking a short while then hangup the call.
- ◆ Click Stop to disable DSP capture
- ◆ Save the capture to local computer

The capture is named to 'capture(x).pcap', x is serial number of capture and will be added 1 in next time. The sample of RTP capture as below:

No.	Time	Source	Destination	Protocol	Length	Info	
1	0.000000	Motorola_1c:1d:1e	Cimsys_33:44:55	CSM_ENCAPS	104	--> 0x0021	Ch: 0xFFFF, Seq: 2 (From Host)
2	0.007246	Cimsys_33:44:55	Motorola_1c:1d:1e	ethernet	20	ethernet II[Malformed Packet]	Ch: 0xFFFF, Seq: 5 (From Host)
3	0.007260	Cimsys_33:44:55	Motorola_1c:1d:1e	CSM_ENCAPS	44	--> 0x0021	Ch: 0xFFFF, Seq: 3 (From Host)
4	2.994581	Motorola_1c:1d:1e	Cimsys_33:44:55	CSM_ENCAPS	104	--> 0x0021	Ch: 0xFFFF, Seq: 4 (From Host)
5	2.997308	Cimsys_33:44:55	Motorola_1c:1d:1e	ethernet	20	ethernet II[Malformed Packet]	Ch: 0xFFFF, Seq: 6 (From Host)
6	2.997316	Cimsys_33:44:55	Motorola_1c:1d:1e	CSM_ENCAPS	44	--> 0x0021	Ch: 0xFFFF, Seq: 4 (From Host)
7	5.992790	Motorola_1c:1d:1e	Cimsys_33:44:55	CSM_ENCAPS	104	--> 0x0021	Ch: 0xFFFF, Seq: 3 (From Host)
8	5.997282	Cimsys_33:44:55	Motorola_1c:1d:1e	ethernet	20	ethernet II[Malformed Packet]	Ch: 0xFFFF, Seq: 7 (From Host)
9	5.997290	Cimsys_33:44:55	Motorola_1c:1d:1e	CSM_ENCAPS	44	--> 0x0021	Ch: 0xFFFF, Seq: 3 (From Host)
10	7.691428	Motorola_1c:1d:1e	Cimsys_33:44:55	CSM_ENCAPS	104	--> 0x9010	Ch: 0x0003, Seq: 3 (From Host)
11	7.691552	Cimsys_33:44:55	Motorola_1c:1d:1e	ethernet	20	ethernet II[Malformed Packet]	Ch: 0x0003, Seq: 1 (To Host)
12	7.691715	Cimsys_33:44:55	Motorola_1c:1d:1e	CSM_ENCAPS	30	--> 0x9010	Ch: 0x0003, Seq: 4 (From Host)
13	7.701379	Motorola_1c:1d:1e	Cimsys_33:44:55	CSM_ENCAPS	104	--> 0x9000	Ch: 0x0003, Seq: 4 (From Host)
14	7.701494	Cimsys_33:44:55	Motorola_1c:1d:1e	ethernet	20	ethernet II[Malformed Packet]	Ch: 0x0003, Seq: 2 (To Host)
15	7.701622	Cimsys_33:44:55	Motorola_1c:1d:1e	CSM_ENCAPS	30	--> 0x9000	Ch: 0x0003, Seq: 5 (From Host)
16	7.709662	Motorola_1c:1d:1e	Cimsys_33:44:55	CSM_ENCAPS	104	--> 0x8084	Ch: 0x0003, Seq: 3 (To Host)
17	7.709798	Cimsys_33:44:55	Motorola_1c:1d:1e	ethernet	20	ethernet II[Malformed Packet]	Ch: 0x0003, Seq: 6 (From Host)
18	7.709902	Cimsys_33:44:55	Motorola_1c:1d:1e	CSM_ENCAPS	30	--> 0x8084	Ch: 0x0003, Seq: 3 (To Host)
19	7.710238	Motorola_1c:1d:1e	Cimsys_33:44:55	CSM_ENCAPS	104	--> 0x8001	Ch: 0x0003, Seq: 6 (From Host)
20	7.710328	Cimsys_33:44:55	Motorola_1c:1d:1e	ethernet	20	ethernet II[Malformed Packet]	Ch: 0x0003, Seq: 4 (To Host)
21	7.710496	Cimsys_33:44:55	Motorola_1c:1d:1e	CSM_ENCAPS	30	--> 0x8001	Ch: 0x0003, Seq: 7 (From Host)
22	7.716241	Motorola_1c:1d:1e	Cimsys_33:44:55	CSM_ENCAPS	104	--> 0x8018	Ch: 0x0003, Seq: 5 (To Host)
23	7.716352	Cimsys_33:44:55	Motorola_1c:1d:1e	ethernet	20	ethernet II[Malformed Packet]	Ch: 0x0003, Seq: 8 (From Host)
24	7.716465	Cimsys_33:44:55	Motorola_1c:1d:1e	CSM_ENCAPS	30	--> 0x8018	Ch: 0x0003, Seq: 5 (To Host)
25	7.716711	Motorola_1c:1d:1e	Cimsys_33:44:55	CSM_ENCAPS	104	--> 0x805b	Ch: 0x0003, Seq: 8 (From Host)

► **Configurable capture options**

► **Getting start to customcapture**

This menu provides more options to capture specific packets as actually needs.

Network Capture

Default Setting: Custom

Network Interface: LAN DSP

Source Host:

Destination Host:

Select Port: None

Protocol(s): TCP UDP RTP RTCP ICMP ARP

Start Download Network Capture File...!

4.14.11 Voice Loopback Test

Voice Loopback test should be done on call status. Each call can do one kind of test. After each test, please hang up and call again, refresh web interface and go on the other tests.

Voice Loopback Test		
Port	Voice Loopback Test	
0	<input type="button" value="Dsp Tdm Test"/>	<input type="button" value="Dsp IP Test"/> <input type="button" value="Recover"/>
1	<input type="button" value="Dsp Tdm Test"/>	<input type="button" value="Dsp IP Test"/> <input type="button" value="Recover"/>
2	<input type="button" value="Dsp Tdm Test"/>	<input type="button" value="Dsp IP Test"/> <input type="button" value="Recover"/>
3	<input type="button" value="Dsp Tdm Test"/>	<input type="button" value="Dsp IP Test"/> <input type="button" value="Recover"/>
4	<input type="button" value="Dsp Tdm Test"/>	<input type="button" value="Dsp IP Test"/> <input type="button" value="Recover"/>
5	<input type="button" value="Dsp Tdm Test"/>	<input type="button" value="Dsp IP Test"/> <input type="button" value="Recover"/>
6	<input type="button" value="Dsp Tdm Test"/>	<input type="button" value="Dsp IP Test"/> <input type="button" value="Recover"/>
7	<input type="button" value="Dsp Tdm Test"/>	<input type="button" value="Dsp IP Test"/> <input type="button" value="Recover"/>

Voice stream patch on gateway:



▶ **DSP Tdm Test**

DSP TDM Test is the loopback of GSM side.

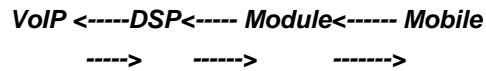

▶ **To start DSP TDM Test:**

- ◆ Make a call test through gateway, the call can be initiated by IPPHONE. Keep the conversation after call establish
- ◆ Click DSP TDM Test to start test
- ◆ Check the voice on both sides. VoIP side become silence and echo should be generated on Mobile phone side
- ◆ Hangup

▶ **To start DSP IP Test:**

DSP IP Test is the loopback of VoIP side.

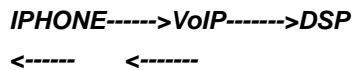

▶ **To start DSP IP Test:**

- ◆ Make a call test through gateway, the call can be initiated by IPPHONE. Keep the conversation after call establish
- ◆ Click DSP IP Test to start test
- ◆ Check the voice on both sides. GSM side become silence and echo should be generated on IPPHONE side
- ◆ Hangup

4.14.13 Username & Password

Figure 4-14-13 Username and Password

Username & Password

Web Configuration

Old Web Username

Old Web Password

New Web Username

New Web Password

Confirm Web Password

Telnet Configuration

Old Telnet Username

Old Telnet Password

New Telnet Username

New Telnet Password

Confirm Telnet Password

When using web or telnet Configuration, please enter default user name and password. User can modify the login name and password.

4.14.14 Factory Reset

Figure 4-14-14 Factory Reset

Factory Reset

Click this button to reset factory default settings

Be careful do this operation, after restore factory setting, all the parameters will be changed to the factory default.

4.14.15 Restart

Figure 4-14-15 Restart

Restart

Click this button to restart the device.

5. Troubleshooting and Command Line

5.1 Login DVG & General Knowledge of DWG Command

This is a document for some customers who need more details of D-LINK's products with command lines. To make sure the system runs successfully, we suggest customers setting DWG by GUI. In this manual, some topics such as how to check the IP, signaling and call conversation are covered.

Tips: The document is fit for all DVG-6008G models.

Run system tool Telnet to login DVG. The default username and password is "admin".

```
C:\Users\Administrator>telnet 172.16.101.142
```

```

Welcome to Command Shell!
Username:admin
Password:*****
ROS>

```

Input "?" to show the all commands and its information.

```

ROS>
ROS>?
    enable Turn on privileged commands
    exit   Exit from the EXEC
    show   Show running system information
ROS>

```

Abbreviation is supported in DVG command. For example you can input "en" substitute for "enable", input "sh" substitute for "show", input "cl" substitute for "clock",

```

ROS>
ROS>sho ?
    clock   Display the system clock
    version System hardware and software status
ROS>sho cl
12/14/2011 21:27:56
ROS>

```

5.2. Commands in "ROS#" Mode

There is only a litter commans in "ROS>" mode. If you need more commands you must enter the "ROS#" mode. Input "enable" to enter "ROS#" mode if you have in the "ROS>" mode.

```

ROS>
ROS>en
ROS#

```

5.2.1 Summarize of commands in "ROS#" mode

Input "?" to get the information of all commands in "ROS#" mode.

```

ROS#
ROS#?
  dbg                Show ada information
  dspconfigure       Configure device parameters
  exit               Exit from privelege mode
  menuconfigure      Configure system parameters
  ntp                 Configure ntp_sntp parameters
  ping               Send echo messages
  show               Show running system information
ROS#

```

5.2.2 General Purpose Commands in "ROS#" mode

▶ Show IP address (show int)

```

ROS#
ROS#sho int

Ethernet0/0/0 is up, line protocol is up
MTU is 1500 in bytes, Internet Address is owned, 192.168.11.1/24
IP Sending Frames' Format is PKTFMT_ETHNT_2, Hardware address is 001F.D6A0.023F

Ethernet0/0/1 is up, line protocol is up
MTU is 1500 in bytes, Internet Address is owned, 172.16.101.142/16
IP Sending Frames' Format is PKTFMT_ETHNT_2, Hardware address is 001F.D6A0.023F

ROS#_

```

▶ Show Time(show clock)

```

ROS#
ROS#sho cl
12/14/2011 21:19:13
ROS#

```

▶ Show version (show version)

```

ROS#sho ver
DWG2000D 2.22.01.04 PCB 2 LOGIC 0 BIOS 1, Built on Jun 19 2012, 15:26:51
ROS#_

```

► Show sip Information(show sip config)

```
ROS#
ROS#sho sip config
  local ipaddr   : 172.16.101.142
  keep alive    : on 10(s)
  message check : off
  noanswer time : 90(s)
  sip currentport : 5060
  T0            : 500(ms)
  T1            : 500(ms)
  T2            : 4000(ms)
  T4            : 5000(ms)
  TMax          : 32000(ms)
  do not reg    : off
  100rel       : off
  refererto use contact : off
  local port random : off
  client crypt  : off
  firewall ip   : 172.16.101.142
  firewall port : 5060
  dns type      : A Query
  dns refresh time : 0(min)
-----
  proxy id      : 0
  proxy domain  : 172.16.0.8
  proxy ip      : 172.16.0.8
  proxy port    : 2080
  reg interval  : 1800
ROS#
ROS#_
```

► Show memory status (show memory detail)

```

ROS#
ROS#sho memory detail
Addr(0x) Size      Mpe  Sid(0x)  Tick      Ref Line  File
4019f004 12          71   0        3607511   1   149   osip_port.c
4019f018 12          71   0        3607511   1   149   osip_port.c
4019f02c 12          71   0        3607511   1   149   osip_port.c
4019f040 12          71   0        3607511   1   149   osip_port.c
4019f054 12          71   0        3607511   1   149   osip_port.c
4019f068 12          71   0        3607511   1   149   osip_port.c
4019f07c 12          71   0        3607511   1   149   osip_port.c
4019f090 12          71   0        3607511   1   149   osip_port.c
4019f0a4 12          71   0        3607511   1   149   osip_port.c
4019f0b8 12          71   0        3607511   1   149   osip_port.c
4019f0cc 12          53   0        2955251   1   337   atchannel.c
4019f0e0 12          53   0        2955472   1   331   atchannel.c
4019f0f4 12          53   0         197      1  1362   atchannel.c
4019f108 12          53   0        2955550   1   331   atchannel.c
4019f180 12          53   0        2955503   1   337   atchannel.c
4019f1a8 12          53   0        2955305   1   337   atchannel.c
4019f1bc 12          53   0        2955518   1   331   atchannel.c
4019f1e4 12          53   0         196      1  1362   atchannel.c
4019f1f8 12          53   0        2955305   1   331   atchannel.c
4019f220 12          53   0        2955472   1   331   atchannel.c
4019f234 12          53   0        2955472   1   337   atchannel.c
4019f25c 12          53   0        2955518   1   337   atchannel.c
---- More < Press CTRL_C to break > ----

```

► Show SIP port status (show sip all)

```

ROS#
ROS#sho sip all
Index  UserId                      State      Expire(s)  RemainTime
-----
0      30                          OK         1800       976
1      31                          OK         1800       976
2      33                          OK         1800       976
ROS#

```

► Show Current calls (sh ecc call)

```

ROS#
ROS#sho ecc call
CcbNo  PortNo      Caller      Called      CcbState
-----
2      14          01212043684 01759408567 out_active
3      9           198257604   01715214621 out_active
6      5           H3258884    01830573560 out_active
13     3           bablohath    01710719124 out_active
16     8           0503298872  01720419701 out_recving
18     7           Mal106      01745599151 out_active
19     2           Jahid.2416  01831644239 out_active
22     0           22336688    01742670956 out_active
23     1           456789255   01834636875 out_active
-----
ROS#

```

► Show RTP session (sho rtp se)

```

ROS#
ROS#sho rtp se
RTP Information:
  RTP System TimeStamp 1586900(ms)
  MBUF Waiting for Playing 0, MBUF Discarded 0
EIA RTP Session List:
  PT-Payload Type, PP-Packet Period, PL-Packet Length,
  SP-Sample Period, SL-Sample Length, P/S-PP/SP, LR-NetLostRate, RLR-RealLostRate
-----
RTPNO Mode  PT   Send/ToDsp  LR/RLR      Local IP: Port      Peer IP: Port  PP  PL  SP  SL P/S  P2P  silence
-----
  0  STD  18   9250/9205   0/0         LocalHost: 8000     66.152.170.74:10562 20 20 20 20 1 NO  0
  2  STD  18   6499/6227   0/0         LocalHost: 8004     66.152.170.74:10658 20 20 20 20 1 NO  3
  4  STD  18   56225/56145 0/0         LocalHost: 8008     66.152.170.74: 9558 20 20 20 20 1 NO  0
  8  STD  18   13300/13201 0/0         LocalHost: 8016     66.152.170.74:10498 20 20 20 20 1 NO  1
 10  STD  4    7253/14451 0/0         LocalHost: 8020     64.15.152.90: 6042 60 48 60 48 1 NO  1
 14  STD  18   11745/11599 0/0         LocalHost: 8028     66.152.170.74:10522 20 20 20 20 1 NO  0
 16  STD  18    248/210    0/0         LocalHost: 8032     66.152.170.74:10766 20 20 20 20 1 NO  0
 18  STD  18   31800/31747 0/0         LocalHost: 8036     66.152.170.74:10186 20 20 20 20 1 NO  1
 20  STD  18   10499/10322 0/0         LocalHost: 8040     66.152.170.74:10554 20 20 20 20 1 NO  3
 24  STD  18   30028/29901 0/0         LocalHost: 8048     66.152.170.74:10198 20 20 20 20 1 NO  1
 26  STD  18   29614/6065  0/0         LocalHost: 8052     64.15.152.90:11854 20 20 20 20 1 NO  1
 28  STD  18   71018/70690 0/0         LocalHost: 8056     66.152.170.74: 9138 20 20 20 20 1 NO  1
-----
ROS#

```

► Show ASR/ACD statistics (show ecc state)

```

ROS#sho ecc state
PortNo  Call  Cancel  Timeout  NotAllowed  Connected  Busy  NoAnswer  NoDialTone  NoCarrier  SdpNegFailed  CallDelay
-----
  0      31      5        0         0           8          1          0           11          6            0            0
  1      24      6        0         0           9          0          0           5           4            0            0
  2      28     11        1         0          13          0          0           0           3            0            0
  3      24      5        0         0          12          1          0           0           6            0            0
  4      19      3        2         0          10          1          0           2           1            0            0
  5       0       0        0         0           0          0          0           0           0            0            0
  6      16      5        1         0           8          1          0           0           1            0            0
  7      11      3        0         0           8          0          0           0           0            0            0
  8       0       0        0         0           0          0          0           0           0            0            0
  9      12      3        0         0           7          1          0           0           1            0            0
 10     14      4        1         0           8          1          0           0           0            0            0
 11     24      8        0         0          11          2          0           0           3            0            0
 12     31     10        1         0          14          0          0           0           6            0            0
 13     28      7        3         0          11          2          0           1           4            0            0
 14      8       2        0         0           4          1          0           0           1            0            0
 15      0       0        0         0           0          0          0           0           0            0            0
-----
PortNo  Duration  ASR  ACD  ResetNoCar  ResetNoDil
-----
  0      2836    25  405         0           0
  1      5017    37  627         0           0
  2      1235    46  102         0           0
  3      5419    50  492         0           0
  4      5967    52  596         0           0
  5       0       0   0           0           0
  6      3715    50  530         0           0
  7      7799    72  1114        0           0
  8       0       0   0           0           0
  9      5692    58  948         0           0
 10     5711    57  713         0           0
 11     3199    45  290         0           0
 12     2451    45  188         0           0
 13     2002    39  200         0           0
 14     2592    50  864         0           0
 15       0       0   0           0           0
-----
ROS#_

```

5.3 Commands in "Config" Mode

5.3.1 Summarize of commands in "config" mode

Input "^config" in the "ROS# " to enter "config" mode.

```

ROS#
ROS#^config
ROS(config)#
ROS(config)#

```

Input "?" to show the all commands and its information.

```

ROS(config)#
ROS(config)#?
  bridge          set software forwarding in device
  clear           clear ip statistics
  clock           Manage the system clock
  config          configuration files handle
  debug           Debugging functions
  default         reset default
  dhs             dhcpserver enable!disable!reboot
  dhsconfig       Configure DHCP server
  dns-server      Configure DNS servers
  ecc             config ecc param
  ethmode        set ethernet workmode
  exit            Exit from configure mode
  host           Add or delete a host's name and IP address
  icmp           Config icmp send and receive redirect packet
  interface       Select an interface to configure
  ip             Config static route
  load           load commands
  mac            mac
  monitor        Copy debug output to the current terminal
  nat            nat cfg cmd
  no             Disable some parameter switches
  ppp            PPP
  product        Product default config
  reset          Reset the board
  rtp            RTP debug command
  save           save configuration
  sd            sd debug command
  setcustom      set custom
  shutdown       shutdown a user
  sip            config sip informations
  snmp-server    Modify SNMP parameters
  user_timeout   set telnet users timeout
  vlan           vlan route add or delete
  vlanif        vlan interface tagged properties
  webs           web server command
  workmode       network workmode selection:bridge or router
ROS(config)#
ROS(config)#

```

5.3.2 General Purpose Commands in "Config" mode

► Set time (clock set)

```

ROS(config)#
ROS(config)#clock ?
  set      Set the time and date,07/25/2003 13:25:43
ROS(config)#clock set 12/15/2011 11:46:35
ROS(config)#

```

► **Save the configuration (save)**

```
ROS<config>#
ROS<config>#save
ROS<config>#
```

► **Restart device (reset eia)**

```
ROS<config>#
ROS<config>#reset
Are you sure to reset? (y/n):y
ROS<config>#
```

► **Enable debug**

The command format is `deb port + port number`, to enable port 0 debug, as below:

```
ROS<config>#
ROS<config>#deb port 0
Succ! Debug PortNo:0
```

```
ROS<config>#
```

To enable all ports debug, with the command “`deb port all`”

```
ROS<config>#deb port all
Debug All!!
```

```
ROS<config>#
```

Without this steps, no trace logs will display on output window

► **Enable SIP debug (deb sip msg all)**

```
ROS<config>#
ROS<config>#deb sip msg all
ROS<config>#
```

5.4 How to trace SIP logs

Create telnet session to gateway, the main steps as below:

```
Welcome to Command Shell!
Username:admin
Password:*****
ROS>en
ROS#
ROS#^config
ROS(config)#deb sip msg all
ROS(config)#ex
```

```
ROS#
ROS#^ada
ROS(ada)#ADA CONNECTED ...,WELCOME!
ROS(ada)#
ROS(ada)#turnon 71
Disable sip trace:
ROS(ada)#turnoff 71
```

5.5 How to trace ECC logs (Call Details)

```
Welcome to Command Shell!
Username:admin
Password:*****
ROS>en
ROS#
ROS#^config
ROS(config)#deb port all
Debug All!!.
//enable trace on all port
ROS(config)#
ROS(config)#deb port 0
Succ! Debug PortNo:0
// enable trace port 0
ROS(config)#
ROS(config)#no deb port all
ROS(config)#
ROS(config)#ex
ROS#^ada
ROS(ada)#ADA CONNECTED ...,WELCOME!
ROS(ada)#turnon 84
Disable trace:
ROS(ada)#turnoff 84
```

5.6 How to trace Module logs

```
Welcome to Command Shell!
Username:admin
Password:*****
ROS>en
ROS#^ada
ROS(ada)#ADA CONNECTED ...,WELCOME!
ROS(ada)#cmd 53 19 0 0 1
```

```
// enable trace. 0 0 means port range 0 to 0, 0 8 means port range from 0 to 8; 1 means  
enable module trace  
ROS(ada)#cmd 53 19 0 0 0  
//disable module trace
```

6. The Way to Increase Antenna Isolation

Several methods are introduced in this document to decrease the interfering effect among antennas with close mounting position.

6.1 Isolate by distance

figure-6.1 Theoretic distance value for GSM band

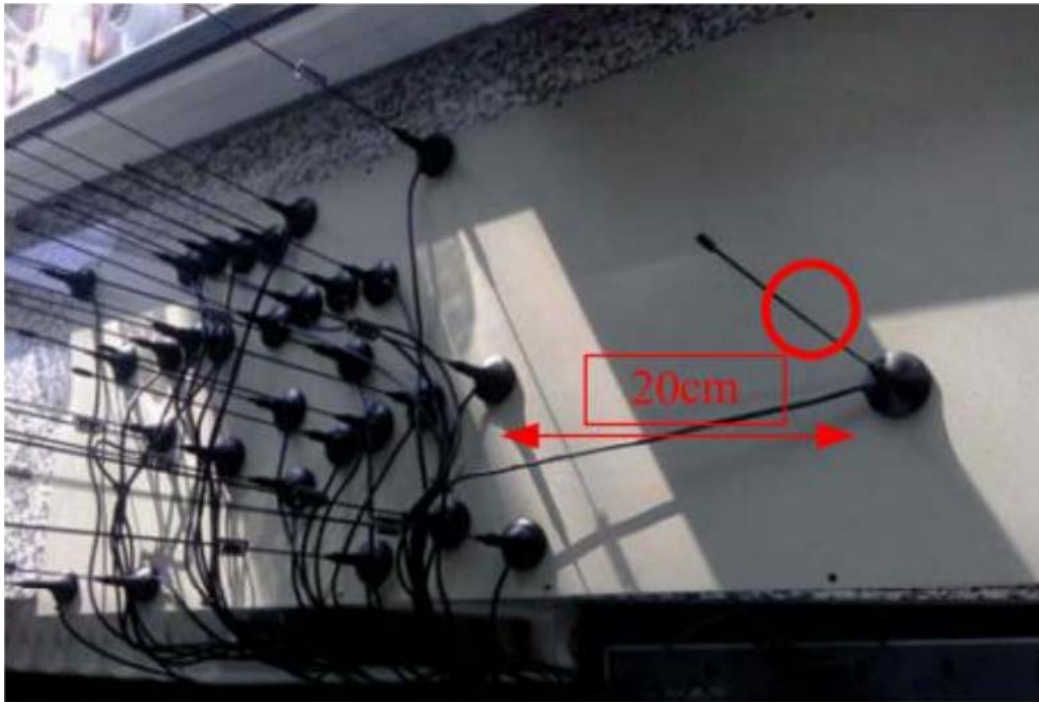

Keep distance between antennas as far as possible. In theory, the distance between antennas should be more than half of the operating wavelength. For GSM band, the recommended distance value is more than 20cm. In practical application, the experiment value is no less than 15cm for better isolation.

6.2 Isolate by metal shielding baffles among antenna

Put a metal shielding baffle between antennas, which can help to prevent radiation signal coupling from each other. If the metal baffle is big enough, the isolation will be unlimited big in theory.

Figure 6.2 Isolation by metal shielding baffles



6.3 Isolate by antenna orthogonal polarization

Figure 6.3 Isolation by antenna orthogonal polarization



In theory, the isolation is unlimited big if the polarization is really orthogonal, like vertical polarization VS horizontal antenna; RHCP (Right Hand CircularPolarization) VS LHCP (Left Hand Circular Polarization).

In real practical application, the antenna are all elliptic polarization, they have a certain ratio. So putting the same type antennas in orthogonal position will be helpful for isolation.

6.4 Isolate by antenna radiation pattern

Radiation pattern of low directivity antenna

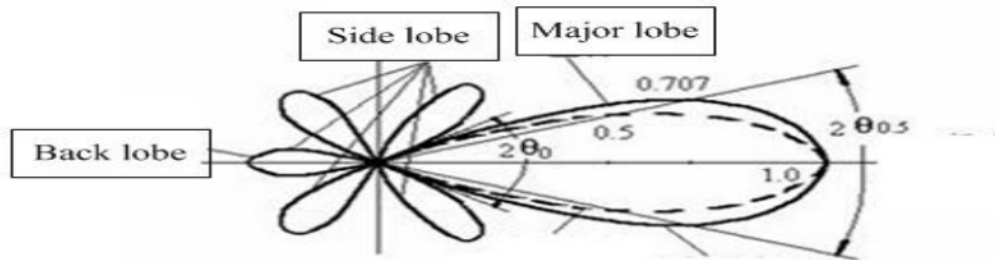
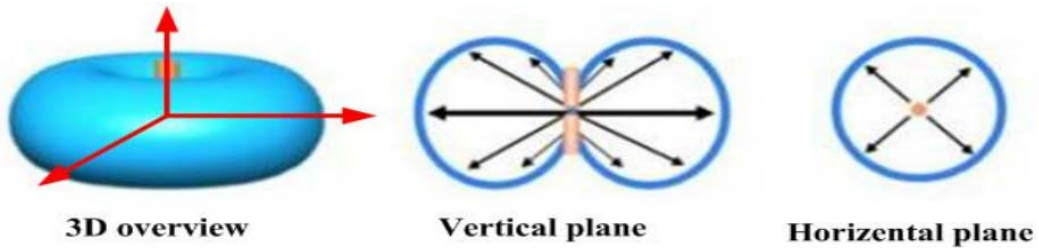

radiation pattern of high directivity antenna

Recommended placement with nonmetal shelf

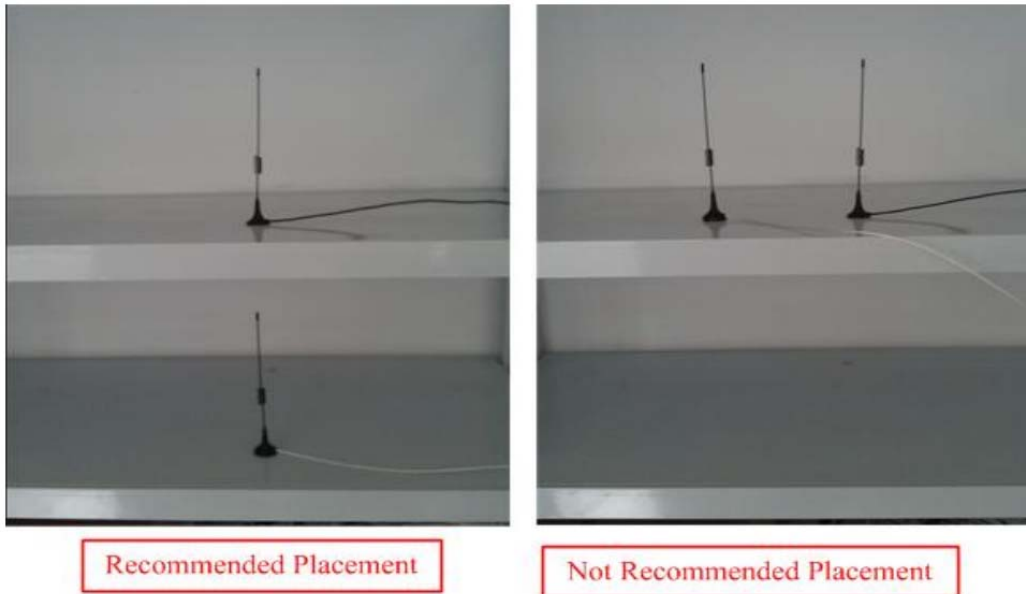

Try to modify the antenna mounting position, avoid the major lobe of both antenna overlap, which is also an effective way for high isolation among different antennas, especially for high directivity antenna.

It might be difficult to find a perfect position to stagger the major lobe for low directivity antennas, two factors cause this, one is the major lobe is very broad, the other is the radiation pattern is affected by surroundings sensitively.

For common antenna we often use, most of them belong to low directivity type, we can put the antennas in a nonmetal shelf, and place antennas in vertical form, not in horizontal form, which can help to avoid antennas major lobe overlap and make the isolation bigger in some degree.

7. Frequency Asked Questions

7.1 Device have been connected to network physically, but cannot access the gateway

- 1) Make sure the network cable is ok , can through view the device network port indicator light to determine the physical connection is working or not;
- 2) Make sure the connected network devices (router, switch or hub) support 10M/100M adaptive, if not, connect the Equipment directly to PC, landing WEB and in the "local connection" Configuration interface Select the correct Ethernet Work Mode;

- 3) Check the Network Configuration, if the Configuration is incorrect, please re-Configuration. If you are using DHCP mode, check DHCP Server is working properly;
- 4) Check whether there is a LAN device conflict with the exists IP ADDRESS.

7.2 Equipment cannot register

If the Run LED does not flash mean unregistered

- 1) Check the network connection is working (see above section), whether the Configuration is correct;
- 2) Check whether the LAN firewall setting is inappropriate (such whether limit the network communication); If it is, there are two ways to try to resolve;
- 3) Check whether the Local Network to the SIP PROXY platform network environment is relatively poor or not, and if so, please check Local Network or contact the service provider;
- 4) if go through those steps, the device still be in trouble, please contact the equipment provider;

7.3 When calling out, the callee's phone shows wrong caller ID

- 1) Ask the callee checks whether the device is failure or device battery power is low
- 2) Make sure the callee has been subscribed called User ID display service
- 3) If only part of the caller User ID with this problem, please contact the telecom carrier.

7.4 Sudden interruption during a call

- 1) make sure whether is human error caused the problem
- 2) Check the balance.
- 3) Make sure whether the LAN equipment such as gateway or router fails, user can try to restart the gateway or router

7.5 Voice single-pass, double-barrier or poor quality

- 1) Make sure the equipment is working properly with grounded power
- 2) Check the device network connection is in working status
- 3) Ask network administrators to open limitation with the equipment's network communications (it is a special equipment, not afraid of virus attacks); (2) try to enable the equipment tunnel (through the WEB for Configuration, Also, please NOTE, open the tunnel will impact voice quality, Please do not enable the tunnel as far as possible, refer WEB

Configuration Interface Description section)

4) Make sure the LAN equipment is working, user can try to restart the gateway or router to solve the problem

5) Check whether there is more than one D-LINK series products in LAN network: some gateways or routers, processing network packet is vulnerable (for example, to multiple network devices or the same protocol network communication, NAT allocated the same conversion communications Channel). If there is such a case, suggest replacing a router or specify each voice gateway with different LOCAL RTP PORT Channel (refer to the base WEB Configuration interface section)

6) Check the equipment network environment for the softswitch platform, monitor the network condition, make sure the network is solid

8. Glossary

GSM: Global System for Mobile Communications

CDMA: Code Division Multiple Access

FMC: Fixed Mobile Convergence

SIP: Session Initiation Protocol

MGCP: Media Gateway Control Protocol

DTMF: Dual Tone Multi Frequency

USSD: Unstructured Supplementary Service Data

PSTN: Public Switched Telephone Network

STUN: Simple Traversal of UDP over NAT

IVR: Interactive Voice Response

IMSI: International Mobile Subscriber Identification Number

IMEI: International Mobile Equipment Identity

DMZ: Demilitarized Zone

API: Application programming Interface

BCCH: Broadcast Control Channel

LAC: Location Area Code

CID: Cell ID

BTS: Base Transceiver Station

DTMF: Dual-Tone Multifrequency

IVR: Interactive Voice Response

NAT: Network Address Translation

RTP: Real-time Transport Protocol

VoIP: Voice over IP