



User Manual

Wireless AC 1750 Dual Band Cloud Router

Preface

D-Link reserves the right to revise this publication and to make changes in the content hereof without obligation to notify any person or organization of such revisions or changes.

Manual Revisions

Revision	Date	Description
1.0	May 17, 2012	• Initial release for Revision A1

Trademarks

D-Link and the D-Link logo are trademarks or registered trademarks of D-Link Corporation or its subsidiaries in the United States or other countries. All other company or product names mentioned herein are trademarks or registered trademarks of their respective companies.

Copyright © 2012 by D-Link Systems, Inc.

All rights reserved. This publication may not be reproduced, in whole or in part, without prior expressed written permission from D-Link Systems, Inc.

Table of Contents

Preface	i	Static (assigned by ISP)	36
Manual Revisions	i	PPPoE (DSL)	37
Trademarks	i	PPTP	39
Product Overview	1	L2TP	41
Package Contents	1	DS-Lite	43
System Requirements	2	Wireless connection setup wizard	44
Introduction	3	Wi-Fi Protected Setup Wizard	47
Features	4	Manual wireless network setup	48
Hardware Overview	5	Bridge Mode	57
Connections	5	Wireless Security	61
LEDs	6	What is WPA?	61
Installation	7	Network Settings	62
Before you Begin	7	Router Settings	62
Wireless Installation Considerations	8	DHCP Server Settings	63
Manual Setup	9	DHCP Reservation	65
Connect to an Existing Router	11	Parental Control	66
Configuration	13	Storage	67
Quick Setup Wizard	14	IPv6	70
QRS Mobile App	21	IPv6 Internet Connection Setup Wizard	71
SharePort Mobile App	22	IPv6 Manual Setup	76
Web-based Configuration Utility	26	mydlink Settings	85
Internet Connection Setup	27	Advanced	88
Internet Connection Setup Wizard	28	Virtual Server	88
Internet (Manual)	34	Port Forwarding	89
		Application Rules	90
		QoS Engine	91

Network Filters.....	93	Statistics	122
Access Control.....	94	Internet Sessions.....	123
Website Filters.....	97	Routing	124
Inbound Filters.....	98	Wireless.....	125
Firewall Settings	99	IPv6	126
Routing	101	IPV6 Routing	127
Advanced Wireless	102	Support	128
Wi-Fi Protected Setup (WPS)	103	Connect a Wireless Client to your Router	129
Advanced Network Settings	105	WPS Button.....	129
DLNA Settings.....	106	Windows® 7.....	130
iTunes Server	107	WPA/WPA2	130
Guest Zone	108	WPS.....	133
IPv6 Firewall	109	Windows Vista®	137
IPv6 Routing	110	WPA/WPA2	138
Tools	111	WPS/WCN 2.0	140
Admin.....	111	Windows® XP.....	141
Time	112	WPA/WPA2	142
SysLog.....	113	Troubleshooting	144
Email Settings.....	114	Wireless Basics	148
System	115	What is Wireless?.....	149
Firmware	116	Tips.....	151
Language Pack.....	116	Wireless Modes.....	152
Dynamic DNS	117	Networking Basics	153
System Check	118	Check your IP address.....	153
Schedules	119	Statically Assign an IP address	154
Status	120	Technical Specifications	155
Device Info	120		
Logs.....	121		

Package Contents

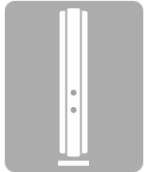

DIR-865L Wireless AC 1750 Dual Band Cloud Router

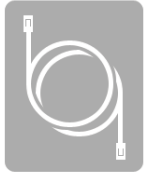

Ethernet Cable



Power Adapter



WI-FI Configuration Note

If any of the above items are missing, please contact your reseller.

Note: Using a power supply with a different voltage rating than the one included with the DIR-865L will cause damage and void the warranty for this product.

System Requirements

<p>Network Requirements</p>	<ul style="list-style-type: none"> • An Ethernet-based Cable or DSL modem • IEEE 802.11ac, 802.11a, 802.11n or 802.11g wireless clients • 10/100/1000 Ethernet
<p>Web-based Configuration Utility Requirements</p>	<p>Computer with the following:</p> <ul style="list-style-type: none"> • Windows®, Macintosh, or Linux-based operating system • An installed Ethernet adapter <p>Browser Requirements:</p> <ul style="list-style-type: none"> • Internet Explorer 7 or higher • Firefox 3.5 or higher • Safari 4 or higher • Chrome 8 or higher <p>Windows® Users: Make sure you have the latest version of Java installed. Visit www.java.com to download the latest version.</p>
<p>mydlink Requirements</p>	<ul style="list-style-type: none"> • iPhone/iPad/iPod Touch (iOS 3.0 or higher) • Android device (1.6 or higher) • Computer with the following browser requirements: <ul style="list-style-type: none"> • Internet Explorer 7 or higher • Firefox 3 or higher • Safari 5 or higher • Chrome 5 or higher <p><small>iPhone, iPad, and iPod touch are registered trademarks of Apple Inc. Android is a trademark of Google, Inc.</small></p>

Introduction

Now you can monitor and manage your home network right from your laptop, iPhone®, iPad®, or Android™ device. The cloud-enabled router can be configured to send an email to keep you informed anywhere, anytime when new devices are connecting to your network or unwanted access is detected. Monitor in realtime websites that are being visited with recent browser history displayed on the mydlink™ Lite app – which is great for parents. The D-Link Cloud Service can detect and block unwelcomed guests who try to get into your wireless network and suspicious activities will be displayed right on your mydlink™ Lite app or browser.

The D-Link DIR-865L is a IEEE 802.11ac compliant device that delivers up to 3 times faster speeds than 802.11n while staying backward compatible with 802.11a/g/b devices. Connect the DIR-865L to a Cable or DSL modem and provide high-speed Internet access to multiple computers, game consoles, and media players. Create a secure wireless network to share photos, files, music, videos, printers, and network storage. Powered by the 802.11ac technology and equipped with six internal antennas, this router provides superior wireless coverage for larger homes and offices, or for users running bandwidth-intensive applications. The DIR-865L also includes a 4-port 10/100/1000 Gigabit switch that connects Gigabit wired devices for enjoying lag-free network gaming and faster file transfers.

D-Link has created SharePort™ technology to bring more flexibility to your network. With SharePort™ technology, you can connect a USB printer and share it throughout your network. You can also share a USB storage device, providing network storage for everyone to share.

With some routers, all wired and wireless traffic, including VoIP, Video Streaming, Online Gaming, and Web browsing are mixed together into a single data stream. By handling data this way, applications like video streaming could pause or delay. With the D-Link Intelligent QoS Technology, wired and wireless traffic are analyzed and separated into multiple data streams.

The DIR-865L supports the latest wireless security features to help prevent unauthorized access, be it from over a wireless network or the Internet. Support for WPA™ and WPA2™ standards ensure that you will be able to use the best possible encryption regardless of your client devices. In addition, this router utilizes Dual Active Firewalls (SPI and NAT) to prevent potential attacks from across the Internet for the ideal centerpiece for your wireless network in the home or office.

Features

- **Ultimate Fast Wireless Networking** - The DIR-865L provides up to 450Mbps wireless connection in 2.4GHz band, 1300Mbps wireless connection in 5GHz with other 802.11ac and draft 802.11n wireless clients. This capability allows users to participate in real-time activities online, such as video streaming, online gaming, and real-time audio. The performance of this 802.11n wireless router gives you the freedom of wireless networking at speeds 3x faster than 802.11n.
- **Compatible with 802.11a/g/n Devices** - The DIR-865L is still fully compatible with the IEEE 802.11a, 802.11g and 802.11n, so it can connect with existing 802.11a, 802.11g and 802.11n PCI, USB, and Cardbus adapters.
- **Advanced Firewall Features** - The Web-based user interface displays a number of advanced network management features including:
 - **Content Filtering** - Easily applied content filtering based on MAC Address, URL, and/or Domain Name.
 - **Filter Scheduling** - These filters can be scheduled to be active on certain days or for a duration of hours or minutes.
 - **Secure Multiple/Concurrent Sessions** - The DIR-865L can pass through VPN sessions. It supports multiple and concurrent IPSec and PPTP sessions, so users behind the DIR-865L can securely access corporate networks.
- **User-friendly Setup Wizard** - Through its easy-to-use Web-based user interface, the DIR-865L lets you control what information is accessible to those on the wireless network, whether from the Internet or from your company's server. Configure your router to your specific settings within minutes.

* Maximum wireless signal rate derived from IEEE Standard 802.11a, 802.11g, 802.11n and draft 802.11ac specifications. Actual data throughput will vary. Network conditions and environmental factors, including volume of network traffic, building materials and construction, and network overhead, lower actual data throughput rate. Environmental conditions will adversely affect wireless signal range.

Hardware Overview

Connections

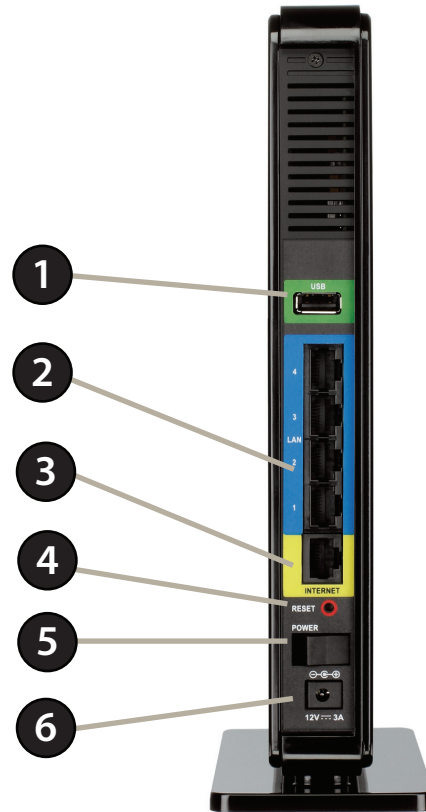

1	USB Port	Connect a USB flash drive to share content throughout your network.
2	LAN Ports (1-4)	Connect 10/100/1000 Ethernet devices such as computers, switches, storage (NAS) devices and game consoles.
3	Internet Port	Using an Ethernet cable, connect your broadband modem to this port.
4	Reset Button	Press the button to restore the device to its original factory default settings.
5	Power Button	Press the power button to power on and off.
6	Power Receptor	Receptor for the supplied power adapter.

Hardware Overview

LEDs

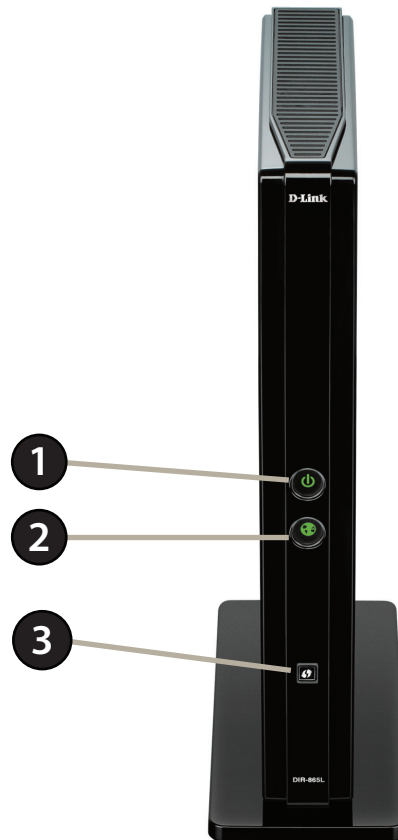

1	Power LED	A solid light indicates connection on the Internet port and the router can connect to the Internet. If the LED is orange, the connection is good but the router cannot connect to the Internet.
2	Internet LED	A solid light indicates connection on the Internet port. If the LED is orange, the connection is good but the router cannot connect to the Internet.
3	WPS Button	Press to start the WPS process. The Power LED will start to blink.

Installation

This section will walk you through the installation process. Placement of the router is very important. Do not place the router in an enclosed area such as a closet, cabinet, or in the attic or garage.

Before you Begin

- Please configure the router with the computer that was last connected directly to your modem.
- You can only use the Ethernet port on your modem. If you were using the USB connection before using the router, then you must turn off your modem, disconnect the USB cable and connect an Ethernet cable to the Internet port on the router, and then turn the modem back on. In some cases, you may need to call your ISP to change connection types (USB to Ethernet).
- If you have DSL and are connecting via PPPoE, make sure you disable or uninstall any PPPoE software such as WinPoet, Broadjump, or Enternet 300 from your computer or you will not be able to connect to the Internet.

Wireless Installation Considerations

The D-Link wireless router lets you access your network using a wireless connection from virtually anywhere within the operating range of your wireless network. Keep in mind, however, that the number, thickness and location of walls, ceilings, or other objects that the wireless signals must pass through, may limit the range. Typical ranges vary depending on the types of materials and background RF (radio frequency) noise in your home or business. The key to maximizing wireless range is to follow these basic guidelines:

1. Keep the number of walls and ceilings between the D-Link router and other network devices to a minimum - each wall or ceiling can reduce your adapter's range from 3-90 feet (1-30 meters.) Position your devices so that the number of walls or ceilings is minimized.
2. Be aware of the direct line between network devices. A wall that is 1.5 feet thick (.5 meters), at a 45-degree angle appears to be almost 3 feet (1 meter) thick. At a 2-degree angle it looks over 42 feet (14 meters) thick! Position devices so that the signal will travel straight through a wall or ceiling (instead of at an angle) for better reception.
3. Building Materials make a difference. A solid metal door or aluminum studs may have a negative effect on range. Try to position access points, wireless routers, and computers so that the signal passes through drywall or open doorways. Materials and objects such as glass, steel, metal, walls with insulation, water (fish tanks), mirrors, file cabinets, brick, and concrete will degrade your wireless signal.
4. Keep your product away (at least 3-6 feet or 1-2 meters) from electrical devices or appliances that generate RF noise.
5. If you are using 2.4GHz cordless phones or X-10 (wireless products such as ceiling fans, lights, and home security systems), your wireless connection may degrade dramatically or drop completely. Make sure your 2.4GHz phone base is as far away from your wireless devices as possible. The base transmits a signal even if the phone is not in use.

Manual Setup

1. Turn off and unplug your cable or DSL broadband modem. This is required.

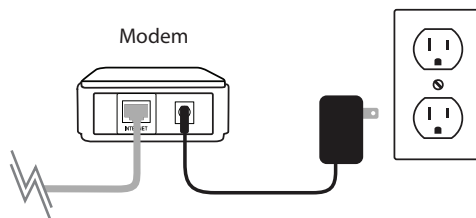

2. Position your router close to your modem and a computer. Place the router in an open area of your intended work area for better wireless coverage.
3. Unplug the Ethernet cable from your modem (or existing router if upgrading) that is connected to your computer. Plug it into the LAN port labeled **1** on the back of your router. The router is now connected to your computer.

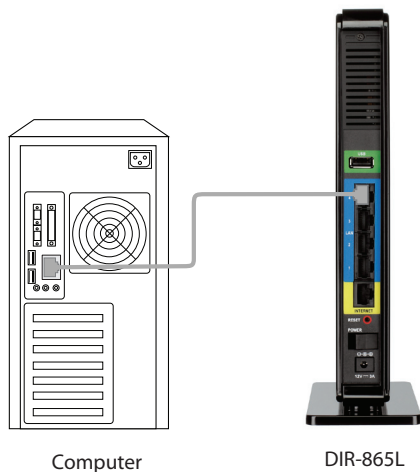

4. Plug one end of the included blue Ethernet cable that came with your router into the yellow port labeled INTERNET on the back of the router. Plug the other end of this cable into the Ethernet port on your modem.

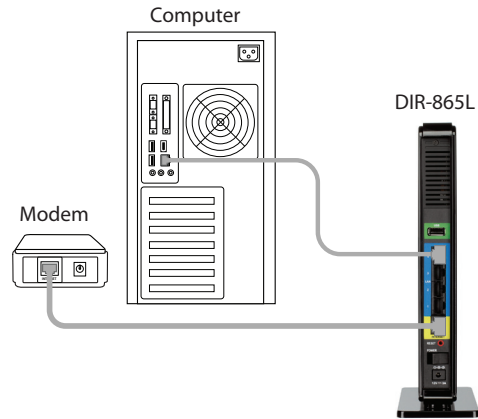

5. Reconnect the power adapter to your cable or DSL broadband modem and wait for two minutes.
6. Connect the supplied power adapter into the power port on the back of the router and then plug it into a power outlet or surge protector. Press the power button and verify that the power LED is lit. Allow 1 minute for the router to boot up.

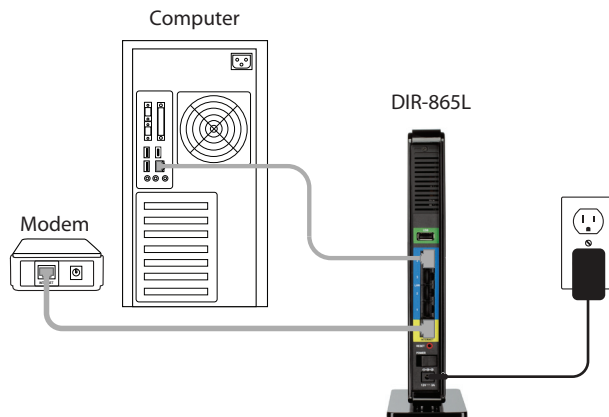

7. If you are connecting to a Broadband service that uses a dynamic connection (not PPPoE), you may be online already. Try opening a web browser and enter a web site. If a solid light indicates connection on the Internet port and the router can connect to the Internet. If the LED is orange, the connection is good but the router cannot connect to the Internet.

Connect to an Existing Router

Note: *It is strongly recommended to replace your existing router with the DIR-865L instead of using both. If your modem is a combo router, you may want to contact your ISP or manufacturer's user guide to put the router into Bridge mode, which will 'turn off' the router (NAT) functions.*

If you are connecting the DIR-865L router to an existing router to use as a wireless access point and/or switch, you will have to do the following to the DIR-865L before connecting it to your network:

- Disable UPnP™
- Disable DHCP
- Change the LAN IP address to an available address on your network. The LAN ports on the router cannot accept a DHCP address from your other router.

To connect to another router, please follow the steps below:

1. Plug the power into the router. Connect one of your computers to the router (LAN port) using an Ethernet cable. Make sure your IP address on the computer is 192.168.0.xxx (where xxx is between 2 and 254). Please see the **Networking Basics** section for more information. If you need to change the settings, write down your existing settings before making any changes. In most cases, your computer should be set to receive an IP address automatically in which case you will not have to do anything to your computer.
2. Open a web browser, enter **http://192.168.0.1** and press **Enter**. When the login window appears, set the user name to **Admin** and leave the password box empty. Click **Log In** to continue.
3. Click on **Advanced** and then click **Advanced Network**. Uncheck the **Enable UPnP** checkbox. Click **Save Settings** to continue.
4. Click **Setup** and then click **Network Settings**. Uncheck the **Enable DHCP Server** checkbox. Click **Save Settings** to continue.

5. Under Router Settings, enter an available IP address and the subnet mask of your network. Click **Save Settings** to save your settings. Use this new IP address to access the configuration utility of the router in the future. Close the browser and change your computer's IP settings back to the original values as in Step 1.
6. Disconnect the Ethernet cable from the router and reconnect your computer to your network.
7. Connect an Ethernet cable in one of the **LAN** ports of the router and connect it to your other router. Do not plug anything into the Internet (WAN) port of the D-Link router.
8. You may now use the other 3 LAN ports to connect other Ethernet devices and computers. To configure your wireless network, open a web browser and enter the IP address you assigned to the router. Refer to the **Configuration** and **Wireless Security** sections for more information on setting up your wireless network.

Configuration

There are several different ways you can configure your router to connect to the Internet and connect to your clients:

- **D-Link Setup Wizard** - This wizard will launch when you log into the router for the first time. Refer to page 14.
- **QRS Mobile App** - Use your iPhone, iPad, or iPod Touch to configure your router. Refer to page 21
- **Manual Setup** - Log into the router and manually configure your router (advanced users only). Refer to page 27.

Quick Setup Wizard

If this is your first time installing the router, open your web browser. You will automatically be directed to the **Wizard Setup Screen**. If not, enter "http://dlinkrouter.local". Then, press Enter.

If you have already configured your settings and you would like to access the configuration utility, please refer to page 27.

If this is your first time logging into the router, this wizard will start automatically.

This wizard is designed to guide you through a step-by-step process to configure your new D-Link router and connect to the Internet.

Click **Next** to continue.

Please wait while your router detects your internet connection type. If the router detects your Internet connection, you may need to enter your ISP information such as username and password.

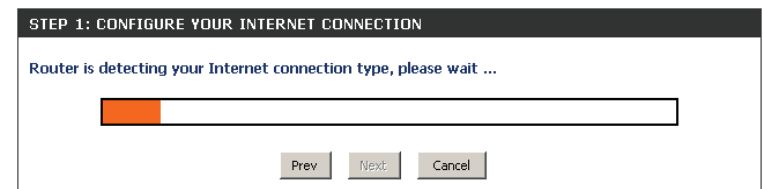
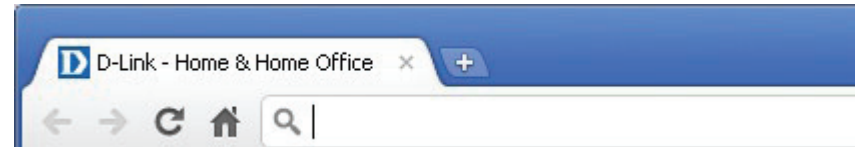

If the router does not detect a valid Ethernet connection from the Internet port, this screen will appear. Connect your broadband modem to the Internet port and then click **Try Again**.

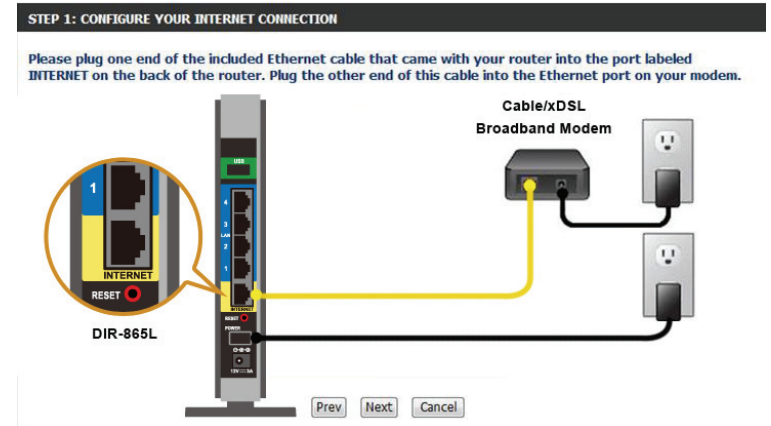

If the router detects an Ethernet connection but does not detect the type of Internet connection you have, this screen will appear. Click **Guide me through the Internet Connection Settings** to display a list of connection types to choose from.

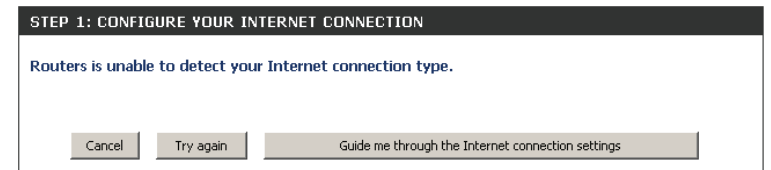

Select your Internet connection type and click **Next** to continue.

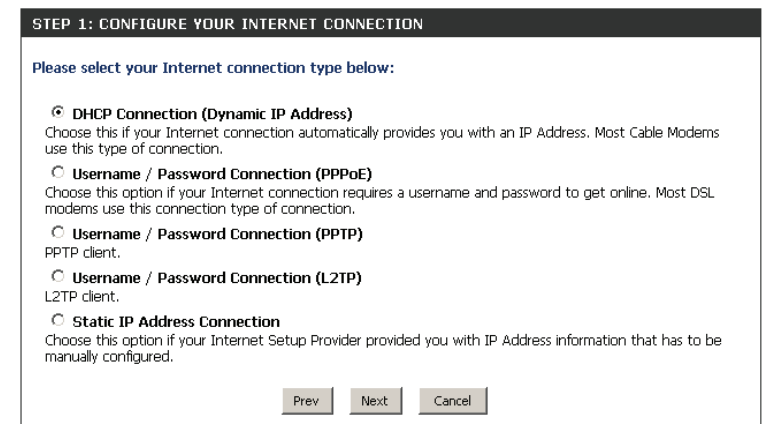

If the router detected or you selected **PPPoE**, enter your PPPoE username and password and click **Next** to continue.

Note: Make sure to remove your PPPoE software from your computer. The software is no longer needed and will not work through a router.

If the router detected or you selected **PPTP**, enter your PPTP username, password, and other information supplied by your ISP. Click **Next** to continue.

If the router detected or you selected **L2TP**, enter your L2TP username, password, and other information supplied by your ISP. Click **Next** to continue.

SET USERNAME AND PASSWORD CONNECTION (PPPoE)

To set up this connection you will need to have a Username and Password from your Internet Service Provider. If you do not have this information, please contact your ISP.

User Name :

Password :

SET USERNAME AND PASSWORD CONNECTION (PPTP)

To set up this connection you will need to have a Username and Password from your Internet Service Provider. You also need PPTP IP address. If you do not have this information, please contact your ISP.

Address Mode : Dynamic IP Static IP

PPTP IP Address :

PPTP Subnet Mask :

PPTP Gateway IP Address :

PPTP Server IP Address (may be same as gateway) :

User Name :

Password :

Verify Password :

DNS SETTINGS

Primary DNS Address :

Secondary DNS Address :

SET USERNAME AND PASSWORD CONNECTION (L2TP)

To set up this connection you will need to have a Username and Password from your Internet Service Provider. You also need L2TP IP address. If you do not have this information, please contact your ISP.

Address Mode : Dynamic IP Static IP

L2TP IP Address :

L2TP Subnet Mask :

L2TP Gateway IP Address :

L2TP Server IP Address (may be same as gateway) :

User Name :

Password :

Verify Password :

DNS SETTINGS

Primary DNS Address :

Secondary DNS Address :

If the router detected or you selected **Static**, enter the IP and DNS settings supplied by your ISP. Click **Next** to continue.

SET STATIC IP ADDRESS CONNECTION

To set up this connection you will need to have a complete list of IP information provided by your Internet Service Provider. If you have a Static IP connection and do not have this information, please contact your ISP.

IP Address :

Subnet Mask :

Gateway Address :

DNS SETTINGS

Primary DNS Address :

Secondary DNS Address :

For both the 2.4GHz and 5GHz segments, create a Wi-Fi network name (SSID) using up to 32 characters.

Create a Wi-Fi password (between 8-63 characters). Your wireless clients will need to have this passphrase or key entered to be able to connect to your wireless network.

Click **Next** to continue.

STEP 2: CONFIGURE YOUR WI-FI SECURITY

Give your Wi-Fi network a name and a password. (2.4GHz Band)

Wi-Fi Network Name (SSID) : (Using up to 32 characters)

Wi-Fi Password : (Between 8 and 63 characters)

Give your Wi-Fi network a name and a password. (5GHz Band)

Wi-Fi Network Name (SSID) : (Using up to 32 characters)

Wi-Fi Password : (Between 8 and 63 characters)

In order to secure your router, please enter a new password. Check the Enable Graphical Authentication box to enable CAPTCHA authentication for added security. Click **Next** to continue.

STEP 3: SET YOUR PASSWORD

By default, your new D-Link Router does not have a password configured for administrator access to the Web-based configuration pages. To secure your new networking device, please set and verify a password below, and enabling CAPTCHA Graphical Authentication provides added security protection to prevent unauthorized online users and hacker software from accessing your network settings.

Password:

Verify Password :

Enable Graphical Authentication :

Select your time zone from the drop-down menu and click **Next** to continue.

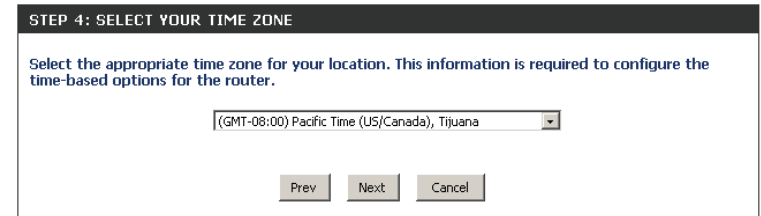

The Setup Complete window will display your Wi-Fi settings. Click **Save and Connect** to continue.

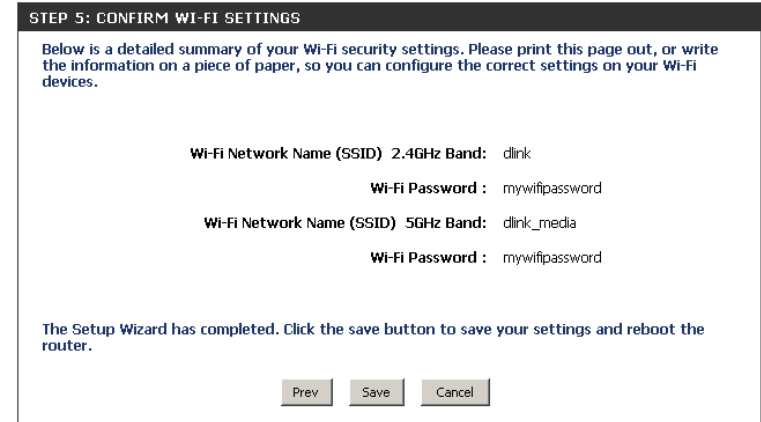

If you want to create a bookmark to the router, click **OK**. Click **Cancel** if you do not want to create a bookmark.

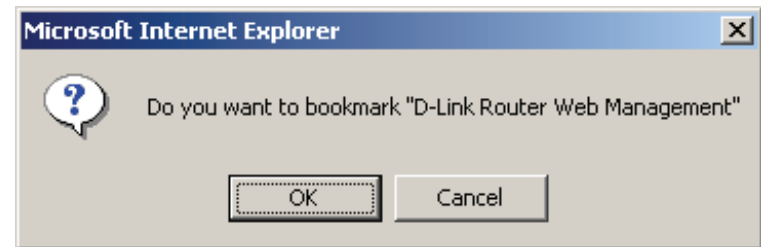

If you clicked **Yes**, a window may appear (depending on what web browser you are using) to create a bookmark.

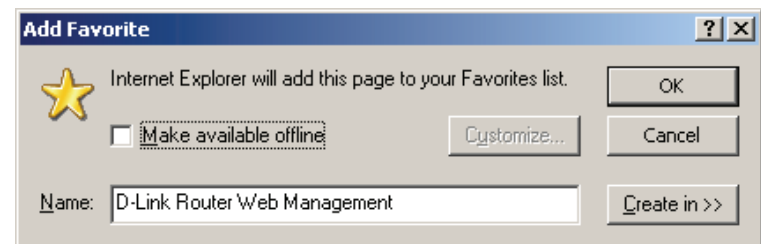

To use the mydlink service (mydlink.com or the mydlink Lite app), you must have an account. Select if you do have a mydlink account or if you need to create one. Click **Next** to continue.

If you do not want to register at this time, click **Cancel**.

If you clicked **Yes**, enter your mydlink account name (email address) and password. Click **Login** to register your router.

If you clicked **No**, fill out the requested information and click **Sign Up** to create your mydlink account.

MYDLINK REGISTRATION

To use the features of mydlink.com and the mydlink Lite app, you will need an account with mydlink.com. If you already have an account, select **Yes, I have a mydlink account** and click **Next** to register the router with mydlink.com. If you do not have an account, select **No, I want to register and login with a new mydlink account** and click **Next** to create an account. If you do not wish to sign up for the mydlink service, please click **Cancel**.

Do you have mydlink account?

Yes, I have a mydlink account.

No, I want to register and login with a new mydlink account.

STEP 6: MYDLINK REGISTRATION

E-mail Address (Account Name):

Password:

STEP 6: MYDLINK REGISTRATION

Please fulfill the options to complete the registration.

E-mail Address (Account Name) :

Password :

Confirm Password :

First Name :

Last name :

[I Accept the mydlink terms and conditions.](#)

The mydlink App will allow you to receive notices, browse network users, and configure your router from an iPhone/iPad/iPod Touch (iOS 3.0 or higher), Android device (1.6 or higher).

To download the "mydlink lite" app, visit the Apple Store, Android Market or <http://mydlink.com/Lite>.

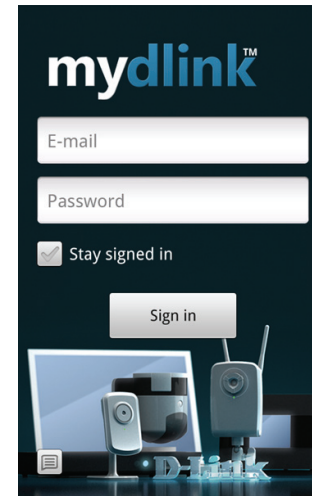

PC and Mac users can use the mydlink portal at <http://mydlink.com>.

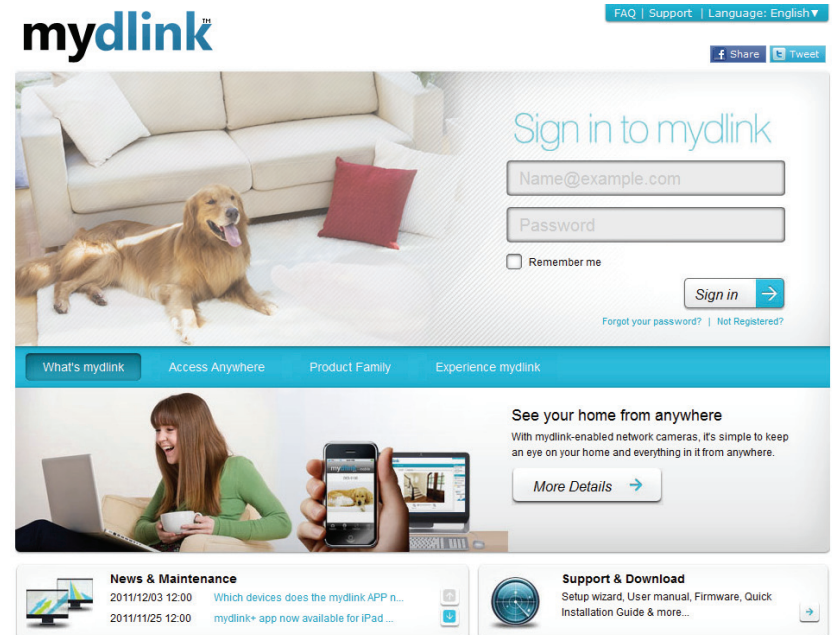

QRS Mobile App

D-Link offers an app for your iPad, iPod Touch, or iPhone (iOS 4.3 or higher) to install and configure your router.

Step 1

From your iPad, Touch, or iPhone, go to the iTunes Store and search for 'D-Link'. Select **QRS Mobile** and then download it.

You may also scan this code to download.



Step 2

Once your app is installed, you may now configure your router. Connect to the router wirelessly by going to your wireless utility on your device. Scan for the Wi-Fi name (SSID) as listed on the supplied info card. Select and then enter your Wi-Fi password.

D-Link DIR-826L Mobile Companion Wi-Fi Configuration Note

Web browser link: http://dlinkrouter or http://192.168.0.1	Web browser link: http://dlinkrouter or http://192.168.0.1
Default configuration Username: "Admin" Password: "" (leave the field blank)	Your configuration Username: Admin Password:
Wi-Fi Name (SSID): dlink-a8fa	Wi-Fi Name (SSID):
Wi-Fi Password: akbdj19368	Wi-Fi Password:

Step 3

Once you connect to the router, launch the QRS mobile app and it will guide you through the installation of your router.

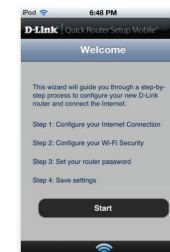

SharePort Mobile App

The SharePort Mobile app will allow you to access files from a USB thumb drive that is plugged into your router. You must enable file sharing from the **Setup > Storage** page (refer to page 68) for this app to work properly.

1. Insert your USB flash drive into DIR-865L.

2. Scan the bar code to download the **SharePort Mobile APP** from the app store to your iPhone or iPad.



3. From your iOS mobile device, click **Settings**.



Settings

4. Click **Wi-Fi**, select the Wi-Fi Network Name (SSID) that you created in the setup and then enter your Wi-Fi password.

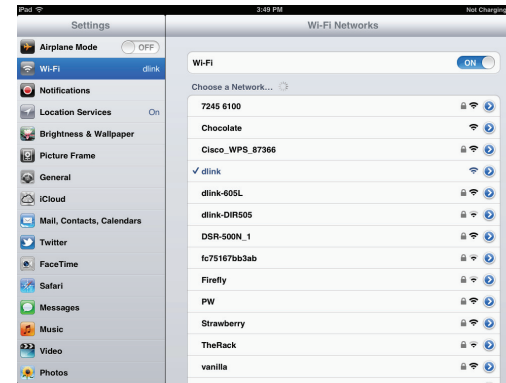

5. Once connected, click on the **SharePort Mobile** icon.



6. The following screen will appear.

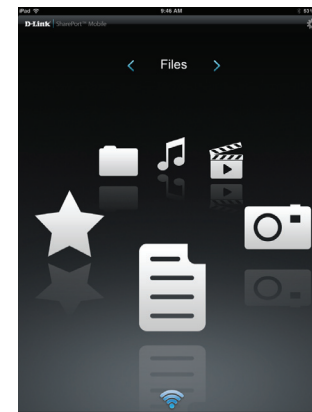

7. Click on **Settings** icon located on the right top corner of the screen. Click **Edit** to enter your User Name and Password. Once you finish, click **Done** to continue.

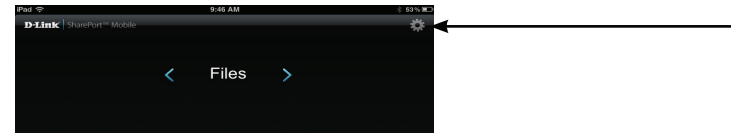

8. For the Movie section, click the movie icon to play your movie from your USB flash drive.

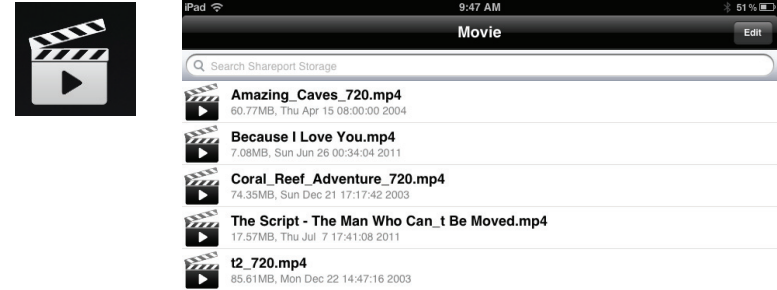

9. For the Music section, click the music icon to play your music from your USB flash drive.

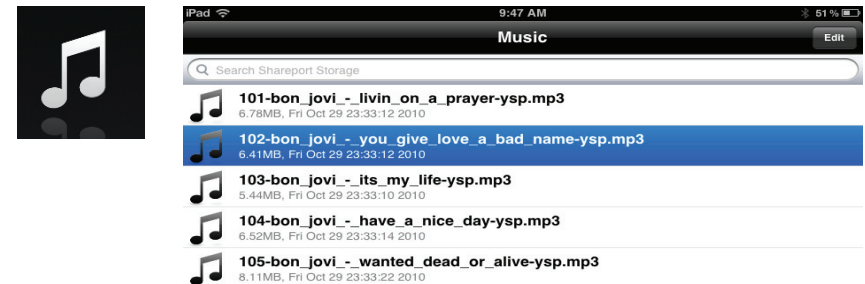

10. For the Photo section, click the Photo icon to view your photos from your USB flash drive.

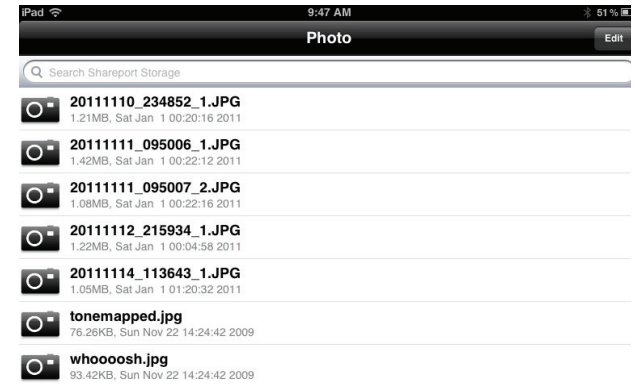

11. For the Files section, click on the Files icon to view your files from your USB flash drive.

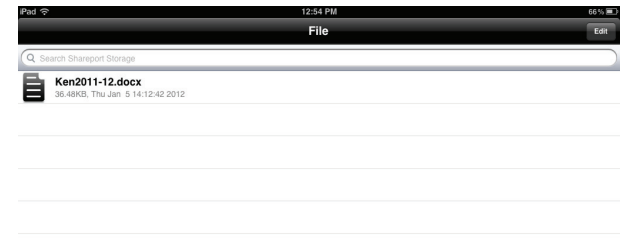

12. For the Folder section, click the folder icon to view your folders from your USB flash drive.

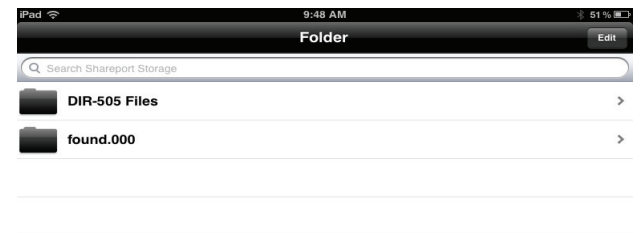
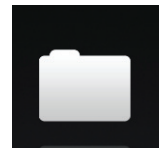

Web-based Configuration Utility

To access the configuration utility, open a web-browser such as Internet Explorer and enter address of the router (**http://dlinkrouter.local** or **http://192.168.0.1**).

Non-Windows and Non-Mac users may also connect by typing **http://192.168.0.1** in the address bar.

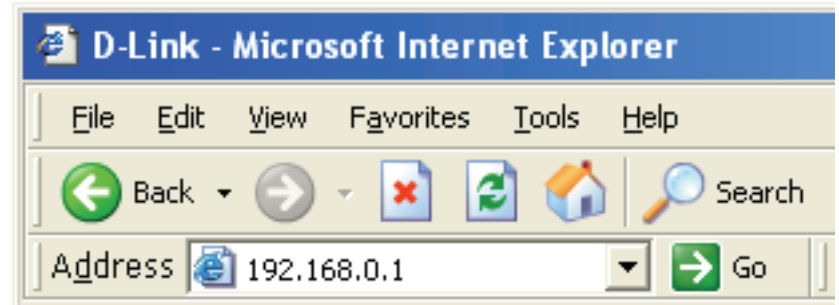

Leave the password blank by default.

A screenshot of the router's web-based configuration utility login page. The page has an orange header with the word "LOGIN" in white. Below the header, the text "Login to the router :" is displayed. There are two input fields: "User Name : Admin" and "Password :". A "Login" button is located to the right of the password field.

Internet Connection Setup

Click **Manual Internet Connection Setup** to configure your connection manually and continue to the next page.

If you want to configure your router to connect to the Internet using the wizard, click **Internet Connection Setup Wizard**. You will be directed to the Quick Setup Wizard.

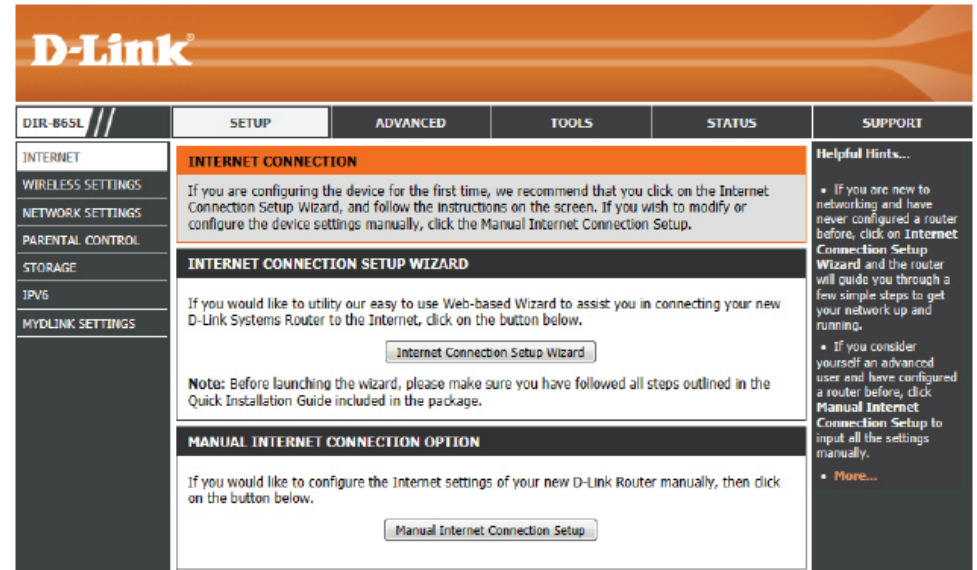

The screenshot displays the D-Link web interface for the DIR-865L router. The top navigation bar includes 'D-Link' and tabs for 'SETUP', 'ADVANCED', 'TOOLS', 'STATUS', and 'SUPPORT'. The left sidebar lists menu items: 'INTERNET', 'WIRELESS SETTINGS', 'NETWORK SETTINGS', 'PARENTAL CONTROL', 'STORAGE', 'IPv6', and 'MYDLINK SETTINGS'. The main content area is titled 'INTERNET CONNECTION' and provides instructions for first-time users, recommending the 'Internet Connection Setup Wizard'. Below this, there is a section for the 'INTERNET CONNECTION SETUP WIZARD' with a button labeled 'Internet Connection Setup Wizard'. A note advises users to follow the Quick Installation Guide before launching the wizard. The final section is 'MANUAL INTERNET CONNECTION OPTION' with a button labeled 'Manual Internet Connection Setup'. A 'Helpful Hints...' sidebar on the right offers additional guidance for new users and advanced users.

DIR-865L	SETUP	ADVANCED	TOOLS	STATUS	SUPPORT
INTERNET	INTERNET CONNECTION If you are configuring the device for the first time, we recommend that you click on the Internet Connection Setup Wizard, and follow the instructions on the screen. If you wish to modify or configure the device settings manually, click the Manual Internet Connection Setup.				Helpful Hints... <ul style="list-style-type: none">• If you are new to networking and have never configured a router before, click on Internet Connection Setup Wizard and the router will guide you through a few simple steps to get your network up and running.• If you consider yourself an advanced user and have configured a router before, click Manual Internet Connection Setup to input all the settings manually.• More...
WIRELESS SETTINGS	INTERNET CONNECTION SETUP WIZARD If you would like to utilize our easy to use Web-based Wizard to assist you in connecting your new D-Link Systems Router to the Internet, click on the button below. <input type="button" value="Internet Connection Setup Wizard"/>				
NETWORK SETTINGS	MANUAL INTERNET CONNECTION OPTION If you would like to configure the Internet settings of your new D-Link Router manually, then click on the button below. <input type="button" value="Manual Internet Connection Setup"/>				
PARENTAL CONTROL					
STORAGE					
IPv6					
MYDLINK SETTINGS					

Internet Connection Setup Wizard

When configuring the router for the first time, we recommend that you click use the **Internet Connection Setup Wizard**, and follow the instructions on the screen. This wizard is designed to assist user with a quick and easy method to configure the Internet Connectivity of this router.

Anytime during the Internet Connection Setup Wizard, the user can click on the **Cancel** button to discard any changes made and return to the main Internet page. Also the user can click on the **Prev** button, to return to the previous window for re-configuration.

Welcome:

This wizard will guide you through a step-by-step process to configure your new D-Link router and connect to the Internet. Click **Next** to continue.

Step 1: Set Your Password

By default, the D-Link Router does not have a password configured for administrator access to the Web-based configuration pages. To secure your new networking device, please enter and verify a password in the spaces provided. The two passwords must match.

Click **Next** to continue.

INTERNET CONNECTION

If you are configuring the device for the first time, we recommend that you click on the Internet Connection Setup Wizard, and follow the instructions on the screen. If you wish to modify or configure the device settings manually, click the Manual Internet Connection Setup.

INTERNET CONNECTION SETUP WIZARD

If you would like to utilize our easy to use Web-based Wizard to assist you in connecting your new D-Link Systems Router to the Internet, click on the button below.

Internet Connection Setup Wizard

Note: Before launching the wizard, please make sure you have followed all steps outlined in the Quick Installation Guide included in the package.

WELCOME TO THE D-LINK INTERNET CONNECTION SETUP WIZARD

This wizard will guide you through a step-by-step process to configure your new D-Link router and connect to the Internet.

- Step 1: Set your Password
- Step 2: Select your Time Zone
- Step 3: Configure your Internet Connection
- Step 4: Save Settings and Connect

Prev Next Cancel Connect

STEP 1: SET YOUR PASSWORD

By default, your new D-Link Router does not have a password configured for administrator access to the Web-based configuration pages. To secure your new networking device, please set and verify a password below:

Password :
Verify Password :

Prev Next Cancel Connect

Step 2: Select Your Time Zone

Select the appropriate time zone for your location. This information is required to configure the time-based options for the router.

Click **Next** to continue.

Step 3: Internet Connection

Here the user will be able to configure the Internet Connectivity used by this device. If your ISP connection is listed in the drop-down menu select it and click **Next**. If your ISP connection is not listed then you can proceed to select any of the other manual Internet Connection methods listed below.

The following parameters will be available for configuration:

Dynamic IP Address: Choose this if your Internet connection automatically provides you with an IP Address. Most Cable Modems use this type of connection.

PPPoE: Choose this option if your Internet connection requires a PPPoE username and password to get online. Most DSL modems use this type of connection.

PPTP: Choose this option if your Internet connection requires a PPTP username and password to get online.

L2TP: Choose this option if your Internet connection requires an L2TP username and password to get online.

Static IP Address: Choose this option if your Internet Setup Provider provided you with IP Address information that has to be manually configured.

The screenshot shows a configuration window titled "STEP 2: SELECT YOUR TIME ZONE". The text inside reads: "Select the appropriate time zone for your location. This information is required to configure the time-based options for the router." Below this text is a dropdown menu labeled "Time Zone" with the selected value "(GMT+08:00) Taipei". At the bottom of the window are four buttons: "Prev", "Next", "Cancel", and "Connect".

The screenshot shows a configuration window titled "STEP 3: CONFIGURE YOUR INTERNET CONNECTION". The text inside reads: "Your Internet Connection could not be detected, please select your Internet Service Provider (ISP) from the list below. If your ISP is not listed; select the 'Not Listed or Don't Know' option to manually configure your connection." Below this text is a dropdown menu with the selected value "Not Listed or Don't Know". The text continues: "If your Internet Service Provider was not listed or you don't know who it is, please select the Internet connection type below:". There are five radio button options, each with a description: "DHCP Connection (Dynamic IP Address)", "Username / Password Connection (PPPoE)", "Username / Password Connection (PPTP)", "Username / Password Connection (L2TP)", and "Static IP Address Connection". At the bottom of the window are four buttons: "Prev", "Next", "Cancel", and "Connect".

Step 3: Internet Connection (Dynamic IP Address)

After selecting the Dynamic IP Address Internet connection method, the following page will appear.

The following parameters will be available for configuration:

MAC Address: Enter the MAC address of the Internet gateway (plugged into the Internet port of this device) here.

Clone Button: If the configuration PC also acts as the Internet gateway, then click on the Clone Your PC's MAC Address button to copy the PC's MAC address into the space provided. If you're not sure, leave the MAC Address field blank.

Host Name: Enter the host name used here. You may also need to provide a Host Name. If you do not have or know this information, please contact your ISP.

Primary DNS Address: Enter the Primary DNS IP address used here.

Secondary DNS Address: Enter the Secondary DNS IP address used here. This field is normally optional. Only one DNS address is required for a functional Internet connection, but using a second DNS address provides more stability.

DHCP CONNECTION (DYNAMIC IP ADDRESS)

To set up this connection, please make sure that you are connected to the D-Link Router with the PC that was originally connected to your broadband connection. If you are, then click the Clone MAC button to copy your computer's MAC Address to the D-Link Router.

MAC Address : (optional)
Clone Your PC's MAC Address

Host Name : dlinkrouter

Note: You may also need to provide a Host Name. If you do not have or know this information, please contact your ISP.

DNS SETTINGS

Primary DNS Address :
Secondary DNS Address : (optional)

Prev Next Cancel Connect

Click **Next** to continue.

Step 3: Internet Connection (PPPoE)

After selecting the PPPoE Internet connection method, the following page will appear:

The following parameters will be available for configuration:

User Name: Enter the PPPoE account user name used here. This information is given by the ISP.

Password: Enter the PPPoE account password used here. This information is given by the ISP.

SET USERNAME AND PASSWORD CONNECTION (PPPOE)

To set up this connection you will need to have a Username and Password from your Internet Service Provider. If you do not have this information, please contact your ISP.

User Name :
Password :

Prev Next Cancel Connect

Click **Next** to continue.

Step 3: Internet Connection (PPTP)

After selecting the PPTP Internet connection method, the following page will appear:

The following parameters will be available for configuration:

Address Mode: Here the user can specify whether this Internet connection requires the use of a Dynamic or Static IP address. PPTP usual requires a Dynamic IP configuration.

PPTP IP Address: Enter the PPTP IP address used here. This option is only available if Static IP is selected.

PPTP Subnet Mask: Enter the PPTP Subnet Mask used here.

PPTP Gateway IP Address: Enter the PPTP Gateway IP address used here.

PPTP Server IP Address: Enter the PPTP Server IP address used here. This is normally the same as the PPTP Gateway IP address.

User Name: Enter the PPTP username used here.

Password: Enter the PPTP password used here.

Verify Password: Re-enter the PPTP password used here.

Primary DNS Address: Enter the Primary DNS IP address used here.

Secondary DNS Address: Enter the Secondary DNS IP address used here. This field is normally optional. Only one DNS address is required for a functional Internet connection, but using a second DNS address provides more stability.

Click **Next** to continue.

SET USERNAME AND PASSWORD CONNECTION (PPTP)

To set up this connection you will need to have a Username and Password from your Internet Service Provider. You also need PPTP IP address. If you do not have this information, please contact your ISP.

Address Mode : Dynamic IP Static IP

PPTP IP Address :

PPTP Subnet Mask :

PPTP Gateway IP Address :

PPTP Server IP Address : (may be same as gateway)

User Name :

Password :

Verify Password :

DNS SETTINGS

Primary DNS Address :

Secondary DNS Address : (optional)

Step 3: Internet Connection (L2TP)

After selecting the L2TP Internet connection method, the following page will appear:

The following parameters will be available for configuration:

Address Mode: Here the user can specify whether this Internet connection requires the use of a Dynamic or Static IP address. L2TP usual requires a Dynamic IP configuration.

L2TP IP Address: Enter the L2TP IP address used here. This option is only available if Static IP is selected.

L2TP Subnet Mask: Enter the L2TP Subnet Mask used here.

L2TP Gateway IP Address: Enter the L2TP Gateway IP address used here.

L2TP Server IP Address: Enter the L2TP Server IP address used here. This is normally the same as the L2TP Gateway IP address.

User Name: Enter the L2TP username used here.

Password: Enter the L2TP password used here.

Verify Password: Re-enter the L2TP password used here.

Primary DNS Address: Enter the Primary DNS IP address used here.

Secondary DNS Address: Enter the Secondary DNS IP address used here. This field is normally optional. Only one DNS address is required for a functional Internet connection, but using a second DNS address provides more stability.

Click **Next** to continue.

The screenshot displays a configuration window titled "SET USERNAME AND PASSWORD CONNECTION (L2TP)". It contains a header with instructions: "To set up this connection you will need to have a Username and Password from your Internet Service Provider. You also need L2TP IP address. If you do not have this information, please contact your ISP." Below this, there are several input fields and radio buttons. The "Address Mode" section has two radio buttons: "Dynamic IP" (selected) and "Static IP". The "L2TP IP Address" field contains "0.0.0.0". The "L2TP Subnet Mask" field contains "0.0.0.0". The "L2TP Gateway IP Address" field contains "0.0.0.0". The "L2TP Server IP Address" field contains "0.0.0.0" with a note "(may be same as gateway)". There are three text input fields for "User Name", "Password", and "Verify Password". Below these fields is a section titled "DNS SETTINGS" with two text input fields: "Primary DNS Address" and "Secondary DNS Address" (with a note "(optional)"). At the bottom of the window are four buttons: "Prev", "Next", "Cancel", and "Connect".

Step 3: Internet Connection (Static IP Address)

After selecting the Static IP Address Internet connection method, the following page will appear:

The following parameters will be available for configuration:

IP Address: Enter the Static IP address provided by the ISP here.

Subnet Mask: Enter the Subnet Mask provided by the ISP here.

Gateway Address: Enter the Gateway IP address provided by the ISP here.

Primary DNS Address: Enter the Primary DNS IP address used here.

Secondary DNS Address: Enter the Secondary DNS IP address used here. This field is normally optional. Only one DNS address is required for a functional Internet connection, but using a second DNS address provides more stability.

Click **Next** to continue.

Setup Complete!

This is the last page of the Internet Connection Setup Wizard.

Click the **Connect** button to save your settings.

The screenshot shows a configuration window titled "SET STATIC IP ADDRESS CONNECTION". It contains a warning message: "To set up this connection you will need to have a complete list of IP information provided by your Internet Service Provider. If you have a Static IP connection and do not have this information, please contact your ISP." Below the message are three input fields: "IP Address" with value "0.0.0.0", "Subnet Mask" with value "0.0.0.0", and "Gateway Address" with value "0.0.0.0". A section titled "DNS SETTINGS" contains two input fields: "Primary DNS Address" with value "0.0.0.0" and "Secondary DNS Address" with value "0.0.0.0" and "(optional)" to its right. At the bottom are four buttons: "Prev", "Next", "Cancel", and "Connect".

The screenshot shows a confirmation window titled "SETUP COMPLETE!". It contains the message: "The Internet Connection Setup Wizard has completed. Click the Connect button to save your settings." At the bottom are four buttons: "Prev", "Next", "Cancel", and "Connect".

Internet (Manual)

On this page the user can configure the Internet Connection settings manually. To access the Manual Internet Connection Setup page, click on the **Manual Internet Connection Setup** button. On this page there are multiple parameters that can be configured regarding the Internet Connection setup. We'll discuss them from top to bottom.

At any given point the user can save the configuration done, on this page, by clicking on the **Save Settings** button. If you choose to discard the changes made, click on the **Don't Save Settings** button.

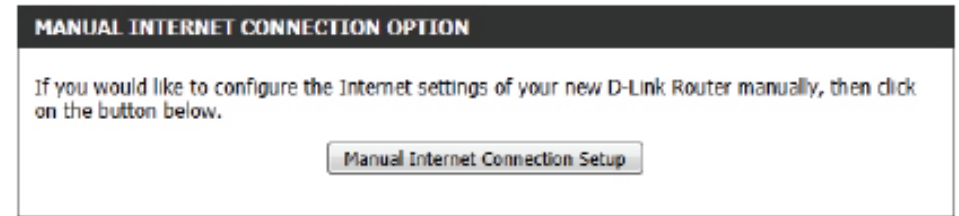

In the **Bridge Mode** section, the user can enable the Bridge Mode. This feature will change the functionality of this router completely. If this feature is **disabled**, this router will function as a **normal wireless router**. However, after **enabling** this feature **all routing functionality of this device will be disabled** and it will only function as a **Wireless Bridge**. Changing this device to act as a Wireless Bridge allows us to utilize this device to connect to another DIR-865L wirelessly. By doing so we can utilize the IEEE 802.11ac connection speed to its optimum speed.

The following parameters will be available for configuration:

Enable Bridge Mode: Tick this option to enable the bridge mode setting.

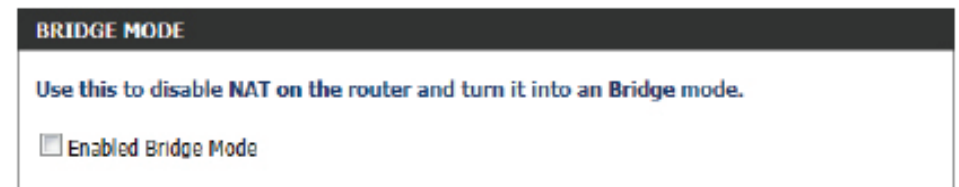

After applying the Bridge Mode, the device's IP address will change. This screen capture shows us the confirmation window that will be displayed after applying the Bridge Mode setting.

Note: The DIR-865L's IP address will change to 192.168.0.50. After the device has restarted, enter <http://192.168.0.50> into the web browser's address bar to reconnect to this device's Web User Interface.

Refer to "[Wireless Settings \(Bridge Mode\)](#)" on page 58 for more details.

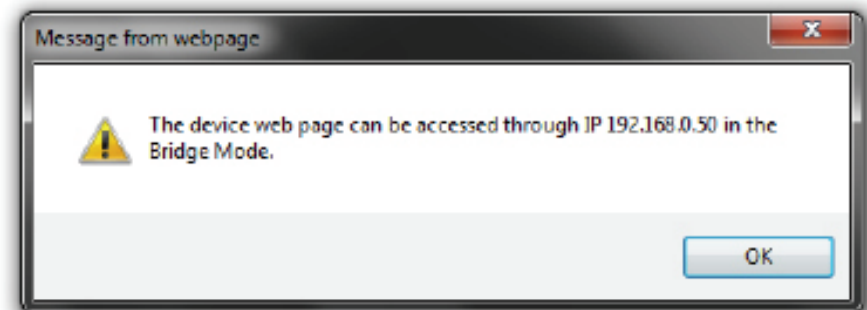

Internet Connection Type

In this section, the user can select from a list of Internet Connection types that can be configured and used on this router. Options to choose from are **Static IP**, **Dynamic IP**, **PPPoE**, **PPTP**, **L2TP**, and **DS-Lite**.

After selecting a specific Internet Connection type, this page will automatically refresh and provide unique fields to configure related to the specified Internet Connection type.

My Internet Connection is: Dynamic IP (DHCP)

The default WAN configuration for this router is Dynamic IP (DHCP). This option allows the router to obtain an IP address automatically from the device that is connected to the Internet port.

Note: If you're not sure about the type of Internet Connection you have, please contact your Internet Service Provider (ISP) for assistance.

After selecting Dynamic IP, the following parameters will be available for configuration:

- Host Name:** The Host Name is optional but may be required by some ISPs. Leave blank if you are not sure.
- Use Unicasting:** Tick this option if you ISP uses the unicast method to provide IP addresses.
- Primary DNS:** Enter the Primary DNS IP address used here.
- Secondary DNS:** Enter the Secondary DNS IP address used here. This field is normally optional. Only one DNS address is required for a functional Internet connection, but using a second DNS address provides more stability.

MTU: Maximum Transmission Unit - you may need to change the MTU for optimal performance with your specific ISP. 1500 is the default MTU.

MAC Address: The default MAC Address is set to the Internet port's physical interface MAC address on the Broadband Router. It is not recommended that you change the default MAC address unless required by your ISP. You can use the **Clone Your PC's MAC Address** button to replace the Internet port's MAC address with the MAC address of your Ethernet card.



INTERNET CONNECTION TYPE

Choose the mode to be used by the router to connect to the Internet.

My Internet Connection is :

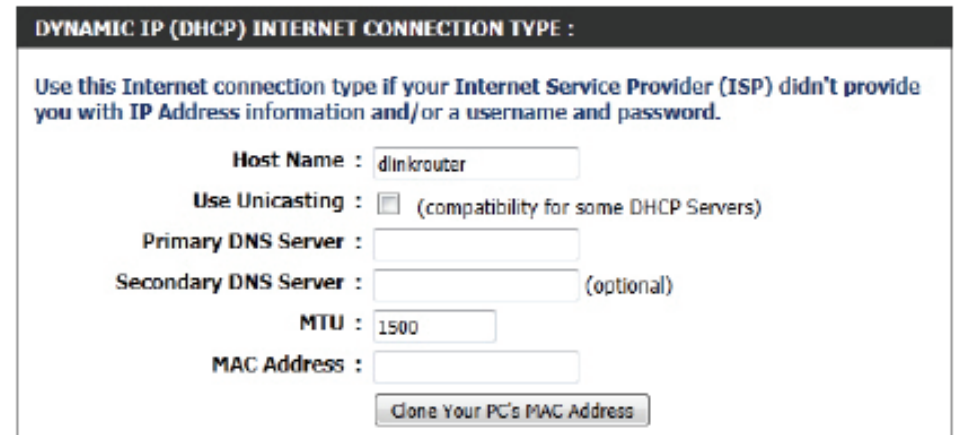

DYNAMIC IP (DHCP) INTERNET CONNECTION TYPE :

Use this Internet connection type if your Internet Service Provider (ISP) didn't provide you with IP Address information and/or a username and password.

Host Name :

Use Unicasting : (compatibility for some DHCP Servers)

Primary DNS Server :

Secondary DNS Server : (optional)

MTU :

MAC Address :

Manual Internet Setup

Static (assigned by ISP)

Select Static IP Address if all the Internet port's IP information is provided to you by your ISP. You will need to enter in the IP address, subnet mask, gateway address, and DNS address(es) provided to you by your ISP. Each IP address entered in the fields must be in the appropriate IP form, which are four octets separated by a dot (x.x.x.x). The Router will not accept the IP address if it is not in this format.

My Internet Connection: Select **Static IP** to manually enter the IP settings supplied by your ISP.

IP Address: Enter the IP address assigned by your ISP.

Subnet Mask: Enter the Subnet Mask assigned by your ISP.

Default Gateway: Enter the Gateway assigned by your ISP.

DNS Servers: The DNS server information will be supplied by your ISP (Internet Service Provider.)

MTU: Maximum Transmission Unit - you may need to change the MTU for optimal performance with your specific ISP. 1500 is the default MTU.

MAC Address: The default MAC Address is set to the Internet port's physical interface MAC address on the Broadband Router. It is not recommended that you change the default MAC address unless required by your ISP. You can use the **Copy Your PC's MAC Address** button to replace the Internet port's MAC address with the MAC address of your Ethernet card.

INTERNET CONNECTION TYPE

Choose the mode to be used by the router to connect to the Internet.

My Internet Connection is :

STATIC IP ADDRESS INTERNET CONNECTION TYPE

Enter the static address information provided by your Internet Service Provider (ISP).

IP Address :

Subnet Mask :

Default Gateway :

Primary DNS Server :

Secondary DNS Server :

MTU : (bytes) MTU default = 1500

MAC Address :

Internet Setup

PPPoE (DSL)

Choose PPPoE (Point to Point Protocol over Ethernet) if your ISP uses a PPPoE connection. Your ISP will provide you with a username and password. This option is typically used for DSL services. Make sure to remove your PPPoE software from your computer. The software is no longer needed and will not work through a router.

My Internet Connection: Select **PPPoE (Username/Password)** from the drop-down menu.

Address Mode: Here the user can specify whether this Internet connection requires the use of a **Dynamic** or **Static IP** address. PPPoE usually requires a Dynamic IP configuration.

IP Address: Enter the PPPoE IP address used here. This option is only available if Static IP is selected.

Username: Enter the PPPoE account user name used here. This information is given by the ISP.

Password: Enter the PPPoE account password used here. This information is given by the ISP.

Verify Password: Re-enter the PPPoE account password used here.

Service Name: This optional field enables the user to enter a service name to identify this Internet connection here.

Reconnect Mode: Use the radio buttons to specify the reconnect mode. The user can specify a custom schedule or specify the **On Demand**, or **Manual** option. To specify a custom schedule, use the drop-down menu to select one of the schedules that has been defined in the Schedules page.

INTERNET CONNECTION TYPE

Choose the mode to be used by the router to connect to the Internet.

My Internet Connection is : PPPoE (Username / Password) ▾

PPPOE INTERNET CONNECTION TYPE :

Enter the information provided by your Internet Service Provider (ISP).

Address Mode : Dynamic IP Static IP

IP Address :

Username :

Password :

Verify Password :

Service Name : (optional)

Reconnect Mode : Always on ▾ On demand Manual

Maximum Idle Time : (minutes, 0=infinite)

DNS Mode : Receive DNS from ISP Enter DNS Manually

Primary DNS Server :

Secondary DNS Server : (optional)

MTU :

MAC Address :

To create a new schedule, click the **New Schedule** button to open the Schedules page. Schedules will be discussed later.

Maximum Idle Time: Enter a maximum idle time during which the Internet connection is maintained during inactivity.

DNS Mode: This option allow the router to obtain the DNS IP addresses from the ISP, when **Receive DNS from ISP** is selected, or allows the user to enter DNS IP address manually, when **Enter DNS Manually** is selected.

Primary DNS Server: Enter the Primary DNS IP address used here.

Secondary DNS Server: Enter the Secondary DNS IP address used here. This field is normally optional. Only one DNS address is required for a functional Internet connection, but using a second DNS address provides more stability.

MTU: Maximum Transmission Unit - you may need to change the MTU for optimal performance with your specific ISP. 1492 is the default MTU.

MAC Address: The default MAC Address is set to the Internet port's physical interface MAC address on the Broadband Router. It is not recommended that you change the default MAC address unless required by your ISP. You can use the **Clone Your PC's MAC Address** button to replace the Internet port's MAC address with the MAC address of your Ethernet card.

Internet Setup

PPTP

Choose PPTP (Point-to-Point-Tunneling Protocol) if your ISP uses a PPTP connection. Your ISP will provide you with a username and password. This option is typically used for DSL services.

My Internet Connection: Select **PPTP (Username/Password)** from the drop-down menu.

Address Mode: Here the user can specify whether this Internet connection requires the use of a **Dynamic** or **Static IP** address. PPTP usually requires a Dynamic IP configuration.

PPTP IP Address: Enter the PPTP IP address used here. This option is only available if Static IP is selected.

PPTP Subnet Mask: Enter the PPTP Subnet Mask used here.

PPTP Gateway IP Address: Enter the PPTP Gateway IP address used here.

PPTP Server IP Address: Enter the PPTP Server IP address used here. This is normally the same as the PPTP Gateway IP address.

Username: Enter the PPTP username used here.

Password: Enter the PPTP password used here.

Verify Password: Re-enter the PPTP password used here.

Reconnect Mode: Use the radio buttons to specify the reconnect mode. The user can specify a custom schedule or specify the **On Demand**, or **Manual** option. To specify a custom schedule, use the drop-down menu to select one of the schedules that has been defined in the Schedules page. To create a new schedule, click the New Schedule button to open the Schedules page. Schedules will be discussed later.

Maximum Idle Time: Enter a maximum idle time during which the Internet connection is maintained during inactivity. To disable this feature, enable Auto-reconnect.

INTERNET CONNECTION TYPE

Choose the mode to be used by the router to connect to the Internet.

My Internet Connection is : PPTP (Username / Password) ▼

PPTP INTERNET CONNECTION TYPE :

Enter the information provided by your Internet Service Provider (ISP).

Address Mode : Dynamic IP Static IP

PPTP IP Address :

PPTP Subnet Mask :

PPTP Gateway IP Address :

PPTP Server IP Address :

Username :

Password :

Verify Password :

Reconnect Mode : Always on ▼ New Schedule
 On demand Manual

Maximum Idle Time : (minutes, 0=infinite)

Primary DNS Server :

Secondary DNS Server : (optional)

MTU : 1400

MAC Address :

Primary DNS Server: Enter the Primary DNS IP address used here.

Secondary DNS Server: Enter the Secondary DNS IP address used here. This field is normally optional. Only one DNS address is required for a functional Internet connection, but using a second DNS address provides more stability.

MTU: Maximum Transmission Unit - you may need to change the MTU for optimal performance with your specific ISP. 1400 is the default MTU.

MAC Address: The default MAC Address is set to the Internet port's physical interface MAC address on the Broadband Router. It is not recommended that you change the default MAC address unless required by your ISP. You can use the **Clone Your PC's MAC Address** button to replace the Internet port's MAC address with the MAC address of your Ethernet card.

Internet Setup

L2TP

Choose L2TP (Layer 2 Tunneling Protocol) if your ISP uses a L2TP connection. Your ISP will provide you with a username and password. This option is typically used for DSL services.

My Internet Connection: Select **L2TP (Username/Password)** from the drop-down menu.

Address Mode: Here the user can specify whether this Internet connection requires the use of a Dynamic or Static IP address. L2TP usually requires a Dynamic IP configuration.

L2TP IP Address: Enter the L2TP IP address used here. This option is only available if Static IP is selected.

L2TP Subnet Mask: Enter the L2TP Subnet Mask used here.

L2TP Gateway IP Address: Enter the L2TP Gateway IP address used here.

Address:

L2TP Server IP Address: Enter the L2TP Server IP address used here. This is

Address: normally the same as the L2TP Gateway IP address.

Username: Enter the L2TP username used here.

Password: Enter the L2TP password used here.

Verify Password: Re-enter the L2TP password used here.

Reconnect Mode: Use the radio buttons to specify the reconnect mode. The user can specify a custom schedule or specify the **On Demand**, or **Manual** option. To specify a custom schedule, use the drop-down menu to select one of the schedules that has been defined in the Schedules page. To create a new schedule, click the New Schedule button to open the Schedules page. Schedules will be discussed later.

INTERNET CONNECTION TYPE

Choose the mode to be used by the router to connect to the Internet.

My Internet Connection is : ▼

L2TP INTERNET CONNECTION TYPE :

Enter the information provided by your Internet Service Provider (ISP).

Address Mode : Dynamic IP Static IP

L2TP IP Address :

L2TP Subnet Mask :

L2TP Gateway IP Address :

L2TP Server IP Address :

Username :

Password :

Verify Password :

Reconnect Mode : Always on New Schedule On demand Manual

Maximum Idle Time : (minutes, 0=infinite)

Primary DNS Server :

Secondary DNS Server : (optional)

MTU :

MAC Address :

Maximum Idle Time: Enter a maximum idle time during which the Internet connection is maintained during inactivity. To disable this feature, enable Auto-reconnect.

Primary DNS Server: Enter the Primary DNS IP address used here.

Secondary DNS Server: Enter the Secondary DNS IP address used here. This field is normally optional. Only one DNS address is required for a functional Internet connection, but using a second DNS address provides more stability.

MTU: Maximum Transmission Unit - you may need to change the MTU for optimal performance with your specific ISP. 1400 is the default MTU.

MAC Address: The default MAC Address is set to the Internet port's physical interface MAC address on the Broadband Router. It is not recommended that you change the default MAC address unless required by your ISP. You can use the **Clone Your PC's MAC Address** button to replace the Internet port's MAC address with the MAC address of your Ethernet card.

Internet Setup

DS-Lite

Another Internet Connection type is DS-Lite.

DS-Lite is an IPv6 connection type. After selecting DS-Lite, the following parameters will be available for configuration:

DS-Lite Configuration: Select the **DS-Lite DHCPv6 Option** to let the router allocate the AFTR IPv6 address automatically. Select the **Manual Configuration** to enter the AFTR IPv6 address in manually.

AFTR IPv6 Address: After selecting the Manual Configuration option above, the user can enter the AFTR IPv6 address used here.

B4 IPv4 Address: Enter the B4 IPv4 address value used here.

WAN IPv6 Address: Once connected, the WAN IPv6 address will be displayed here.

IPv6 WAN Default Gateway Once connected, the IPv6 WAN Default Gateway address will be displayed here.

Click on the **Save Settings** button to accept the changes made.

Click on the **Don't Save Settings** button to discard the changes made.

INTERNET CONNECTION TYPE

Choose the mode to be used by the router to connect to the Internet.

My Internet Connection is :

AFTR ADDRESS INTERNET CONNECTION TYPE :

Enter the AFTR address information provided by your Internet Service Provider (ISP).

DS-Lite Configuration : DS-Lite DHCPv6 Option Manual Configuration

AFTR IPv6 Address :

B4 IPv4 Address : 192.0.0. (optional)

WAN IPv6 Address :

IPv6 WAN Default Gateway :

Wireless connection setup wizard

On this page the user can configure the Wireless settings for this device. There are 3 ways to configure Wireless using this router. Firstly, the user can choose to make use for the quick and easy **Wireless Connection Setup Wizard**. Secondly, the user can choose to make use Wi-Fi Protected Setup. Lastly, the user can configure the Wireless settings manually.

Wireless Settings: Wireless Connection Setup Wizard

The Wireless Connection Setup Wizard is specially designed to assist basic network users with a simple, step-by-step set of instructions to configure the wireless settings of this router. It is highly recommended to customized the wireless network settings to fit into your environment and to add higher security.

To initiate the **Wireless Connection Setup Wizard** click on the Wireless Connection Setup Wizard button.

Step 1: In this step, the user must enter a custom Wireless Network Name or SSID. Enter the new **Network Name (SSID)** in the appropriate space provided.

There are separate spaces provided for a **2.4GHz** Network Name and a **5GHz** Network Name.

Secondly the user can choose between two wireless security wizard configurations. The user can select '**Automatically assign a network key**', by which the router will automatically generate a WPA/WPA2 pre-shared key using the TKIP and AES encryption methods; or the user can select '**Manually assign a network key**', by which the user will be prompt to manually enter a WPA/WPA2 pre-shared key using the TKIP and AES encryption methods.

Click on the **Prev** button to return to the previous page. Click on the **Next** button to continue to the next page. Click on the **Cancel** button to discard the changes made and return to the main wireless page.

The screenshot displays the 'WIRELESS SETTINGS' page. At the top, an orange header reads 'WIRELESS SETTINGS'. Below it, a grey box contains introductory text: 'The following Web-based wizards are designed to assist you in your wireless network setup and wireless device connection. Before launching these wizards, please make sure you have followed all steps outlined in the Quick Installation Guide included in the package.' The main section is titled 'WIRELESS NETWORK SETUP WIZARD' in a dark header. It states: 'This wizard is designed to assist you in your wireless network setup. It will guide you through step-by-step instructions on how to set up your wireless network and how to make it secure.' A button labeled 'Wireless Connection Setup Wizard' is centered. A 'Note' follows: 'Some changes made using this Setup Wizard may require you to change some settings on your wireless client adapters so they can still connect to the D-Link Router.' The next section is 'STEP 1: WELCOME TO THE D-LINK WIRELESS SECURITY SETUP WIZARD'. It prompts the user to 'Give your network a name, using up to 32 characters.' There are two input fields: 'Network Name (SSID) 2.4GHz' with the value 'dlink-ecb8' and 'Network Name (SSID) 5GHz' with the value 'dlink-media-ecba'. Two radio button options are shown: 'Automatically assign a network key (Recommended)' (selected) and 'Manually assign a network key'. The first option includes a sub-note: 'To prevent outsiders from accessing your network, the router will automatically assign a security (also called WEP or WPA key) to your network.' The second option includes a sub-note: 'Use this options if you prefer to create our own key.' A 'Note' at the bottom states: 'All D-Link wireless adapters currently support WPA.' At the very bottom, there are four buttons: 'Prev', 'Next', 'Cancel', and 'Save'.

Step 2: This step will only be available if the user selected 'Manually assign a network key' in the previous step. Here the user can manually enter the WPA/WPA2 pre-shared key in the **Wireless Security Password** space provided. The key entered must be between 8 and 63 characters long. Remember, this key will be used when wireless clients want to connect to this device. So please remember this key to prevent future troubleshooting.

If you want to use the same Wireless Security Password for both 2.4GHz and 5GHz bands, **tick** the option provided. If not selected, you need to input two separate Wireless Security Passwords for each individual Wireless band.

Click on the **Prev** button to return to the previous page. Click on the **Next** button to continue to the next page. Click on the **Cancel** button to discard the changes made and return to the main wireless page.

Setup Complete: On this page the user can view the configuration made and verify whether they are correct.

Click on the **Prev** button to return to the previous page. Click on the **Cancel** button to discard the changes made and return to the main wireless page. Click on the **Save** button to accept the changes made.

STEP 2: SET YOUR WIRELESS SECURITY PASSWORD

You have selected your security level - you will need to set a wireless security password.

The WPA (Wi-Fi Protected Access) key must meet one of following guidelines:

- Between 8 and 63 characters (A longer WPA key is more secure than a short one)
- Exactly 64 characters using 0-9 and A-F

Use the same Wireless Security Password on both 2.4GHz and 5GHz band

2.4Ghz Wireless Security Password :

5Ghz Wireless Security Password :

Note: You will need to enter the same password as keys in this step into your wireless clients in order to enable proper wireless communication.

SETUP COMPLETE!

Below is a detailed summary of your wireless security settings. Please print this page out, or write the information on a piece of paper, so you can configure the correct settings on your wireless client adapters.

Wireless Band : 2.4GHz Band

Wireless Network Name (SSID) : dlink-ecb8

Security Mode : Auto (WPA or WPA2) - Personal

Cipher Type : TKIP and AES

Pre-Shared Key : 2c2dbdbe54

Wireless Band : 5GHz Band

Wireless Network Name (SSID) : dlink-media-ecba

Security Mode : Auto (WPA or WPA2) - Personal

Cipher Type : TKIP and AES

Pre-Shared Key : 2c2dbdbe54

After click the **Save** button the device will save the settings made and return to the main wireless page.

End of Wizard.



Wi-Fi Protected Setup Wizard

Wireless Settings: Wi-Fi Protected Setup Wizard

If your Wireless Clients support the WPS connection method, this Wi-Fi Protected Setup Wizard can be used to initiate a wireless connection between this device and Wireless clients with a simple click of the WPS button. The Wi-Fi Protected Setup Wizard is specially designed to assist basic network users with a simple, step-by-step set of instructions to connect wireless clients to this router using the WPS method.

To initiate the Wi-Fi Protected Setup Wizard click on the **Add Wireless Device with WPS** button.

Step 1: In this step the user have two options to choose from. You can choose **Auto** if the wireless client supports WPS, or **Manual** if the wireless client does not support WPS.

Click on the **Prev** button to return to the previous page. Click on the **Next** button to continue to the next page. Click on the **Cancel** button to discard the changes made and return to the main wireless page.

Step 2: After selecting **Auto**, the following page will appear. There are two ways to add a wireless device, that supports WPS. Firstly, there is the Personal Identification Number (**PIN**) method. Using this method will prompt the user to enter a PIN code. This PIN code should be identical on the wireless client. Secondly, there is the Push Button Configuration (**PBC**) method. Using this method will allow the wireless client to connect to this device by similarly pressing the PBC button on it.

Click on the **Prev** button to return to the previous page. Click on the **Next** button to continue to the next page. Click on the **Cancel** button to discard the changes made and return to the main wireless page.

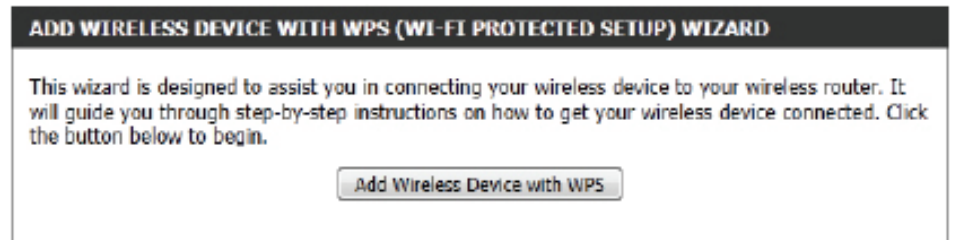

ADD WIRELESS DEVICE WITH WPS (WI-FI PROTECTED SETUP) WIZARD

This wizard is designed to assist you in connecting your wireless device to your wireless router. It will guide you through step-by-step instructions on how to get your wireless device connected. Click the button below to begin.

Add Wireless Device with WPS



STEP 1: SELECT CONFIGURATION METHOD FOR YOUR WIRELESS NETWORK

Please select one of following configuration methods and click next to continue.

Auto Select this option if your wireless device supports WPS (Wi-Fi Protected Setup)

Manual Select this option will display the current wireless settings for you to configure the wireless device manually

Prev **Next** **Cancel** **Connect**

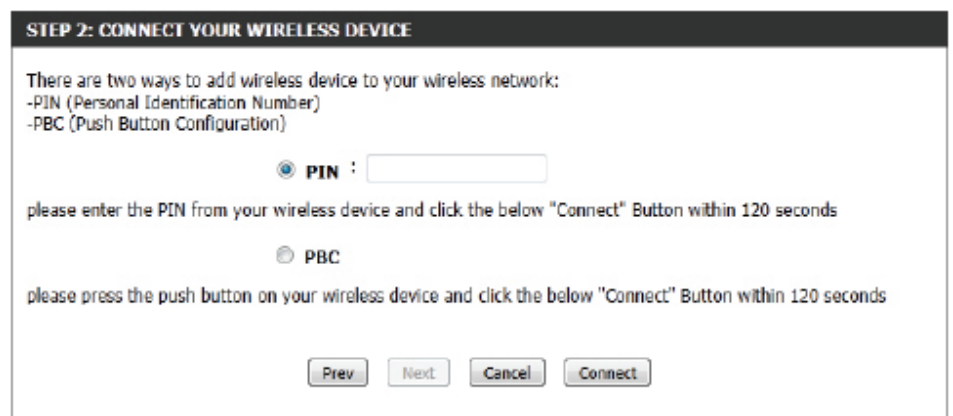

STEP 2: CONNECT YOUR WIRELESS DEVICE

There are two ways to add wireless device to your wireless network:
-PIN (Personal Identification Number)
-PBC (Push Button Configuration)

PIN :

please enter the PIN from your wireless device and click the below "Connect" Button within 120 seconds

PBC

please press the push button on your wireless device and click the below "Connect" Button within 120 seconds

Prev **Next** **Cancel** **Connect**

Step 2: After selecting Manual, the following page will appear. On this page to user can view the wireless configuration of this router. The wireless clients should configure their wireless settings to be identical to the settings displayed on this page for a successful connection. This option is for wireless clients that can't use the WPS method to connect to this device.

Click on the **Prev** button to return to the previous page. Click on the **Next** button to continue to the next page. Click on the **Cancel** button to discard the changes made and return to the main wireless page. Click on the **Wireless Status** button to navigate to the Status > Wireless page to view what wireless client are connected to this device.

End of Wizard.

STEP 2: CONNECT YOUR WIRELESS DEVICE

Below is a detailed summary of your wireless security settings. Please print this page out, or write the information on a piece of paper, so you can configure the correct settings on your wireless client adapters.

2.4 Ghz Frequency
SSID: dlink-ecb8
Security Mode: Auto (WPA or WPA2) - Personal
Cipher Type: TKIP and AES
Pre-shared Key: 24key24key

5 Ghz Frequency
SSID: dlink-media-ecba
Security Mode: Auto (WPA or WPA2) - Personal
Cipher Type: TKIP and AES
Pre-shared Key: 50key50key

Manual wireless network setup

Wireless Settings: Manual Wireless Network Setup

The manual wireless network setup option allows users to configure the wireless settings of this device manually. This option is for the more advanced user and includes all parameters that can be configured for wireless connectivity.

To initiate the Manual Wireless Setup page, click on the **Manual Wireless Connection Setup** button.

On this page the user can configure all the parameters related to the wireless connectivity of this router.

MANUAL WIRELESS NETWORK SETUP

If your wireless network is already set up with Wi-Fi Protected Setup, manual configuration of the wireless network will destroy the existing wireless network. If you would like to configure the wireless settings of your new D-Link Systems Router manually, then click on the Manual Wireless Network Setup button below.

WIRELESS NETWORK

Use this section to configure the wireless settings for your D-Link router. Please note that changes made in this section may also need to be duplicated on your wireless client.

To protect your privacy you can configure wireless security features. This device supports three wireless security modes including: WEP, WPA and WPA2.

The following parameters will be available for configuration:

Wireless Band: Displays the wireless band being configured. In this option we find that the following parameters will be regarding the 2.4GHz band.

Enable Wireless: Check the box to enable the wireless function. If you do not want to use wireless, uncheck the box to disable all the wireless functions. Select the time frame that you would like your wireless network enabled. The schedule may be set to Always. Any schedule you create will be available in the drop-down menu. Click New Schedule to create a new schedule.

WIRELESS NETWORK SETTINGS

Wireless Band : 2.4GHz Band

Enable Wireless : Always

Wireless Network Name : dlink-ecb8 (Also called the SSID)

802.11 Mode : Mixed 802.11n, 802.11g and 802.11b

Enable Auto Channel Scan :

Wireless Channel : 2.412 GHz - CH 1

Transmission Rate : Best (automatic) (Mbit/s)

Channel Width : 20/40 MHz(Auto)

Visibility Status : Visible Invisible

Wireless Network Name: The Service Set Identifier (SSID) is the name of your wireless network. Create a name using up to 32 characters. The SSID is case-sensitive. Enable Auto Channel

802.11 Mode: Here the user can manually select the preferred frequency band to use for this wireless network.

Enable Auto Channel Scan: The auto channel selection setting can be selected to allow this device to choose the channel with the least amount of interference.

Wireless Channel: By default the channel is set to 1. The Channel can be changed to fit the channel setting for an existing wireless network or to customize the wireless network. If you enable Auto Channel Selection, this option will be greyed out.

Transmission Rate: Select the transmit rate. It is strongly suggested to select Best (Automatic) for best performance.

Channel Width: When using the 802.11n frequency band, the user have an option to choose between a 20MHz or 20/40MHz bandwidth.

Visibility Status: The Invisible option allows you to hide your wireless network. When this option is set to Visible, your wireless network name is broadcasted to anyone within the range of your signal. If you are not using encryption then they could connect to your network. When Invisible mode is enabled, you must enter the Wireless Network Name (SSID) on the client manually to connect to the network.

By default the wireless security of this router will be disabled. In this next option the user can enable or disable wireless security for the frequency band 2.4GHz. There are two types of encryption that can be used. WEP or WPA/WPA2.

Wireless Security Mode: WEP

Wired Equivalent Privacy (WEP) is the most basic form of encryption that can be used for wireless networks. Even though it is known as a 'weak' security method, it is better than no security at all. Older wireless adapters sometimes only support WEP encryption and thus we still find this encryption method used today.

The following parameters will be available for configuration:

WEP Key Length: Here the user can specify to either use a 64Bit or a 128Bit encrypted key.

Authentication: Authentication is a process by which the router verifies the identity of a network device that is attempting to join the wireless network. There are two types of authentication for this device when using WEP. **Open System** allows all wireless devices to communicate with the router before they are required to provide the encryption key needed to gain access to the network. **Shared Key** requires any wireless device attempting to communicate with the router to provide the encryption key needed to access the network before they are allowed to communicate with the router.

WEP Key 1: Enter the WEP key used here. For 64-bit keys you must enter 10 hex digits into each key box. For 128-bit keys you must enter 26 hex digits into each key box. A hex digit is either a number from 0 to 9 or a letter from A to F. You may also enter any text string into a WEP key box, in which case it will be converted into a hexadecimal key using the ASCII values of the characters. A maximum of 5 text characters can be entered for 64-bit keys, and a maximum of 13 characters for 128-bit keys.



WIRELESS SECURITY MODE

Security Mode : None



WIRELESS SECURITY MODE

Security Mode : WEP

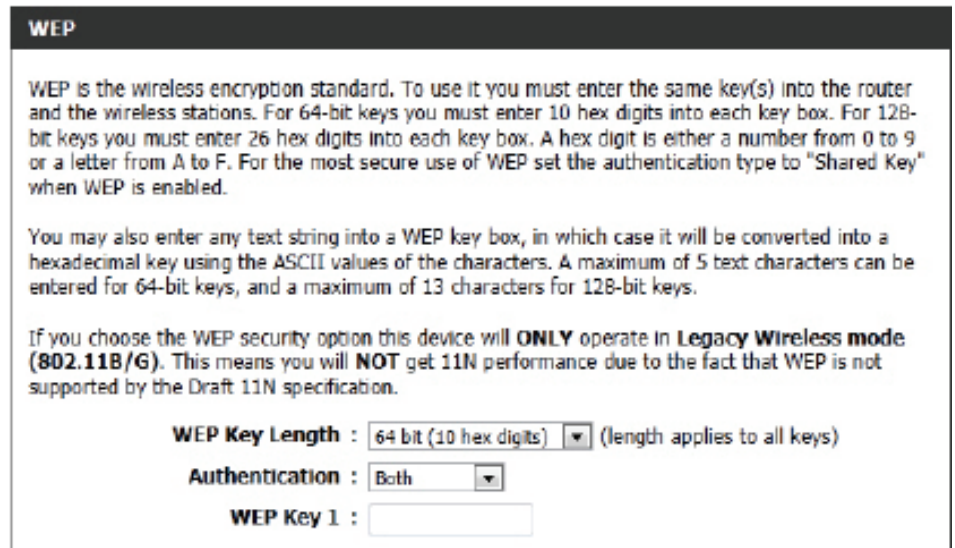

WEP

WEP is the wireless encryption standard. To use it you must enter the same key(s) into the router and the wireless stations. For 64-bit keys you must enter 10 hex digits into each key box. For 128-bit keys you must enter 26 hex digits into each key box. A hex digit is either a number from 0 to 9 or a letter from A to F. For the most secure use of WEP set the authentication type to "Shared Key" when WEP is enabled.

You may also enter any text string into a WEP key box, in which case it will be converted into a hexadecimal key using the ASCII values of the characters. A maximum of 5 text characters can be entered for 64-bit keys, and a maximum of 13 characters for 128-bit keys.

If you choose the WEP security option this device will **ONLY** operate in **Legacy Wireless mode (802.11B/G)**. This means you will **NOT** get 11N performance due to the fact that WEP is not supported by the Draft 11N specification.

WEP Key Length : 64 bit (10 hex digits) (length applies to all keys)

Authentication : Both

WEP Key 1 :

Wireless Security Mode: WPA-Personal

Wi-Fi Protected Access (WPA) is the most advanced and up to date wireless encryption method used today. This is the recommended wireless security option. WPA supports two authentication frameworks. Personal (PSK) and Enterprise (EAP). Personal requires only the use of a pass-phrase (Shared Secret) for security.

The following parameters will be available for configuration:

WPA Mode: WPA is the older standard; select this option if the clients that will be used with the router only support the older standard. WPA2 is the newer implementation of the stronger IEEE 802.11i security standard. With the “WPA2” option, the router tries WPA2 first, but falls back to WPA if the client only supports WPA. With the “WPA2 Only” option, the router associates only with clients that also support WPA2 security.

Cipher Type: Select the appropriate cipher type to use here. Options to choose from are Temporal Key Integrity Protocol (TKIP), Advanced Encryption Standard (AES), and Both (TKIP and AES).

Group Key Update Interval: Enter the amount of time before the group key used for broadcast and multicast data is changed.

Pre-Shared Key: Enter the shared secret used here. This secret phrase needs to be the same on all of the wireless clients for them to be able to connect to the wireless network successfully.

The screenshot displays the configuration interface for wireless security. It is divided into three main sections: WIRELESS SECURITY MODE, WPA, and PRE-SHARED KEY.

- WIRELESS SECURITY MODE:** A dropdown menu is set to "WPA-Personal".
- WPA:** Contains explanatory text about WPA and WPA2 modes. Below the text are three configuration fields:
 - WPA Mode:** A dropdown menu set to "Auto(WPA or WPA2)".
 - Cipher Type:** A dropdown menu set to "TKIP and AES".
 - Group Key Update Interval:** A text input field containing "3600" followed by "(seconds)".
- PRE-SHARED KEY:** Contains instructions to enter an 8- to 63-character alphanumeric pass-phrase. Below the instructions is a text input field for the "Pre-Shared Key".

Wireless Security Mode: WPA-Personal

Wi-Fi Protected Access (WPA) is the most advanced and up to date wireless encryption method used today. This is the recommended wireless security option. WPA supports two authentication frameworks. Personal (PSK) and Enterprise (EAP). Personal requires only the use of a passphrase (Shared Secret) for security.

The following parameters will be available for configuration:

WPA Mode: WPA is the older standard; select this option if the clients that will be used with the router only support the older standard. WPA2 is the newer implementation of the stronger IEEE 802.11i security standard. With the “WPA2” option, the router tries WPA2 first, but falls back to WPA if the client only supports WPA. With the “WPA2 Only” option, the router associates only with clients that also support WPA2 security.

Cipher Type: Select the appropriate cipher type to use here. Options to choose from are Temporal Key Integrity Protocol (TKIP), Advanced Encryption Standard (AES), and Both (TKIP and AES).

Group Key Update Interval: Enter the amount of time before the group key used for broadcast and multicast data is changed.

RADIUS Server IP Address: When the user chooses to use the EAP authentication framework, the RADIUS server’s IP address can be entered here.

RADIUS Server Port: When the user chooses to use the EAP authentication framework, the RADIUS server’s port number can be entered here.

RADIUS Server Shared Secret: Enter the shared secret used here. This secret phrase needs to be the same on all of the wireless clients for them to be able to connect to the wireless network successfully.

The screenshot shows the 'WIRELESS SECURITY MODE' configuration page. At the top, 'Security Mode' is set to 'WPA-Enterprise'. Below this is the 'WPA' section, which includes a detailed explanation of WPA and WPA2 modes. It states that WPA2 Only mode uses AES(CCMP) cipher and is the most secure, while WPA Only mode uses TKIP cipher. A note suggests using WPA2 Only for better performance. The 'WPA Mode' is set to 'Auto(WPA or WPA2)', 'Cipher Type' is 'TKIP and AES', and 'Group Key Update Interval' is '3600 (seconds)'. The 'EAP (802.1X)' section is also visible, with fields for 'RADIUS server IP Address', 'RADIUS server Port' (set to 1812), and 'RADIUS server Shared Secret'. An 'Advanced >>' button is located at the bottom of the EAP section.

The following parameters will be available for configuration:

Wireless Band: Displays the wireless band being configured. In this option we find that the following parameters will be regarding the 5GHz band.

Enable Wireless: Check the box to enable the wireless function. If you do not want to use wireless, uncheck the box to disable all the wireless functions. Select the time frame that you would like your wireless network enabled. The schedule may be set to Always. Any schedule you create will be available in the drop-down menu. Click New Schedule to create a new schedule.

WIRELESS NETWORK SETTINGS

Wireless Band : 5GHz Band

Enable Wireless : Always

Wireless Network Name : dlink-media-ecba (Also called the SSID)

802.11 Mode : Mixed 802.11ac

Enable Auto Channel Scan :

Wireless Channel : 5.180 GHz - CH 36

Transmission Rate : Best (automatic) (Mbit/s)

Channel Width : 20/40/80 MHz (Auto)

Visibility Status : Visible Invisible

Wireless Network Name: The Service Set Identifier (SSID) is the name of your wireless network. Create a name using up to 32 characters. The SSID is case-sensitive. Enable Auto Channel

802.11 Mode: Here the user can manually select the preferred frequency band to use for this wireless network.

Enable Auto Channel Scan: The auto channel selection setting can be selected to allow this device to choose the channel with the least amount of interference.

Wireless Channel: By default the channel is set to 36. The Channel can be changed to fit the channel setting for an existing wireless network or to customize the wireless network. If you enable Auto Channel Selection, this option will be greyed out.

Transmission Rate: Select the transmit rate. It is strongly suggested to select Best (Automatic) for best performance.

Channel Width: When using the 802.11n frequency band, the user have an option to choose between a 20 MHz, 20/40 MHz, or 20/40/80 MHz bandwidth.

Visibility Status: The Invisible option allows you to hide your wireless network. When this option is set to Visible, your wireless network name is broadcasted to anyone within the range of your signal. If you are not using encryption then they could connect to your network. When Invisible mode is enabled, you must enter the Wireless Network Name (SSID) on the client manually to connect to the network.

By default the wireless security of this router will be disabled. In this next option the user can enable or disable wireless security for the frequency band 2.4GHz. There are two types of encryption that can be used. WEP or WPA/WPA2.

Wireless Security Mode: WEP

Wired Equivalent Privacy (WEP) is the most basic form of encryption that can be used for wireless networks. Even though it is known as a 'weak' security method, it is better than no security at all. Older wireless adapters sometimes only support WEP encryption and thus we still find this encryption method used today.

The following parameters will be available for configuration:

WEP Key Length: Here the user can specify to either use a 64Bit or a 128Bit encrypted key.

Authentication: Authentication is a process by which the router verifies the identity of a network device that is attempting to join the wireless network. There are two types of authentication for this device when using WEP. **Open System** allows all wireless devices to communicate with the router before they are required to provide the encryption key needed to gain access to the network. **Shared Key** requires any wireless device attempting to communicate with the router to provide the encryption key needed to access the network before they are allowed to communicate with the router.

WEP Key 1: Enter the WEP key used here. For 64-bit keys you must enter 10 hex digits into each key box. For 128-bit keys you must enter 26 hex digits into each key box. A hex digit is either a number from 0 to 9 or a letter from A to F. You may also enter any text string into a WEP key box, in which case it will be converted into a hexadecimal key using the ASCII values of the characters. A maximum of 5 text characters can be entered for 64-bit keys, and a maximum of 13 characters for 128-bit keys.

WIRELESS SECURITY MODE

Security Mode :

WIRELESS SECURITY MODE

Security Mode :

WEP

WEP is the wireless encryption standard. To use it you must enter the same key(s) into the router and the wireless stations. For 64-bit keys you must enter 10 hex digits into each key box. For 128-bit keys you must enter 26 hex digits into each key box. A hex digit is either a number from 0 to 9 or a letter from A to F. For the most secure use of WEP set the authentication type to "Shared Key" when WEP is enabled.

You may also enter any text string into a WEP key box, in which case it will be converted into a hexadecimal key using the ASCII values of the characters. A maximum of 5 text characters can be entered for 64-bit keys, and a maximum of 13 characters for 128-bit keys.

If you choose the WEP security option this device will **ONLY** operate in **Legacy Wireless mode (802.11B/G)**. This means you will **NOT** get 11N performance due to the fact that WEP is not supported by the Draft 11N specification.

WEP Key Length : (length applies to all keys)

Authentication :

WEP Key 1 :

Wireless Security Mode: WPA-Personal

Wi-Fi Protected Access (WPA) is the most advanced and up to date wireless encryption method used today. This is the recommended wireless security option. WPA supports two authentication frameworks. Personal (PSK) and Enterprise (EAP).

The following parameters will be available for configuration:

WPA Mode: WPA is the older standard; select this option if the clients that will be used with the router only support the older standard. WPA2 is the newer implementation of the stronger IEEE 802.11i security standard. With the “WPA2” option, the router tries WPA2 first, but falls back to WPA if the client only supports WPA. With the “WPA2 Only” option, the router associates only with clients that also support WPA2 security.

Cipher Type: Select the appropriate cipher type to use here. Options to choose from are Temporal Key Integrity Protocol (TKIP), Advanced Encryption Standard (AES), and Both (TKIP and AES).

Group Key Update Interval: Enter the amount of time before the group key used for broadcast and multicast data is changed.

Pre-Shared Key: Enter the shared secret used here. This secret phrase needs to be the same on all of the wireless clients for them to be able to connect to the wireless network successfully.

The screenshot shows the configuration page for Wireless Security Mode. It is divided into three sections: WIRELESS SECURITY MODE, WPA, and PRE-SHARED KEY.

- WIRELESS SECURITY MODE:** The Security Mode is set to WPA-Personal.
- WPA:** A detailed explanation of WPA and WPA2 modes is provided. Below the text, the WPA Mode is set to Auto(WPA or WPA2), the Cipher Type is set to TKIP and AES, and the Group Key Update Interval is set to 3600 seconds.
- PRE-SHARED KEY:** A prompt asks the user to enter an 8- to 63-character alphanumeric pass-phrase. The Pre-Shared Key field is currently empty.

Wireless Security Mode: WPA-Enterprise

Wi-Fi Protected Access (WPA) is the most advanced and up to date wireless encryption method used today. This is the recommended wireless security option. WPA supports two authentication frameworks. Personal (PSK) and Enterprise (EAP).

The following parameters will be available for configuration:

WPA Mode: WPA is the older standard; select this option if the clients that will be used with the router only support the older standard. WPA2 is the newer implementation of the stronger IEEE 802.11i security standard. With the “WPA2” option, the router tries WPA2 first, but falls back to WPA if the client only supports WPA. With the “WPA2 Only” option, the router associates only with clients that also support WPA2 security.

Cipher Type: Select the appropriate cipher type to use here. Options to choose from are Temporal Key Integrity Protocol (TKIP), Advanced Encryption Standard (AES), and Both (TKIP and AES).

Group Key Update Interval: Enter the amount of time before the group key used for broadcast and multicast data is changed.

RADIUS Server IP Address: When the user chooses to use the EAP authentication framework, the RADIUS server’s IP address can be entered here.

RADIUS Server Port: When the user chooses to use the EAP authentication framework, the RADIUS server’s port number can be entered here.

RADIUS Server Shared Secret: Enter the shared secret used here. This secret phrase needs to be the same on all of the wireless clients for them to be able to connect to the wireless network successfully.

The screenshot shows the 'WIRELESS SECURITY MODE' configuration page. At the top, 'Security Mode' is set to 'WPA-Enterprise'. Below this is the 'WPA' section, which includes a detailed explanation of WPA and WPA2 modes, a 'WPA Mode' dropdown set to 'Auto(WPA or WPA2)', a 'Cipher Type' dropdown set to 'TKIP and AES', and a 'Group Key Update Interval' field set to '3600' seconds. The 'EAP (802.1X)' section is also visible, with a note that it is used for authentication via a remote RADIUS server. It contains fields for 'RADIUS server IP Address', 'RADIUS server Port' (set to 1812), and 'RADIUS server Shared Secret'. An 'Advanced >>' button is located at the bottom of the EAP section.

Bridge Mode

After enabling the **Bridge Mode**, on the **Internet** page, this page will change to what we see here. On this page we can configure the wireless network settings to scan for available wireless networks, using the Wireless Bridge functionality and then connect to them.

Bridge Mode allows wireless and non-wireless network devices to connect to an existing DIR-865L, in Router Mode, through the means of another DIR-865L, in Bridge Mode.

This will allow wireless and non-wireless network appliances to connect to the DIR-865L, in Router Mode, at the **maximum wireless speed** available for 802.11ac, by simple connecting to the DIR-865L, in Bridge Mode, with an Ethernet cable.

There can be multiple DIR-865L units, in Bridge Mode, that can connect to the central DIR-865L, in Router Mode. This gives users extra flexibility and compatibility.

Refer to "[Internet \(Manual\)](#)" on page 34 on how to enable **Bridge Mode**.

The following parameters will be available for configuration:

Wireless Band: This field will display the wireless band used by this device. Click the **Site Survey** button to initiate a search and selection of available wireless access point in the area.

Enable Wireless: Tick this option to enable the wireless functionality of the device.

Wireless Network Name: After selecting a wireless connection, using the **Site Survey** option, the wireless network name will automatically be entered in this field. However, we can also manually enter the wireless network name (SSID) used here.

Wireless Band: Here we can select the Wireless Band used. Options to choose from are 2.4 GHz and 5 GHz.

Band Width: This field will display the current bandwidth used for the wireless connection.

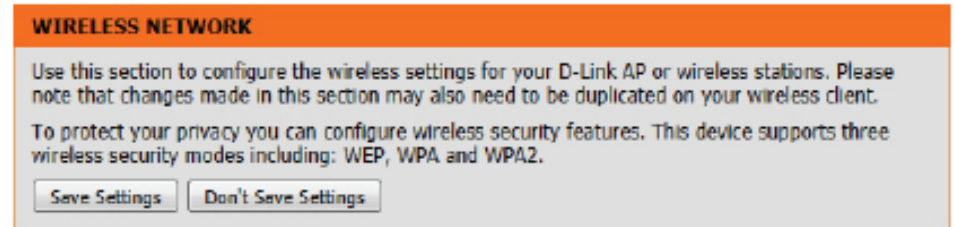

* When the device operate in Bridge Mode, please let WAN port empty

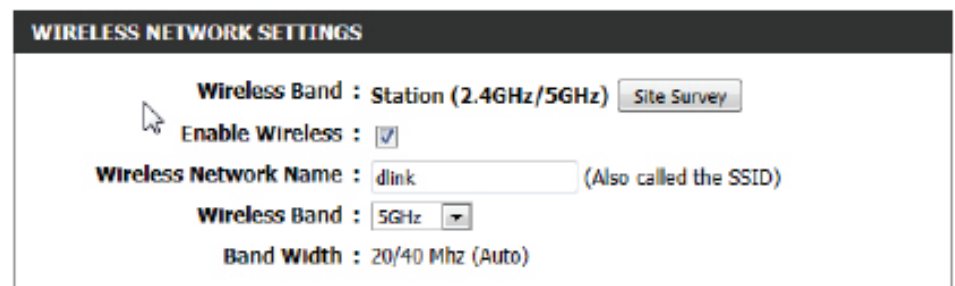

After clicking the **Site Survey** button, the following window will appear.

Select the appropriate wireless network and click the **Connect** button to use it.

Click the **Exit** button to return to the Wireless Settings page,

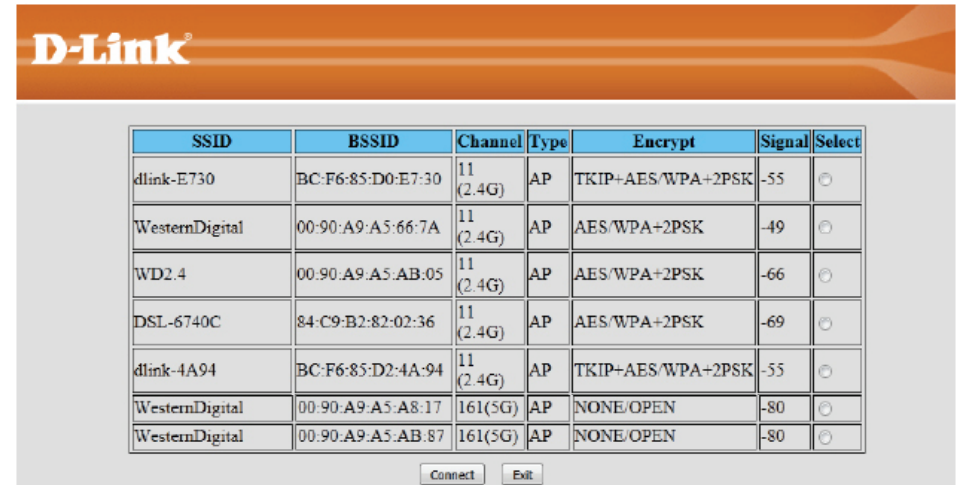

By default the wireless security of this router will be disabled. In this next option the user can enable or disable wireless security for the frequency band 2.4GHz. There are two types of encryption that can be used. WEP or WPA/WPA2.



Wireless Security Mode: Enable WEP Wireless Security (basic)

Wired Equivalent Privacy (WEP) is the most basic form of encryption that can be used for wireless networks. Even though it is known as a 'weak' security method, it is better than no security at all. Older wireless adapter sometimes only supports WEP encryption and thus we still find this encryption method used today.

The following parameters will be available for configuration:

Authentication: Authentication is a process by which the router verifies the identity of a network device that is attempting to join the wireless network. There are two types authentication for this device when using WEP. **Open System** allows all wireless devices to communicate with the router before they are required to provide the encryption key needed to gain access to the network. **Shared Key** requires any wireless device attempting to communicate with the router to provide the encryption key needed to access the network before they are allowed to communicate with the router.

WEP Encryption: Here the user can specify to either use a 64Bit or a 128Bit encrypted key.

Default WEP Key: Select the default WEP key number that will be used for the encryption.

WEP Key: Enter the WEP key used here. For 64-bit keys you must enter 10 hex digits into each key box. For 128-bit keys you must enter 26 hex digits into each key box. A hex digit is either a number from 0 to 9 or a letter from A to F. You may also enter any text string into a WEP key box, in which case it will be converted into a hexadecimal key using the ASCII values of the characters. A maximum of 5 text characters can be entered for 64-bit keys, and a maximum of 13 characters for 128-bit keys.

WIRELESS SECURITY MODE

Security Mode : Enable WEP Wireless Security (basic) ▼

WEP

WEP is the wireless encryption standard. To use it you must enter the same key(s) into the AP and the wireless stations. For 64-bit keys you must enter 10 hex digits into each key box. For 128-bit keys you must enter 26 hex digits into each key box. A hex digit is either a number from 0 to 9 or a letter from A to F.

You may also enter any text string into a WEP key box, in which case it will be converted into a hexadecimal key using the ASCII values of the characters. A maximum of 5 text characters can be entered for 64-bit keys, and a maximum of 13 characters for 128-bit keys.

Authentication : Open ▼

WEP Encryption : 64Bit ▼

Default WEP Key : WEP Key 1 ▼

WEP Key : (5 ASCII or 10 HEX)

Save Settings Don't Save Settings

Wireless Security Mode: Enable WPA/WPA2 Wireless Security (enhanced)

Wi-Fi Protected Access (WPA) is a more advanced and up to date wireless encryption method used today. This is the recommended wireless security option.

The following parameters will be available for configuration:

Cipher Type: Select the appropriate cipher type to use here. Options to choose from are Temporal Key Integrity Protocol (TKIP), Advanced Encryption Standard (AES), and Both (**Auto TKIP and AES**).

Network Key: Enter the shared secret used here. This secret phrase needs to be the same on all of the wireless clients for them to be able to connect to the wireless network successfully.

Click on the **Save Settings** button to accept the changes made.

Click on the **Don't Save Settings** button to discard the changes made.

WIRELESS SECURITY MODE

Security Mode : Enable WPA/WPA2 Wireless Security (enhanced) ▼

WPA/WPA2

WPA/WPA2 requires stations to use high grade encryption and authentication.

Cipher Type : AUTO(TKIP/AES) ▼

Network Key :

(8~63 ASCII or 64 HEX)

Wireless Security

This section will show you the different levels of security you can use to protect your data from intruders. The DIR-865L offers the following types of security:

- WPA2 (Wi-Fi Protected Access 2)
- WPA (Wi-Fi Protected Access)
- WPA2-PSK (Pre-Shared Key)
- WPA-PSK (Pre-Shared Key)

What is WPA?

WPA (Wi-Fi Protected Access), is a Wi-Fi standard that was designed to improve the security features of WEP (Wired Equivalent Privacy).

The 2 major improvements over WEP:

- Improved data encryption through the Temporal Key Integrity Protocol (TKIP). TKIP scrambles the keys using a hashing algorithm and, by adding an integrity-checking feature, ensures that the keys haven't been tampered with. WPA2 is based on 802.11i and uses Advanced Encryption Standard (AES) instead of TKIP.
- User authentication, which is generally missing in WEP, through the extensible authentication protocol (EAP). WEP regulates access to a wireless network based on a computer's hardware-specific MAC address, which is relatively simple to be sniffed out and stolen. EAP is built on a more secure public-key encryption system to ensure that only authorized network users can access the network.

WPA-PSK/WPA2-PSK uses a passphrase or key to authenticate your wireless connection. The key is an alpha-numeric password between 8 and 63 characters long. The password can include symbols (!?*&_) and spaces. This key must be the exact same key entered on your wireless router or access point.

WPA/WPA2 incorporates user authentication through the Extensible Authentication Protocol (EAP). EAP is built on a more secure public key encryption system to ensure that only authorized network users can access the network.

Network Settings

This section will allow you to change the local network settings of the router and to configure the DHCP settings.

Router Settings

Router IP Address: Enter the IP address of the router. The default IP address is 192.168.0.1.

If you change the IP address, once you click **Save Settings**, you will need to enter the new IP address in your browser to get back into the configuration utility.

Subnet Mask: Enter the Subnet Mask. The default subnet mask is 255.255.255.0.

Device Name: Enter a name for the router.

Local Domain: Enter the Domain name (Optional).

Enable DNS Relay: Uncheck the box to transfer the DNS server information from your ISP to your computers. If checked, your computers will use the router for a DNS server.

ROUTER SETTINGS

Use this section to configure the internal network settings of your router. The IP Address that is configured here is the IP Address that you use to access the Web-based management interface. If you change the IP Address here, you may need to adjust your PC's network settings to access the network again.

Router IP Address :

Subnet Mask :

Device Name :

Local Domain Name :

Enable DNS Relay :

DHCP Server Settings

DHCP stands for Dynamic Host Control Protocol. The DIR-865L has a built-in DHCP server. The DHCP Server will automatically assign an IP address to the computers on the LAN/private network. Be sure to set your computers to be DHCP clients by setting their TCP/IP settings to "Obtain an IP Address Automatically." When you turn your computers on, they will automatically load the proper TCP/IP settings provided by the DIR-865L. The DHCP Server will automatically allocate an unused IP address from the IP address pool to the requesting computer. You must specify the starting and ending address of the IP address pool.

Enable DHCP Check this box to enable the DHCP server on your router.
Server: Uncheck to disable this function.

DHCP IP Address Range: Enter the starting and ending IP addresses for the DHCP server's IP assignment.

Note: If you statically (manually) assign IP addresses to your computers or devices, make sure the IP addresses are outside of this range or you may have an IP conflict.

DHCP Lease Time: The length of time for the IP address lease. Enter the Lease time in minutes.

Always Broadcast: If all the computers on the LAN successfully obtain their IP addresses from the router's DHCP server as expected, this option can remain disabled. However, if one of the computers on the LAN fails to obtain an IP address from the router's DHCP server, it may have an old DHCP client that incorrectly turns off the broadcast flag of DHCP packets.

Enabling this option will cause the router to always broadcast its responses to all clients, thereby working around the problem, at the cost of increased broadcast traffic on the LAN.

NetBIOS Announcement: Check this box to allow the DHCP Server to offer NetBIOS configuration settings to the LAN hosts. NetBIOS allow LAN hosts to discover all other computers within the network, e.g. within Network Neighborhood.

Learn NetBIOS from WAN: If NetBIOS announcement is switched on, it will cause WINS information to be learned from the WAN side, if available. Turn this setting off to configure manually.

DHCP SERVER SETTINGS

Use this section to configure the built-in DHCP server to assign IP address to the computers on your network.

Enable DHCP Server :

DHCP IP Address Range : 100 to 199 (addresses within the LAN subnet)

DHCP Lease Time : 10080 (minutes)

Always broadcast : (compatibility for some DHCP Clients)

NetBIOS announcement :

Learn NetBIOS from WAN :

NetBIOS Scope : (optional)

NetBIOS node type :

- Broadcast only (use when no WINS servers configured)
- Point-to-Point (no broadcast)
- Mixed-mode (Broadcast then Point-to-Point)
- Hybrid (Point-to-Point then Broadcast)

Primary WINS IP Address :

Secondary WINS IP Address :

NetBIOS Scope: This is an advanced setting and is normally left blank. This allows the configuration of a NetBIOS 'domain' name under which network hosts operate. This setting has no effect if the 'Learn NetBIOS information from WAN' is activated.

NetBIOS Node: This field indicates how network hosts are to perform NetBIOS name registration and discovery. H-Node, this indicates a Hybrid-State of operation. First WINS servers are tried, if any, followed by local network broadcast. This is generally the preferred mode if you have configured WINS servers. M-Node (default), this indicates a Mixed-Mode of operation. First Broadcast operation is performed to register hosts and discover other hosts, if broadcast operation fails, WINS servers are tried, if any. This mode favours broadcast operation which may be preferred if WINS servers are reachable by a slow network link and the majority of network services such as servers and printers are local to the LAN. P-Node, this indicates to use WINS servers ONLY. This setting is useful to force all NetBIOS operation to the configured WINS servers. You must have configured at least the primary WINS server IP to point to a working WINS server. B-Node, this indicates to use local network broadcast ONLY. This setting is useful where there are no WINS servers available, however, it is preferred you try M-Node operation first. This setting has no effect if the 'Learn NetBIOS information from WAN' is activated.

WINS IP Address: Enter your WINS Server IP address(es).

DHCP Reservation

If you want a computer or device to always have the same IP address assigned, you can create a DHCP reservation. The router will assign the IP address only to that computer or device.

Note: This IP address must be within the DHCP IP Address Range.

Enable: Check this box to enable the reservation.

Computer Name: Enter the computer name or select from the drop-down menu and click <<.

IP Address: Enter the IP address you want to assign to the computer or device. This IP Address must be within the DHCP IP Address Range.

MAC Address: Enter the MAC address of the computer or device.

Copy Your PC's MAC Address: If you want to assign an IP address to the computer you are currently on, click this button to populate the fields.

Save: Click **Save** to save your entry. You must click **Save Settings** at the top to activate your reservations.

DHCP Reservations List

DHCP Reservations List: Displays any reservation entries. Displays the host name (name of your computer or device), MAC Address, and IP address.

Enable: Check to enable the reservation.

Edit: Click the edit icon to make changes to the reservation entry.

Delete: Click to remove the reservation from the list.

ADD DHCP RESERVATION

Enable :

Computer Name : << PM_test01

IP Address :

MAC Address :

DHCP RESERVATIONS LIST			
Enable	Host Name	MAC Address	IP Address
<input checked="" type="checkbox"/>	PM_test01	00:04:23:2c:51:a3	192.168.0.112

NUMBER OF DYNAMIC DHCP CLIENTS : 1				
Hardware Address	Assigned IP	Hostname	Expires	
00:04:23:2c:51:a3	192.168.0.112	PM_test01	Thu Sep 1 19:49:06 2011	Revoke Reserve

DHCP RESERVATIONS LIST			
Enable	Host Name	MAC Address	IP Address
<input checked="" type="checkbox"/>	PM_test01	00:04:23:2c:51:a3	192.168.0.112

NUMBER OF DYNAMIC DHCP CLIENTS : 1				
Hardware Address	Assigned IP	Hostname	Expires	
00:04:23:2c:51:a3	192.168.0.112	PM_test01	Thu Sep 1 19:49:06 2011	Revoke Reserve

Parental Control

Parental control is a free security option that provides Anti-Phishing to protect your Internet connection from fraud and navigation improvements such as auto-correction of common URL types.

The following parameters will be available for configuration:

Advanced DNS: Select this option to enable a fast and reliable DNS with minimal blocking of phishing sites only. No OpenDNS account required.

OpenDNS® FamilyShield: Select this option to enable a fast and reliable DNS with non-configurable blocking of sites that are inappropriate or risky for children. No OpenDNS account required.

OpenDNS® Parental Control: Select this option to enable a fast and reliable DNS with configurable content filtering and phishing protection. This option includes an OpenDNS account. Click on the [‘Manage your router’](#) link to navigate to the OpenDNS account website, where you can either login (if you have an existing account) or you can register a new OpenDNS account.

None: Select this option to enable the option to specify the DNS servers provided via DHCP by their ISP or their own preferred DNS servers.

Click on the **Save Settings** button to accept the changes made.
Click on the **Don't Save Settings** button to discard the changes made.

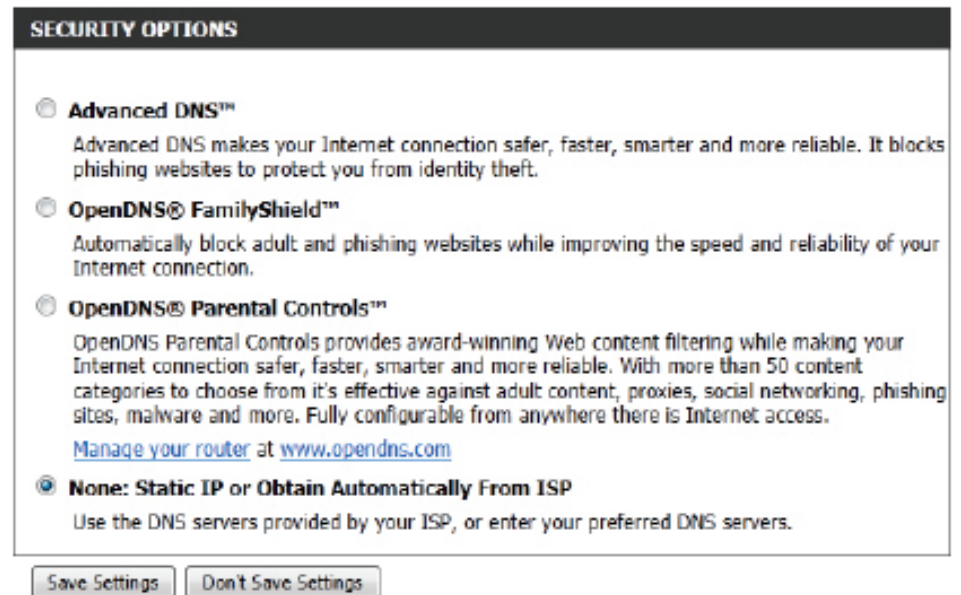
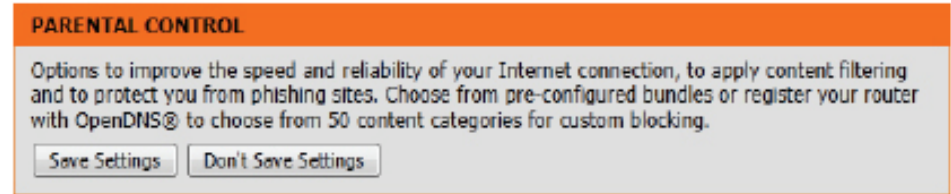

Storage

This page allows the user to use a web browser to remotely access files stored on an SD card or USB storage drive plugged into the router.

The following parameters will be available for configuration:

Enable SharePort Web Tick this option to enable the share port

Access: web access feature.

HTTP Access Port: Enter the HTTP Access Port number used here. By default, this value is 8181.

HTTPS Access Port: Enter the HTTPS Access Port number used here. By default, this value is 4433.

Allow Remote Access: Tick this option the allow remote access to this router.

In the **User Creation** section, the user can create and modify usernames and passwords.

The following parameters will be available for configuration:

User Name: In the **User Name** field we can enter the new username that will be created. Alternatively, if we want to modify an existing user account, select a username from the **drop-down** menu. It will automatically be added to the User Name field for modification.

Password: In the **Password** field, the user can enter the password that will be associated with the user account.

Verify Password: In the **Verify Password** field, the user can re-enter the password that will be associated with the user account.

Click the **Add/Edit** button the add a new user account or modify an existing account.

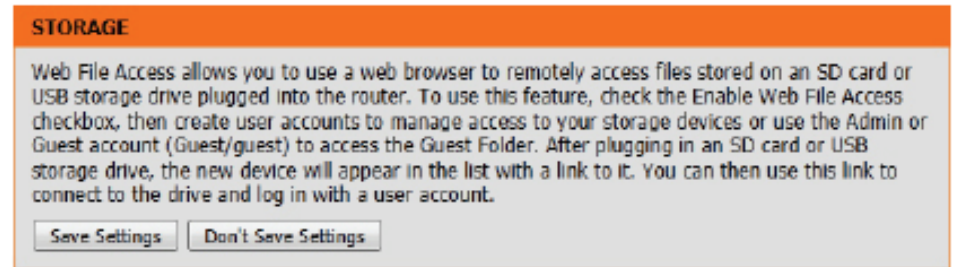

STORAGE

Web File Access allows you to use a web browser to remotely access files stored on an SD card or USB storage drive plugged into the router. To use this feature, check the Enable Web File Access checkbox, then create user accounts to manage access to your storage devices or use the Admin or Guest account (Guest/guest) to access the Guest Folder. After plugging in an SD card or USB storage drive, the new device will appear in the list with a link to it. You can then use this link to connect to the drive and log in with a user account.



SHAREPORT WEB ACCESS

Enable SharePort Web Access :

HTTP Access Port :

HTTPS Access Port :

Allow Remote Access :

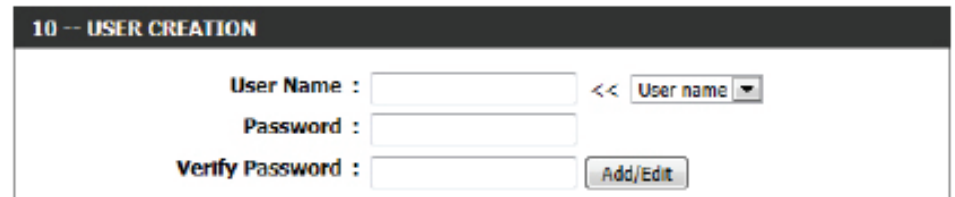

10 -- USER CREATION

User Name : <<



Password :

Verify Password :

In the **User List** section, the user can modify or delete different user settings for each account.

The following parameters will be available in the display.

- No.** Displays the number of the entry in the user list.
- User Name:** Displays the user name of the entry in the list.
- Access Path:** Displays the access path of the entry in the list.
- Permission:** Displays the permission settings of the entry in the list.

USER LIST					
No.	User Name	Access Path	Permission	Edit	Delete
1	admin	root	Read/Write		
2	Guest	USB:/Pictures	Read Only		
3	NewAccount	USB:/Video	Read/Write		

Click the **Edit** icon to edit the access path and permission, for each user.
Click the **Delete** icon to delete an account from the list.

After click on the **Edit** button, this window will appear.

The following parameters will be available for configuration:

- User Name:** This field will display the current user name that will be modified.
- Folder:** This field will display the access path that this user will have access to, after logging in. Click the Browse button to navigate to a folder, located on the USB storage device.
- Permission:** Here the user can select the appropriate permission setting for this user account. Permissions available for selection, from the drop-down menu are **Read Only** and **Read/Write**.



The dialog box titled "APPEND NEW FOLDER" contains the following fields and buttons:

- User name :** A text input field containing "Guest".
- Folder :** A text input field containing "none", followed by a "Browse" button.
- Permission :** A drop-down menu currently set to "Read Only".
- An "Append" button.
- "OK" and "Cancel" buttons at the bottom.

Read Only permission will only allow this account to read data stored on the USB storage device within the constraints of the access path specified. **Read/Write** permission will allow this account to read and write data to and from the USB storage device within the constraints of the access path specified.

Click the **Append** button to add a blank account with the access path and permission specified.
Click the **OK** button to accept the changes made for the existing account.
Click the **Cancel** button to discard the changes made.

In the **Number Devices** section, the user can view information about the external USB storage devices inserted into the USB port of this router.

The following parameters will be available in the display

Number of Devices: This field will display the number of USB storage devices that are attached to the USB port of the router.

Device: This field will display the USB storage device's name.

Total Space: This field will display the total space that is available on the USB storage device attached.

Free Space: This field will display the free space that is available on the USB storage device attached.

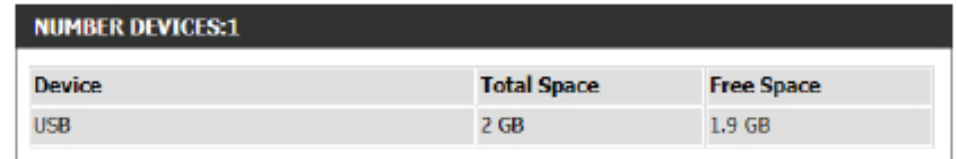

NUMBER DEVICES:1		
Device	Total Space	Free Space
USB	2 GB	1.9 GB

In the **HTTP Storage Link** section, the user can use this link to connect to the drive remotely after logging in with a user account.

Notice the path of the link(s) provided will point the external interface of this router. If no **DDNS** account is specified on the [Dynamic DNS](#) page, the WAN IP address will be used. If, however, a **DDNS** account is specified, then the domain name will be used.

Click on the **Save Settings** button to accept the changes made.

Click on the **Don't Save Settings** button to discard the changes made.

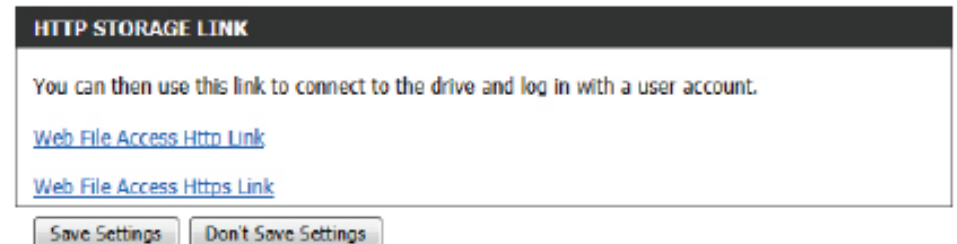

HTTP STORAGE LINK

You can then use this link to connect to the drive and log in with a user account.

[Web File Access Http Link](#)

[Web File Access Https Link](#)

IPv6

On this page, the user can configure the IPv6 Connection type. There are two ways to set up the IPv6 Internet connection. You can use the Web-based IPv6 Internet Connection Setup Wizard, or you can manually configure the connection.

For the beginner user that has not configured a router before, click on the **IPv6 Internet Connection Setup Wizard** button and the router will guide you through a few simple steps to get your network up and running.

For the advanced user that has configured a router before, click on the **Manual IPv6 Internet Connection Setup** button to input all the settings manually.

To configure the IPv6 local settings, click on the **IPv6 Local Connectivity Setup** button.

The screenshot shows the D-Link web interface for the DIR-826L router. The main navigation menu includes SETUP, ADVANCED, TOOLS, STATUS, and SUPPORT. The left sidebar lists various settings categories: INTERNET, WIRELESS SETTINGS, NETWORK SETTINGS, STORAGE, IPV6, and MYDLINK SETTINGS. The main content area is titled "IPV6 INTERNET CONNECTION" and contains three sections:

- IPV6 INTERNET CONNECTION**: A general overview stating there are two ways to set up the IPv6 Internet connection: using the Web-based IPv6 Internet Connection Setup Wizard or manually configuring the connection.
- IPV6 INTERNET CONNECTION SETUP WIZARD**: A section for users who prefer a guided setup. It includes a button for "IPv6 Internet Connection Setup Wizard" and a note advising users to follow the Quick Installation Guide.
- MANUAL IPV6 LOCAL CONNECTIVITY SETUP**: A section for users who want to configure local connectivity settings. It includes a button for "IPv6 Local Connectivity Settings".
- MANUAL IPV6 INTERNET CONNECTION SETUP**: A section for users who want to configure the IPv6 Internet settings manually. It includes a button for "Manual IPv6 Internet Connection Setup".

On the right side, there is a "Helpful Hints ..." section with text about configuring the router and a "More..." link.

The screenshot shows the "IPV6 LOCAL CONNECTIVITY SETTINGS" page. It contains the following text and controls:

Use this section to configure Unique Local IPv6 Unicast Addresses(ULA) settings for your router. ULA is intended for local communications and not expected to be routable on the global Internet.

At the bottom, there are two buttons: "Save Settings" and "Don't Save Settings".

The screenshot shows the "IPV6 ULA SETTINGS" page. It contains the following settings:

- Enable ULA**:
- Use Default ULA Prefix**:
- ULA Prefix**: /64

The screenshot shows the "CURRENT IPV6 ULA SETTINGS" page. It contains the following information:

- Current ULA Prefix**:
- LAN IPv6 ULA**:

IPv6 Internet Connection Setup Wizard

On this page, the user can configure the IPv6 Connection type using the IPv6 Internet Connection Setup Wizard.

Click the **IPv6 Internet Connection Setup Wizard** button and the router will guide you through a few simple steps to get your network up and running.



Click **Next** to continue to the next page. Click **Cancel** to discard the changes made and return to the main page.

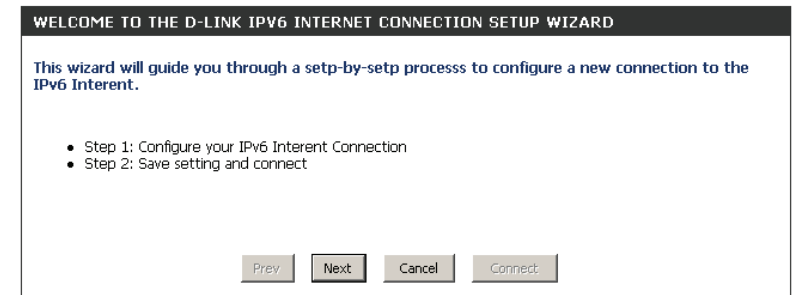

The router will try to detect whether its possible to obtain the IPv6 Internet connection type automatically. If this succeeds then the user will be guided through the input of the appropriate parameters for the connection type found.

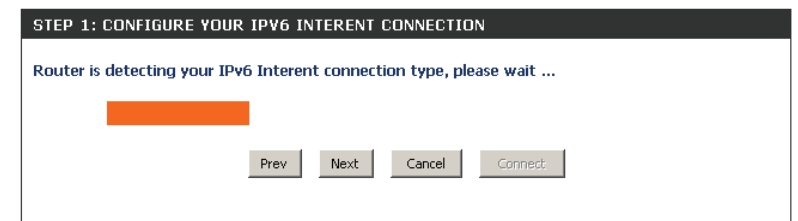

However, if the automatic detection fails, the user will be prompt to either **Try again** or to click on the **Guide me through the IPv6 settings** button to initiate the manual continual of the wizard.

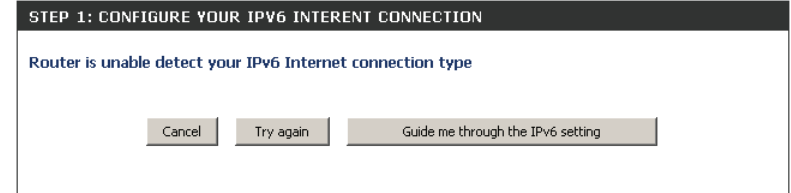

There are several connection types to choose from. If you are unsure of your connection method, please contact your IPv6 Internet Service Provider.

Note: If using the PPPoE option, you will need to ensure that any PPPoE client software on your computers has been removed or disabled. The 3 options available on this page are **IPv6 over PPPoE**, **Static IPv6 address and Route**, and **Tunneling Connection**.

Choose the required IPv6 Internet Connection type and click on the **Next** button to continue. Click on the **Prev** button to return to the previous page. Click on the **Cancel** button to discard all the changes made and return to the main page.

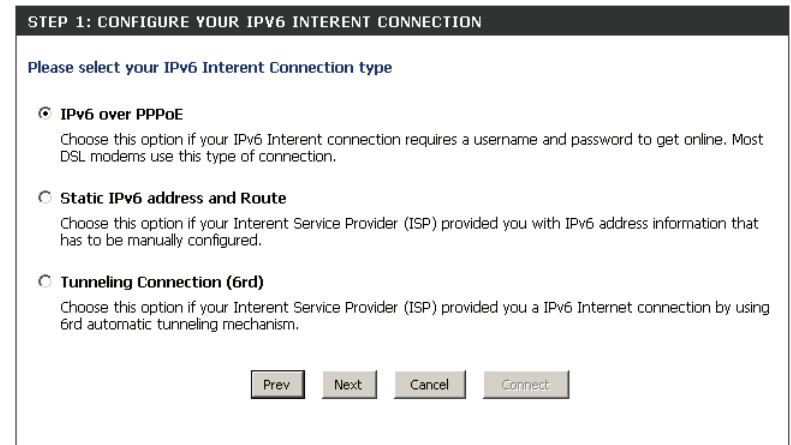

Click on the **Next** button to continue. Click on the **Prev** button to return to the previous page.

Click on the **Cancel** button to discard all the changes made and return to the main page.

IPv6 over PPPoE

After selecting the IPv6 over PPPoE option, the user will be able to configure the IPv6 Internet connection that requires a username and password to get online. Most DSL modems use this type of connection.

The following parameters will be available for configuration:

PPPoE Session: Select the PPPoE Session value used here. This option will state that this connection shares its information with the already configured IPv6 PPPoE connection, or the user can create a new PPPoE connection here.

User Name: Enter the PPPoE username used here. If you do not know your user name, please contact your ISP.

Password: Enter the PPPoE password used here. If you do not know your password, please contact your ISP.

Verify Password: Re-enter the PPPoE password used here.

Service Name: Enter the service name for this connection here. This option is optional.

SET USERNAME AND PASSWORD CONNECTION (PPPoE)

To set up this connection you will need to have a Username and Password from your IPv6 Internet Service Provider. If you do not have this information, please contact your ISP.

PPPoE Session: Share with IPv4 Create a new session

Username :

Password :

Verify Password :

Service Name : (Optional)

Note: You may also need to provide a Service Name. If you do not have or know this information, please contact your ISP.

Static IPv6 Address Connection

This mode is used when your ISP provides you with a set IPv6 addresses that does not change. The IPv6 information is manually entered in your IPv6 configuration settings. You must enter the IPv6 address, Subnet Prefix Length, Default Gateway, Primary DNS Server, and Secondary DNS Server. Your ISP provides you with all this information.

Use Link-Local Address: The Link-local address is used by nodes and routers when communicating with neighboring nodes on the same link. This mode enables IPv6-capable devices to communicate with each other on the LAN side.

IPv6 Address: Enter the WAN IPv6 address for the router here.

Subnet Prefix Length: Enter the WAN subnet prefix length value used here.

Default Gateway: Enter the WAN default gateway IPv6 address used here.

Primary IPv6 DNS Address: Enter the WAN primary DNS Server address used here.

Secondary IPv6 DNS Address: Enter the WAN secondary DNS Server address used here.

LAN IPv6 Address: These are the settings of the LAN (Local Area Network) IPv6 interface for the router. The router's LAN IPv6 Address configuration is based on the IPv6 Address and Subnet assigned by your ISP. (A subnet with prefix /64 is supported in LAN.)

SET STATIC IPv6 ADDRESS CONNECTION

To set up this connection you will need to have a complete list of IPv6 information provided by your IPv6 Internet Service Provider. If you have a Static IPv6 connection and do not have this information, please contact your ISP.

Use Link-Local Address :

IPv6 Address :

Subnet Prefix Length :

Default Gateway :

Primary DNS Address :

Secondary DNS Address :

LAN IPv6 Address : /64

Tunneling Connection (6rd)

After selecting the Tunneling Connection (6rd) option, the user can configure the IPv6 6rd connection settings.

The following parameters will be available for configuration:

6rd IPv6 Prefix: Enter the 6rd IPv6 address and prefix value used here.

IPv4 Address: Enter the IPv4 address used here.

Mask Length: Enter the IPv4 mask length used here.

Assigned IPv6 Prefix: Displays the IPv6 assigned prefix value here.

6rd Border Relay IPv4 Address: Enter the 6rd border relay IPv4 address used here.

IPv6 DNS Server: Enter the primary DNS Server address used here.

The screenshot shows a configuration window titled "SET UP 6RD TUNNELING CONNECTION". Below the title is a message: "To set up this 6rd tunneling connection you will need to have the following information from your IPv6 Internet Service Provider. If you do not have this information, please contact your ISP." The form contains the following fields and values:

- 6rd IPv6 Prefix : /
- IPv4 Address : 192.168.1.2 Mask Length :
- Assign IPv6 Prefix : None
- Tunnel Link-Local Address : FE80::COA8:0102/64
- 6rd Border Relay IPv4 Address :
- IPv6 DNS Server :

At the bottom of the window are four buttons: "Prev", "Next", "Cancel", and "Connect".

The IPv6 Internet Connection Setup Wizard is complete.

Click on the **Connect** button to continue. Click on the **Prev** button to return to the previous page. Click on the **Cancel** button to discard all the changes made and return to the main page.

The screenshot shows a confirmation window titled "SETUP COMPLETE!". Below the title is a message: "The IPv6 Internet Connection Setup Wizard has completed. Click the Connect button to save your settings and reboot the router." At the bottom of the window are four buttons: "Prev", "Next", "Cancel", and "Connect".

IPv6 Manual Setup

There are several connection types to choose from: Auto Detection, Static IPv6, Autoconfiguration (SLAAC/DHCPv6), PPPoE, IPv6 in IPv4 Tunnel, 6to4, 6rd, and Link-local. If you are unsure of your connection method, please contact your IPv6 Internet Service Provider.

Note: If using the PPPoE option, you will need to ensure that any PPPoE client software on your computers has been removed or disabled.

Auto Detection

Select **Auto Detection** to have the router detect and automatically configure your IPv6 setting from your ISP.

IPv6 CONNECTION TYPE
<p>Choose the mode to be used by the router to the IPv6 Internet.</p> <p>My IPv6 Connection is : <input type="text" value="Auto Detection"/></p>
IPv6 DNS SETTINGS
<p>Obtain a DNS server address automatically or enter a specific DNS server address.</p> <p><input checked="" type="radio"/> Obtain a DNS server address automatically</p> <p><input type="radio"/> Use the following DNS address</p> <p>Primary DNS Server : <input type="text"/></p> <p>Secondary DNS Server : <input type="text"/></p>
LAN IPv6 ADDRESS SETTINGS
<p>Use this section to configure the internal network settings of your router. If you change the LAN IPv6 Address here, you may need to adjust your PC network settings to access the network again.</p> <p>Enable DHCP-PD : <input checked="" type="checkbox"/></p> <p>LAN IPv6 Address : <input type="text"/> /64</p> <p>LAN IPv6 Link-Local Address : FE80::218:E7FF:FE95:689E/64</p>
ADDRESS AUTOCONFIGURATION SETTINGS
<p>Use this section to setup IPv6 Autoconfiguration to assign IP addresses to the computers on your network. You can also enable DHCP-PD to delegate prefixes for router in your LAN.</p> <p>Enable automatic IPv6 address assignment : <input checked="" type="checkbox"/></p> <p>Enable Automatic DHCP-PD in LAN : <input checked="" type="checkbox"/></p> <p>Autoconfiguration Type : <input type="text" value="SLAAC + Stateless DHCPv6"/></p> <p>Router Advertisement Lifetime : <input type="text" value="1440"/> (minutes)</p>

Static IPv6

My IPv6 Connection: Select **Static IPv6** from the drop-down menu.

WAN IPv6 Address Settings: Enter the address settings supplied by your Internet provider (ISP).

LAN IPv6 Address: Enter the LAN (local) IPv6 address for the router.

LAN Link-Local Address: Displays the Router's LAN Link-Local Address.

Enable Autoconfiguration: Check to enable the Autoconfiguration feature.

Autoconfiguration Type: Select **Stateful (DHCPv6)**, **SLAAC + RDNSS** or **SLAAC + Stateless DHCPv6**.

IPv6 Address Range Start: Enter the start IPv6 Address for the DHCPv6 range for your local computers.

IPv6 Address Range End: Enter the end IPv6 Address for the DHCPv6 range for your local computers.

IPv6 Address Lifetime: Enter the IPv6 Address Lifetime (in minutes).

IPv6 CONNECTION TYPE	
Choose the mode to be used by the router to the IPv6 Internet.	
My IPv6 Connection is :	Static IPv6
WAN IPv6 ADDRESS SETTINGS	
Enter the IPv6 address information provided by your Internet Service Provider (ISP).	
Use Link-Local Address :	<input checked="" type="checkbox"/>
IPv6 Address :	FE80::218:E7FF:FE95:689F
Subnet Prefix Length :	64
Default Gateway :	
Primary DNS Server :	
Secondary DNS Server :	
LAN IPv6 ADDRESS SETTINGS	
Use this section to configure the internal network settings of your router. If you change the LAN IPv6 Address here, you may need to adjust your PC network settings to access the network again.	
LAN IPv6 Address :	/64
LAN IPv6 Link-Local Address :	FE80::218:E7FF:FE95:689E/64
ADDRESS AUTOCONFIGURATION SETTINGS	
Use this section to setup IPv6 Autoconfiguration to assign IP addresses to the computers on your network.	
Enable automatic IPv6 address assignment :	<input checked="" type="checkbox"/>
Autoconfiguration Type :	SLAAC + Stateless DHCPv6
Router Advertisement Lifetime:	1440 (minutes)

Autoconfiguration

My IPv6 Connection: Select **Autoconfiguration (Stateless/DHCPv6)** from the drop-down menu.

IPv6 DNS Settings: Select either **Obtain DNS server address automatically** or **Use the following DNS Address.**

Primary/Secondary DNS Address: Enter the primary and secondary DNS server addresses.

LAN IPv6 Address: Enter the LAN (local) IPv6 address for the router.

LAN Link-Local Address: Displays the Router's LAN Link-Local Address.

Enable Autoconfiguration: Check to enable the Autoconfiguration feature.

Autoconfiguration Type: Select **Stateful (DHCPv6)**, **SLAAC + RDNSS** or **SLAAC + Stateless DHCPv6.**

IPv6 Address Range Start: Enter the start IPv6 Address for the DHCPv6 range for your local computers.

IPv6 Address Range End: Enter the end IPv6 Address for the DHCPv6 range for your local computers.

IPv6 Address Lifetime: Enter the IPv6 Address Lifetime (in minutes).

IPv6 CONNECTION TYPE	
Choose the mode to be used by the router to the IPv6 Internet.	
My IPv6 Connection is :	Autoconfiguration (SLAAC/DHCPv6) ▾
IPv6 DNS SETTINGS	
Obtain a DNS server address automatically or enter a specific DNS server address.	
<input checked="" type="radio"/> Obtain a DNS server address automatically <input type="radio"/> Use the following DNS address	
Primary DNS Server :	<input type="text"/>
Secondary DNS Server :	<input type="text"/>
LAN IPv6 ADDRESS SETTINGS	
Use this section to configure the internal network settings of your router. If you change the LAN IPv6 Address here, you may need to adjust your PC network settings to access the network again.	
Enable DHCP-PD :	<input checked="" type="checkbox"/>
LAN IPv6 Address :	<input type="text"/> /64
LAN IPv6 Link-Local Address :	FE80::218:E7FF:FE95:689E/64
ADDRESS AUTOCONFIGURATION SETTINGS	
Use this section to setup IPv6 Autoconfiguration to assign IP addresses to the computers on your network. You can also enable DHCP-PD to delegate prefixes for router in your LAN.	
Enable automatic IPv6 address assignment :	<input checked="" type="checkbox"/>
Enable Automatic DHCP-PD in LAN :	<input checked="" type="checkbox"/>
Autoconfiguration Type :	SLAAC + Stateless DHCPv6 ▾
Router Advertisement Lifetime :	1440 <input type="text"/> (minutes)

PPPoE

My IPv6 Connection: Select **PPPoE** from the drop-down menu.

PPPoE: Enter the PPPoE account settings supplied by your Internet provider (ISP).

Address Mode: Select **Static** if your ISP assigned you the IP address, subnet mask, gateway, and DNS server addresses. In most cases, select **Dynamic**.

IP Address: Enter the IP address (Static PPPoE only).

User Name: Enter your PPPoE user name.

Password: Enter your PPPoE password and then retype the password in the next box.

Service Name: Enter the ISP Service Name (optional).

Reconnection Mode: Select either **Always-on**, **On-Demand**, or **Manual**.

Maximum Idle Time: Enter a maximum idle time during which the Internet connection is maintained during inactivity. To disable this feature, enable Auto-reconnect.

MTU: Maximum Transmission Unit - you may need to change the MTU for optimal performance with your specific ISP. 1492 is the default MTU.

IPv6 DNS Settings: Select either **Obtain DNS server address automatically** or **Use the following DNS Address**.

Primary/Secondary DNS Address: Enter the primary and secondary DNS server addresses.

LAN IPv6 Address: Enter the LAN (local) IPv6 address for the router.

LAN Link-Local Address: Displays the Router's LAN Link-Local Address.

Enable Autoconfiguration: Check to enable the Autoconfiguration feature.

IPv6 CONNECTION TYPE	
Choose the mode to be used by the router to the IPv6 Internet.	
My IPv6 Connection is :	PPPoE
PPPOE	
Enter the information provided by your Internet Service Provider (ISP).	
PPPoE Session:	<input checked="" type="radio"/> Share with IPv4 <input type="radio"/> Create a new session
Address Mode :	<input checked="" type="radio"/> Dynamic IP <input type="radio"/> Static IP
IP Address :	<input type="text"/>
Username :	<input type="text"/>
Password :	<input type="text"/>
Verify Password :	<input type="text"/>
Service Name :	<input type="text"/> (Optional)
Reconnect Mode :	<input checked="" type="radio"/> Always on <input type="radio"/> On demand <input type="radio"/> Manual
Maximum Idle Time :	5 (minutes, 0=infinite)
MTU :	1492 (bytes)MTU default = 1492
IPv6 DNS SETTINGS	
Obtain a DNS server address automatically or enter a specific DNS server address.	
	<input checked="" type="radio"/> Obtain a DNS server address automatically
	<input type="radio"/> Use the following DNS address
Primary DNS Server :	<input type="text"/>
Secondary DNS Server :	<input type="text"/>
LAN IPv6 ADDRESS SETTINGS	
Use this section to configure the internal network settings of your router. If you change the LAN IPv6 Address here, you may need to adjust your PC network settings to access the network again.	
Enable DHCP-PD :	<input checked="" type="checkbox"/>
LAN IPv6 Address :	<input type="text"/> /64
LAN IPv6 Link-Local Address :	FE80::218:E7FF:FE95:689E/64
ADDRESS AUTOCONFIGURATION SETTINGS	
Use this section to setup IPv6 Autoconfiguration to assign IP addresses to the computers on your network.You can also enable DHCP-PD to delegate prefixes for router in your LAN.	
Enable automatic IPv6 address assignment :	<input checked="" type="checkbox"/>
Enable Automatic DHCP-PD in LAN :	<input checked="" type="checkbox"/>
Autoconfiguration Type :	SLAAC + Stateless DHCPv6
Router Advertisement Lifetime:	1440 (minutes)

Autoconfiguration Type: Select **Stateful (DHCPv6)**, **SLAAC + RDNSS** or **SLAAC + Stateless DHCPv6**.

IPv6 Address Range Start: Enter the start IPv6 Address for the DHCPv6 range for your local computers.

IPv6 Address Range End: Enter the end IPv6 Address for the DHCPv6 range for your local computers.

IPv6 Address Lifetime: Enter the IPv6 Address Lifetime (in minutes).

IPv6 in IPv4 Tunneling

My IPv6 Connection: Select **IPv6 in IPv4 Tunnel** from the drop-down menu.

IPv6 in IPv4 Tunnel Settings: Enter the settings supplied by your Internet provider (ISP).

LAN IPv6 Address: Enter the LAN (local) IPv6 address for the router.

LAN Link-Local Address: Displays the Router's LAN Link-Local Address.

Enable Autoconfiguration: Check to enable the Autoconfiguration feature.

Autoconfiguration Type: Select **Stateful (DHCPv6)**, **SLAAC + RDNSS** or **SLAAC + Stateless DHCPv6**.

IPv6 Address Range Start: Enter the start IPv6 Address for the DHCPv6 range for your local computers.

IPv6 Address Range End: Enter the end IPv6 Address for the DHCPv6 range for your local computers.

Pv6 Address Lifetime: Enter the Router Advertisement Lifetime (in minutes).

IPv6 CONNECTION TYPE	
Choose the mode to be used by the router to the IPv6 Internet.	
My IPv6 Connection is :	IPv6 in IPv4 Tunnel
IPv6 in IPv4 TUNNEL SETTINGS	
Enter the IPv6 in IPv4 Tunnel information provided by your Tunnel Broker.	
Remote IPv4 Address :	
Remote IPv6 Address :	
Local IPv4 Address :	192.168.1.2
Local IPv6 Address :	
IPv6 DNS SETTINGS	
Obtain a DNS server address automatically or enter a specific DNS server address.	
<input checked="" type="radio"/> Obtain a DNS server address automatically <input type="radio"/> Use the following DNS address	
Primary DNS Server :	
Secondary DNS Server :	
LAN IPv6 ADDRESS SETTINGS	
Use this section to configure the internal network settings of your router. If you change the LAN IPv6 Address here, you may need to adjust your PC network settings to access the network again.	
Enable DHCP-PD :	<input checked="" type="checkbox"/>
LAN IPv6 Address :	/64
LAN IPv6 Link-Local Address :	FE80::218:E7FF:FE95:689E/64
ADDRESS AUTOCONFIGURATION SETTINGS	
Use this section to setup IPv6 Autoconfiguration to assign IP addresses to the computers on your network. You can also enable DHCP-PD to delegate prefixes for router in your LAN.	
Enable automatic IPv6 address assignment :	<input checked="" type="checkbox"/>
Enable Automatic DHCP-PD in LAN :	<input checked="" type="checkbox"/>
Autoconfiguration Type :	SLAAC + Stateless DHCPv6
Router Advertisement Lifetime:	1440 (minutes)

6 to 4 Tunneling

My IPv6 Connection: Select **6 to 4** from the drop-down menu.

6 to 4 Settings: Enter the IPv6 settings supplied by your Internet provider (ISP).

Primary/Secondary DNS Address: Enter the primary and secondary DNS server addresses.

LAN IPv6 Address: Enter the LAN (local) IPv6 address for the router.

LAN Link-Local Address: Displays the Router's LAN Link-Local Address.

Enable Autoconfiguration: Check to enable the Autoconfiguration feature.

Autoconfiguration Type: Select **Stateful (DHCPv6)**, **SLAAC + RDNSS** or **SLAAC + Stateless DHCPv6**.

IPv6 Address Range Start: Enter the start IPv6 Address for the DHCPv6 range for your local computers.

IPv6 Address Range End: Enter the end IPv6 Address for the DHCPv6 range for your local computers.

IPv6 Address Lifetime: Enter the IPv6 Address Lifetime (in minutes).

IPv6 CONNECTION TYPE	
Choose the mode to be used by the router to the IPv6 Internet.	
My IPv6 Connection is :	6to4
6to4 SETTINGS	
Enter the IPv6 address information provided by your Internet Service Provider (ISP).	
6to4 Address :	2002:COA8:0102::COA8:0102
6to4 Relay :	192.88.99.1
Primary DNS Server :	
Secondary DNS Server :	
LAN IPv6 ADDRESS SETTINGS	
Use this section to configure the internal network settings of your router. If you change the LAN IPv6 Address here, you may need to adjust your PC network settings to access the network again.	
LAN IPv6 Address :	2002:COA8:0102:0001::1/64
LAN IPv6 Link-Local Address :	FE80::218:E7FF:FE95:689E/64
ADDRESS AUTOCONFIGURATION SETTINGS	
Use this section to setup IPv6 Autoconfiguration to assign IP addresses to the computers on your network.	
Enable automatic IPv6 address assignment :	<input checked="" type="checkbox"/>
Autoconfiguration Type :	SLAAC + Stateless DHCPv6
Router Advertisement Lifetime :	60 (minutes)

6rd

My IPv6 Connection: Select **6rd** from the drop-down menu.

6RD Settings: Enter the address settings supplied by your Internet provider (ISP).

LAN IPv6 Address: Enter the LAN (local) IPv6 address for the router.

LAN Link-Local Address: Displays the Router's LAN Link-Local Address.

Enable Autoconfiguration: Check to enable the Autoconfiguration feature.

Autoconfiguration Type: Select **Stateful (DHCPv6)**, **SLAAC+RDNSS** or **SLAAC + Stateless DHCPv6**.

Router Advertisement Lifetime: Enter the Router Advertisement Lifetime (in minutes).

IPv6 CONNECTION TYPE	
Choose the mode to be used by the router to the IPv6 Internet.	
My IPv6 Connection is :	6rd
6RD SETTINGS	
Enter the IPv6 address information provided by your Internet Service Provider (ISP).	
6rd Configuration :	<input checked="" type="radio"/> 6rd DHCPv4 Option <input type="radio"/> Manual Configuration
6rd IPv6 Prefix :	<input type="text"/> / <input type="text" value="32"/>
IPv4 Address :	192.168.1.2 Mask Length : <input type="text" value="0"/>
Assign IPv6 Prefix :	None
Tunnel Link-Local Address :	FE80::C0A8:0102/64
6rd Border Relay IPv4 Address :	<input type="text"/>
Primary DNS Server :	<input type="text"/>
Secondary DNS Server :	<input type="text"/>
LAN IPv6 ADDRESS SETTINGS	
Use this section to configure the internal network settings of your router. If you change the LAN IPv6 Address here, you may need to adjust your PC network settings to access the network again.	
LAN IPv6 Address :	None
LAN IPv6 Link-Local Address :	FE80::218:E7FF:FE95:689E/64
ADDRESS AUTOCONFIGURATION SETTINGS	
Use this section to setup IPv6 Autoconfiguration to assign IP addresses to the computers on your network.	
Enable automatic IPv6 address assignment :	<input checked="" type="checkbox"/>
Autoconfiguration Type :	SLAAC + Stateless DHCPv6
Router Advertisement Lifetime :	<input type="text" value="60"/> (minutes)

Link-Local Connectivity

My IPv6 Connection: Select **Link-Local Only** from the drop-down menu.

LAN IPv6 Address Settings: Displays the IPv6 address of the router.

IPv6 CONNECTION TYPE

Choose the mode to be used by the router to the IPv6 Internet.

My IPv6 Connection is :

LAN IPv6 ADDRESS SETTINGS

LAN IPv6 address for local IPv6 communications.

LAN IPv6 Link-Local Address : FE80::218:E7FF:FE95:689E/64

mydlink Settings

The DIR-865L features a new cloud service that pushes information such as firmware upgrade notifications, user activity, and intrusion alerts to the mydlink™ app on Android and Apple mobile devices. To insure that your router is up-to-date with the latest features, mydlink™ will notify you when an update is available for your router. You can also monitor a user's online activity with real-time website browsing history, maintaining a safe and secure environment, especially for children at home.

On this page the user can configure the mydlink™ settings for this router. This feature will allow us to use the mydlink cloud services that includes online access and management of this router through the mydlink portal website or portable device applications like iOS apps and Android applications.

In the **mydlink** section, we can view the registration status of the mydlink account service. The **mydlink Service** field will either display **Registered** or **Non-Registered**.

In the **Register mydlink Service** section, we can register or modify a mydlink account. Click on the **Register mydlink Service** button to initiate this procedure.

After clicking the **Register mydlink Service** button, this window will appear.

Register mydlink Service Wizard: Step 1

In this section we can select one of two options.

- Select the '**Yes, I have a mydlink account.**' option if you already have a mydlink account that you want to use on this router.
- Select the '**No, I want to register and login with a new mydlink account.**' option to register a new account and use it on this router.

Click the **Next** button to proceed to the next step.

Click the **Cancel** button to discard the changes made and return to the main page.

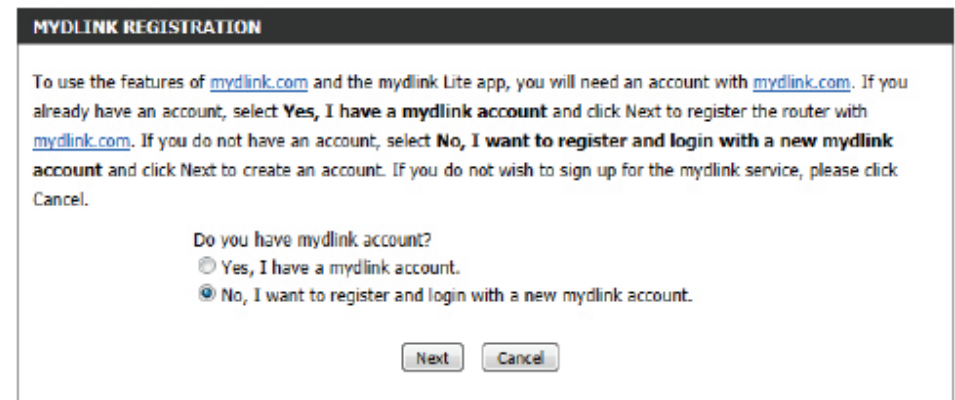
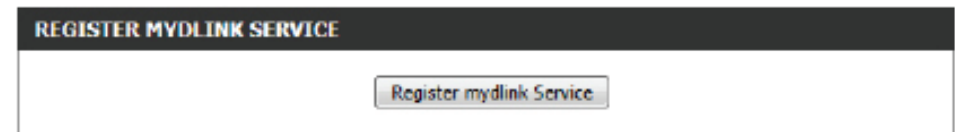
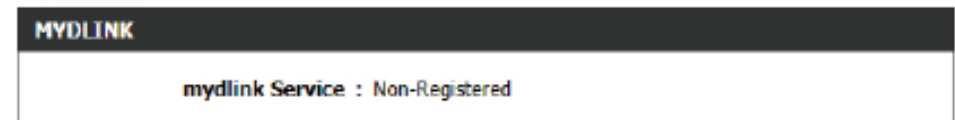
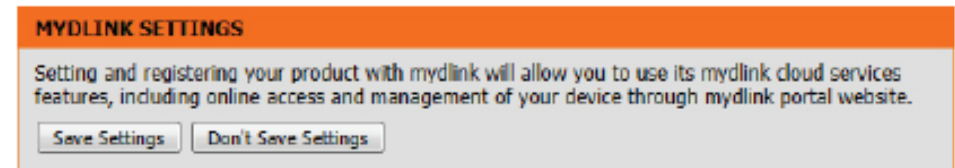

Register mydlink Service Wizard: Step 2

When registering a **new account**, the following page appears. The following parameters will be available for configuration:

- E-mail Address (Account Name):** Enter your e-mail address here. This e-mail address will also become your account name.
- Password:** Enter your preferred password choice here.
- Confirm Password:** Re-enter your preferred password choice here.
- Last Name:** Enter your last name here.
- First Name:** Enter your first name here.
- Accept terms and conditions:** Tick this option to accept the mydlink terms and conditions.

Click the **Next** button to proceed to the next step.

Click the **Prev** button to return to the previous step.

Click the **Cancel** button to discard the changes made and return to the main page.

When logging in with an **existing account**, the following page appears. The following parameters will be available for configuration:

- E-mail Address (Account Name):** Enter your e-mail address here. This e-mail address will also be your account name.
- Password:** Enter your preferred password choice here.

Click the **Login** button to login using these account details.

Click the **Prev** button to return to the previous step.

Click the **Cancel** button to discard the changes made and return to the main page.

The screenshot shows a web form titled "MYDLINK REGISTRATION" with a dark header. Below the header, the text "Please fulfill the options to complete the registration." is displayed. The form contains the following fields and elements:

- E-mail Address (Account Name) :** A text input field.
- Password :** A text input field.
- Confirm Password :** A text input field with a red prohibition sign (a circle with a diagonal slash) to its right, indicating it is required.
- Last name :** A text input field.
- First Name :** A text input field.
- A checkbox followed by the text [I Accept the mydlink terms and conditions.](#)
- Three buttons at the bottom: "Next", "Prev", and "Cancel".

The screenshot shows a web form titled "MYDLINK REGISTRATION" with a dark header. Below the header, the text "Please fulfill the options to complete the registration." is displayed. The form contains the following fields and elements:

- E-mail Address (Account Name) :** A text input field.
- Password :** A text input field.
- Three buttons at the bottom: "Login", "Prev", and "Cancel".

At any point during this wizard, we can change the preferred language used. To change the language, select the desired language option from the **Language** drop-down menu, found on the top right of this page.

End of Wizard



Advanced Virtual Server

This will allow you to open a single port. If you would like to open a range of ports, refer to the next page.

Name: Enter a name for the rule or select an application from the drop-down menu. Select an application and click << to populate the fields.

IP Address: Enter the IP address of the computer on your local network that you want to allow the incoming service to. If your computer is receiving an IP address automatically from the router (DHCP), your computer will be listed in the "Computer Name" drop-down menu. Select your computer and click <<.

Private Port/ Public Port: Enter the port that you want to open next to Private Port and Public Port. The private and public ports are usually the same. The public port is the port seen from the Internet side, and the private port is the port being used by the application on the computer within your local network.

Protocol Type: Select **TCP**, **UDP**, or **Both** from the drop-down menu.

Schedule: The schedule of time when the Virtual Server Rule will be enabled. The schedule may be set to Always, which will allow the particular service to always be enabled. You can create your own times in the **Tools > Schedules** section.

Inbound Filter: Select **Allow All** (most common) or a created Inbound filter. You may create your own inbound filters in the **Advanced > Inbound Filter** page.



24 - VIRTUAL SERVERS LIST					
Remaining number of rules that can be created: 24					
			Port	Traffic Type	
<input type="checkbox"/>	Name	<< Application name ▼	Public Port	Protocol	Schedule
				Both ▼	Always ▼
	IP Address	<< Computer Name ▼	Private Port		Inbound Filter
					Allow All ▼
<input type="checkbox"/>	Name	<< Application name ▼	Public Port	Protocol	Schedule
				Both ▼	Always ▼
	IP Address	<< Computer Name ▼	Private Port		Inbound Filter
					Allow All ▼

Port Forwarding

This will allow you to open a single port or a range of ports.

Name: Enter a name for the rule or select an application from the drop-down menu. Select an application and click << to populate the fields.

IP Address: Enter the IP address of the computer on your local network that you want to allow the incoming service to. If your computer is receiving an IP address automatically from the router (DHCP), your computer will be listed in the "Computer Name" drop-down menu. Select your computer and click <<.

TCP/UDP: Enter the TCP and/or UDP port or ports that you want to open. You can enter a single port or a range of ports. Separate ports with a common.

Example: 24,1009,3000-4000

Schedule: The schedule of time when the Virtual Server Rule will be enabled. The schedule may be set to **Always**, which will allow the particular service to always be enabled. You can create your own times in the **Tools > Schedules** section.

Inbound Filter: Select **Allow All** (most common) or a created Inbound filter. You may create your own inbound filters in the **Advanced > Inbound Filter** page.

PORT FORWARDING

This option is used to open multiple ports or a range of ports in your router and redirect data through those ports to a single PC on your network. This feature allows you to enter ports in the format, Port Ranges (100-150), Individual Ports (80, 68, 888), or Mixed (1020-5000, 689). This option is only applicable to the INTERNET session.

24 -- PORT FORWARDING RULES

Remaining number of rules that can be created: 24

			Ports to Open	
<input type="checkbox"/>	Name <input type="text"/>	<< Application Name ▼	TCP <input type="text"/>	Schedule Always ▼
	IP Address <input type="text"/>	<< Computer Name ▼	UDP <input type="text"/>	Inbound Filter Allow All ▼
<input type="checkbox"/>	Name <input type="text"/>	<< Application Name ▼	TCP <input type="text"/>	Schedule Always ▼
	IP Address <input type="text"/>	<< Computer Name ▼	UDP <input type="text"/>	Inbound Filter Allow All ▼

Application Rules

Some applications require multiple connections, such as Internet gaming, video conferencing, Internet telephony and others. These applications have difficulties working through NAT (Network Address Translation). Special Applications makes some of these applications work with the DIR-865L. If you need to run applications that require multiple connections, specify the port normally associated with an application in the "Trigger Port" field, select the protocol type as TCP or UDP, then enter the firewall (public) ports associated with the trigger port to open them for inbound traffic.

The DIR-865L provides some predefined applications in the table on the bottom of the web page. Select the application you want to use and enable it.

Name: Enter a name for the rule. You may select a pre-defined application from the drop-down menu and click <<.

Trigger: This is the port used to trigger the application. It can be either a single port or a range of ports.

Traffic Type: Select the protocol of the trigger port (TCP, UDP, or Both).

Firewall: This is the port number on the Internet side that will be used to access the application. You may define a single port or a range of ports. You can use a comma to add multiple ports or port ranges.

Traffic Type: Select the protocol of the firewall port (TCP, UDP, or Both).

Schedule: The schedule of time when the Application Rule will be enabled. The schedule may be set to Always, which will allow the particular service to always be enabled. You can create your own times in the **Tools > Schedules** section.

APPLICATION RULES

The Application Rules option is used to open single or multiple ports in your firewall when the router senses data sent to the Internet on an outgoing "Trigger" port or port range. Special Application rules apply to all computers on your internal network.

24 -- APPLICATION RULES					
Remaining number of rules that can be created: 24					
	Name	Application	Port	Traffic Type	Schedule
<input type="checkbox"/>	<input type="text"/>	<input type="button" value="<<"/> Application Name ▼	Trigger <input type="text"/>	All ▼	Always ▼
			Firewall <input type="text"/>	All ▼	
<input type="checkbox"/>	<input type="text"/>	<input type="button" value="<<"/> Application Name ▼	Trigger <input type="text"/>	All ▼	Always ▼
			Firewall <input type="text"/>	All ▼	

QoS Engine

The QoS Engine option helps improve your network gaming performance by prioritizing applications. By default the QoS Engine settings are disabled and application priority is not classified automatically. The QoS section contains a queuing mechanism, traffic shaping and classification. It supports two kinds of queuing mechanisms. Strict Priority Queue (SPQ) and Weighted Fair Queue (WFQ). SPQ will process traffic based on traffic priority. Queue1 has the highest priority and Queue4 has the lowest priority. WFQ will process traffic based on the queue weight. Users can configure each queue's weight. The sum of all the queue's weight must be 100. When surfing the Internet, the system will do traffic shaping based on the uplink and downlink speed. The classification rules can be used to classify traffic to different queues, then SPQ or WFQ will do QoS based on the queue's priority or weight.

The following parameters will be available for configuration:

Enable QoS: This option is disabled by default. Enable this option for better performance and experience with online games and other interactive applications, such as VoIP.

Uplink Speed: The speed at which data can be transferred from the router to your ISP. This is determined by your ISP. ISP's often define speed as a download/upload pair. For example, 1.5Mbps/284Kbits. Using this example, you would enter 284. Alternatively you can test your uplink speed with a service such as www.dslreports.com.

Downlink Speed: The speed at which data can be transferred from the ISP to the router. This is determined by your ISP. ISP's often define speed as a download/upload pair. For example, 1.5Mbps/284Kbits. Using this example, you would enter 1500. Alternatively you can test your downlink speed with a service such as www.dslreports.com.

Queue Type: Here the user can specify the queue type used. When choosing the option Strict Priority Queue, the router will apply QoS based on the internal specification for the queue ID's listed. When choosing the option Weight Fair Queue, the router will apply QoS based on the user defined percentage in the Queue Weight column.

Queue ID: In this column the Queue ID used will be displayed.

QoS SETTINGS

Use this section to configure D-Link's QoS Engine powered by QoS Engine Technology. This QoS Engine improves your online gaming experience by ensuring that your game traffic is prioritized over other network traffic, such as FTP or Web. For best performance, use the Automatic Classification option to automatically set the priority for your applications.

QoS SETUP

Enable QoS :

Uplink Speed : kbps <<

Downlink Speed : kbps <<

Queue Type : Strict Priority Queue Weighted Fair Queue

Queue ID	Queue Weight
1	<input type="text" value="40"/> %
2	<input type="text" value="30"/> %
3	<input type="text" value="20"/> %
4	<input type="text" value="10"/> %

Queue Priority: In this column the Queue Priority used will be displayed.

Queue Weight: After choosing to use the Weight Fair Queue option, under Queue Type, the user will be able to manual enter the Queue Weight for each individual Queue ID.

After specifying the QoS framework used, in the QoS setup section, the user can now create individual rules for scenarios that require the use of traffic control and data priority manipulation.

The following parameters will be available for configuration:

Checkbox: Tick this option to enable the rule specified.

Name: Enter a custom name for the rule being created here. This name is used for identification.

Queue ID: Select the appropriate priority requirement from the drop-down menu that will be applied to this rule. Option to choose from are Highest, Higher, Normal, and Best Effort.

Protocol: Select the protocol used for the application for in the drop-down menu and it will automatically place it in the Protocol field.

Local IP Range: Enter the local IP range used here. This is the IP range of you Local Area Network. The Router's IP cannot be included in this range.

Remote IP Range: Enter the remote IP range used here. This is the IP range of the public network from the Internet Port side. To apply this rule to any IP addresses from the public side, enter the range 0.0.0.1 to 255.255.255.254.

Application Port: Enter the application port number used here.

Click on the **Save Settings** button to accept the changes made.
Click on the **Don't Save Settings** button to discard the changes made.

32 -- CLASSIFICATION RULES

Remaining number of rules that can be created: 18

<input type="checkbox"/>	Name Youtube	Queue ID 1 - Highest	Protocol TCP << ALL
<input checked="" type="checkbox"/>	Local IP Range [] to []	Remote IP Range [] to []	Application Port YOUTUBE << ALL
<input type="checkbox"/>	Name Google_talk	Queue ID 1 - Highest	Protocol TCP << ALL
<input checked="" type="checkbox"/>	Local IP Range [] to []	Remote IP Range [] to []	Application Port VOICE << ALL
<input type="checkbox"/>	Name Web_audio	Queue ID 1 - Highest	Protocol TCP << ALL
<input checked="" type="checkbox"/>	Local IP Range [] to []	Remote IP Range [] to []	Application Port HTTP_AUDIO << ALL
<input type="checkbox"/>	Name Web_video	Queue ID 2 - Higher	Protocol TCP << ALL
<input checked="" type="checkbox"/>	Local IP Range [] to []	Remote IP Range [] to []	Application Port HTTP_VIDEO << ALL

Network Filters

Use MAC (Media Access Control) Filters to allow or deny LAN (Local Area Network) computers by their MAC addresses from accessing the network. You can either manually add a MAC address or select the MAC address from the list of clients that are currently connected to the Broadband Router.

Configure MAC Filtering: Select **Turn MAC Filtering Off, Allow MAC addresses listed below**, or **Deny MAC addresses listed below** from the drop-down menu.

MAC Address: Enter the MAC address you would like to filter.

To find the MAC address on a computer, please refer to the *Networking Basics* section in this manual.

DHCP Client: Select a DHCP client from the drop-down menu and click << to copy that MAC Address.

24 -- MAC FILTERING RULES

Configure MAC Filtering below:
 Turn MAC Filtering ON and ALLOW computers listed to access the network ▼

Remaining number of rules that can be created: **24**

	MAC Address		DHCP Client List	Schedule
<input type="checkbox"/>	<input type="text"/>	<<	Computer Name ▼	Always ▼ <input type="button" value="New Schedule"/>
<input type="checkbox"/>	<input type="text"/>	<<	Computer Name ▼	Always ▼ <input type="button" value="New Schedule"/>
<input type="checkbox"/>	<input type="text"/>	<<	Computer Name ▼	Always ▼ <input type="button" value="New Schedule"/>
<input type="checkbox"/>	<input type="text"/>	<<	Computer Name ▼	Always ▼ <input type="button" value="New Schedule"/>
<input type="checkbox"/>	<input type="text"/>	<<	Computer Name ▼	Always ▼ <input type="button" value="New Schedule"/>
<input type="checkbox"/>	<input type="text"/>	<<	Computer Name ▼	Always ▼ <input type="button" value="New Schedule"/>
<input type="checkbox"/>	<input type="text"/>	<<	Computer Name ▼	Always ▼ <input type="button" value="New Schedule"/>
<input type="checkbox"/>	<input type="text"/>	<<	Computer Name ▼	Always ▼ <input type="button" value="New Schedule"/>
<input type="checkbox"/>	<input type="text"/>	<<	Computer Name ▼	Always ▼ <input type="button" value="New Schedule"/>

Access Control

The Access Control section allows you to control access in and out of your network. Use this feature as Parental Controls to only grant access to approved sites, limit web access based on time or dates, and/or block access from applications like P2P utilities or games.

Add Policy: Click the **Add Policy** button to start the Access Control Wizard.

D-Link

DIR-826L // SETUP ADVANCED TOOLS STATUS SUPPORT

ACCESS CONTROL

The Access Control option allows you to control access in and out of your network. Use this feature as Access Controls to only grant access to approved sites, limit web access based on time or dates, and/or block internet access for applications like P2P utilities or games.

Save Settings Don't Save Settings

ACCESS CONTROL

Enable Access Control:

Add Policy

POLICY TABLE

Enable Policy	Machine	Filtering	Logged	Schedule

Helpful Hints...

Check **Enable Access Control** if you want to enforce rules that limit Internet access from specific LAN computers.

Click **Add Policy** to start the processes of creating a rule. You can cancel the process at any time. When you are finished creating a rule it will be added to the **Policy Table** below.

Click the **Edit** icon to modify an existing rule using the Policy Wizard.

Click the **Delete** icon to permanently remove a rule.

Access Control Wizard

Click **Next** to continue with the wizard.

ADD NEW POLICY

This wizard will guide you through the following steps to add a new policy for Access Control.

Step 1 - Choose a unique name for your policy
 Step 2 - Select a schedule
 Step 3 - Select the machine to which this policy applies
 Step 4 - Select filtering method
 Step 5 - Select filters
 Step 6 - Configure Web Access Logging

Prev Next Save Cancel

Enter a name for the policy and then click **Next** to continue.

STEP 1: CHOOSE POLICY NAME

Choose a unique name for your policy.

Policy Name :

Select a schedule (I.E. Always) from the drop-down menu and then click **Next** to continue.

STEP 2: SELECT SCHEDULE

Choose a schedule to apply to this policy.

Details :

Enter the following information and then click **Next** to continue.

- **Address Type** - Select IP address, MAC address, or Other Machines.
- **IP Address** - Enter the IP address of the computer you want to apply the rule to.
- **Machine Address** - Enter the PC MAC address (i.e. 00:00.00.00.00).

STEP 3: SELECT MACHINE

Select the machine to which this policy applies.

Specify a machine with its IP or MAC address, or select "Other Machines" for machines that do not have a policy.

Address Type : IP MAC Other Machines

IP Address : <<

Machine Address : <<

Machine
192.168.0.112

Select the filtering method and then click **Next** to continue.

STEP 4: SELECT FILTERING METHOD

Select the method for filtering.

Method : Log Web Access Only Block All Access Block Some Access

Apply Web Filter :

Apply Advanced Port Filters :

Enter the rule:

Enable - Check to enable the rule.

Name - Enter a name for your rule.

Dest IP Start - Enter the starting IP address.

Dest IP End - Enter the ending IP address.

Protocol - Select the protocol.

Dest Port Start - Enter the starting port number.

Dest Port End - Enter the ending port number.

STEP 5: PORT FILTER

Add Port Filters Rules.

Specify rules to prohibit access to specific IP addresses and ports.

Enable	Name	Dest IP Start	Dest IP End	Protocol	Dest Port Start	Dest Port End
<input type="checkbox"/>		0.0.0.0	255.255.255.255	Any	0	65535
<input type="checkbox"/>		0.0.0.0	255.255.255.255	Any	0	65535
<input type="checkbox"/>		0.0.0.0	255.255.255.255	Any	0	65535
<input type="checkbox"/>		0.0.0.0	255.255.255.255	Any	0	65535
<input type="checkbox"/>		0.0.0.0	255.255.255.255	Any	0	65535
<input type="checkbox"/>		0.0.0.0	255.255.255.255	Any	0	65535
<input type="checkbox"/>		0.0.0.0	255.255.255.255	Any	0	65535
<input type="checkbox"/>		0.0.0.0	255.255.255.255	Any	0	65535

Prev Next Save Cancel

To enable web logging, click **Enable**.

Click **Save** to save the access control rule.

STEP 6: CONFIGURE WEB ACCESS LOGGING

Web Access Logging : Disabled
 Enable

Prev Next Save Cancel

Your newly created policy will now show up under **Policy Table**.

ACCESS CONTROL

The Access Control option allows you to control access in and out of your network. Use this feature as Access Controls to only grant access to approved sites, limit web access based on time or dates, and/or block internet access for applications like P2P utilities or games.

Save Settings Don't Save Settings Reboot Now

ENABLE

Enable Access Control :

Add Policy

POLICY TABLE

Enable Policy	Machine	Filtering	Logged	Schedule		
<input checked="" type="checkbox"/>	dlink	192.168.0.106	Block Some Access	No	Always	

Website Filters

Website Filters are used to allow you to set up a list of Web sites that can be viewed by multiple users through the network. To use this feature select to **Allow** or **Deny**, enter the domain or website and click **Save Settings**. You must also select **Apply Web Filter** under the *Access Control* section.

Add Website Select either **DENY computers access to ONLY Filtering Rule: these sites** or **ALLOW computers access to ONLY these sites**.

Website URL/ Domain: Enter the keywords or URLs that you want to allow or block. Click **Save Settings**.

40 -- WEBSITE FILTERING RULES

Configure Website Filter below:

DENY computers access to ONLY these sites ▼

Clear the list below...

Website URL/Domain	

Inbound Filters

The Inbound Filter option is an advanced method of controlling data received from the Internet. With this feature you can configure inbound data filtering rules that control data based on an IP address range. Inbound Filters can be used with Virtual Server, Port Forwarding, or Remote Administration features.

Name: Enter a name for the inbound filter rule.

Action: Select **Allow** or **Deny**.

Enable: Check to enable rule.

Remote IP Start: Enter the starting IP address. Enter 0.0.0.0 if you do not want to specify an IP range.

Remote IP End: Enter the ending IP address. Enter 255.255.255.255 if you do not want to specify an IP range.

Add: Click the **Add** button to apply your settings. You must click **Save Settings** at the top to save the settings.

Inbound Filter Rules List: This section will list any rules that are created. You may click the **Edit** icon to change the settings or enable/disable the rule, or click the **Delete** icon to remove the rule.

INBOUND FILTER

The Inbound Filter option is an advanced method of controlling data received from the Internet. With this feature you can configure inbound data filtering rules that control data based on an IP address range.

Inbound Filters can be used for limiting access to a server on your network to a system or group of systems. Filter rules can be used with Virtual Server, Port Forwarding, or Remote Administration features.

ADD INBOUND FILTER RULE

Name :

Action :

Remote IP Range	Enable	Remote IP Start	Remote IP End
<input type="text" value="0.0.0.0"/>	<input type="checkbox"/>	<input type="text" value="0.0.0.0"/>	<input type="text" value="255.255.255.255"/>
<input type="text" value="0.0.0.0"/>	<input type="checkbox"/>	<input type="text" value="0.0.0.0"/>	<input type="text" value="255.255.255.255"/>
<input type="text" value="0.0.0.0"/>	<input type="checkbox"/>	<input type="text" value="0.0.0.0"/>	<input type="text" value="255.255.255.255"/>
<input type="text" value="0.0.0.0"/>	<input type="checkbox"/>	<input type="text" value="0.0.0.0"/>	<input type="text" value="255.255.255.255"/>
<input type="text" value="0.0.0.0"/>	<input type="checkbox"/>	<input type="text" value="0.0.0.0"/>	<input type="text" value="255.255.255.255"/>
<input type="text" value="0.0.0.0"/>	<input type="checkbox"/>	<input type="text" value="0.0.0.0"/>	<input type="text" value="255.255.255.255"/>
<input type="text" value="0.0.0.0"/>	<input type="checkbox"/>	<input type="text" value="0.0.0.0"/>	<input type="text" value="255.255.255.255"/>
<input type="text" value="0.0.0.0"/>	<input type="checkbox"/>	<input type="text" value="0.0.0.0"/>	<input type="text" value="255.255.255.255"/>

INBOUND FILTER RULES LIST

Name	Action	Remote IP Range		
Inbound1	allow	192.168.1.0-192.168.1.254		

Firewall Settings

A firewall protects your network from the outside world. The DIR-865L offers a firewall type functionality. The SPI feature helps prevent cyber attacks. Sometimes you may want a computer exposed to the outside world for certain types of applications. If you choose to expose a computer, you can enable DMZ. DMZ is short for Demilitarized Zone. This option will expose the chosen computer completely to the outside world.

Enable SPI: SPI (Stateful Packet Inspection, also known as dynamic packet filtering) helps to prevent cyber attacks by tracking more state per session. It validates that the traffic passing through the session conforms to the protocol.

Anti-Spoof Check: Enable this feature to protect your network from certain kinds of “spoofing” attacks.

NAT Endpoint Filtering: Select one of the following for TCP and UDP ports:
 Endpoint Independent - Any incoming traffic sent to an open port will be forwarded to the application that opened the port. The port will close if idle for 5 minutes.
Address Restricted - Incoming traffic must match the IP address of the outgoing connection.
Address + Port Restriction - Incoming traffic must match the IP address and port of the outgoing connection.

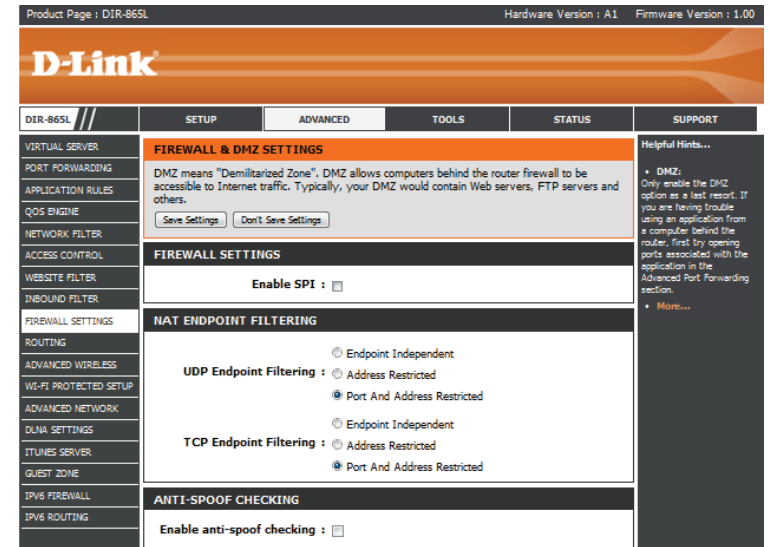

DMZ IP Address: Specify the IP address of the computer on the LAN that you want to have unrestricted Internet communication. If this computer obtains its IP address automatically using DHCP, be sure to make a static reservation on the **Setup > Network Settings** page so that the IP address of the DMZ machine does not change.

PPTP: Allows multiple machines on the LAN to connect to their corporate network using PPTP protocol.

IPSEC (VPN): Allows multiple VPN clients to connect to their corporate network using IPsec. Some VPN clients support traversal of IPsec through NAT. This ALG may interfere with the operation of such VPN clients. If you are having trouble connecting with your corporate network, try turning this ALG off. Please check with the system administrator of your corporate network whether your VPN client supports NAT traversal.

RTSP: Allows application that uses Real Time Streaming Protocol to receive streaming media from the Internet. QuickTime and Real Player are some of the common applications using this protocol.

SIP: Allows devices and applications using VoIP (Voice over IP) to communicate across NAT. Some VoIP applications and devices have the ability to discover NAT devices and work around them. This ALG may interfere with the operation of such devices. If you are having trouble making VoIP calls, try turning this ALG off.

The screenshot displays the configuration page for the Firewall Settings on a D-Link router. The left sidebar lists various settings categories, with 'FIREWALL SETTINGS' selected. The main content area is divided into several sections:

- NAT ENDPOINT FILTERING:** Contains two sections:
 - UDP Endpoint Filtering:** Radio buttons for 'Endpoint Independent', 'Address Restricted', and 'Port And Address Restricted'. 'Port And Address Restricted' is selected.
 - TCP Endpoint Filtering:** Radio buttons for 'Endpoint Independent', 'Address Restricted', and 'Port And Address Restricted'. 'Port And Address Restricted' is selected.
- ANTI-SPOOF CHECKING:** A checkbox for 'Enable anti-spoof checking' which is currently unchecked.
- DMZ HOST:** A section with a descriptive paragraph about the DMZ (Demilitarized Zone) option. Below the text is a checkbox for 'Enable DMZ' (unchecked), a text input field for 'DMZ IP Address' with a '<<' button, and a dropdown menu for 'Computer Name'.
- APPLICATION LEVEL GATEWAY (ALG) CONFIGURATION:** A section with four checkboxes: 'PPTP' (checked), 'IPSec (VPN)' (checked), 'RTSP' (checked), and 'SIP' (checked).

At the bottom of the page, there are two buttons: 'Save Settings' and 'Don't Save Settings'.

Routing

The Routing option is an advanced method of customizing specific routes of data through your network.

Name: Enter a name for your route.

Destination IP: Enter the IP address of packets that will take this route.

Netmask: Enter the netmask of the route, please note that the octets must match your destination IP address.

Gateway: Enter your next hop gateway to be taken if this route is used.

Metric: The route metric is a value from 1 to 16 that indicates the cost of using this route. A value 1 is the lowest cost and 15 is the highest cost.

Interface: Select the interface that the IP packet must use to transit out of the router when this route is used.

Product Page : DIR-865L Hardware Version : A1 Firmware Version : 1.00

D-Link

DIR-865L // SETUP ADVANCED TOOLS STATUS SUPPORT

ROUTING

The Routing option allows you to define static routes to specific destinations.

Save Settings Don't Save Settings

32 -- ROUTE LIST

Remaining number of rules that can be created: 32

	Name	Destination IP	Metric	Interface
<input type="checkbox"/>	<input type="text"/>	<input type="text"/>	1	WAN 0
	Netmask	Gateway		
<input type="checkbox"/>	<input type="text"/>	<input type="text"/>	1	WAN 0
	Netmask	Gateway		
<input type="checkbox"/>	<input type="text"/>	<input type="text"/>	1	WAN 0
	Netmask	Gateway		

Helpful Hints...

- **Enable:** Specifies whether the entry will be enabled or disabled.
- **Interface:** Specifies the interface -- WAN -- that the IP packet must use to transit out of the router, when this route is used.
- **Destination IP:** The IP address of packets that will take this route.
- **Netmask:** One bit in the mask specifies which bits of the IP address must match.
- **Gateway:** The gateway IP address is the IP address of the router, if any, used to reach the specified destination.
- **More...**

Advanced Wireless

Transmit Power: Set the transmit power of the antennas.

WLAN Partition: This enables 802.11d operation. 802.11d is a wireless specification developed to allow implementation of wireless networks in countries that cannot use the 802.11 standard. This feature should only be enabled if you are in a country that requires it.

WMM Enable: WMM is QoS for your wireless network. This will improve the quality of video and voice applications for your wireless clients.

Short GI: Check this box to reduce the guard interval time therefore increasing the data capacity. However, it's less reliable and may create higher data loss.

HT20/40 Coexistence: Enable this option to reduce interference from other wireless networks in your area. If the channel width is operating at 40MHz and there is another wireless network's channel over-lapping and causing interference, the router will automatically change to 20MHz.

The screenshot displays the D-Link DIR-826L Advanced Wireless configuration interface. The top navigation bar includes tabs for SETUP, ADVANCED, TOOLS, STATUS, and SUPPORT. The left sidebar lists various configuration categories, with 'ADVANCED WIRELESS' selected. The main content area is divided into two sections for 2.4GHz and 5GHz wireless settings.

2.4GHz Advanced Wireless Settings:

- Wireless Band : 2.4GHz
- Transmit Power : High
- WLAN Partition :
- WMM Enable :
- Short GI :
- HT 20/40 MHz Coexistence : Enable Disable

5GHz Advanced Wireless Settings:

- Wireless Band : 5GHz
- Transmit Power : High
- WLAN Partition :
- WMM Enable :
- Short GI :

Helpful Hints ...

It is recommended that you leave these parameters at their default values. Adjusting them could limit the performance of your wireless network.

Enabling WMM can help control latency and jitter when transmitting multimedia content over a wireless connection.

[More...](#)

Wi-Fi Protected Setup (WPS)

Wi-Fi Protected Setup (WPS) System is a simplified method for securing your wireless network during the “Initial setup” as well as the “Add New Device” processes. The Wi-Fi Alliance (WFA) has certified it across different products as well as manufactures. The process is just as easy as pressing a button for the Push-Button Method or correctly entering the 8-digit code for the Pin Code Method. The time reduction in setup and ease of use are quite beneficial, while the highest wireless Security setting of WPA2 is automatically used.

Enable: Enable the Wi-Fi Protected Setup feature.

Note: if this option is unchecked, the WPS button on the side of the router will be disabled.

Lock Wireless Security Settings: Tick this option to lock the configured wireless security settings.

PIN Settings: A PIN is a unique number that can be used to add the router to an existing network or to create a new network. Only the Administrator (“admin” account) can change or reset the PIN.

Current PIN: Shows the current PIN.

Reset PIN to Default: Restore the default PIN of the router.

Generate New PIN: Create a random number that is a valid PIN. This becomes the router’s PIN. You can then copy this PIN to the user interface of the wireless client.

Product Page : DIR-865L Hardware Version : A1 Firmware Version : 1.00

D-Link

DIR-865L // SETUP ADVANCED TOOLS STATUS SUPPORT

WI-FI PROTECTED SETUP

Wi-Fi Protected Setup is used to easily add devices to a network using a PIN or button press. Devices must support Wi-Fi Protected Setup in order to be configured by this method. If the PIN changes, the new PIN will be used in following Wi-Fi Protected Setup process. Clicking on "Don't Save Settings" button will not reset the PIN. However, if the new PIN is not saved, it will get lost when the device reboots or loses power.

Save Settings Don't Save Settings

WI-FI PROTECTED SETUP

Enable :

WiFi Protected Setup : Enable/Not Configured

Lock WPS-PIN Setup :

Reset to Unconfigured

PIN SETTINGS

PIN : 85679832

Reset PIN to Default Generate New PIN

ADD WIRELESS STATION

Connect your Wireless Device

Save Settings Don't Save Settings

Helpful Hints...

- Enable if other wireless devices you wish to include in the local network support Wi-Fi Protected Setup.
- Only "Admin" account can change security settings.
- Lock WPS-PIN Setup Locking the WPS-PIN Method prevents the settings from being changed by any new external registrar using its PIN. Devices can still be added to the wireless network using Wi-Fi Protected Setup Push Button Configuration (WPS-PIN).
- Click Connect your Wireless Device to use Wi-Fi Protected Setup to add wireless devices to the wireless network.
- More...

Add Wireless Station: This Wizard helps you add wireless devices to the wireless network.

The wizard will either display the wireless network settings to guide you through manual configuration, prompt you to enter the PIN for the device, or ask you to press the configuration button on the device. If the device supports Wi-Fi Protected Setup and has a configuration button, you can add it to the network by pressing the configuration button on the device and then the on the router within 120 seconds. The status LED on the router will flash three times if the device has been successfully added to the network.

There are several ways to add a wireless device to your network. A “registrar” controls access to the wireless network. A registrar only allows devices onto the wireless network if you have entered the PIN, or pressed a special Wi-Fi Protected Setup button on the device. The router acts as a registrar for the network, although other devices may act as a registrar as well.

Add Wireless Device Wizard: Click to start the wizard and skip to page 48.

WPS Button

You can also simply press the WPS button on the side of the router, and then press the WPS button on your wireless client to automatically connect without logging into the router.

Refer to page 130 for more information.



Advanced Network Settings

Enable UPnP: To use the Universal Plug and Play (UPnP™) feature click on **Enabled**. UPnP provides compatibility with networking equipment, software and peripherals.

WAN Ping: Checking the box will allow the DIR-865L to respond to pings. Unchecking the box may provide some extra security from hackers.

WAN Port Speed: You may set the port speed of the Internet port to 10Mbps, 100Mbps, 1000Mbps, or Auto (recommended).

Enable IPV4 Multicast Streams: Check the box to allow multicast traffic to pass through the router from the Internet (IPv4).

Enable IPV6 Multicast Streams: Check the box to allow multicast traffic to pass through the router from the Internet (IPv6).

The screenshot displays the 'Advanced Network Settings' page for a D-Link DIR-865L router. The page is organized into several sections, each with a title and a set of options. The 'UPNP' section has 'Enable UPnP IGD' checked. The 'WAN PING' section has 'Enable WAN Ping Response' unchecked. The 'WAN PORT SPEED' section has 'WAN Port Speed' set to 'Auto 10/100/1000Mbps'. The 'IPV4 MULTICAST STREAMS' section has 'Enable IPv4 Multicast Streams' unchecked. The 'IPV6 MULTICAST STREAMS' section has 'Enable IPv6 Multicast Streams' checked. The page also includes a 'Helpful Hints...' sidebar on the right with several tips related to UPnP, WAN Ping, and WAN Port Speed.

DIR-865L //	SETUP	ADVANCED	TOOLS	STATUS	SUPPORT
VIRTUAL SERVER	ADVANCED NETWORK SETTINGS				Helpful Hints... <ul style="list-style-type: none"> • UPnP helps other UPnP LAN hosts interoperate with the router. Leave the UPnP option enabled as long as the LAN has other UPnP applications. • For added security, it is recommended that you disable the WAN Ping Response option. Ping is often used by malicious Internet users to locate active networks or PCs. • The WAN speed is usually detected automatically. If you are having problems connecting to the WAN, try selecting the speed manually. • If you are having trouble receiving video on demand type of service from the Internet, make sure the Multicast Stream option is enabled. • Energy Efficient Ethernet(EEE), also known as IEEE 802.3az, is a set of enhancements to the twisted-pair and backplane ethernet networking standards that will allow for less power consumption during periods of low data activity. • More...
PORT FORWARDING	These options are for users that wish to change the LAN settings. We do not recommend changing these settings from factory default. Changing these settings may affect the behavior of your network. <input type="button" value="Save Settings"/> <input type="button" value="Don't Save Settings"/>				
APPLICATION RULES	UPNP				
QOS ENGINE	Universal Plug and Play(UPnP) supports peer-to-peer Plug and Play functionality for network devices. Enable UPnP IGD : <input checked="" type="checkbox"/>				
NETWORK FILTER	WAN PING				
ACCESS CONTROL	If you enable this feature, the WAN port of your router will respond to ping requests from the Internet that are sent to the WAN IP Address. Enable WAN Ping Response : <input type="checkbox"/>				
WEBSITE FILTER	WAN PORT SPEED				
INBOUND FILTER	WAN Port Speed : Auto 10/100/1000Mbps <input type="button" value="Save Settings"/> <input type="button" value="Don't Save Settings"/>				
FIREWALL SETTINGS	IPV4 MULTICAST STREAMS				
ROUTING	Enable IPv4 Multicast Streams : <input type="checkbox"/>				
ADVANCED WIRELESS	IPV6 MULTICAST STREAMS				
WI-FI PROTECTED SETUP	Enable IPv6 Multicast Streams : <input checked="" type="checkbox"/> <input type="button" value="Save Settings"/> <input type="button" value="Don't Save Settings"/>				
ADVANCED NETWORK					
DLNA SETTINGS					
ITUNES SERVER					
GUEST ZONE					
IPV6 FIREWALL					
IPV6 ROUTING					

DLNA Settings

DLNA (Digital Living Network Alliance) is the standard for the interoperability of Network Media Devices (NMDs). The user can enjoy multi-media applications (music, pictures and videos) on your network connected PC or media devices. If you agree to share media with devices, any computer or device that connects to your network can play your shared music, pictures and videos.

Note: The shared media may not be secure. Allowing any devices to stream is recommended only on secure networks.

The following parameters will be available for configuration:

Name your media library: Enter the name of your media library here.

This name will be visible to all the DLNA players on the network.

Folder: Simply tick the **root** option, to use the root directory of the storage device plugged into the USB port of the router. To use a specific folder on the storage device, click on the **Browse** button and navigate to the specific folder. Click on the **Apply** button to choose the folder.

Click on the **Save Settings** button to accept the changes made.

Click on the **Don't Save Settings** button to discard the changes made.

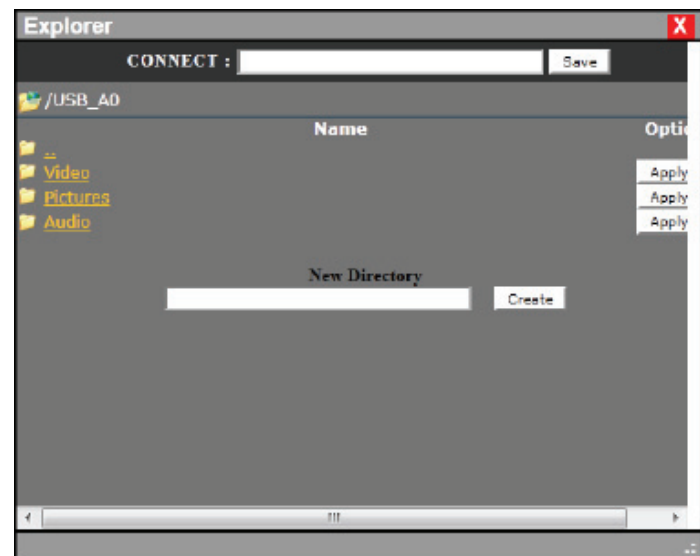
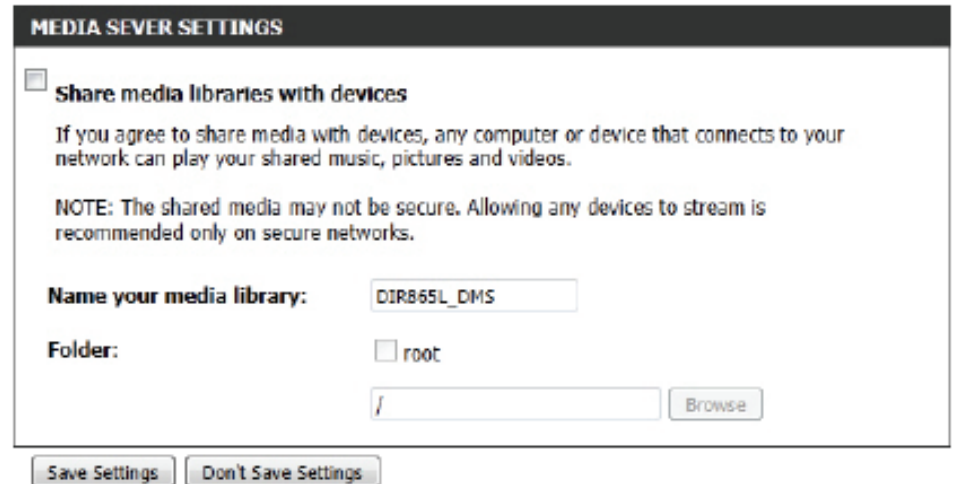
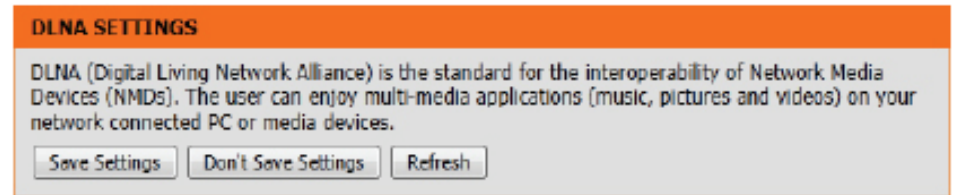

iTunes Server

The router features an iTunes Server. This server provides the ability to share music and videos to computers on the local network running iTunes. If the server is enabled, the router will be automatically detected by the iTunes program and the music and videos contained in the specified directory will be available to stream over the network.

The following parameters will be available for configuration:

iTunes Server: Select to enable or disable the iTunes server.

Folder: Specifies the folder or directory that will be shared by the iTunes server. Select **root** to share all files on all volumes, or click **Browse** to select a specific folder.

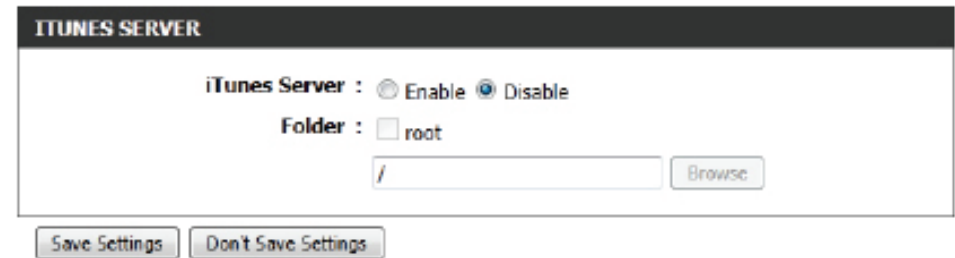
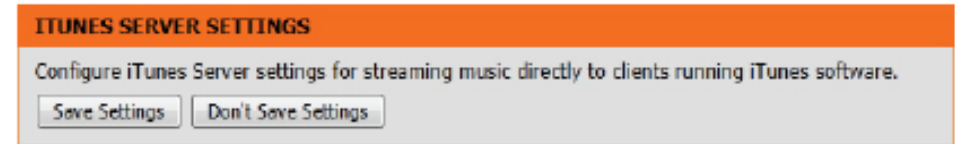

Click on the **Save Settings** button to accept the changes made.

Click on the **Don't Save Settings** button to discard the changes made.

After enabling the iTunes server on the router, launch iTunes. In your iTunes utility, select the router and enter the iTunes server password if required.

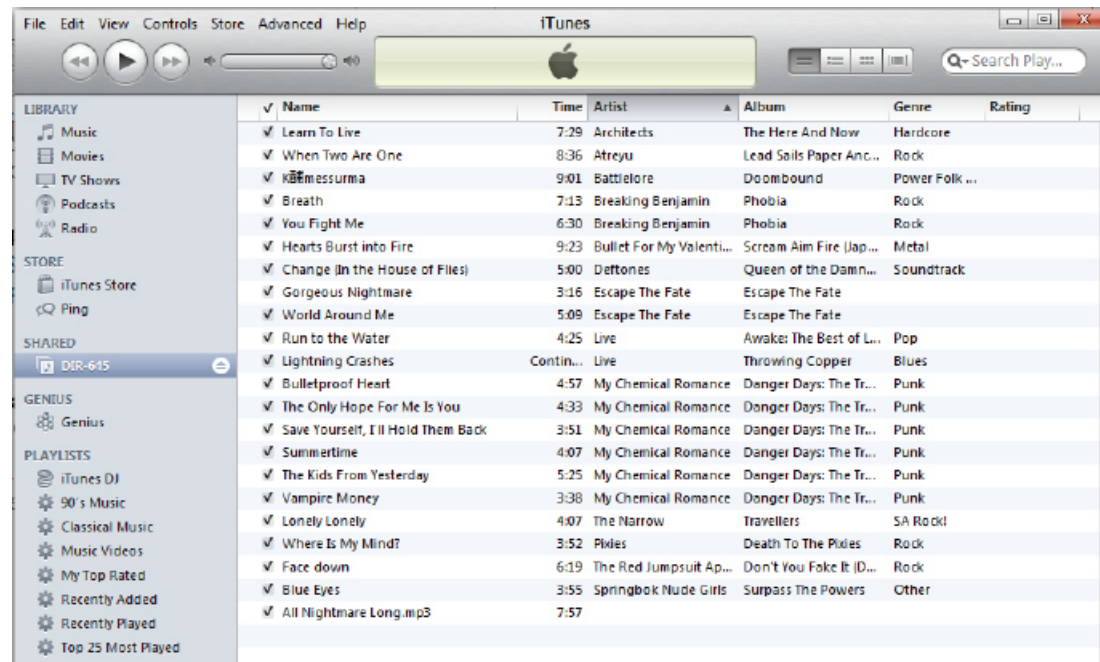

Guest Zone

The Guest Zone feature will allow you to create temporary zones that can be used by guests to access the Internet. These zones will be separate from your main wireless network. You may configure different zones for the 2.4GHz and 5GHz wireless bands.

Enable Guest Zone: Check to enable the Guest Zone feature.

Schedule: The schedule of time when the Guest Zone will be active. The schedule may be set to **Always**, which will allow the particular service to always be enabled. You can create your own times in the **Tools > Schedules** section or click **Add New**.

Wireless Network Name: Enter a wireless network name (SSID) that is different from your main wireless network.

Enable Routing Between Zones: Check to allow network connectivity between the different zones created.

Security Mode: Select the type of security or encryption you would like to enable for the guest zone.

Product Page : DIR-865L Hardware Version : A1 Firmware Version : 1.00

D-Link

DIR-865L // SETUP ADVANCED TOOLS STATUS SUPPORT

GUEST ZONE

Use this section to configure the guest zone settings of your router. The guest zone provide a separate network zone for guest to access Internet.

Save Settings Don't Save Settings

GUEST ZONE

Enable Routing Between Zones

SESSION 2.4GHZ

Enable Guest Zone : Always

Wireless Band : 2.4GHz Band

Wireless Network Name : dlink-guest (Also called the SSID)

Security Mode : None

SESSION 5GHZ

Enable Guest Zone : Always

Wireless Band : 5GHz Band

Wireless Network Name : dlink-media-guest (Also called the SSID)

Security Mode : None

Helpful Hints...

- Use this section to configure the guest zone settings of your router. The guest zone provide a separate network zone for guests to access Internet.
- More...

IPv6 Firewall

The DIR-865L's IPv6 Firewall feature allows you to configure which kind of IPv6 traffic is allowed to pass through the device. The DIR-865L's IPv6 Firewall functions in a similar way to the IP Filters feature.

Enable Checkbox: Check the box to enable the IPv6 firewall simple security.

Configure IPv6 Firewall: Select an action from the drop-down menu.

Name: Enter a name to identify the IPv6 firewall rule.

Schedule: Use the drop-down menu to select the time schedule that the IPv6 Firewall Rule will be enabled on. The schedule may be set to **Always**, which will allow the particular service to always be enabled. You can create your own times in the **Tools > Schedules** section.

Source: Use the **Source** drop-down menu to specify the interface that connects to the source IPv6 addresses of the firewall rule.

IP Address Range: Enter the source IPv6 address range in the adjacent **IP Address Range** field.

Dest: Use the **Dest** drop-down menu to specify the interface that connects to the destination IP addresses of the firewall rule.

Protocol: Select the protocol of the firewall port (**All**, **TCP**, **UDP**, or **ICMP**).

Port Range: Enter the first port of the range that will be used for the firewall rule in the first box and enter the last port in the field in the second box.

Product Page : DIR-865L Hardware Version : A1 Firmware Version : 1.00

D-Link

DIR-865L // SETUP ADVANCED TOOLS STATUS SUPPORT

IPv6 FIREWALL

The firewall settings section is an advance feature used to allow or deny traffic from passing through the device. It works in the same way as IP Filters with additional settings. You can create more detailed rules for the device.

Save Settings Don't Save Settings

20 -- IPv6 FIREWALL RULES

Remaining number of rules that can be created: 20

Configure IPv6 Filtering below:
Turn IPv6 Filtering OFF

Name	Schedule	Source	Interface	IP Address Range	Protocol	Port Range
	Always				All	

Helpful Hints...

- For each rule you can create a name and control the direction of traffic. You can also allow or deny a range of IP Addresses, the protocol and a port range.
- In order to apply a schedule to a Firewall rule, you must first define a schedule on the [Tools -> Schedules](#) page.
- [More...](#)

IPv6 Routing

This page allows you to specify custom routes that determine how data is moved around your network.

Route List: Check the box next to the route you wish to enable.

Name: Enter a specific name to identify this route.

Destination IP/Prefix Length: This is the IP address of the router used to reach the specified destination or enter the IPv6 address prefix length of the packets that will take this route.

Metric: Enter the metric value for this rule here.

Interface: Use the drop-down menu to specify if the IP packet must use the WAN or LAN interface to transit out of the Router.

Gateway: Enter the next hop that will be taken if this route is used.

Product Page : DIR-865L Hardware Version : A1 Firmware Version : 1.00

D-Link

DIR-865L // SETUP ADVANCED TOOLS STATUS SUPPORT

ROUTING

This Routing page allows you to specify custom routes that determine how data is moved around your network.

Save Settings Don't Save Settings

10 -- ROUTE LIST

Name	Destination IPv6 / Prefix Length	Metric	Interface	Gateway
<input type="checkbox"/>	/	64	NULL	
<input type="checkbox"/>	/	64	NULL	
<input type="checkbox"/>	/		NULL	

Helpful Hints...

- Each route has a check box next to it, check this box if you want the route to be enabled.
- The name field allows you to specify a name for identification of this route, e.g. 'Network 2'
- The destination IPv6 address is the address of the host or network you wish to reach.
- The prefix length field identifies the portion of the destination IP in use.
- The gateway IP address is the IP address of the router, if any, used to reach the specified destination.
- [More...](#)

Tools Admin

This page will allow you to change the Administrator and User passwords. You can also enable Remote Management. There are two accounts that can access the management interface through the web browser. The accounts are admin and user. Admin has read/write access while user has read-only access. User can only view the settings but cannot make any changes. Only the admin account has the ability to change both admin and user account passwords.

Admin Password: Enter a new password for the Administrator Login Name. The administrator can make changes to the settings.

User Password: Enter the new password for the User login. If you login as the User, you cannot change the settings (you can only view them).

Gateway name: Enter a name for your router.

Enable Graphical Authentication: Enables a challenge-response test to require users to type letters or numbers from a distorted image displayed on the screen to prevent online hackers and unauthorized users from gaining access to your router's network settings.

Enable HTTPS Server: Check to enable HTTPS to connect to the router securely. This means to connect to the router, you must enter **https://192.168.0.1** (for example) instead of **http://192.168.0.1**.

Enable Remote Management: Remote management allows the DIR-865L to be configured from the Internet by a web browser. A username/password is still required to access the Web Management interface.

Remote Admin Port: The port number used to access the DIR-865L is used in the URL. Example: **http://x.x.x.x:8080** whereas x.x.x.x is the Internet IP address of the DIR-865L and 8080 is the port used for the Web Management interface.

If you have enabled **HTTPS Server**, you must enter **https://** as part of the URL to access the router remotely.

Remote Admin Inbound Filter: This section will list any rules that are created. You may click the **Edit** icon to change the settings or enable/disable the rule, or click the **Delete** icon to remove the rule. **Details** will display the current status.

The screenshot shows the D-Link DIR-865L web management interface. The top navigation bar includes 'DIR-865L', 'SETUP', 'ADVANCED', 'TOOLS', 'STATUS', and 'SUPPORT'. The 'TOOLS' tab is selected, and the 'ADMIN' sub-tab is active. The main content area is titled 'ADMINISTRATOR SETTINGS' and contains the following sections:

- ADMINISTRATOR SETTINGS:** A warning message states: "The 'admin' account can access the management interface. The admin has read/write access and can change password. By default there is no password configured. It is highly recommended that you create a password to keep your router secure." Below this are 'Save Settings' and 'Don't Save Settings' buttons.
- ADMIN PASSWORD:** A message says "Please enter the same password into both boxes, for confirmation." There are two password input fields labeled 'Password' and 'Verify Password'.
- SYSTEM NAME:** A 'Gateway Name' field with the value 'DIR-865L'.
- ADMINISTRATION:** A list of settings:
 - Enable Graphical Authentication:
 - Enable HTTPS Server:
 - Enable Remote Management:
 - Remote Admin Port: 8080 Use HTTPS:
 - Remote Admin Inbound Filter: Allow All (dropdown menu)
 - Details: Allow All (text field)

At the bottom of the ADMINISTRATION section are 'Save Settings' and 'Don't Save Settings' buttons. On the right side, there is a 'Helpful Hints...' section with several bullet points providing security and configuration advice.

Time

The Time Configuration option allows you to configure, update, and maintain the correct time on the internal system clock. From this section you can set the time zone that you are in and set the Time Server. Daylight Saving can also be configured to automatically adjust the time when needed.

Time: Displays the current date and time of the router.

Time Zone: Select your Time Zone from the drop-down menu.

Enable Daylight Saving: To select Daylight Saving time manually, select enabled or disabled, and enter a start date and an end date for daylight saving time.

Enable NTP Server: NTP is short for Network Time Protocol. A NTP server will synch the time and date with your router. This will only connect to a server on the Internet, not a local server. Check the box to enable this feature.

NTP Server Used: Enter the IP address of a NTP server or select one from the drop-down menu.

Manual: To manually input the time, enter the values in these fields for the Year, Month, Day, Hour, Minute, and Second and then click **Set Time**.

You can also click **Copy Your Computer's Time Settings** to synch the date and time with the computer you are currently on.

The screenshot shows the D-Link web interface for the DIR-865L router. The main navigation bar includes 'DIR-865L', 'SETUP', 'ADVANCED', 'TOOLS', 'STATUS', and 'SUPPORT'. The left sidebar lists various configuration categories: ADMIN, TIME, SYSLOG, EMAIL SETTINGS, SYSTEM, FIRMWARE, DYNAMIC DNS, SYSTEM CHECK, and SCHEDULES. The main content area is titled 'TIME AND DATE' and contains the following sections:

- TIME AND DATE:** A summary box explaining the configuration options and providing 'Save Settings' and 'Don't Save Settings' buttons.
- TIME AND DATE CONFIGURATION:**
 - Time: 01/01/2000 01:03:11
 - Time Zone: (GMT+08:00) Taipei
 - Enable Daylight Saving:
 - Daylight Saving Offset: +01:00
 - Daylight Saving Dates:

DST Start	Month	Week	Day of Week	Time
Jan	1st	Sun	12:00 AM	
DST End	Jan	1st	Sun	12:00 AM
- AUTOMATIC TIME AND DATE CONFIGURATION:**
 - Automatically synchronize with D-Link's Internet time server
 - NTP Server Used: ntp1.dlink.com
 - Update Now button
- SET THE TIME AND DATE MANUALLY:**

Year	2009	Month	Jan	Day	1
Hour	1	Minute	3	Second	11

On the right side of the interface, there is a 'Helpful Hints...' section with a bullet point: 'Either enter the time manually by clicking the Sync Your Computers Time Settings button, or use the Automatic Time Configuration option to have your router synchronize with a time server on the Internet.' A 'More...' link is also present.

SysLog

The Broadband Router keeps a running log of events and activities occurring on the Router. You may send these logs to a SysLog server on your network.

Enable Logging to SysLog Server: Check this box to send the router logs to a SysLog Server.

SysLog Server IP Address: The address of the SysLog server that will be used to send the logs. You may also select your computer from the drop-down menu (only if receiving an IP address from the router via DHCP).

The screenshot shows the D-Link web interface for the DIR-865L router. At the top, it displays 'Product Page : DIR-865L', 'Hardware Version : A1', and 'Firmware Version : 1.00'. The D-Link logo is prominently displayed. Below the logo is a navigation menu with tabs for 'DIR-865L', 'SETUP', 'ADVANCED', 'TOOLS', 'STATUS', and 'SUPPORT'. The 'TOOLS' tab is selected, and the 'SYSLOG' sub-tab is active. The main content area is titled 'SYSLOG' and contains the following text: 'The SysLog options allow you to send log information to a Syslog Server.' Below this text are two buttons: 'Save Settings' and 'Don't Save Settings'. Underneath, there is a section titled 'SYSLOG SETTINGS' with the option 'Enable Logging To SysLog : Server' which is currently unchecked. This option also has 'Save Settings' and 'Don't Save Settings' buttons. On the right side of the interface, there is a 'Helpful Hints...' section with a bullet point explaining that a System Logger (syslog) is a server that collects logs from different sources and that if the LAN includes a syslog server, the router's logs can be sent to that server. A 'More...' link is provided at the end of the hint.

Email Settings

The Email feature can be used to send the system log files, router alert messages, and firmware update notification to your email address.

Enable Email Notification: When this option is enabled, router activity logs are emailed to a designated email address.

From Email Address: This email address will appear as the sender when you receive a log file or firmware upgrade notification via email.

To Email Address: Enter the email address where you want the email sent.

SMTP Server Address: Enter the SMTP server address for sending email.

SMTP Server Port: Enter the SMTP port used on the server.

Enable Authentication: Check this box if your SMTP server requires authentication.

Account Name: Enter your account for sending email.

Password: Enter the password associated with the account. Re-type the password associated with the account.

On Log Full: When this option is selected, logs will be sent via email to your account when the log is full.

On Schedule: Selecting this option will send the logs via email according to schedule.

Schedule: This option is enabled when **On Schedule** is selected. You can select a schedule from the list of defined schedules. To create a schedule, go to **Tools > Schedules**.

The screenshot shows the D-Link DIR-865L web interface. The top navigation bar includes 'DIR-865L //', 'SETUP', 'ADVANCED', 'TOOLS', 'STATUS', and 'SUPPORT'. The left sidebar lists menu items: ADMIN, TIME, SYSLOG, EMAIL SETTINGS (highlighted), SYSTEM, FIRMWARE, DYNAMIC DNS, SYSTEM CHECK, and SCHEDULES. The main content area is titled 'EMAIL SETTINGS' and contains the following sections:

- EMAIL SETTINGS:** A introductory message: "The Email feature can be used to send the system log files, router alert messages, and firmware update notification to your email address." Below this are 'Save Settings' and 'Don't Save Settings' buttons.
- EMAIL NOTIFICATION:** A section with the label 'Enable Email Notification :
- EMAIL SETTINGS:** A form with the following fields:
 - From Email Address :
 - To Email Address :
 - Email Subject :
 - SMTP Server Address :
 - SMTP Server Port :
 - Enable Authentication :
 - Account Name :
 - Password :
 - Verify Password :
- EMAIL LOG WHEN FULL OR ON SCHEDULE:** A section with the following options:
 - On Log Full :
 - On Schedule :
 - Schedule :
 - Detail :

At the bottom of the form are 'Save Settings' and 'Don't Save Settings' buttons. On the right side, there is a 'Helpful Hints...' section with a bullet point: "You may want to make the email settings similar to those of your email client program." and a 'More...' link.

System

This section allows you to manage the router's configuration settings, reboot the router, and restore the router to the factory default settings. Restoring the unit to the factory default settings will erase all settings, including any rules that you've created.

Save Settings to Local Hard Drive: Use this option to save the current router configuration settings to a file on the hard disk of the computer you are using. First, click the **Save** button. A file dialog will appear, allowing you to select a location and file name for the settings.

Load Settings from Local Hard Drive: Use this option to load previously saved router configuration settings. First, use the **Browse** option to find a previously saved file of configuration settings. Then, click the **Load** button to transfer those settings to the router.

Restore to Factory Default Settings: This option will restore all configuration settings back to the settings that were in effect at the time the router was shipped from the factory. Any settings that have not been saved will be lost, including any rules that you have created. If you want to save the current router configuration settings, use the **Save** button above.

Reboot Device: Click to reboot the router.

The screenshot shows the D-Link DIR-865L web interface. At the top, it displays 'Product Page : DIR-865L', 'Hardware Version : A1', and 'Firmware Version : 1.00'. The D-Link logo is prominently displayed. Below the logo is a navigation menu with tabs for 'DIR-865L //', 'SETUP', 'ADVANCED', 'TOOLS', 'STATUS', and 'SUPPORT'. The 'TOOLS' tab is selected, leading to the 'SAVE AND RESTORE SETTINGS' page. The page contains the following text and buttons:

SAVE AND RESTORE SETTINGS

Once the router is configured you can save the configuration settings to a configuration file on your hard drive. You also have the option to load configuration settings, or restore the factory default settings.

SAVE AND RESTORE SETTINGS

Save Settings To Local Hard Drive :

Load Settings From Local Hard Drive :

Restore To Factory Default Settings :

Reboot The Device :

Clear Language Pack :

Helpful Hints...

- Once your router is configured the way you want it, you can save these settings to a configuration file that can later be loaded in the event that the router's default settings are restored. To do this, click the **Save** button next to where it says Save Settings to Local Hard Drive.
- [More...](#)

Firmware

You can upgrade the firmware of the access point here. Make sure the firmware you want to use is on the local hard drive of the computer. Click on **Browse** to locate the firmware file to be used for the update. Please check the D-Link support website for firmware updates at <http://support.dlink.com>. You can download firmware upgrades to your hard drive from this site.

Browse: After you have downloaded the new firmware, click **Browse** to locate the firmware update on your hard drive. Click **Upload** to complete the firmware upgrade.

Upload: Once you have a firmware update on your computer, use this option to browse for the file and then upload the information into the access point.

Language Pack

You can change the language of the web UI by uploading available language packs.

Browse: After you have downloaded the new language pack, click **Browse** to locate the language pack file on your hard drive. Click **Upload** to complete the language pack upgrade.

The screenshot displays the D-Link web management interface for a DIR-865L router. At the top, it shows 'Product Page : DIR-865L', 'Hardware Version : A1', and 'Firmware Version : 1.00'. The main navigation bar includes 'D-Link', 'DIR-865L //', and tabs for 'SETUP', 'ADVANCED', 'TOOLS', 'STATUS', and 'SUPPORT'. A left sidebar lists menu items: ADMIN, TIME, SYSLOG, EMAIL SETTINGS, SYSTEM, FIRMWARE, DYNAMIC DNS, SYSTEM CHECK, and SCHEDULES. The 'FIRMWARE' section is active, showing a 'FIRMWARE UPDATE' notice with instructions to locate the file and click 'Upload'. Below this is 'FIRMWARE INFORMATION' showing 'Current Firmware Version : 1.00' and 'Current Firmware Date : Wed 23 May 2012', with a 'Check Online Now for Latest : Firmware Version' button. The 'FIRMWARE UPGRADE' section contains a red warning note: 'Note: Some firmware upgrades reset the configuration options to the factory defaults. Before performing an upgrade, be sure to save the current configuration.' It also states: 'To upgrade the firmware, your PC must have a wired connection to the router. Enter the name of the firmware upgrade file, and click on the Upload button.' There are two 'Upload' buttons, each with a 'Browse...' button next to it. The bottom section is 'LANGUAGE PACK UPGRADE', which also has an 'Upload' button and a 'Browse...' button.

Dynamic DNS

The DDNS feature allows you to host a server (Web, FTP, Game Server, etc...) using a domain name that you have purchased (www.whateveryournameis.com) with your dynamically assigned IP address. Most broadband Internet Service Providers assign dynamic (changing) IP addresses. Using a DDNS service provider, your friends can enter in your domain name to connect to your server no matter what your IP address is.

Enable Dynamic Domain Name System is a method of **Dynamic DNS:** keeping a domain name linked to a changing IP Address. Check the box to enable DDNS.

Server Address: Select your DDNS provider from the drop-down menu or enter the DDNS server address.

Host Name: Enter the Host Name that you registered with your DDNS service provider.

Username or Key: Enter the Username or key for your DDNS account.

Password or Key: Enter the Password or key for your DDNS account.

Timeout: Enter a timeout time (in hours).

Status: Displays the current connection status.

D-Link

DIR-865L // SETUP ADVANCED TOOLS STATUS SUPPORT

DYNAMIC DNS

The Dynamic DNS feature allows you to host a server (Web, FTP, Game Server, etc...) using a domain name that you have purchased (www.whateveryournameis.com) with your dynamically assigned IP address. Most broadband Internet Service Providers assign dynamic (changing) IP addresses. Using a DDNS service provider, your friends can enter your host name to connect to your game server no matter what your IP address is.

[Sign up for D-Link's Free DDNS service at www.DLinkDDNS.com.](#)

Save Settings Don't Save Settings

DYNAMIC DNS SETTINGS

Enable Dynamic DNS :

Server Address :

Host Name :

Username or Key :

Password or Key :

Verify Password or Key :

Timeout : 367 (hours)

Status : Disconnected

DYNAMIC DNS FOR IPV6 HOSTS

Enable :

IPv6 Address : Computer Name

Host Name : (e.g.: ipv6.mydomain.net)

Save Clear

IPV6 DYNAMIC DNS LIST

Enable	Host Name	IPv6 Address
<input type="checkbox"/>		

Helpful Hints...

- To use this feature, you must first have a Dynamic DNS account from one of the providers in the drop down menu.
- We could also use DDNS function for IPv6 with the same account as IPv4.
- More...

System Check

Ping Test: The Ping Test is used to send Ping packets to test if a computer is on the Internet. Enter the IP address that you wish to Ping and click **Ping**.

IPv6 Ping Test: Enter the IPv6 address that you wish to Ping and click **Ping**.

Ping Results: The results of your ping attempts will be displayed here.

The screenshot shows the D-Link DIR-826L web interface. The top navigation bar includes 'D-Link', 'DIR-826L //', and tabs for 'SETUP', 'ADVANCED', 'TOOLS', 'STATUS', and 'SUPPORT'. The left sidebar lists various configuration options: ADMIN, TIME, SYSLOG, EMAIL SETTINGS, SYSTEM, FIRMWARE, DYNAMIC DNS, SYSTEM CHECK, and SCHEDULES. The main content area is divided into three sections: 'PING TEST', 'IPv6 PING TEST', and 'PING RESULT'. The 'PING TEST' section contains a text box for 'Host Name or IP Address' and 'Ping'/'Stop' buttons. The 'IPv6 PING TEST' section contains a text box for 'Host Name or IPv6 Address' and 'Ping'/'Stop' buttons. The 'PING RESULT' section contains a text box with the instruction 'Enter a host name or IP address above and click 'Ping''. On the right side, there is a 'Helpful Hints ...' section with text explaining the ping test and a 'More...' link. The bottom of the interface features the 'WIRELESS' logo.

Schedules

Schedules can be created for use with enforcing rules. For example, if you want to restrict web access to Mon-Fri from 3pm to 8pm, you could create a schedule selecting Mon, Tue, Wed, Thu, and Fri and enter a Start Time of 3pm and End Time of 8pm.

Name: Enter a name for your new schedule.

Days: Select a day, a range of days, or All Week to include every day.

Time: Check **All Day - 24hrs** or enter a start and end time for your schedule.

Save: You must click **Save Settings** at the top for your schedules to go into effect.

Schedule Rules The list of schedules will be listed here. Click the **List:** **Edit** icon to make changes or click the **Delete** icon to remove the schedule.

D-Link

DIR-865L //

SETUP ADVANCED TOOLS STATUS SUPPORT

SCHEDULES

The Schedule configuration option is used to manage schedule rules for "WAN", "Wireless", "Virtual Server", "Port Forwarding", "Applications" and "Network Filter".

10 -- ADD SCHEDULE RULE

Name :

Day(s) : All Week Select Day(s)

Sun Mon Tue Wed Thu Fri Sat

All Day - 24 hrs :

Time Format :

Start Time : : : 0 (hour:minute)

End Time : : : 59 (hour:minute)

SCHEDULE RULES LIST

Name	Day(s)	Time Frame

Helpful Hints...

- Schedules are used with a number of other features to define when those features are in effect.
- Give each schedule a name that is meaningful to you. For example, a schedule for Monday through Friday from 3:00pm to 9:00pm, might be called "After School".
- Click **Add** to add a completed schedule to the list below.
- Click **Edit** icon to change an existing schedule.
- Click **Delete** icon to permanently delete a schedule.
- [More...](#)

Status

Device Info

This page displays the current information for the DIR-865L. It will display the LAN, WAN (Internet), and Wireless information. If your Internet connection is set up for a Dynamic IP address then a **Release** button and a **Renew** button will be displayed. Use **Release** to disconnect from your ISP and use **Renew** to connect to your ISP.

If your Internet connection is set up for PPPoE, a **Connect** button and a **Disconnect** button will be displayed. Use **Disconnect** to drop the PPPoE connection and use **Connect** to establish the PPPoE connection.

General: Displays the router's time and firmware version.

WAN: Displays the MAC address and the public IP settings

LAN: Displays the MAC address and the private (local) IP settings for the router.

Wireless LAN1: Displays the 2.4GHz wireless MAC address and your wireless settings such as SSID and Channel.

Wireless LAN2: Displays the 5GHz wireless MAC address and your wireless settings such as SSID and Channel.

LAN Computers: Displays computers and devices that are connected to the router via Ethernet and that are receiving an IP address assigned by the router (DHCP).

D-Link

DIR-865L // SETUP ADVANCED TOOLS STATUS SUPPORT

DEVICE INFORMATION
All of your Internet and network connection details are displayed on this page. The firmware version is also displayed here.

GENERAL
Time : Sunday, January 02, 2011 12:45:08 AM
Firmware Version : 1.00 , Tue, 16, Mar, 2010

WAN
Connection Type : Dynamic IP (DHCP)
Cable Status : Disconnected
Network Status : Disconnected
Connection Up Time : N/A
MAC Address : 00:18:E7:95:70:A1
IP Address : 0.0.0.0
Subnet Mask : 0.0.0.0
Default Gateway : 0.0.0.0
Primary DNS Server : 0.0.0.0
Secondary DNS Server : 0.0.0.0
Advanced DNS : Disabled

LAN
MAC Address : 00:18:E7:95:70:A0
IP Address : 192.168.0.1
Subnet Mask : 255.255.255.0
DHCP Server : Enabled

WIRELESS LAN1
Wireless Band: 2.4GHz
Wireless Radio: Enable
802.11 Mode: 802.11bgn
Channel Width: 20/40MHz
Channel: 2
Wi-Fi Protected Setup: Enabled/Not Configured
SSID List:
Network Name (SSID) Guest MAC Address Security Mode
dlink No 00:18:E7:95:70:A0 Off

WIRELESS LAN2
Wireless Band: 5GHz Band
Wireless Radio: Enable
802.11 Mode: 802.11n
Channel Width: 20/40MHz
Channel: 36
Wi-Fi Protected Setup: Enabled/Not Configured
SSID List:
Network Name (SSID) Guest MAC Address Security Mode
dlink_media No 00:18:E7:95:70:A2 Off

LAN COMPUTERS
IP Address Name (if any) MAC
192.168.0.100 PM_test01 00:04:23:2C:51:A3

IGMP MULTICAST MEMBERSHIPS
Multicast Group Address

WIRELESS

Logs

The router automatically logs (records) events of possible interest in its internal memory. If there isn't enough internal memory for all events, logs of older events are deleted but logs of the latest events are retained. The Logs option allows you to view the router logs. You can define what types of events you want to view and the level of the events to view. This router also has external Syslog Server support so you can send the log files to a computer on your network that is running a Syslog utility.

Log Options: You can select the types of messages that you want to display from the log. System Activity, Debug Information, Attacks, Dropped Packets, and Notice messages can be selected. Click **Apply Log Settings Now** to activate your settings.

Refresh: Updates the log details on the screen so it displays any recent activity.

First Page: Click to go to the first page.

Last Page: Click to go to the last page.

Previous: Click to go back one page.

Next: Click to go to the next page.

Clear: Clears all of the log contents.

Email Now: This option will send a copy of the router log to your email address configured in the **Tools > Email Settings** screen.

Save Log: This option will save the router log to a file on your computer.

D-Link

DIR-826L

SETUP ADVANCED TOOLS STATUS SUPPORT

DEVICE INFO
LOGS
STATISTICS
INTERNET SESSIONS
ROUTING
WIRELESS
IPv6
IPv6 ROUTING

LOGS

Use this option to view the router logs. You can define what types of events you want to view and the event levels to view. This router also has internal syslog server support so you can send the log files to a computer on your network that is running a syslog utility.

LOG OPTIONS

Log Options : System Activity
 Debug Information
 Attacks
 Dropped Packets
 Notice

Apply Log Settings Now

LOG DETAILS

First Page Last Page Previous Next
Refresh Clear Email Now Save Log

1/9

Time	Message
Jan 1 00:19:32	cron.err: crond[11725]: crond (busybox 1.12.1) started, log level 8
Jan 1 00:19:31	cron.err: crond[11673]: crond (busybox 1.12.1) started, log level 8
Jan 1 00:19:30	cron.err: crond[11557]: crond (busybox 1.12.1) started, log level 8
Jan 1 00:19:30	cron.err: crond[11349]: crond (busybox 1.12.1) started, log level 8
Jan 1 00:19:30	user.crit: kernel: Argh. No free space left for GC. nr_erasing_blocks is 0. nr_free_blocks is 0. (erasableempty: yes, erasingempty: yes, erasependingempty: yes)
Jan 1 00:00:24	user.info: kernel: br0: port 2(ra00_0) entering forwarding state
Jan 1 00:00:13	user.info: kernel: br0: port 2(ra00_0) entering learning state
Jan 1 00:00:13	user.info: kernel: br0: port 2(ra00_0) entering learning state
Jan 1 00:00:13	user.info: kernel: device ra00_0 entered promiscuous mode
Jan 1 00:00:13	user.warn: kernel: 0x1300 = 00064380

Helpful Hints...
Check the log frequently to detect unauthorized network usage.
You can also have the log mailed to you periodically. Refer to [Tools -> Email](#).
More...

WIRELESS

Statistics

The screen below displays the **Traffic Statistics**. Here you can view the amount of packets that pass through the DIR-865L on both the WAN, LAN ports and the wireless segments. The traffic counter will reset if the device is rebooted.

D-Link

DIR-826L //

SETUP ADVANCED TOOLS STATUS SUPPORT

DEVICES INFO
LOGS
STATISTICS
INTERNET SESSIONS
ROUTING
WIRELESS
IPV6
IPV6 ROUTING

TRAFFIC STATISTICS
Traffic Statistics display Receive and Transmit packets passing through your router.
Refresh Statistics Clear Statistics

LAN STATISTICS

Sent : 133656	Received : 28232
TX Packets : 0	RX Packets : 0
Dropped : 0	Dropped : 0
Collisions : 0	Errors : 0

WAN STATISTICS

Sent : 66	Received : 0
TX Packets : 0	RX Packets : 0
Dropped : 0	Dropped : 0
Collisions : 0	Errors : 0

WIRELESS STATISTICS

Sent : 17694	Received : 484764
TX Packets : 0	RX Packets : 0
Dropped : 0	Dropped : 0
	Errors : 0

WIRELESS STATISTICS2

Sent : 11865	Received : 7405
TX Packets : 0	RX Packets : 0
Dropped : 0	Dropped : 0
	Errors : 0

Helpful Hints...
This is a summary of the number of packets that have passed between the WAN and the LAN since the router was last initialized.
[More...](#)

WIRELESS

Internet Sessions

The Internet Sessions page displays full details of active Internet sessions through your router. An Internet session is a conversation between a program or application on a LAN-side computer and a program or application on a WAN-side computer.

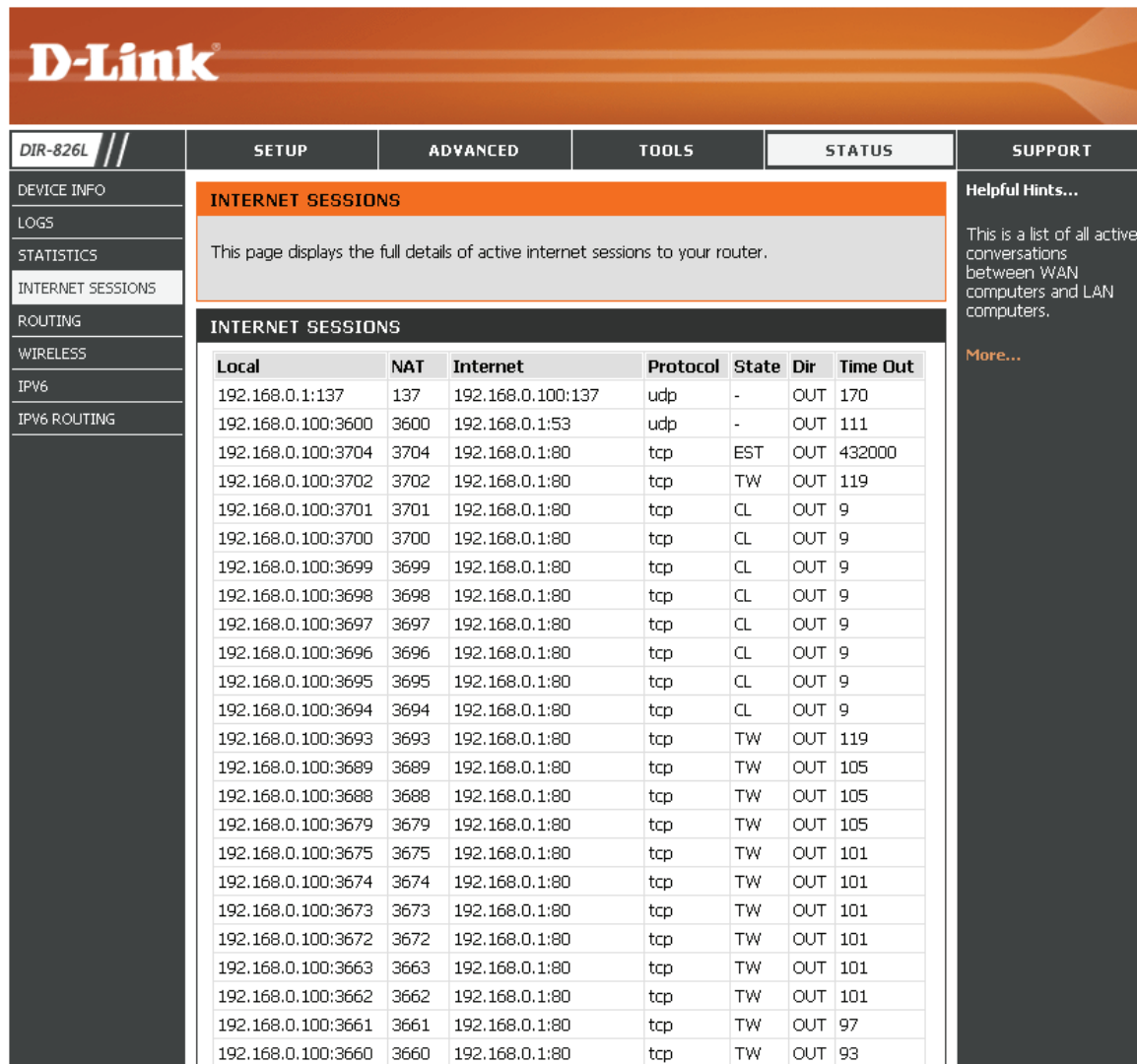

D-Link

DIR-826L //

SETUP ADVANCED TOOLS STATUS SUPPORT

DEVICE INFO
LOGS
STATISTICS
INTERNET SESSIONS
ROUTING
WIRELESS
IPV6
IPV6 ROUTING

INTERNET SESSIONS

This page displays the full details of active internet sessions to your router.

Helpful Hints...
This is a list of all active conversations between WAN computers and LAN computers.
[More...](#)

Local	NAT	Internet	Protocol	State	Dir	Time Out
192.168.0.1:137	137	192.168.0.100:137	udp	-	OUT	170
192.168.0.100:3600	3600	192.168.0.1:53	udp	-	OUT	111
192.168.0.100:3704	3704	192.168.0.1:80	tcp	EST	OUT	432000
192.168.0.100:3702	3702	192.168.0.1:80	tcp	TW	OUT	119
192.168.0.100:3701	3701	192.168.0.1:80	tcp	CL	OUT	9
192.168.0.100:3700	3700	192.168.0.1:80	tcp	CL	OUT	9
192.168.0.100:3699	3699	192.168.0.1:80	tcp	CL	OUT	9
192.168.0.100:3698	3698	192.168.0.1:80	tcp	CL	OUT	9
192.168.0.100:3697	3697	192.168.0.1:80	tcp	CL	OUT	9
192.168.0.100:3696	3696	192.168.0.1:80	tcp	CL	OUT	9
192.168.0.100:3695	3695	192.168.0.1:80	tcp	CL	OUT	9
192.168.0.100:3694	3694	192.168.0.1:80	tcp	CL	OUT	9
192.168.0.100:3693	3693	192.168.0.1:80	tcp	TW	OUT	119
192.168.0.100:3689	3689	192.168.0.1:80	tcp	TW	OUT	105
192.168.0.100:3688	3688	192.168.0.1:80	tcp	TW	OUT	105
192.168.0.100:3679	3679	192.168.0.1:80	tcp	TW	OUT	105
192.168.0.100:3675	3675	192.168.0.1:80	tcp	TW	OUT	101
192.168.0.100:3674	3674	192.168.0.1:80	tcp	TW	OUT	101
192.168.0.100:3673	3673	192.168.0.1:80	tcp	TW	OUT	101
192.168.0.100:3672	3672	192.168.0.1:80	tcp	TW	OUT	101
192.168.0.100:3663	3663	192.168.0.1:80	tcp	TW	OUT	101
192.168.0.100:3662	3662	192.168.0.1:80	tcp	TW	OUT	101
192.168.0.100:3661	3661	192.168.0.1:80	tcp	TW	OUT	97
192.168.0.100:3660	3660	192.168.0.1:80	tcp	TW	OUT	93

Routing

This page will display your current routing table.

Product Page : DIR-865L Hardware Version : A1 Firmware Version : 1.00



DIR-865L // SETUP ADVANCED TOOLS STATUS SUPPORT

DEVICE INFO LOGS STATISTICS INTERNET SESSIONS WIRELESS ROUTING IPv6 IPV6 ROUTING

ROUTING

Routing Table
This page displays the routing details configured for your router.

ROUTING TABLE

Destination	Gateway	Genmask	Metric	Iface	Creator
192.168.7.0	0.0.0.0	255.255.255.0	0	LAN	SYSTEM
192.168.0.0	0.0.0.0	255.255.255.0	0	LAN	SYSTEM
239.0.0.0	0.0.0.0	255.0.0.0	0	LAN	SYSTEM

Helpful Hints...

- This is a list of all routing rules on router.
- [More...](#)

WIRELESS

Wireless

The wireless client table displays a list of current connected wireless clients. This table also displays the connection time and MAC address of the connected wireless clients.

Product Page : DIR-865L Hardware Version : A1 Firmware Version : 1.00



DIR-865L ///	SETUP	ADVANCED	TOOLS	STATUS	SUPPORT										
DEVICE INFO	CONNECTED WIRELESS CLIENT LIST View the wireless clients that are connected to the router. (A client might linger in the list for a few minutes after an unexpected disconnect.)				Helpful Hints... <ul style="list-style-type: none"> This is a list of all wireless clients that are currently connected to your wireless router. More... 										
LOGS															
STATISTICS	NUMBER OF WIRELESS CLIENTS - 2.4GHZ BAND : 0														
INTERNET SESSIONS	<table border="1"> <thead> <tr> <th>MAC Address</th> <th>IP Address</th> <th>Mode</th> <th>Rate (Mbps)</th> <th>Signal (%)</th> </tr> </thead> <tbody> <tr> <td> </td> <td> </td> <td> </td> <td> </td> <td> </td> </tr> </tbody> </table>				MAC Address	IP Address	Mode	Rate (Mbps)	Signal (%)						
MAC Address	IP Address	Mode	Rate (Mbps)	Signal (%)											
WIRELESS	NUMBER OF WIRELESS CLIENTS - 5GHZ BAND : 0														
ROUTING	<table border="1"> <thead> <tr> <th>MAC Address</th> <th>IP Address</th> <th>Mode</th> <th>Rate (Mbps)</th> <th>Signal (%)</th> </tr> </thead> <tbody> <tr> <td> </td> <td> </td> <td> </td> <td> </td> <td> </td> </tr> </tbody> </table>				MAC Address	IP Address	Mode	Rate (Mbps)	Signal (%)						
MAC Address	IP Address	Mode	Rate (Mbps)	Signal (%)											
IPv6															
IPv6 ROUTING															

WIRELESS

IPv6

The IPv6 page displays a summary of the Router's IPv6 settings and lists the IPv6 address and host name of any IPv6 clients.

Product Page : DIR-865L		Hardware Version : A1		Firmware Version : 1.00				
D-Link								
DIR-865L //		SETUP	ADVANCED	TOOLS	STATUS	SUPPORT		
DEVICE INFO	IPv6 NETWORK INFORMATION				Helpful Hints... <ul style="list-style-type: none"> All of your WAN and LAN connection details are displayed here. More... 			
LOGS	All of your Internet and network connection details are displayed on this page. The firmware version is also displayed here.							
STATISTICS	IPv6 CONNECTION INFORMATION							
INTERNET SESSIONS	IPv6 Connection Type : Link-Local IPv6 Default Gateway : None LAN IPv6 Link-Local Address : fe80::bef6:85ff:fed2:4a35 /64							
WIRELESS	LAN IPv6 COMPUTERS							
ROUTING	<table border="1"> <thead> <tr> <th>IPv6 Address</th> <th>Name(if any)</th> </tr> </thead> <tbody> <tr> <td> </td> <td> </td> </tr> </tbody> </table>					IPv6 Address	Name(if any)	
IPv6 Address	Name(if any)							
IPv6	WIRELESS							
IPv6 ROUTING								

IPv6 Routing

This page displays the IPv6 routing details configured for your router.

D-Link

DIR-826L //

SETUP ADVANCED TOOLS STATUS SUPPORT

DEVICE INFO
LOGS
STATISTICS
INTERNET SESSIONS
ROUTING
WIRELESS
IPv6
IPv6 Routing

IPv6 ROUTING

IPv6 Routing Table

This page displays the routing details configured for your router.

IPv6 ROUTING TABLE

Destination IP	Gateway	Metric	Interface
----------------	---------	--------	-----------

More...

WIRELESS

Support

D-Link

DIR-826L //	SETUP	ADVANCED	TOOLS	STATUS	SUPPORT
<div style="background-color: #34495e; color: white; padding: 2px; text-align: center;">MENU</div> <div style="background-color: #34495e; color: white; padding: 2px; text-align: center;">SETUP</div> <div style="background-color: #34495e; color: white; padding: 2px; text-align: center;">ADVANCED</div> <div style="background-color: #34495e; color: white; padding: 2px; text-align: center;">TOOLS</div> <div style="background-color: #34495e; color: white; padding: 2px; text-align: center;">STATUS</div>	<div style="background-color: #e67e22; color: white; padding: 2px;">SUPPORT MENU</div> <ul style="list-style-type: none"> Setup Advanced Tools Status mydlink Settings 				
<div style="background-color: #34495e; color: white; padding: 2px;">SETUP HELP</div> <ul style="list-style-type: none"> Internet Connection WAN Wireless Network Settings STORAGE IPv6 					
<div style="background-color: #34495e; color: white; padding: 2px;">ADVANCED HELP</div> <ul style="list-style-type: none"> Virtual Server Port Forwarding Application Rules QoS Engine Network Filter Access Control Website Filter Inbound Filter Firewall Settings Routing Advanced Wireless Wi-Fi Protected Setup Advanced Network GUEST ZONE IPv6 FIREWALL RULES IPv6 Routing 					
<div style="background-color: #34495e; color: white; padding: 2px;">TOOLS HELP</div> <ul style="list-style-type: none"> Admin Time Syslog Email Settings System Firmware Dynamic DNS System Check Schedules 					
<div style="background-color: #34495e; color: white; padding: 2px;">STATUS HELP</div> <ul style="list-style-type: none"> Device Info Logs Statistics Internet Sessions Wireless IPv6 IPv6 Routing 					
WIRELESS					

Connect a Wireless Client to your Router

WPS Button

The easiest and most secure way to connect your wireless devices to the router is WPS (Wi-Fi Protected Setup). Most wireless devices such as wireless adapters, media players, Blu-ray DVD players, wireless printers and cameras will have a WPS button (or a software utility with WPS) that you can press to connect to the DIR-865L router. Please refer to your user manual for the wireless device you want to connect to make sure you understand how to enable WPS. Once you know, follow the steps below:

Step 1 - Press the WPS button on the DIR-865L for about 1 second. The Internet LED on the front will start to blink.



Step 2 - Within 2 minutes, press the WPS button on your wireless client (or launch the software utility and start the WPS process).

Step 3 - Allow up to 1 minute to configure. Once the Internet light stops blinking, you will be connected and your wireless connection will be secure with WPA2.

Windows® 7

WPA/WPA2

It is recommended to enable wireless security (WPA/WPA2) on your wireless router or access point before configuring your wireless adapter. If you are joining an existing network, you will need to know the security key or passphrase being used.

1. Click on the wireless icon in your system tray (lower-right corner).

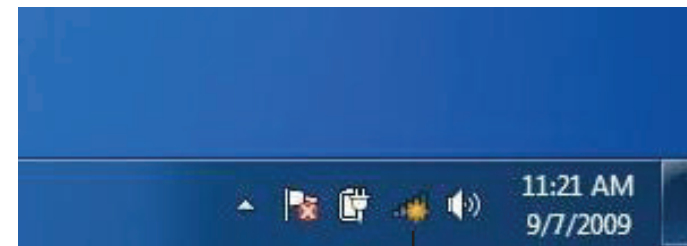

Wireless Icon

2. The utility will display any available wireless networks in your area.



3. Highlight the wireless connection with Wi-Fi name (SSID) you would like to connect to and click the **Connect** button.

If you get a good signal but cannot access the Internet, check your TCP/IP settings for your wireless adapter. Refer to the Networking Basics section in this manual for more information.



4. The following window appears while your computer tries to connect to the router.

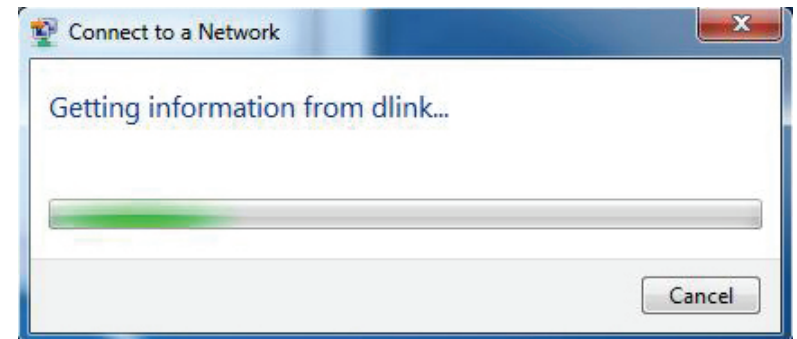

5. Enter the same security key or passphrase (Wi-Fi password) that is on your router and click **Connect**. You can also connect by pushing the WPS button on the router.

It may take 20-30 seconds to connect to the wireless network. If the connection fails, please verify that the security settings are correct. The key or passphrase must be exactly the same as on the wireless router.

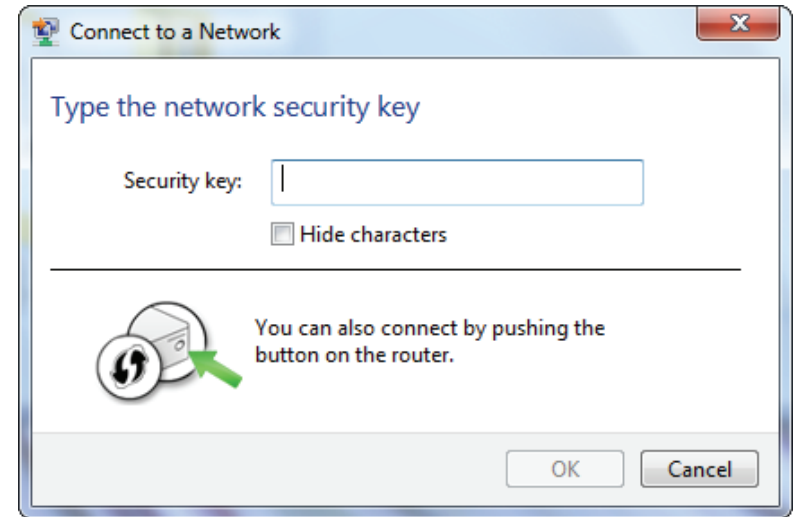

WPS

The WPS feature of the DIR-865L can be configured using Windows® 7. Carry out the following steps to use Windows® 7 to configure the WPS feature:

1. Click the **Start** button and select **Computer** from the Start menu.

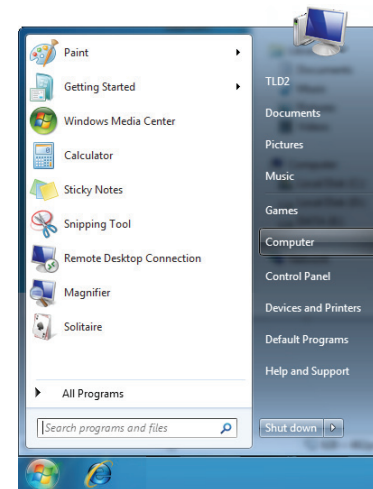

2. Click **Network** on the left side.

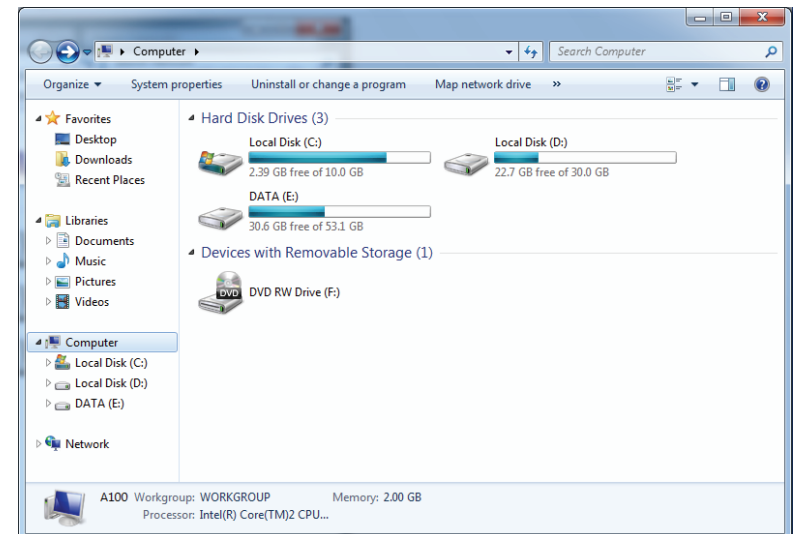

3. Double-click the DIR-865L.

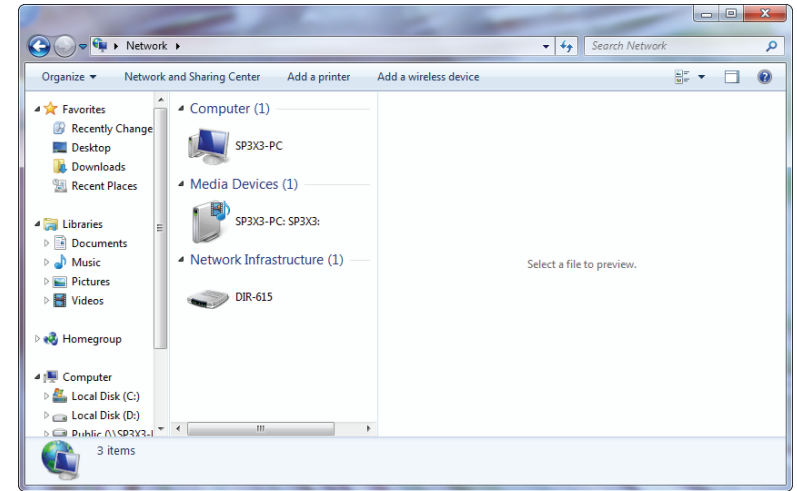

4. Input the WPS PIN number (displayed in the WPS window on the Router's LCD screen or in the **Setup > Wireless Setup** menu in the Router's Web UI) and click **Next**.

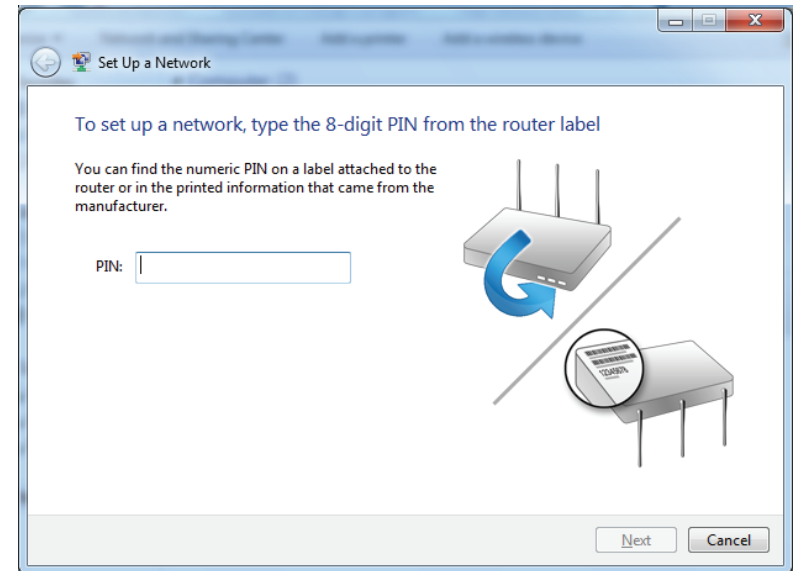

5. Type a name to identify the network.

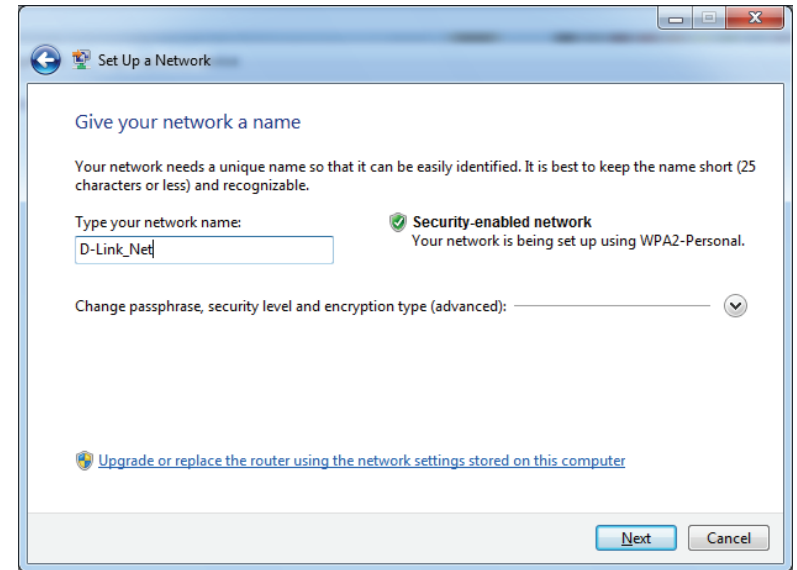

6. To configure advanced settings, click the  icon.

Click **Next** to continue.

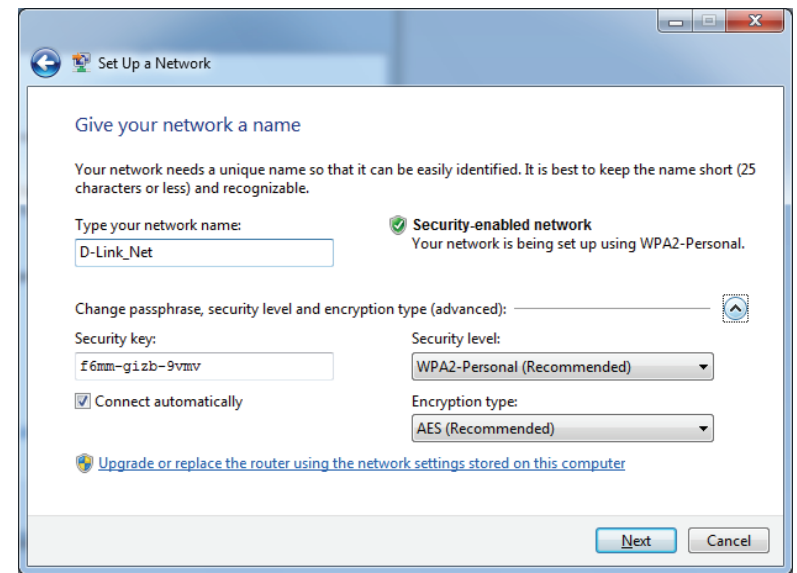

7. The following window appears while the Router is being configured.

Wait for the configuration to complete.

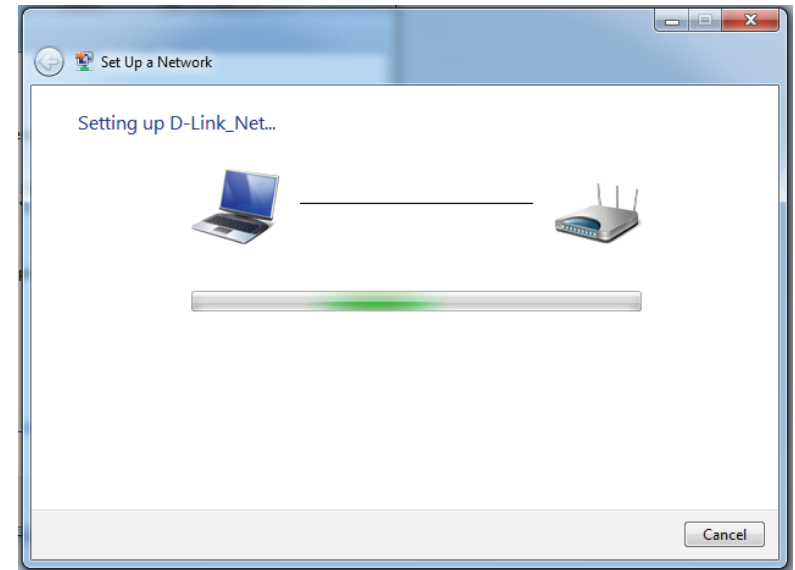

8. The following window informs you that WPS on the router has been setup successfully.

Make a note of the security key as you may need to provide this security key if adding an older wireless device to the network in the future.

9. Click **Close** to complete WPS setup.

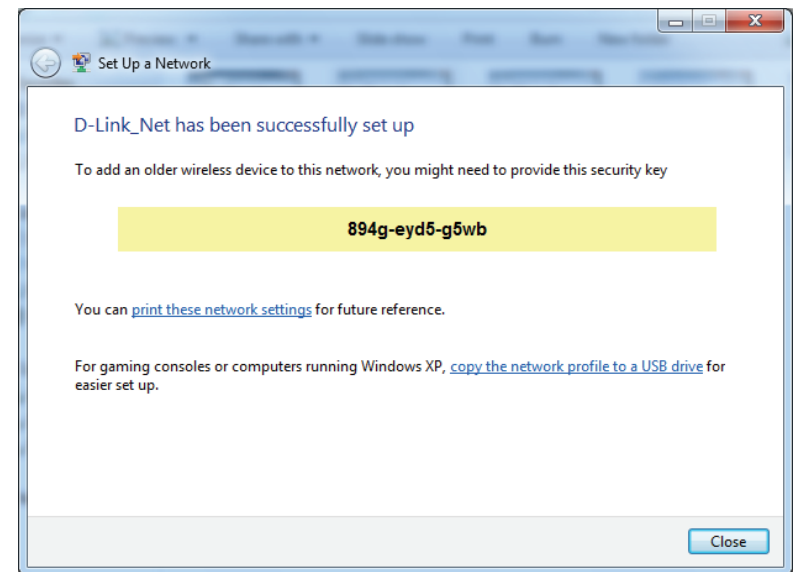

Windows Vista®

Windows Vista® users may use the built-in wireless utility. If you are using another company's utility, please refer to the user manual of your wireless adapter for help with connecting to a wireless network. Most utilities will have a "site survey" option similar to the Windows Vista® utility as seen below.

If you receive the **Wireless Networks Detected** bubble, click on the center of the bubble to access the utility.

or

Right-click on the wireless computer icon in your system tray (lower-right corner next to the time). Select **Connect to a network**.

The utility will display any available wireless networks in your area. Click on a network (displayed using the SSID) and click the **Connect** button.

If you get a good signal but cannot access the Internet, check you TCP/IP settings for your wireless adapter. Refer to the **Networking Basics** section in this manual for more information.

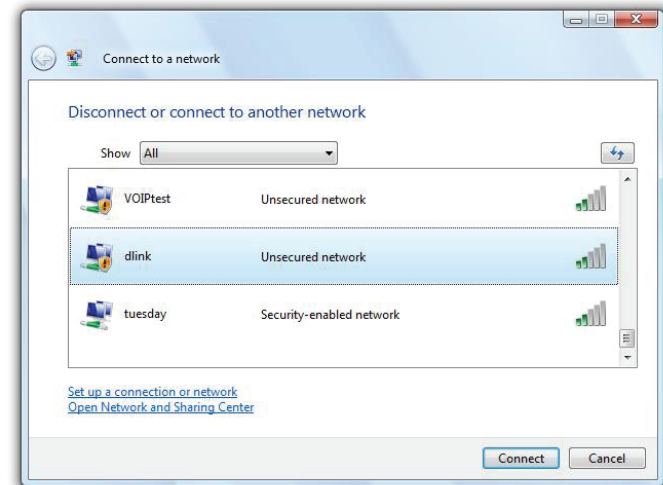
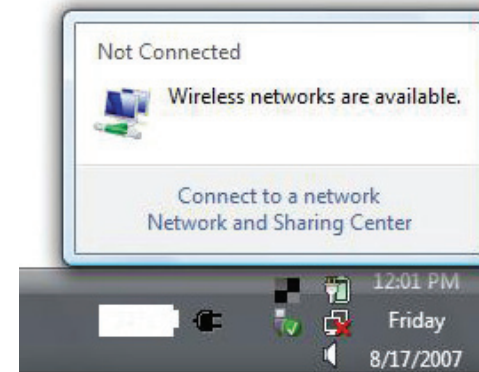

WPA/WPA2

It is recommended to enable wireless security (WPA/WPA2) on your wireless router or access point before configuring your wireless adapter. If you are joining an existing network, you will need to know the security key or passphrase being used.

1. Open the Windows Vista® Wireless Utility by right-clicking on the wireless computer icon in your system tray (lower right corner of screen). Select **Connect to a network**.
2. Highlight the Wi-Fi name (SSID) you would like to connect to and click **Connect**.

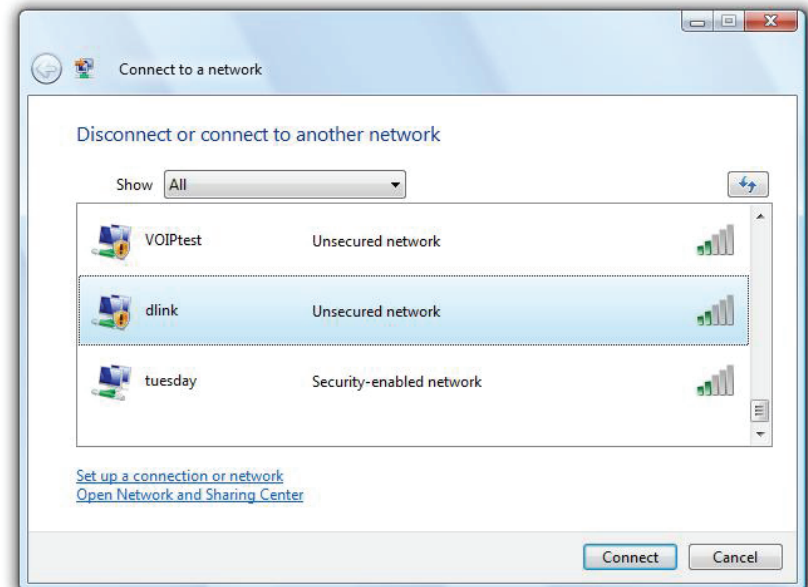
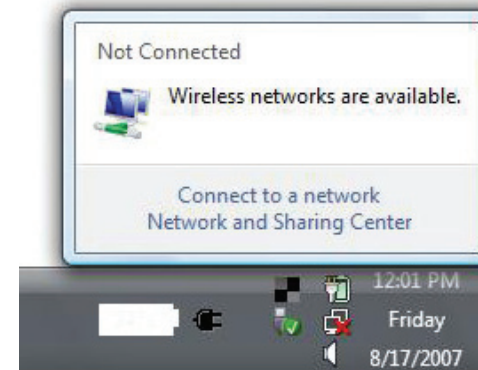

3. Enter the same security key or passphrase (Wi-Fi password) that is on your router and click **Connect**.

It may take 20-30 seconds to connect to the wireless network. If the connection fails, please verify that the security settings are correct. The key or passphrase must be exactly the same as on the wireless router.

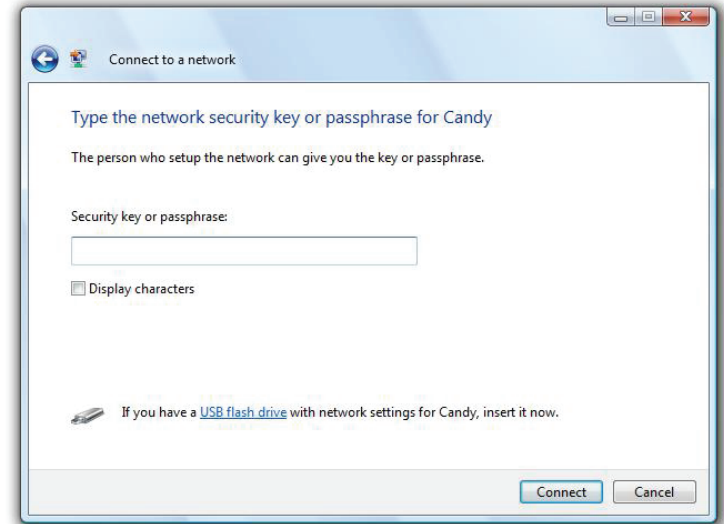

WPS/WCN 2.0

The router supports Wi-Fi protection, referred to as WCN 2.0 in Windows Vista®. The following instructions for setting this up depends on whether you are using Windows Vista® to configure the router or third party software.

When you first set up the router, Wi-Fi protection is disabled and unconfigured. To enjoy the benefits of Wi-Fi protection, the router must be both enabled and configured. There are three basic methods to accomplish this: use Windows Vista's built-in support for WCN 2.0, use software provided by a third party, or manually configure.

If you are running Windows Vista®, log into the router and click the **Enable** checkbox in the **Basic > Wireless** section. Use the Current PIN that is displayed on the **Advanced > Wi-Fi Protected Setup** section or choose to click the **Generate New PIN** button or **Reset PIN to Default** button.



If you are using third party software to set up Wi-Fi Protection, carefully follow the directions. When you are finished, proceed to the next section to set up the newly-configured router.

Windows® XP

Windows® XP users may use the built-in wireless utility (Zero Configuration Utility). The following instructions are for Service Pack 2 users. If you are using another company's utility, please refer to the user manual of your wireless adapter for help with connecting to a wireless network. Most utilities will have a "site survey" option similar to the Windows® XP utility as seen below.

If you receive the **Wireless Networks Detected** bubble, click on the center of the bubble to access the utility.

or

Right-click on the wireless computer icon in your system tray (lower-right corner next to the time). Select **View Available Wireless Networks**.

The utility will display any available wireless networks in your area. Click on a Wi-Fi network (displayed using the SSID) and click the **Connect** button.

If you get a good signal but cannot access the Internet, check you TCP/IP settings for your wireless adapter. Refer to the **Networking Basics** section in this manual for more information.

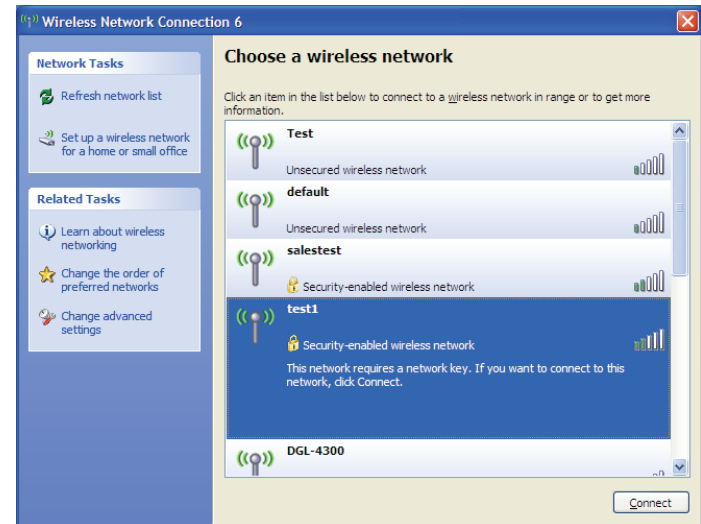
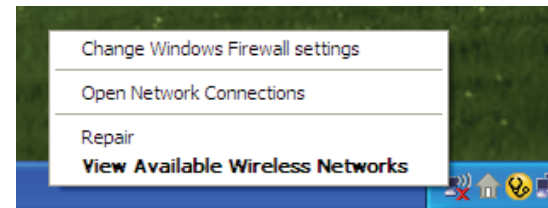
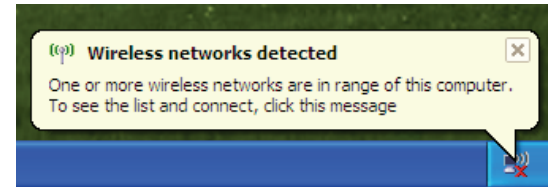

WPA/WPA2

It is recommended to enable WPA on your wireless router or access point before configuring your wireless adapter. If you are joining an existing network, you will need to know the WPA key being used.

1. Open the Windows® XP Wireless Utility by right-clicking on the wireless computer icon in your system tray (lower-right corner of screen). Select **View Available Wireless Networks**.
2. Highlight the Wi-Fi network (SSID) you would like to connect to and click **Connect**.

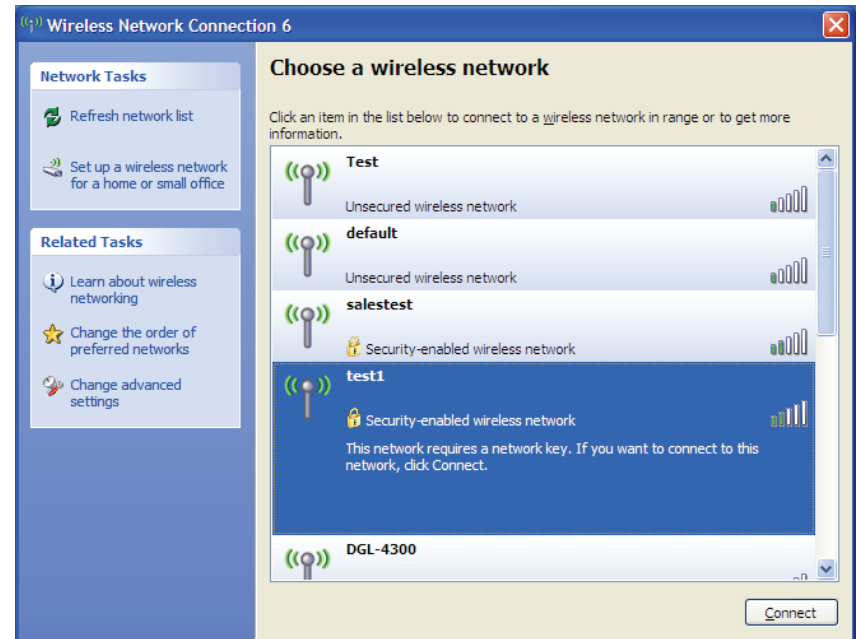
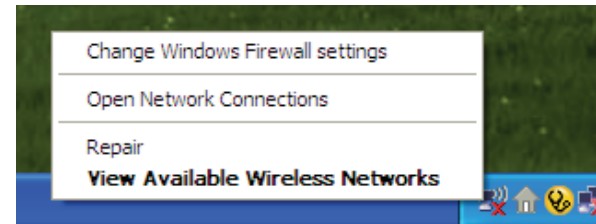

3. The **Wireless Network Connection** box will appear. Enter the WPA-PSK Wi-Fi password and click **Connect**.

It may take 20-30 seconds to connect to the wireless network. If the connection fails, please verify that the WPA-PSK settings are correct. The Wi-Fi password must be exactly the same as on the wireless router.

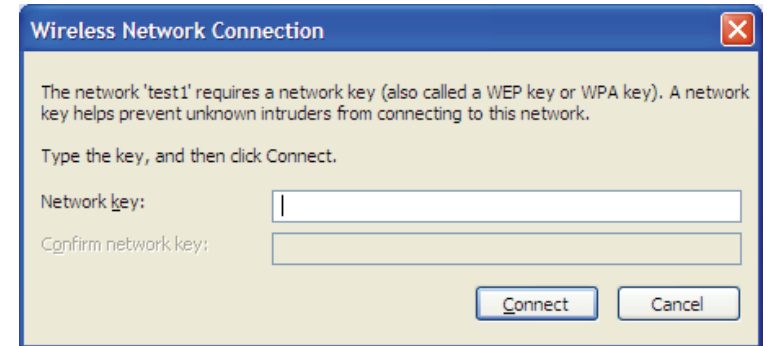

Troubleshooting

This chapter provides solutions to problems that can occur during the installation and operation of the DIR-865L. Read the following descriptions if you are having problems. The examples below are illustrated in Windows® XP. If you have a different operating system, the screenshots on your computer will look similar to the following examples.

1. Why can't I access the web-based configuration utility?

When entering the IP address of the D-Link router (192.168.0.1 for example), you are not connecting to a website nor do you have to be connected to the Internet. The device has the utility built-in to a ROM chip in the device itself. Your computer must be on the same IP subnet to connect to the web-based utility.

- Make sure you have an updated Java-enabled web browser. We recommend the following:
 - Microsoft Internet Explorer® 7 and higher
 - Mozilla Firefox 3.5 and higher
 - Google™ Chrome 8 and higher
 - Apple Safari 4 and higher
- Verify physical connectivity by checking for solid link lights on the device. If you do not get a solid link light, try using a different cable or connect to a different port on the device if possible. If the computer is turned off, the link light may not be on.
- Disable any Internet security software running on the computer. Software firewalls such as Zone Alarm, Black Ice, Sygate, Norton Personal Firewall, and Windows® XP firewall may block access to the configuration pages. Check the help files included with your firewall software for more information on disabling or configuring it.

- Configure your Internet settings:
 - Go to **Start > Settings > Control Panel**. Double-click the **Internet Options** icon. From the **Security** tab, click the button to restore the settings to their defaults.
 - Click the **Connection** tab and set the dial-up option to Never Dial a Connection. Click the LAN Settings button. Make sure nothing is checked. Click **OK**.
 - Go to the **Advanced** tab and click the button to restore these settings to their defaults. Click **OK** three times.
 - Close your web browser (if open) and open it.
- Access the web management. Open your web browser and enter the IP address of your D-Link router in the address bar. This should open the login page for your web management.
- If you still cannot access the configuration, unplug the power to the router for 10 seconds and plug back in. Wait about 30 seconds and try accessing the configuration. If you have multiple computers, try connecting using a different computer.

2. What can I do if I forgot my password?

If you forgot your password, you must reset your router. Unfortunately this process will change all your settings back to the factory defaults.

To reset the router, locate the reset button (hole) on the rear panel of the unit. With the router powered on, use a paperclip to hold the button down for 10 seconds. Release the button and the router will go through its reboot process. Wait about 30 seconds to access the router. The default IP address is 192.168.0.1. When logging in, the username is **admin** and leave the password box empty.

3. Why can't I connect to certain sites or send and receive emails when connecting through my router?

If you are having a problem sending or receiving email, or connecting to secure sites such as eBay, banking sites, and Hotmail, we suggest lowering the MTU in increments of ten (Ex. 1492, 1482, 1472, etc).

To find the proper MTU Size, you'll have to do a special ping of the destination you're trying to go to. A destination could be another computer, or a URL.

- Click on **Start** and then click **Run**.
- Windows® 95, 98, and Me users type in **command** (Windows® NT, 2000, XP, Vista®, and 7 users type in **cmd**) and press **Enter** (or click **OK**).
- Once the window opens, you'll need to do a special ping. Use the following syntax:

ping [url] [-f] [-l] [MTU value]

Example: **ping yahoo.com -f -l 1472**

```
C:\>ping yahoo.com -f -l 1482
Pinging yahoo.com [66.94.234.13] with 1482 bytes of data:
Packet needs to be fragmented but DF set.
Packet needs to be fragmented but DF set.
Packet needs to be fragmented but DF set.
Packet needs to be fragmented but DF set.
Ping statistics for 66.94.234.13:
    Packets: Sent = 4, Received = 0, Lost = 4 (100% loss),
    Approximate round trip times in milli-seconds:
        Minimum = 0ms, Maximum = 0ms, Average = 0ms
C:\>ping yahoo.com -f -l 1472
Pinging yahoo.com [66.94.234.13] with 1472 bytes of data:
Reply from 66.94.234.13: bytes=1472 time=93ms TTL=52
Reply from 66.94.234.13: bytes=1472 time=109ms TTL=52
Reply from 66.94.234.13: bytes=1472 time=125ms TTL=52
Reply from 66.94.234.13: bytes=1472 time=203ms TTL=52
Ping statistics for 66.94.234.13:
    Packets: Sent = 4, Received = 4, Lost = 0 (0% loss),
    Approximate round trip times in milli-seconds:
        Minimum = 93ms, Maximum = 203ms, Average = 132ms
C:\>
```

You should start at 1472 and work your way down by 10 each time. Once you get a reply, go up by 2 until you get a fragmented packet. Take that value and add 28 to the value to account for the various TCP/IP headers. For example, let's say that 1452 was the proper value, the actual MTU size would be 1480, which is the optimum for the network we're working with ($1452+28=1480$).

Once you find your MTU, you can now configure your router with the proper MTU size.

To change the MTU rate on your router follow the steps below:

- Open your browser, enter the IP address of your router (192.168.0.1) and click **OK**.
- Enter your username (admin) and password (blank by default). Click **OK** to enter the web configuration page for the device.
- Click on **Setup** and then click **Manual Configure**.
- To change the MTU enter the number in the MTU field and click **Save Settings** to save your settings.
- Test your email. If changing the MTU does not resolve the problem, continue changing the MTU in increments of ten.

Wireless Basics

D-Link wireless products are based on industry standards to provide easy-to-use and compatible high-speed wireless connectivity within your home, business or public access wireless networks. Strictly adhering to the IEEE standard, the D-Link wireless family of products will allow you to securely access the data you want, when and where you want it. You will be able to enjoy the freedom that wireless networking delivers.

A wireless local area network (WLAN) is a cellular computer network that transmits and receives data with radio signals instead of wires. Wireless LANs are used increasingly in both home and office environments, and public areas such as airports, coffee shops and universities. Innovative ways to utilize WLAN technology are helping people to work and communicate more efficiently. Increased mobility and the absence of cabling and other fixed infrastructure have proven to be beneficial for many users.

Wireless users can use the same applications they use on a wired network. Wireless adapter cards used on laptop and desktop systems support the same protocols as Ethernet adapter cards.

Under many circumstances, it may be desirable for mobile network devices to link to a conventional Ethernet LAN in order to use servers, printers or an Internet connection supplied through the wired LAN. A Wireless Router is a device used to provide this link.

What is Wireless?

Wireless or Wi-Fi technology is another way of connecting your computer to the network without using wires. Wi-Fi uses radio frequency to connect wirelessly, so you have the freedom to connect computers anywhere in your home or office network.

Why D-Link Wireless?

D-Link is the worldwide leader and award winning designer, developer, and manufacturer of networking products. D-Link delivers the performance you need at a price you can afford. D-Link has all the products you need to build your network.

How does wireless work?

Wireless works similar to how cordless phone work, through radio signals to transmit data from one point A to point B. But wireless technology has restrictions as to how you can access the network. You must be within the wireless network range area to be able to connect your computer. There are two different types of wireless networks Wireless Local Area Network (WLAN), and Wireless Personal Area Network (WPAN).

Wireless Local Area Network (WLAN)

In a wireless local area network, a device called an Access Point (AP) connects computers to the network. The access point has a small antenna attached to it, which allows it to transmit data back and forth over radio signals. With an indoor access point as seen in the picture, the signal can travel up to 300 feet. With an outdoor access point the signal can reach out up to 30 miles to serve places like manufacturing plants, industrial locations, college and high school campuses, airports, golf courses, and many other outdoor venues.

Wireless Personal Area Network (WPAN)

Bluetooth is the industry standard wireless technology used for WPAN. Bluetooth devices in WPAN operate in a range up to 30 feet away.

Compared to WLAN the speed and wireless operation range are both less than WLAN, but in return it doesn't use nearly as much power which makes it ideal for personal devices, such as mobile phones, PDAs, headphones, laptops, speakers, and other devices that operate on batteries.

Who uses wireless?

Wireless technology has become so popular in recent years that almost everyone is using it, whether it's for home, office, business, D-Link has a wireless solution for it.

Home

- Gives everyone at home broadband access
- Surf the web, check email, instant message, etc.
- Gets rid of the cables around the house
- Simple and easy to use

Small Office and Home Office

- Stay on top of everything at home as you would at office
- Remotely access your office network from home
- Share Internet connection and printer with multiple computers
- No need to dedicate office space

Where is wireless used?

Wireless technology is expanding everywhere not just at home or office. People like the freedom of mobility and it's becoming so popular that more and more public facilities now provide wireless access to attract people. The wireless connection in public places is usually called "hotspots".

Using a D-Link Cardbus Adapter with your laptop, you can access the hotspot to connect to Internet from remote locations like: Airports, Hotels, Coffee Shops, Libraries, Restaurants, and Convention Centers.

Wireless network is easy to setup, but if you're installing it for the first time it could be quite a task not knowing where to start. That's why we've put together a few setup steps and tips to help you through the process of setting up a wireless network.

Tips

Here are a few things to keep in mind, when you install a wireless network.

Centralize your router or Access Point

Make sure you place the router/access point in a centralized location within your network for the best performance. Try to place the router/access point as high as possible in the room, so the signal gets dispersed throughout your home. If you have a two-story home, you may need a repeater to boost the signal to extend the range.

Eliminate Interference

Place home appliances such as cordless telephones, microwaves, and televisions as far away as possible from the router/access point. This would significantly reduce any interference that the appliances might cause since they operate on same frequency.

Security

Don't let your next-door neighbors or intruders connect to your wireless network. Secure your wireless network by turning on the WPA or WEP security feature on the router. Refer to product manual for detail information on how to set it up.

Wireless Modes

There are basically two modes of networking:

- **Infrastructure** – All wireless clients will connect to an access point or wireless router.
- **Ad-Hoc** – Directly connecting to another computer, for peer-to-peer communication, using wireless network adapters on each computer, such as two or more DIR-865L wireless network Cardbus adapters.

An Infrastructure network contains an Access Point or wireless router. All the wireless devices, or clients, will connect to the wireless router or access point.

An Ad-Hoc network contains only clients, such as laptops with wireless cardbus adapters. All the adapters must be in Ad-Hoc mode to communicate.

Networking Basics

Check your IP address

After you install your new D-Link adapter, by default, the TCP/IP settings should be set to obtain an IP address from a DHCP server (i.e. wireless router) automatically. To verify your IP address, please follow the steps below.

Click on **Start > Run**. In the run box type **cmd** and click **OK**. (Windows® 7/Vista® users type **cmd** in the **Start Search** box.)

At the prompt, type **ipconfig** and press **Enter**.

This will display the IP address, subnet mask, and the default gateway of your adapter.

If the address is 0.0.0.0, check your adapter installation, security settings, and the settings on your router. Some firewall software programs may block a DHCP request on newly installed adapters.

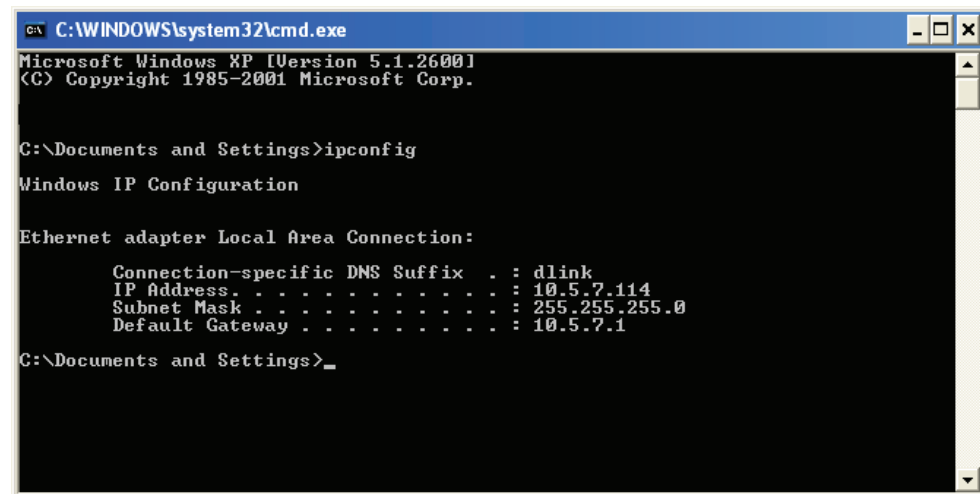

```
C:\WINDOWS\system32\cmd.exe
Microsoft Windows XP [Version 5.1.2600]
(C) Copyright 1985-2001 Microsoft Corp.

C:\Documents and Settings>ipconfig

Windows IP Configuration

Ethernet adapter Local Area Connection:

    Connection-specific DNS Suffix  . : dlink
    IP Address . . . . . : 10.5.7.114
    Subnet Mask . . . . . : 255.255.255.0
    Default Gateway . . . . . : 10.5.7.1

C:\Documents and Settings>_
```

Statically Assign an IP address

If you are not using a DHCP capable gateway/router, or you need to assign a static IP address, please follow the steps below:

- Step 1**
- Windows® 7 - Click on **Start > Control Panel > Network and Internet > Network and Sharing Center.**
 - Windows Vista® - Click on **Start > Control Panel > Network and Internet > Network and Sharing Center > Manage Network Connections.**
 - Windows® XP - Click on **Start > Control Panel > Network Connections.**
 - Windows® 2000 - From the desktop, right-click **My Network Places > Properties.**

Step 2
Right-click on the **Local Area Connection** which represents your network adapter and select **Properties.**

Step 3
Highlight **Internet Protocol (TCP/IP)** and click **Properties.**

Step 4
Click **Use the following IP address** and enter an IP address that is on the same subnet as your network or the LAN IP address on your router.

Example: If the router's LAN IP address is 192.168.0.1, make your IP address 192.168.0.X where X is a number between 2 and 99. Make sure that the number you choose is not in use on the network. Set the Default Gateway the same as the LAN IP address of your router (I.E. 192.168.0.1).

Set Primary DNS the same as the LAN IP address of your router (192.168.0.1). The Secondary DNS is not needed or you may enter a DNS server from your ISP.

Step 5
Click **OK** twice to save your settings.

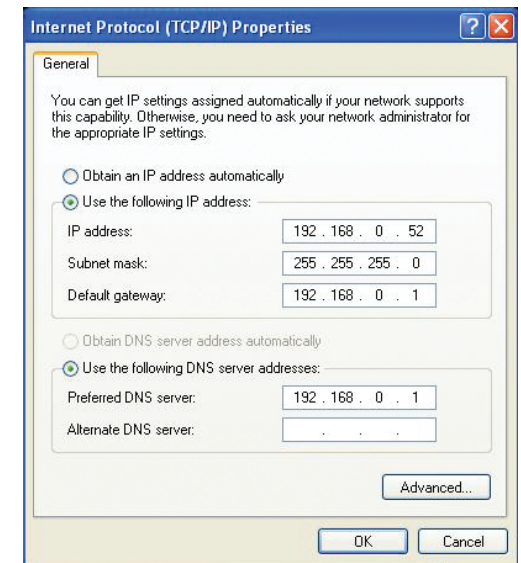

Technical Specifications

Hardware Specifications

- LAN Interface: Four 10/100/1000Mbps LAN ports
- WAN Interface: One 10/100/1000Mbps Internet port
- Wireless Interface (2.4GHz): IEEE 802.11b/g/n
- Wireless Interface (5GHz): IEEE 802.11a/n/ac
- USB Interface: Complaint USB 2.0

Operating Voltage

- Input: 100~240V ($\pm 20\%$), 50~60Hz
- Output: DC12V, 3A

Temperature

- Operating: 32 ~ 104°F (0 ~ 40°C)
- Non-Operating: -4 ~ 149°F (-20 ~ 65°C)

Humidity

- Operating: 10% - 90% non-condensing
- Non-Operating: 5% - 95% non-condensing

Wireless Frequency Range

- IEEE 802.11a: 5180 MHz~5240 MHz, 5745 MHz~5825 MHz
- IEEE 802.11b: 2400 MHz~2483 MHz
- IEEE 802.11g: 2400 MHz~2484 MHz
- IEEE 802.11n: 2400 MHz~2484 MHz, 5180 MHz~5240 MHz, 5745 MHz~5825 MHz
- IEEE 802.11ac: 5180 MHz~5240 MHz, 5745 MHz~5825 MHz

Wireless Bandwidth Rate

- IEEE 802.11a: 54, 48, 36, 24, 18, 12, 9, and 6 Mbps
- IEEE 802.11b: 11, 5.5, 2, and 1 Mbps
- IEEE 802.11g: 54, 48, 36, 24, 18, 12, 9, and 6 Mbps
- IEEE 802.11n: 6.5 to 300 Mbps
- IEEE 802.11ac: 6.5 to 1300 Mbps

Antenna Type

- Six Internal Antennas (Three 2.4 GHz Antennas, Three 5 GHz Antennas)

Wireless Security

- 64/128bit WEP, WPA/WPA2-Personal, WPA/WPA2-Enterprise, WPS (PIN & PBC)

Certifications

- FCC, CE, C-Tick.
- CSA internation
- Wi-Fi / WPS
- DLNA
- IPv6 Ready
- WIN 7

Dimensions & Weight

- 32 x 167 x 240 mm (1.26 x 6.57 x 9.45 in) (without pedestal)
- 70 x 167 x 252 mm (2.76 x 6.57 x 9.92 in) (with pedestal)
- 550 grams (1.22 lbs)

Warranty

- 1 years