



User Manual

All-in-One Mobile Companion

Preface

D-Link reserves the right to revise this publication and to make changes in the content hereof without obligation to notify any person or organization of such revisions or changes.

Manual Revisions

Revision	Date	Description
1.0	April 24, 2012	• Initial release
1.1	July 03, 2012	• Initial release
1.2	November 06, 2012	• Updated QRS Mobile app • Extended Wi-Fi network for Repeater Mode

Trademarks

D-Link and the D-Link logo are trademarks or registered trademarks of D-Link Corporation or its subsidiaries in the United States or other countries. All other company or product names mentioned herein are trademarks or registered trademarks of their respective companies.

Copyright © 2012 by D-Link Corporation.

All rights reserved. This publication may not be reproduced, in whole or in part, without prior expressed written permission from D-Link Corporation.

This purpose of this product is to create a constant network connection for your devices. As such, it does not have a standby mode or use a power management mode. If you wish to power down this product, please simply unplug it from the power outlet.

Table of Contents

Preface	i	Wireless Settings	38
Manual Revisions	i	Wireless Network Setup Wizard	39
Trademarks	i	Manual Wireless Network Configuration	41
Package Contents	1	Network Settings	45
System Requirements	2	Media Server	48
Introduction	3	Storage	49
Features	4	Advanced	51
Hardware Overview	5	Virtual Server	51
Front/Top	5	Application Rules	52
Bottom	6	MAC Address Filter	53
Operation Modes	7	Website Filters	54
Router Mode	8	Firewall Settings	55
Access Point Mode	9	Advanced Wireless	56
Repeater Mode	10	Wi-Fi Protected Setup (WPS)	57
Wi-Fi Hotspot Mode	11	UPnP Settings	58
Wireless Installation Considerations	12	Guest Zone	59
Setting Up Your DIR-505 Through the QRS Mobile App	13	DMZ	60
Setting Up Your DIR-505 Through WPS(Repeater)	15	Maintenance	61
Setting Up Your DIR-505 Through a Web Browser	16	Admin	61
Initial Setup Wizard (Router/AP Mode)	18	Time	62
Using the SharePort Mobile App (iOS, Android)	21	System	63
Router Mode	24	Firmware	64
Setup	25	Dynamic DNS	65
Internet Settings	25	System Check	66
Internet Connection Setup Wizard	26	Schedules	67
Manual Internet Setup	30	Status	68

Device Info	68	Help	95
Logs	69	Repeater Mode	96
Statistics	70	Setup Wizard	96
Internet Sessions.....	71	Setup Wizard	97
Wireless	72	Wireless Setup.....	100
Help	73	Extend Wi-Fi Setup	102
Access Point Mode	74	LAN Setup.....	103
Setup.....	75	Advanced	105
Setup Wizard	75	Advanced Wireless	105
Wireless Setup.....	76	Wi-Fi Protected Setup	106
LAN Setup.....	80	Maintenance	107
Advanced	81	Admin	107
MAC Address Filter	81	System	108
Advanced Wireless	82	Firmware	109
Wi-Fi Protected Setup (WPS)	83	Time.....	110
User Limit.....	84	Status	111
Maintenance	85	Device Info	111
Admin	85	Logs	112
System	86	Statistics	113
Firmware	87	Help	114
Time	88	Wi-Fi Hot Spot Mode	115
System Check.....	89	Setup	115
Schedules	90	Quick Setup Wizard.....	115
Status	91	Wi-Fi Hotspot Setup.....	117
Device Info	91	Wireless LAN Setup.....	119
Logs	92	LAN Setup.....	121
Statistics	93	Media Server.....	122
Wireless	94	Storage	123

Advanced	125	Networking Basics	158
MAC Address Filter	125	Statically Assign an IP address	159
Advanced Wireless	126	Technical Specifications	160
Maintenance	127	GPL Code Statement.....	161
Admin	127	Safety Statements	176
Time	128		
System	129		
Firmware	130		
Status	131		
Device Info	131		
Logs	132		
Statistics	133		
Help	134		
Connecting a Wireless Client	135		
WPS Button	135		
Windows® 7	136		
WPA/WPA2	136		
WPS	139		
Windows Vista®	143		
WPA/WPA2	144		
WPS/WCN 2.0	146		
Windows® XP	147		
WPA/WPA2	148		
Troubleshooting	150		
Wireless Basics	154		
What is Wireless?	155		
Tips	157		

Package Contents



DIR-505 All-in-One Mobile Companion



Quick Install Guide



Companion Card

If any of the above items are missing from your package, please contact your reseller.

System Requirements

<p>Network Requirements</p>	<ul style="list-style-type: none"> • An Ethernet-based Cable or DSL modem • IEEE 802.11n or 802.11g wireless clients • 10/100 Ethernet
<p>Web-based Configuration Utility Requirements</p>	<p>Computer with the following:</p> <ul style="list-style-type: none"> • Windows®, Macintosh, or Linux-based operating system • An installed Ethernet adapter <p>Browser Requirements:</p> <ul style="list-style-type: none"> • Internet Explorer 8 or higher • Firefox 8.0 or higher • Safari 4.0 or higher • Google Chrome (16.0.9.12.75) <p>Windows® Users: Make sure you have the latest version of Java installed. Visit www.java.com to download the latest version.</p>
<p>CD Installation Wizard Requirements</p>	<p>Computer with the following:</p> <ul style="list-style-type: none"> • Windows® 7, Vista®, or XP (Service Pack 2 or higher), Mac OS X (v10.7) • An installed Ethernet adapter • CD-ROM drive

Introduction

TOTAL PERFORMANCE

Combines award winning router features and Wireless N 150 technology to provide the best wireless performance.

TOTAL SECURITY

The most complete set of security features including Active Firewall and WPA/WPA2 to protect your network against outside intruders.

TOTAL COVERAGE

Provides greater wireless signal rates even at farther distances for best-in-class Whole Home Coverage.

ULTIMATE PERFORMANCE

The D-Link All-in-One Mobile Companion (DIR-505) lets you create a secure wireless network to share photos, files, music, video, printers, and network storage throughout your home. Connect the DIR-505 router to a cable or DSL modem and share your high-speed Internet access with everyone on the network. In addition, this Router includes a Quality of Service (QoS) engine that keeps digital phone calls (VoIP) and online gaming smooth and responsive, providing a better Internet experience.

TOTAL NETWORK SECURITY

The DIR-505 router supports all of the latest wireless security features to prevent unauthorized access, be it from over the wireless network or from the Internet. Support for WPA/WPA2 standards ensure that you'll be able to use the best possible encryption method, regardless of your client devices. In addition, this router utilizes dual active firewalls (SPI and NAT) to prevent potential attacks from across the Internet.

* Maximum wireless signal rate derived from IEEE Standard 802.11n and 802.11g specifications. Actual data throughput will vary. Network conditions and environmental factors, including volume of network traffic, building materials and construction, and network overhead, lower actual data throughput rate. Environmental conditions will adversely affect wireless signal range.

Features

- **Faster Wireless Networking** - The DIR-505 provides an up to 150 Mbps* wireless connection with other 802.11n wireless clients. This capability allows users to participate in real-time activities online, such as video streaming, online gaming, and real-time audio.
- **Compatible with 802.11g/b Devices** - The DIR-505 is still fully compatible with the IEEE 802.11g/b standards, so it can connect with existing 802.11g/b devices.
- **Advanced Firewall Features** - The Web-based user interface displays a number of advanced network management features including:
 - **Content Filtering** - Easily applied content filtering based on MAC address and website address.
 - **Filter Scheduling** - These filters can be scheduled to be active on certain days or for a duration of hours or minutes.
 - **Secure Multiple/Concurrent Sessions** - The DIR-505 can pass through VPN sessions. It supports multiple and concurrent IPSec and PPTP sessions, so users behind the DIR-505 can securely access corporate networks.
- **User-friendly Setup Wizard** - Through its easy-to-use Web-based user interface, the DIR-505 lets you control what information is accessible to those on the wireless network, whether from the Internet or from your company's server. Configure your router to your specific settings within minutes.

* Maximum wireless signal rate derived from IEEE Standard 802.11n and 802.11g specifications. Actual data throughput will vary. Network conditions and environmental factors, including volume of network traffic, building materials and construction, and network overhead, lower actual data throughput rate. Environmental conditions will adversely affect wireless signal range.

Hardware Overview

Front/Top

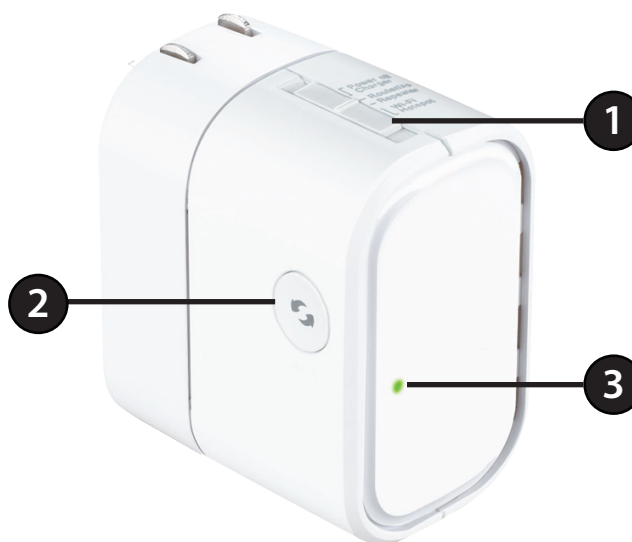

1	Mode Selector Switch	Slide this switch to select between Router/AP, Repeater, and Wi-Fi Hotspot modes.
2	WPS Button	Press this to activate Wi-Fi Protected Setup(WPS) to connect other devices wirelessly automatically.
3	LED Indicator	This indicates the current status of the DIR-505, as detailed in the table below.

LED Indicator	Color	Status	Description
Power/Status	Green	Solid Green	The device is powered ON and operating properly
		Blinking Green	The device is connecting to a device through WPS
		Light off	The device is off
	Red	Solid Red	During Power ON or system is defective
		Light off	The device is powered off

Hardware Overview

Bottom

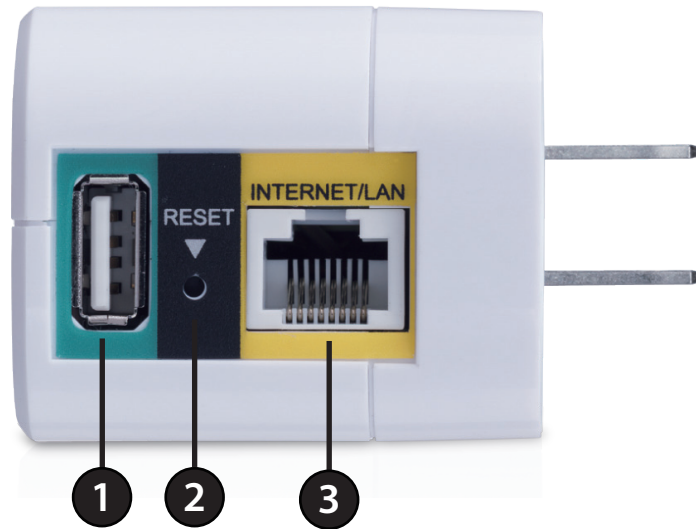

1	USB Port	Connect a USB storage drive to share files with connected clients through SharePort™ Mobile and SharePort™ Web File Access.
2	Reset Button	Pressing the Reset button restores the router to its original factory default settings.
3	Ethernet Port	The auto MDI/MDIX Internet port is the connection for the Ethernet cable to the cable or DSL modem.

Operation Modes

Depending on how you want to use your DIR-505 will determine which mode you use. The following pages describe each mode to help you figure out which one to use.

- Router Mode
- Access Point Mode
- Repeater Mode
- Wi-Fi Hotspot Mode

Router Mode

In Router Mode, the DIR-505 connects to your cable modem, DSL modem, or other Internet source and shares your Internet connection with your devices wirelessly, providing Internet access for an entire home or office. You can also share files with other computers or devices on your wireless network by using the SharePort Mobile feature.

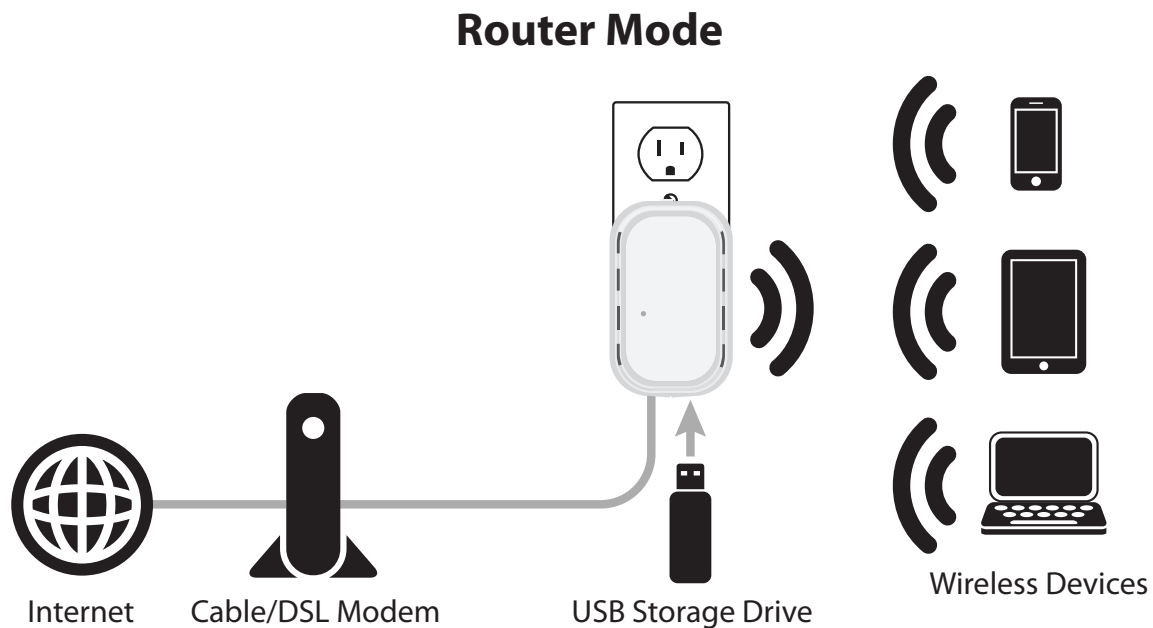

Access Point Mode

In Access Point Mode, the DIR-505 connects your wireless devices together, but does not provide routing functionality. It also allows a connected wired device to connect to your other devices wirelessly. This can be useful if you already have an existing Internet router that does not have built-in wireless capabilities. You can also use this to create a private wireless network without Internet access so that your devices can securely connect to one another without being exposed to the Internet or other computers.

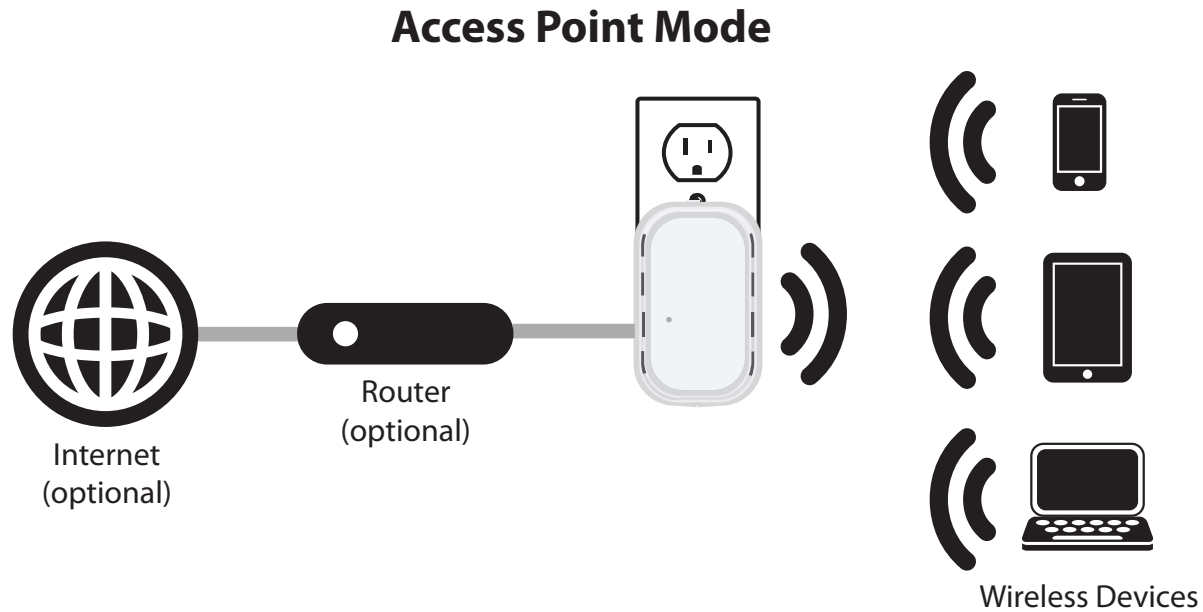

Repeater Mode

In Repeater Mode, the DIR-505 extends the range of an existing wireless network. You can use this to extend the coverage of an existing wireless router to provide better signal for parts of your home or office that may have poor reception. Additionally, you can use this mode to connect a wired device to a wireless network, which can be useful for devices that do not have a built-in wireless card, such as some smart TVs, game consoles, or DVRs.

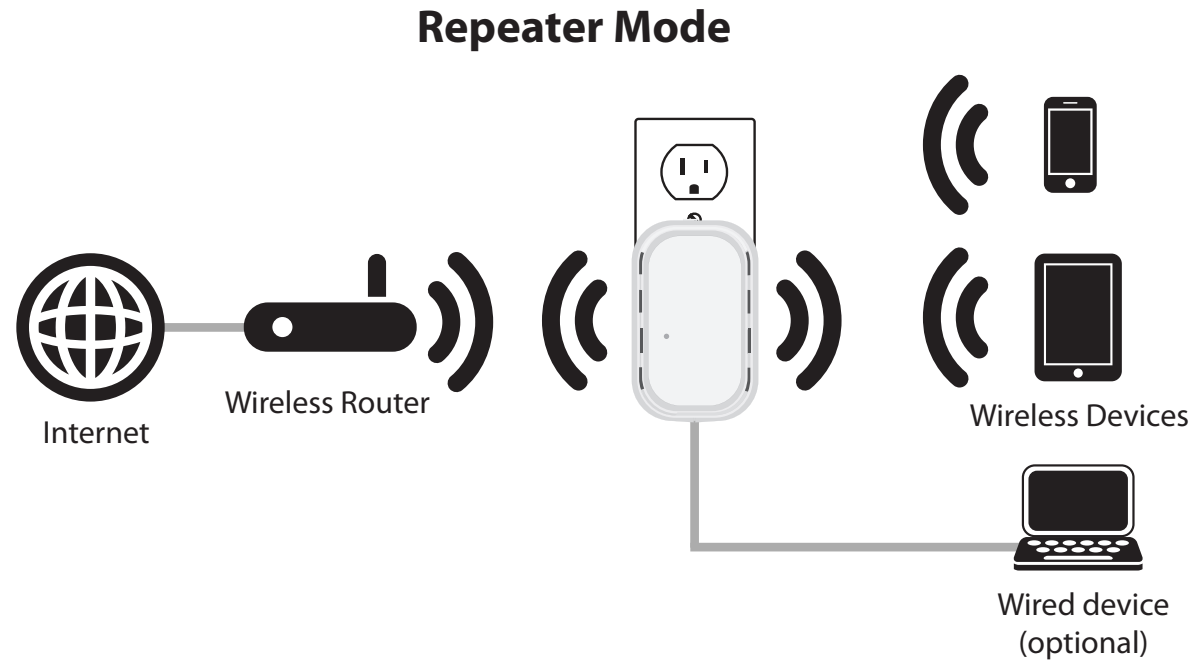

Wi-Fi Hotspot Mode

In Wi-Fi Hotspot Mode, the DIR-505 connects to a wireless hotspot or existing wireless network and lets you share access to that network with your devices. This mode is similar to Router mode, but instead of connecting to a cable or DSL modem as your Internet source, the DIR-505 connects to a Wi-Fi hotspot and shares that connection with your devices. This can be useful in places such as a hotel, airport, or café to use a single connection to a hotspot to provide an Internet connection for all your devices. Additionally, it can provide an added layer of security when connecting to public hotspots by hiding your computers and devices from other devices on the network, and keeping them in your own private network. You can also share files with other computers or devices on your wireless network by using the SharePort Mobile feature.

Wi-Fi Hot Spot Mode

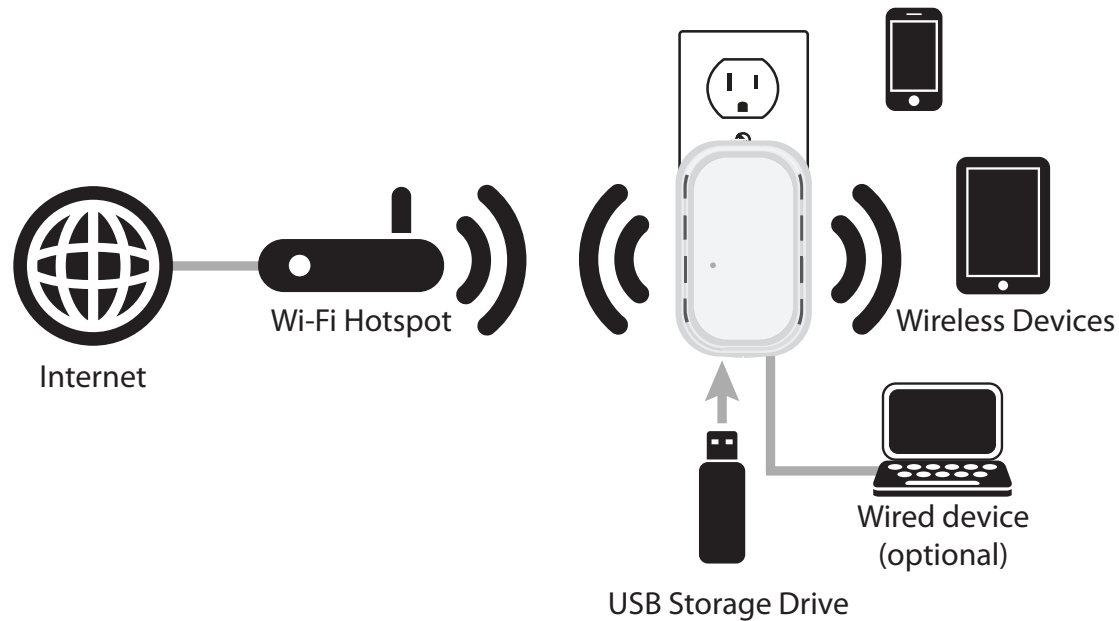

Wireless Installation Considerations

The D-Link wireless router lets you access your network using a wireless connection from virtually anywhere within the operating range of your wireless network. Keep in mind, however, that the number, thickness and location of walls, ceilings, or other objects that the wireless signals must pass through, may limit the range. Typical ranges vary depending on the types of materials and background RF (radio frequency) noise in your home or business. The key to maximizing wireless range is to follow these basic guidelines:

1. Keep the number of walls and ceilings between the D-Link router and other network devices to a minimum - each wall or ceiling can reduce your adapter's range from 3-90 feet (1-30 meters.) Position your devices so that the number of walls or ceilings is minimized.
2. Be aware of the direct line between network devices. A wall that is 1.5 feet thick (.5 meters), at a 45-degree angle appears to be almost 3 feet (1 meter) thick. At a 2-degree angle it looks over 42 feet (14 meters) thick! Position devices so that the signal will travel straight through a wall or ceiling (instead of at an angle) for better reception.
3. Building Materials make a difference. A solid metal door or aluminum studs may have a negative effect on range. Try to position access points, wireless routers, and computers so that the signal passes through drywall or open doorways. Materials and objects such as glass, steel, metal, walls with insulation, water (fish tanks), mirrors, file cabinets, brick, and concrete will degrade your wireless signal.
4. Keep your product away (at least 3-6 feet or 1-2 meters) from electrical devices or appliances that generate RF noise.
5. If you are using 2.4GHz cordless phones or X-10 (wireless products such as ceiling fans, lights, and home security systems), your wireless connection may degrade dramatically or drop completely. Make sure your 2.4GHz phone base is as far away from your wireless devices as possible. The base transmits a signal even if the phone is not in use.

Setting Up Your DIR-505 Through the QRS Mobile App

If you have an iOS or Android mobile device, you can use the QRS Mobile App to set up your DIR-505 without requiring a PC.

1. Use your mobile device to scan the appropriate QR code for your device to download the free **QRS Mobile** app from the App Store or Google Play.



If you do not have a QR code reader, you can simply search for **QRS Mobile** in the App Store or Google Play.

2. Move the switch on the top of the DIR-505 to the mode you wish to use, then plug it in. Verify that the power LED has turned green before continuing.

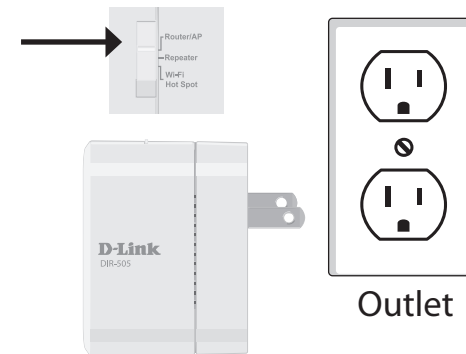

3. On your mobile device, go to your Wi-Fi settings and connect to the network that is displayed on the Wi-Fi Configuration Card included in your package (ex: **dlink-a8fa**). Then, enter the Wi-Fi password also printed on the Wi-Fi Configuration Card (**akbdj1936**).

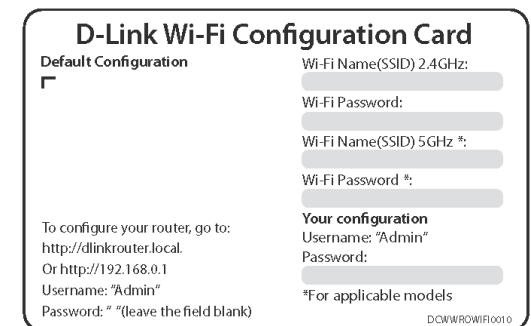

4. Once your mobile device is connected, tap on the **QRS Mobile** app.



5. Click **Start** to continue, and follow the on-screen instructions to configure your DIR-505.

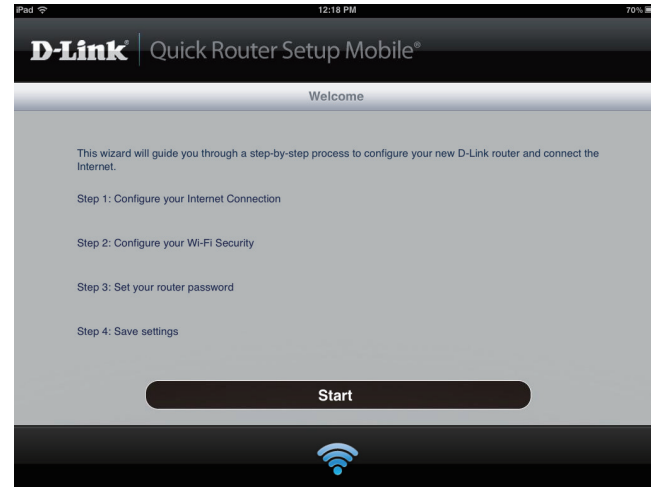

6. After setup is complete, the following screen will appear. You can now change your mobile device and laptop Wi-Fi settings to use the wireless network name and password you just created.

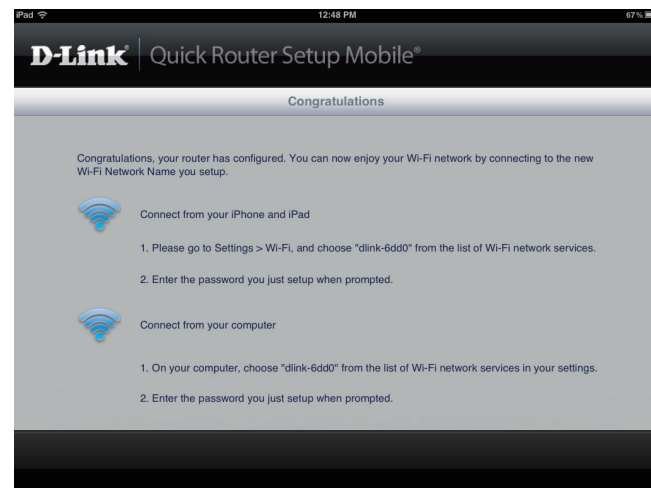

Setting Up Your DIR-505 Through WPS(Repeater)

If you are setting the DIR-505 up in Repeater Mode to extend the range of an existing Wi-Fi network and your existing wireless router has a WPS button, you can use these steps to quickly set up your DIR-505.

1. Move the switch on the top of the DIR-505 to Repeater Mode, then plug it in within range of your existing Wi-Fi network. Verify that the power LED has turned green before continuing.

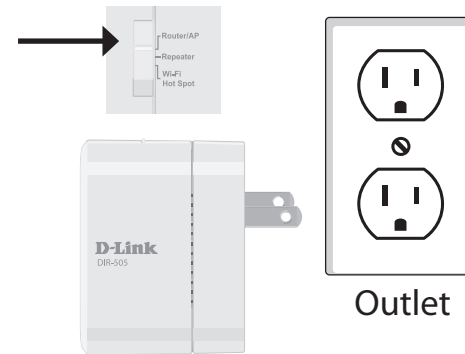

2. Press and hold the WPS button on the side of the DIR-505 for 5 seconds.

Note: You must press the WPS button for at least 5 seconds. Pressing it for a shorter time activates a different WPS mode which is used to connect wireless devices to the DIR-505.

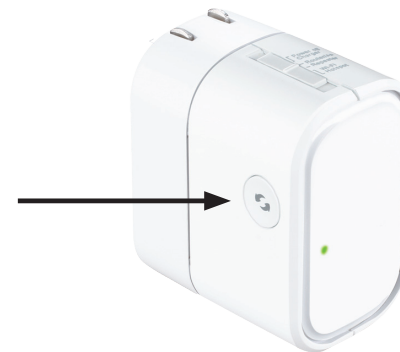

3. Within 2 minutes, press the WPS button on your existing wireless router. The DIR-505 will automatically create a connection to your existing router's Wi-Fi network and will extend it. You can connect to your extended network by using the default Wi-Fi network name and password printed on the Wi-Fi Configuration Card. To set the DIR-505 to use the same Wi-Fi network name and number, refer to "Extend Wi-Fi Setup" on page 102.

Setting Up Your DIR-505 Through a Web Browser

1. Move the switch on the top of the DIR-505 to the mode you wish to use, then plug it in. Verify that the power LED has turned green before continuing.

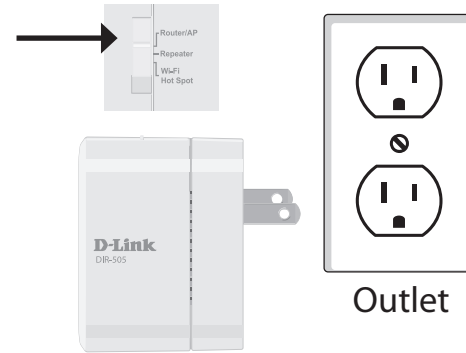

If you are using Router/AP Mode:

Move the switch on the top of the DIR-505 to **Router/AP** and plug it into a wall outlet near your cable/DSL modem or router.

Connect one end of the Ethernet cable into the Ethernet port of your cable/DSL modem or router and then plug the other end of the cable into the Ethernet port of the DIR-505. Verify that the power LED has turned green before continuing.

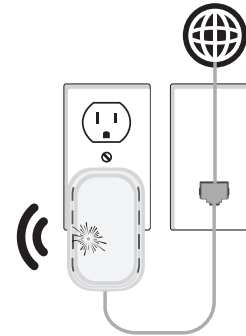

2. From your laptop or mobile device, go to your Wireless Utility to display the available wireless networks and select the Wi-Fi name that is printed on the Wi-Fi Configuration Card included in your package (ex: **dlink-a8fa**). Then, enter the Wi-Fi password also printed on the Wi-Fi Configuration Card (**akbdj1936**).

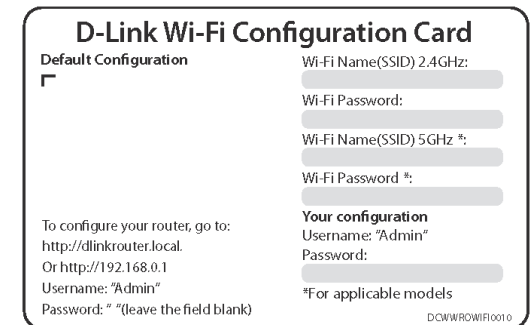

3. Open a web browser. Firsttime users will automatically be directed to the appropriate Setup Wizard for the selected operation mode. For more details about this wizard, refer to “Initial Setup Wizard (Router/AP Mode)” on page 18.

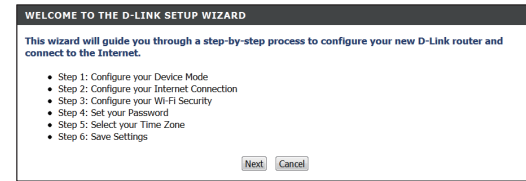

If the Setup Wizard does not appear, type **http://dlinkrouter** in the address bar.

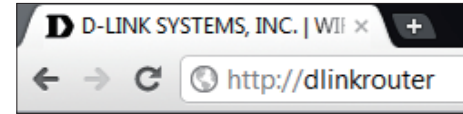

If you have set up the DIR-505 before, you will see a login screen. Select Admin as your user name, and enter the password for the DIR-505. By default, the password is blank. The configuration interface will open, and you can configure the different settings of the DIR-505.

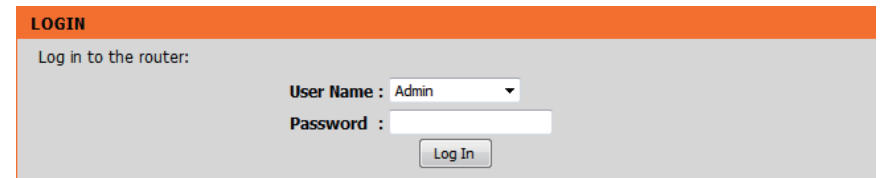

For detailed information on configuring your device, refer to the following sections of the manual:

- “Router Mode” on page 24
- “Access Point Mode” on page 74
- “Repeater Mode” on page 96
- “Wi-Fi Hot Spot Mode” on page 115

Initial Setup Wizard (Router/AP Mode)

If this is your first time setting up the DIR-505, open your web browser. You will automatically be directed to the **Wizard Setup Screen**.

If the Setup Wizard does not appear automatically, type **http://dlinkrouter.local** in the address bar.

If you have already configured your settings and you would like to access the configuration utility, please refer to “Setting Up Your DIR-505 Through a Web Browser” on page 16.

This wizard is designed to guide you through a step-by-step process to configure your new D-Link router and connect to the Internet.

Click **Next** to continue.

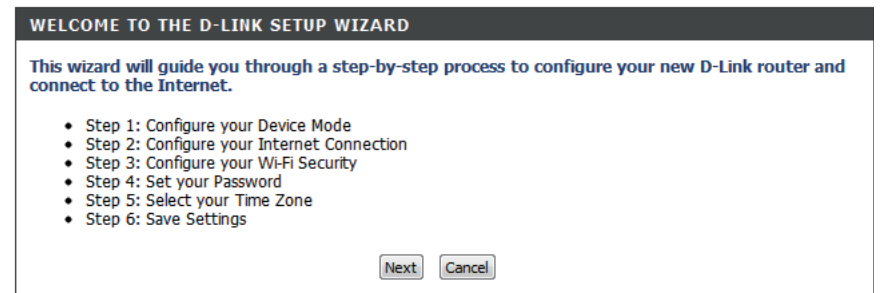
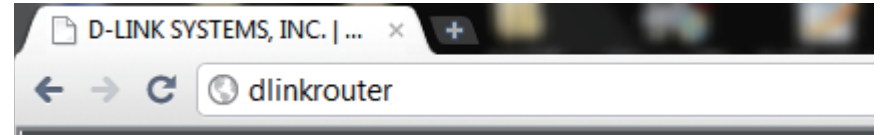

Select whether you want to use **Router** mode or **Access Point** mode for your DIR-505 and click **Next**. In most situations, Router mode should be used.

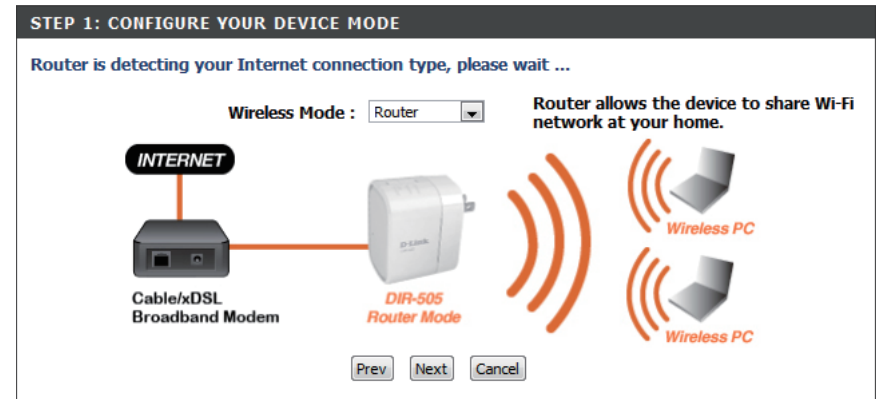

If you chose Router mode, the DIR-505 will try to detect what type of Internet connection you have and will ask you for the related settings. Enter the settings for your connection and click **Next**.

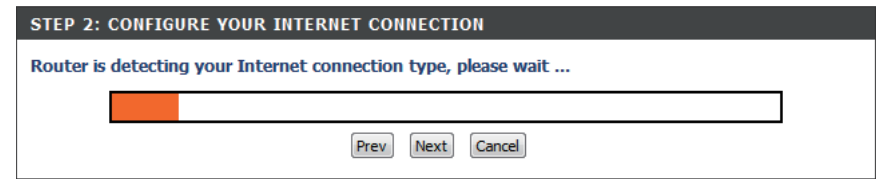

If your Internet connection cannot be detected (or if you click the **Prev** button after the previous step), you will need to select which type of Internet connection you have. Select your Internet connection type, then click the **Next** button and enter the related settings.

Note: Most cable modem connections use DHCP, and most DSL modem connections use **PPPoE**. If you are not sure which connection type you use or what settings to enter, contact your Internet service provider.

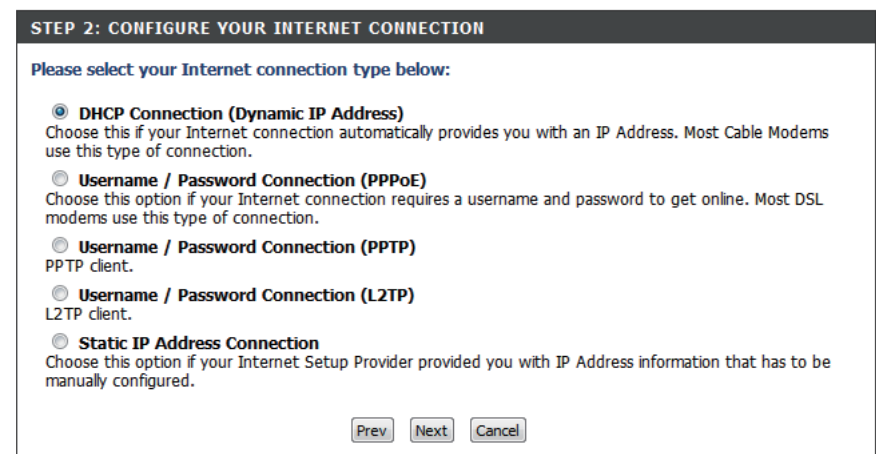

Create a wireless security passphrase or key (between 8-63 characters). Your wireless clients will need to have this passphrase or key entered to be able to connect to your wireless network.

Click **Next** to continue.

Enter a password to secure configuration access to your router. Please note that this password will be used to log in to the configuration interface, but is not the same as the password used for your wireless network. Check the **Enable Graphical Authentication** box to enable CAPTCHA authentication for added security. Click **Next** to continue.

Select your time zone from the drop-down menu and click **Next** to continue.

Setup is complete, and your wireless network name and password will be displayed. It is recommended that you write this information down for future reference. Click **Save** to save your settings and reboot the router.

STEP 3: CONFIGURE YOUR WI-FI SECURITY

Give your Wi-Fi network a name.

Wi-Fi Network Name (SSID) :
 (Using up to 32 characters)

Give your Wi-Fi network a password.

Wi-Fi Password :
 (Between 8 and 63 characters)

STEP 4: SET YOUR PASSWORD

By default, your new D-Link Router does not have a password configured for administrator access to the Web-based configuration pages. To secure your new networking device, please set and verify a password below, and enabling CAPTCHA Graphical Authentication provides added security protection to prevent unauthorized online users and hacker software from accessing your network settings.

Password :

Verify Password :

Enable Graphical Authentication :

STEP 5: SELECT YOUR TIME ZONE

Select the appropriate time zone for your location. This information is required to configure the time-based options for the router.

SETUP COMPLETE!

Below is a detailed summary of your Wi-Fi security settings. Please print this page out, or write the information on a piece of paper, so you can configure the correct settings on your Wi-Fi devices.

Wi-Fi Network Name (SSID): MyDLinkNetwork
Wi-Fi Password : MyPassword

The Setup Wizard has completed. Click the Save button to save your settings and restart the router.

Using the SharePort Mobile App (iOS, Android)

The SharePort Mobile app allows you to remotely access files stored on a USB flash drive or USB external hard drive connected to the DIR-505. For more information on using this feature, please refer to "Storage" on page 49.

Note: The SharePort Web/SharePort Mobile feature of the DIR-505 can only be used when the device is in **Router** or **Wi-Fi Hot Spot** mode; it will not work in **Repeater** mode.

1. Make sure that the switch on top of the DIR-505 is set to **Router/AP** or **Wi-Fi Hotspot**.

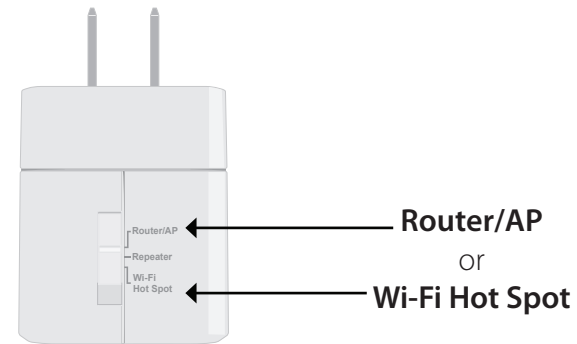

2. Plug your USB storage drive into the USB port on the bottom of the DIR-505, and then plug the DIR-505 into a power outlet.

Note: The DIR-505 works with USB storage drives up to 250 GB.

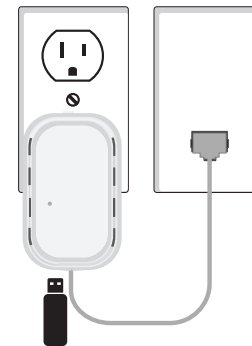

3. Use your iOS or Android mobile device to scan the appropriate QR code for your device to download the free **SharePort Mobile** app from the App Store or Google Play.

If you do not have a QR code reader, you can simply search for **SharePort Mobile** in the App Store or Google Play.



4. On your mobile device, go to your Wi-Fi settings and connect to the Wi-Fi network that you created during initial setup. The default Wi-Fi network name and password are printed on the Wi-Fi Configuration Card included in your package.

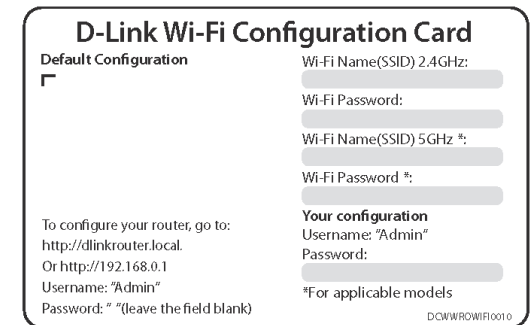
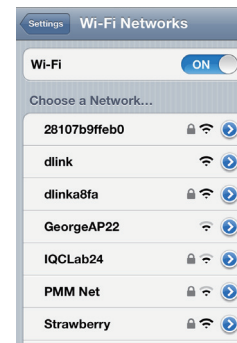

5. Once connected, tap the **SharePort** icon, and the SharePort app will load.



6. Tap on the **Settings** gear icon located on the right top corner of the screen. Then, click **Edit** to enter your User Name and Password. If you have not created a user account, you can use **admin** as your user name and your DIR-505 password(blank by default). Once you finish, click **Done** to continue.

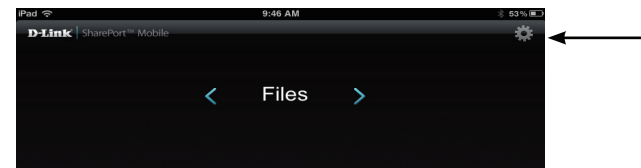

7. You can now use the SharePort Mobile app to access the files on your USB storage drive.

Note: If you connect a USB storage drive with many files or with a large capacity, it may take a while for the DIR-505 to scan and catalog your files.

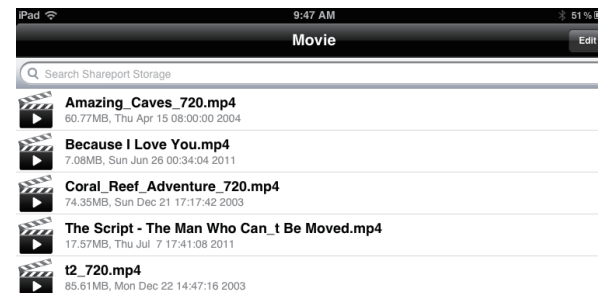

Router Mode

This section describes the configuration interface for Router mode. Make sure that the mode selector switch is in the Router/AP position on your DIR-505.

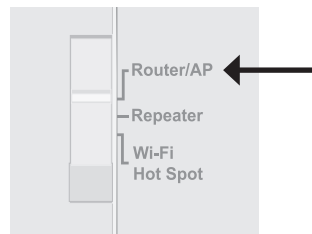

If this is your first time configuring the DIR-505, open your web browser and type **http://dlinkrouter** in the address bar. You will automatically be directed to the **Wizard Setup Screen**. For more information, refer to “Initial Setup Wizard (Router/AP Mode)” on page 18.

If the Setup Wizard does not appear, type **http://dlinkrouter** in the address bar.

Otherwise, the main configuration screen will appear. You will still be able to use the different setup wizards to configure your DIR-505.

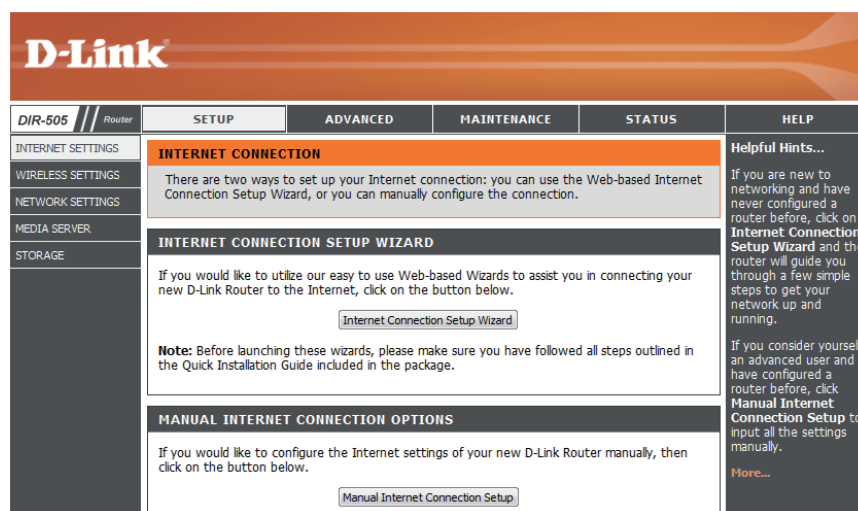

Setup

Internet Settings

If you want to configure your router to connect to the Internet using a setup wizard, click **Internet Connection Setup Wizard**, and continue to the next page.

To configure your Internet settings manually, click the **Manual Internet Connection Setup** button and go to “Manual Internet Setup” on page 30.

The screenshot shows the D-Link DIR-505 Router web interface. The top navigation bar includes the D-Link logo and tabs for SETUP, ADVANCED, MAINTENANCE, STATUS, and HELP. The left sidebar lists menu items: INTERNET SETTINGS, WIRELESS SETTINGS, NETWORK SETTINGS, MEDIA SERVER, and STORAGE. The main content area is titled "INTERNET CONNECTION" and contains the following sections:

- INTERNET CONNECTION**: A header section with a sub-header "INTERNET CONNECTION" and a paragraph: "There are two ways to set up your Internet connection: you can use the Web-based Internet Connection Setup Wizard, or you can manually configure the connection."
- INTERNET CONNECTION SETUP WIZARD**: A section with a sub-header "INTERNET CONNECTION SETUP WIZARD" and a paragraph: "If you would like to utilize our easy to use Web-based Wizards to assist you in connecting your new D-Link Router to the Internet, click on the button below." Below this is a button labeled "Internet Connection Setup Wizard". A note follows: "Note: Before launching these wizards, please make sure you have followed all steps outlined in the Quick Installation Guide included in the package."
- MANUAL INTERNET CONNECTION OPTIONS**: A section with a sub-header "MANUAL INTERNET CONNECTION OPTIONS" and a paragraph: "If you would like to configure the Internet settings of your new D-Link Router manually, then click on the button below." Below this is a button labeled "Manual Internet Connection Setup".

On the right side of the interface, there is a "Helpful Hints..." section with two paragraphs of text and a "More..." link.

At the bottom of the page, there is a "WIRELESS" section header and a copyright notice: "Copyright © 2012 D-Link Corporation/D-Link Systems, Inc."

Internet Connection Setup Wizard

The Internet Connection Setup Wizard is designed to guide you through a step-by-step process to configure your DIR-505 and connect to the Internet.

Click **Next** to continue.

WELCOME TO THE D-LINK INTERNET CONNECTION SETUP WIZARD

This wizard will guide you through a step-by-step process to configure your new D-Link router and connect to the Internet.

- Step 1: Set your Password
- Step 2: Select your Time Zone
- Step 3: Configure your Internet Connection
- Step 4: Save Settings and Connect

Prev Next Cancel Connect

In order to secure your router, please enter a new password. Click **Next** to continue.

STEP 1: SET YOUR PASSWORD

By default, your new D-Link Router does not have a password configured for administrator access to the Web-based configuration pages. To secure your new networking device, please set and verify a password below:

Password :

Verify Password :

Prev Next Cancel Connect

Select your time zone from the drop-down menu and click **Next** to continue.

STEP 2: SELECT YOUR TIME ZONE

Select the appropriate time zone for your location. This information is required to configure the time-based options for the router.

(GMT+08:00) Taipei

Prev Next Cancel Connect

Select your Internet connection type and click **Next** to continue.

STEP 3: CONFIGURE YOUR INTERNET CONNECTION

Your Internet Connection could not be detected, please select your Internet Service Provider (ISP) from the list below. If your ISP is not listed; select the "Not Listed or Don't Know" option to manually configure your connection.

Adelphia Power Link ▾

If your Internet Service Provider was not listed or you don't know who it is, please select the Internet connection type below

DHCP Connection (Dynamic IP Address)
Choose this if your Internet connection automatically provides you with an IP Address. Most Cable Modems use this type of connection.

Username / Password Connection (PPPoE)
Choose this option if your Internet connection requires a username and password to get online. Most DSL modems use this type of connection.

Username / Password Connection (PPTP)
PPTP client.

Username / Password Connection (L2TP)
L2TP client.

Static IP Address Connection
Choose this option if your Internet Setup Provider provided you with IP Address information that has to be manually configured.

Prev Next Cancel Connect

If you selected **DHCP Connection**, you will see the following screen. If your ISP requires you to enter a MAC address and Host Name, fill them in here. You can click the **Clone MAC button** to enter your current computer's MAC address.

Click **Next** to continue.

DHCP CONNECTION (DYNAMIC IP ADDRESS)

To set up this connection, please make sure that you are connected to the D-Link Router with the PC that was originally connected to your broadband connection. If you are, then click the Clone MAC button to copy your computer's MAC Address to the D-Link Router.

MAC Address : 00:00:00:00:00:00 (optional)
Clone Your PC's MAC address

Host Name : _____

You may also need to provide a Host Name. If you do not have or know this information, please contact your ISP.

Prev Next Cancel Connect

If you selected **PPPoE Connection**, you will see the following screen. Enter your PPPoE username, password and verify password, then click **Next** to continue.

Note: Make sure to remove your PPPoE software from your computer. The software is no longer needed and will not work through a router.

SET USERNAME / PASSWORD CONNECTION (PPPOE)

To set up this connection you will need to have a Username and Password from your Internet Service Provider. If you do not have this information, please contact your ISP.

Address Mode : Dynamic IP Static IP

IP Address :

User Name :

Password :

Verify Password :

Service Name : (optional)

Note: You may also need to provide a Service Name. If you do not have or know this information, please contact your ISP.

DNS SETTINGS

Primary DNS Address :

Secondary DNS Address :

If you selected **PPTP Connection**, you will see the following screen. Enter your PPTP username, password, and other information supplied by your ISP. Click **Next** to continue.

SET USERNAME / PASSWORD CONNECTION (PPTP)

To set up this connection you will need to have a Username and Password from your Internet Service Provider. You also need PPTP IP address. If you do not have this information, please contact your ISP.

Address Mode : Dynamic IP Static IP

PPTP IP Address :

PPTP Subnet Mask :

PPTP Gateway IP Address :

PPTP Server IP Address :

User Name :

Password :

Verify Password :

DNS SETTINGS

Primary DNS Address :

Secondary DNS Address :

If you selected **L2TP Connection**, you will see the following screen. Enter your L2TP username, password, and other information supplied by your ISP. Click **Next** to continue.

SET USERNAME / PASSWORD CONNECTION (L2TP)

To set up this connection you will need to have a Username and Password from your Internet Service Provider. You also need L2TP IP address. If you do not have this information, please contact your ISP.

Address Mode : Dynamic IP Static IP

L2TP IP Address :

L2TP Subnet Mask :

L2TP Gateway IP Address :

L2TP Server IP Address :

User Name :

Password :

Verify Password :

DNS SETTINGS

Primary DNS Address :

Secondary DNS Address :

If the router detected or you selected **Static**, enter the IP and DNS settings supplied by your ISP. Click **Next** to continue.

SET STATIC IP ADDRESS CONNECTION

To set up this connection you will need to have a complete list of IP information provided by your Internet Service Provider. If you have a Static IP connection and do not have this information, please contact your ISP.

IP Address :

Subnet Mask :

Gateway Address :

Primary DNS Address :

Secondary DNS Address :

Your setup is complete. Click **Connect** to save your settings and reboot your router.

SETUP COMPLETE!

The Internet Connection Setup Wizard has completed. Click the Connect button to save your settings and reboot the router.

Manual Internet Setup

If you clicked **Manual Internet Connection Setup** on the **Internet Settings** page, you will see this screen. Here, you can configure the Internet connection for your DIR-505. After making your changes, click the **Save Settings** button.

Operation Mode: This should be set to Router mode. If you want to use Access Point mode, select Access Point mode and click the Save Settings button to switch to the Access Point configuration interface. For more information, refer to "Access Point Mode" on page 74.

Host Name: Select the connection mode to use: **Dynamic IP (DHCP)**, **PPPoE**, **PPTP**, or **L2TP**. The remaining settings will change depending on which connection mode you use.

Note: Most cable modem connections use DHCP, and most DSL connections use PPPoE. If you are not sure which connection mode to use, contact your Internet service provider.

D-Link

DIR-505 // Router

SETUP ADVANCED MAINTENANCE STATUS HELP

INTERNET SETTINGS **WAN** Helpful Hints...

WIRELESS SETTINGS Use this section to configure your Internet Connection type. There are several connection types to choose from: Static IP, DHCP, PPPoE, PPTP, and L2TP. If you are unsure of your connection method, please contact your Internet Service Provider.

NETWORK SETTINGS **Note** : If using the PPPoE option, you will need to remove or disable any PPPoE client software on your computers.

MEDIA SERVER

STORAGE

OPERATION MODE SETTING

Operation Mode : Router

INTERNET CONNECTION TYPE

Choose the mode to be used by the router to connect to the Internet.

My Internet Connection is : Dynamic IP (DHCP)

DYNAMIC IP (DHCP) INTERNET CONNECTION TYPE :

Use this Internet connection type if your Internet Service Provider (ISP) didn't provide you with IP Address information and/or a username and password.

Host Name :

Use Unicasting : (compatibility for some DHCP Servers)

Primary DNS Server :

Secondary DNS Server :

MTU : (bytes) MTU default = 1500

MAC Address :

WIRELESS

Copyright © 2012 D-Link Corporation/D-Link Systems, Inc.

Helpful Hints...

When configuring the router to access the Internet, be sure to choose the correct **Internet Connection Type** from the drop down menu. If you are unsure of which option to choose, contact your **Internet Service Provider (ISP)**.

If you are having trouble accessing the Internet through the router, double check any settings you have entered on this page and verify them with your ISP if needed.

For added security, it is recommended that you disable the WAN Ping Respond option. Ping is often used by malicious Internet users to locate active networks or PCs.

If you are having trouble receiving multicast streams from the Internet, make sure the Multicast Streams option is enabled.

[More...](#)

If you selected **Dynamic IP (DHCP)**, you will see the following settings.

Host Name: Entering a host name is optional but may be required by some ISPs. Leave this blank if you are not sure.

Use UnICASTing: Check the box if you are having problems obtaining an IP address from your ISP.

Primary/Secondary DNS Server: Enter the Primary and secondary DNS server IP addresses assigned by your ISP. These addresses are usually obtained automatically from your ISP. Leave this setting at 0.0.0.0 if you did not specifically receive these from your ISP.

MTU: If you experience connection issues, you may need to change the MTU setting for optimal performance with your specific ISP. 1492 is the default MTU.

MAC Address: If your ISP requires you to enter a MAC address, fill it in here. You can click the **Clone MAC button** to enter your current computer's MAC address.

The screenshot shows the configuration interface for Dynamic IP (DHCP) Internet Connection Type. It includes a title bar, a header, a main instruction, a dropdown menu for the connection type, and a sub-section for Dynamic IP (DHCP) settings with various input fields and a button.

INTERNET CONNECTION TYPE

Choose the mode to be used by the router to connect to the Internet.

My Internet Connection is :

DYNAMIC IP (DHCP) INTERNET CONNECTION TYPE :

Use this Internet connection type if your Internet Service Provider (ISP) didn't provide you with IP Address information and/or a username and password.

Host Name :

Use UnICASTing : (compatibility for some DHCP Servers)

Primary DNS Server :

Secondary DNS Server :

MTU : (bytes) MTU default = 1500

MAC Address :

If you selected **PPPoE**, you will see the following settings. Your ISP will provide you with a username and password. This option is typically used for DSL services. Make sure to remove your PPPoE software from your computer. The software is no longer needed and will not work through a router.

Address Mode: Select **Static IP** if your ISP assigned you an IP address, subnet mask, gateway, and DNS server address. In most cases, select **Dynamic IP**.

IP Address: Enter the IP address (for static PPPoE only).

User Name: Enter your PPPoE user name.

Password: Enter your PPPoE password and then retype the password in the next box.

Service Name: Enter the ISP service name (optional).

Reconnect Mode: Select either **Always-on**, **On-Demand**, or **Manual**.

Maximum Idle Time: Enter a maximum idle time during which the Internet connection is maintained during inactivity. To disable this feature, set the **Reconnect Mode** to **Always on**.

Primary/Secondary DNS Server: Enter the primary and secondary DNS server addresses (Static PPPoE only).

MTU: If you experience connection issues, you may need to change the MTU setting for optimal performance with your specific ISP. 1492 is the default MTU.

INTERNET CONNECTION TYPE

Choose the mode to be used by the router to connect to the Internet.

My Internet Connection is : ▼

PPPOE INTERNET CONNECTION TYPE :

Enter the information provided by your Internet Service Provider (ISP).

Address Mode : Dynamic IP Static IP

IP Address :

Username :

Password :

Verify Password :

Service Name : (optional)

Reconnect Mode : Always on On demand Manual

Maximum Idle Time : (minutes, 0=infinite)

Primary DNS Server : (optional)

Secondary DNS Server : (optional)

MTU : (bytes) MTU default = 1492

MAC Address :

MAC Address: If your ISP requires you to enter a MAC address, fill it in here. You can click the **Clone MAC button** to enter your current computer's MAC address.

INTERNET CONNECTION TYPE

Choose the mode to be used by the router to connect to the Internet.

My Internet Connection is : ▼

PPPOE INTERNET CONNECTION TYPE :

Enter the information provided by your Internet Service Provider (ISP).

Address Mode : Dynamic IP Static IP

IP Address :

Username :

Password :

Verify Password :

Service Name : (optional)

Reconnect Mode : Always on On demand Manual

Maximum Idle Time : (minutes, 0=infinite)

Primary DNS Server : (optional)

Secondary DNS Server : (optional)

MTU : (bytes) MTU default = 1492

MAC Address :

If you selected **PPTP**, you will see the following settings. Your ISP will provide you with a username and password. This option is typically used for DSL services.

Address Mode: Select **Static** if your ISP assigned you an IP address, subnet mask, gateway, and DNS server address. In most cases, select **Dynamic**.

PPTP IP Address: Enter the IP address (Static PPTP only).

PPTP Subnet Mask: Enter the primary and secondary DNS server addresses (for static PPTP only).

PPTP Gateway IP Address: Enter the gateway IP address provided by your ISP.

PPTP Server IP Address: Enter the server IP provided by your ISP (optional).

Username: Enter your PPTP username.

Password: Enter your PPTP password and then retype the password in the next box.

Reconnect Mode: Select either **Always-on**, **On-Demand**, or **Manual**.

Maximum Idle Time: Enter a maximum idle time during which the Internet connection is maintained during inactivity. To disable this feature, set the **Reconnect Mode** to **Always on**.

INTERNET CONNECTION TYPE

Choose the mode to be used by the router to connect to the Internet.

My Internet Connection is : ▼

PPTP INTERNET CONNECTION TYPE :

Enter the information provided by your Internet Service Provider (ISP).

Address Mode : Dynamic IP Static IP

PPTP IP Address :

PPTP Subnet Mask :

PPTP Gateway IP Address :

PPTP Server IP Address :

Username :

Password :

Verify Password :

Reconnect Mode : Always on On demand Manual

Maximum Idle Time : (minutes, 0=infinite)

Primary DNS Server :

Secondary DNS Server :

MTU : (bytes) MTU default = 1492

MAC Address :

Primary/Secondary DNS Server: The DNS server information will be supplied by your ISP (Internet Service Provider.)

MTU: If you experience connection issues, you may need to change the MTU setting for optimal performance with your specific ISP. 1492 is the default MTU.

MAC Address: If your ISP requires you to enter a MAC address, fill it in here. You can click the **Clone MAC button** to enter your current computer's MAC address.

INTERNET CONNECTION TYPE

Choose the mode to be used by the router to connect to the Internet.

My Internet Connection is : PPTP (Username / Password) ▼

PPTP INTERNET CONNECTION TYPE :

Enter the information provided by your Internet Service Provider (ISP).

Address Mode : Dynamic IP Static IP

PPTP IP Address :

PPTP Subnet Mask :

PPTP Gateway IP Address :

PPTP Server IP Address :

Username :

Password :

Verify Password :

Reconnect Mode : Always on On demand Manual

Maximum Idle Time : (minutes, 0=infinite)

Primary DNS Server :

Secondary DNS Server :

MTU : (bytes) MTU default = 1492

MAC Address :

If you selected **L2TP**, you will see the following settings. Your ISP will provide you with a username and password. This option is typically used for DSL services.

My Internet Connection: Select **L2TP (Username/Password)** from the drop-down menu.

Address Mode: Select **Static** if your ISP assigned you the IP address, subnet mask, gateway, and DNS server addresses. In most cases, select **Dynamic**.

L2TP IP Address: Enter the L2TP IP address supplied by your ISP (for static IP only).

L2TP Subnet Mask: Enter the subnet mask supplied by your ISP (for static IP only).

L2TP Gateway IP Address: Enter the gateway IP Address provided by your ISP.

L2TP Server IP Address: Enter the server IP provided by your ISP (optional).

Username: Enter your L2TP username.

Password: Enter your L2TP password and then retype the password in the next box.

Reconnect Mode: Select either **Always-on**, **On-Demand**, or **Manual**.

Maximum Idle Time: Enter a maximum idle time during which the Internet connection is maintained during inactivity. To disable this feature, set the **Reconnect Mode** to **Always on**.

INTERNET CONNECTION TYPE

Choose the mode to be used by the router to connect to the Internet.

My Internet Connection is : ▼

L2TP INTERNET CONNECTION TYPE :

Enter the information provided by your Internet Service Provider (ISP).

Address Mode : Dynamic IP Static IP

L2TP IP Address :

L2TP Subnet Mask :

L2TP Gateway IP Address :

L2TP Server IP Address :

Username :

Password :

Verify Password :

Reconnect Mode : Always on On demand Manual

Maximum Idle Time : (minutes, 0=infinite)

Primary DNS Server :

Secondary DNS Server :

MTU : (bytes) MTU default = 1492

MAC Address :

Primary/Secondary DNS Server: Enter the primary and secondary DNS server addresses (for static L2TP only).

MTU: If you experience connection issues, you may need to change the MTU setting for optimal performance with your specific ISP. 1492 is the default MTU.

MAC Address: If your ISP requires you to enter a MAC address, fill it in here. You can click the **Clone MAC button** to enter your current computer's MAC address.

INTERNET CONNECTION TYPE

Choose the mode to be used by the router to connect to the Internet.

My Internet Connection is : L2TP (Username / Password) ▼

L2TP INTERNET CONNECTION TYPE :

Enter the information provided by your Internet Service Provider (ISP).

Address Mode : Dynamic IP Static IP

L2TP IP Address :

L2TP Subnet Mask :

L2TP Gateway IP Address :

L2TP Server IP Address :

Username :

Password :

Verify Password :

Reconnect Mode : Always on On demand Manual

Maximum Idle Time : (minutes, 0=infinite)

Primary DNS Server :

Secondary DNS Server :

MTU : (bytes) MTU default = 1492

MAC Address :

Wireless Settings

If you want to configure the wireless settings on your router using the wizard, click **Wireless Security Setup Wizard** and refer to the next page.

If you want to manually configure the wireless settings on your router click **Manual Wireless Network Setup** and refer to “Manual Wireless Network Configuration” on page 41.

The screenshot displays the D-Link DIR-505 Router Web Management Interface. The top navigation bar includes the D-Link logo and tabs for SETUP, ADVANCED, MAINTENANCE, STATUS, and HELP. The left sidebar lists menu items: INTERNET SETTINGS, WIRELESS SETTINGS (highlighted), NETWORK SETTINGS, MEDIA SERVER, and STORAGE. The main content area is titled "WIRELESS SETTINGS" and contains the following sections:

- WIRELESS SETTINGS**: A header section with a sub-header "WIRELESS SETTINGS" and a description: "The following Web-based wizards are designed to assist you in your wireless network setup and wireless device connection. Before launching these wizards, please make sure you have followed all steps outlined in the Quick Installation Guide included in the package." Below this is a button labeled "Wireless Network Setup Wizard".
- WIRELESS NETWORK SETUP WIZARD**: A section with a description: "This wizard is designed to assist you in your wireless network setup. It will guide you through step-by-step instructions on how to set up your wireless network and how to make it secure." Below this is a button labeled "Wireless Network Setup Wizard". A **Note** states: "Some changes made using this Setup Wizard may require you to change some settings on your wireless client adapters so they can still connect to the D-Link Router."
- MANUAL WIRELESS NETWORK SETUP**: A section with a description: "If your wireless network is already set up with Wi-Fi Protected Setup, manual configuration of the wireless network will destroy the existing wireless network. If you would like to configure the wireless settings of your new D-Link Router manually, then click on the Manual Wireless Network Setup button below." Below this is a button labeled "Manual Wireless Network Setup".

On the right side of the interface, there is a "Helpful Hints..." section with text: "If you are new to wireless networking and have never configured a wireless router before, click on **Wireless Network Setup Wizard** and the router will guide you through a few simple steps to get your wireless network up and running. If you consider yourself an advanced user and have configured a wireless router before, click **Manual Wireless Network Setup** to input all the settings manually." Below this is a "More..." link. At the bottom of the page, the word "WIRELESS" is displayed in a large font, and the footer contains the copyright notice: "Copyright © 2012 D-Link Corporation/D-Link Systems, Inc."

Wireless Network Setup Wizard

The Internet Connection Setup Wizard is designed to guide you through a step-by-step process to configure your wireless network.

Type your desired wireless network name (SSID) and choose from the following options:

Automatically assign a network key (Recommended):

Select this option to automatically generate the router's network key and click **Next**.

Manually assign a network key: Select this option to manually enter your network key and click **Next**.

It is also recommended that you tick the **Use WPA encryption instead of WEP** checkbox in order to give your wireless network the highest level of security.

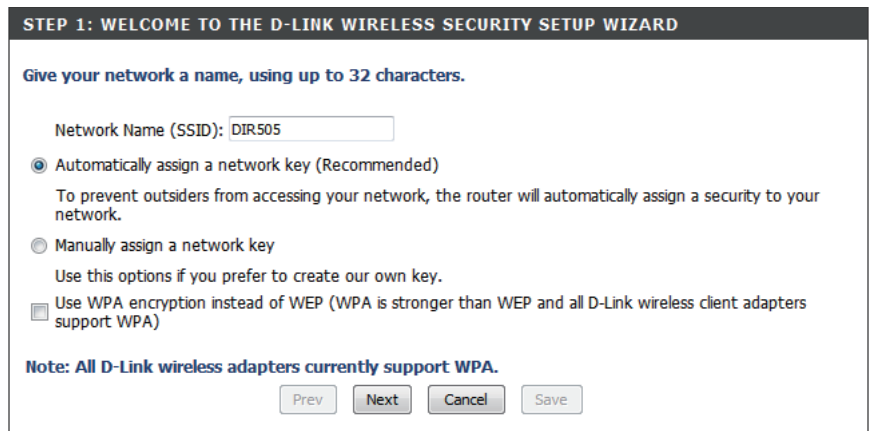
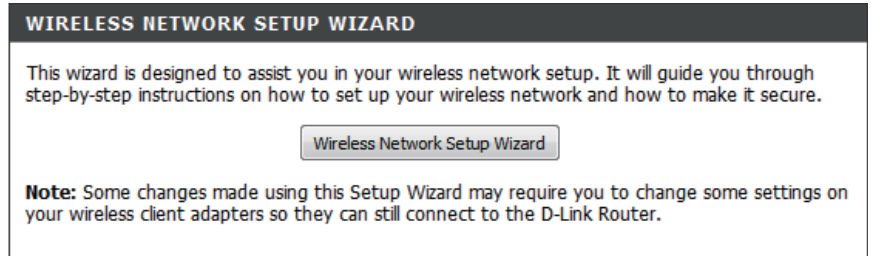

If you selected **Manually assign a network key**, you will need to manually enter a password (network key) for your wireless network, and then click **Next**.

STEP 2: SET YOUR WIRELESS SECURITY PASSWORD

You have selected your security level - you will need to set a wireless security password.

The WPA (Wi-Fi Protected Access) key must meet one of following guidelines:

- Between 8 and 63 characters (A longer WPA key is more secure than a short one)

Wireless Security Password :

Note: You will need to enter the same password as keys in this step into your wireless clients in order to enable proper wireless communication.

Wireless setup is now complete. Click **Save** to save your settings and complete the setup process.

SETUP COMPLETE!

Below is a detailed summary of your wireless security settings. Please print this page out, or write the information on a piece of paper, so you can configure the correct settings on your wireless client adapters.

Network Name (SSID): DIR505
Security Mode : Auto (WPA or WPA2) - Personal
Cipher Type TKIP and AES
Pre-Shared Key : 12345678

Manual Wireless Network Configuration

If you clicked **Manual Wireless Network Setup** on the **Wireless Settings** page, you will see this screen. Here, you can configure the wireless network settings of the DIR-505. After making your changes, click the **Save Settings** button.

Wireless Network Name: When you are browsing for available wireless networks, this is the name that will appear in the list (unless Visibility Status is set to Invisible, see below). This name is also referred to as the SSID. For security purposes, it is highly recommended to change from the default network name.

802.11 Mode: Select one of the following based on your needs:

- **802.11b Only:** Select this if you are only using 802.11b wireless clients.
- **802.11g Only:** Select this if you are only using 802.11g wireless clients.
- **802.11n Only:** Select this if you are only using 802.11n wireless clients.
- **Mixed 802.11g and 802.11b:** Select this if you are using a mix of 802.11g and 11b wireless clients.
- **Mixed 802.11n and 802.11g:** Select this if you are using a mix of 802.11n and 11g wireless clients.
- **Mixed 802.11n, 802.11g and 802.11b:** Select this if you are using a mix of 802.11n, 11g, and 11b wireless clients.

Enable Auto Channel Scan: The **Auto Channel Scan** setting can be selected to allow the DIR-505 to choose the channel with the least amount of interference.

Wireless Channel: Indicates the channel setting for the DIR-505. The Channel can be changed to fit the channel setting for an existing wireless network or to customize the wireless network. If you enable Auto Channel Scan, this option will be grayed out.

DIR-505 Router | SETUP | ADVANCED | MAINTENANCE | STATUS | HELP

WIRELESS

Use this section to configure the wireless settings for your D-Link Router. Please note that changes made on this section may also need to be duplicated on your Wireless Client.

Save Settings | Don't Save Settings

WIRELESS NETWORK SETTINGS

Wireless Network Name: MobileCompanion-Claire (Also called the SSID)

Wireless Band: 2.4GHz

802.11 Mode: Mixed 802.11n, 802.11g and 802.11b

Enable Auto Channel Scan:

Wireless Channel: 2.412 GHz - CH 1

Channel Width: Auto 20/40 MHz

Visibility Status: Visible Invisible

WIRELESS SECURITY MODE

Security Mode: WPA-Personal

WPA

Use WPA or WPA2 mode to achieve a balance of strong security and best compatibility. This mode uses WPA for legacy clients while maintaining higher security with stations that are WPA2 capable. Also the strongest cipher that the client supports will be used. For best security, use WPA2 Only mode. This mode uses AES(CCMP) cipher and legacy stations are not allowed access with WPA security. For maximum compatibility, use WPA Only. This mode uses TKIP cipher. Some gaming and legacy devices work only in this mode.

To achieve better wireless performance use WPA2 Only security mode (or in other words AES cipher).

WPA Mode: Auto (WPA or WPA2)

Cipher Type: TKIP and AES

PRE-SHARED KEY

Enter an 8 to 63 character alphanumeric pass-phrase. For good security it should be of ample length and should not be a commonly known phrase.

Pre-Shared Key:

WIRELESS

Copyright © 2012 D-Link Corporation/D-Link Systems, Inc.

Helpful Hints...

Changing your Wireless Network Name is the first step in securing your wireless network. Change it to a familiar name that does not contain any personal information.

Enable Auto Channel Scan so that the router can select the best possible channel for your wireless network to operate on.

Visibility Status is another way to secure your network. With invisible option enabled, no wireless clients will be able to see your wireless network when they perform scan to see what's available. In order for your wireless devices to connect to your AP, you will need to manually enter the Wireless Network Name on each device.

If you have enabled Wireless Security, make sure you write down the Key or Passphrase that you have configured. You will need to enter this information on any wireless device that you connect to your wireless network.

More...

Channel Width: Select whether to use **Auto 20/40 MHz** or **20 MHz** for the channel width. Normally, this should be left on **Auto 20/40 MHz**. If you are not using any 802.11n wireless clients, you can set this to **20 MHz**.

Visibility Status: This setting controls whether the router's wireless network name (SSID) will be broadcast so that wireless devices can scan for it. If you set it to **Invisible**, all wireless clients will need to enter the network name and security settings of your wireless network manually.

Wireless Security Mode: Here, you can select between **None**, **WEP**, **WPA-Personal**, and **WPA-Enterprise**. Refer to the following pages for details on configuring the different security modes.

WIRELESS NETWORK SETTINGS	
Wireless Network Name :	MobileCompanion-Claire- (Also called the SSID)
Wireless Band :	2.4GHz
802.11 Mode :	Mixed 802.11n, 802.11g and 802.11b
Enable Auto Channel Scan :	<input checked="" type="checkbox"/>
Wireless Channel :	2.412 GHz - CH 1
Channel Width :	Auto 20/40 MHz
Visibility Status :	<input checked="" type="radio"/> Visible <input type="radio"/> Invisible

WIRELESS SECURITY MODE	
Security Mode :	WPA-Personal

If you select **WEP** as your Security Mode:

WEP Key Select an encryption level and key length to use. This will
Length: also set the type and length of the key you will need to enter.

WEP Key: Enter the password(key) for your wireless network. It will
 need to match the requirements for the WEP Key Length
 selected above.

Authentication: Choose what Authentication type to use.

WIRELESS SECURITY MODE

Security Mode :

WEP

WEP is the wireless encryption standard. To use it you must enter the same key(s) into the router and the wireless stations. For 64 bit keys you must enter 10 hex digits into each key box. For 128 bit keys you must enter 26 hex digits into each key box. A hex digit is either a number from 0 to 9 or a letter from A to F. For the most secure use of WEP set the authentication type to "Shared Key" when WEP is enabled.

You may also enter any text string into a WEP key box, in which case it will be converted into a hexadecimal key using the ASCII values of the characters. A maximum of 5 text characters can be entered for 64 bit keys, and a maximum of 13 characters for 128 bit keys.

If you choose the WEP security option this device will **ONLY** operate in **Legacy Wireless mode (802.11B/G)**. This means you will **NOT** get 11N performance due to the fact that WEP is not supported by the Draft 11N specification.

WEP Key Length : (length applies to all keys)

WEP Key 1 :

Authentication :

If you select **WPA-Personal** as your Security Mode:

WPA Mode: Select whether to use **WPA, WPA2**, or both **WPA and WPA2**
 for your wireless network..

Cipher Type: Choose whether to use **TKIP, AES**, or both **TKIP and AES**
 ciphers for your wireless network.

Pre-Shared Key: Enter the password(key) for your wireless network.

WIRELESS SECURITY MODE

Security Mode :

WPA

Use **WPA or WPA2** mode to achieve a balance of strong security and best compatibility. This mode uses WPA for legacy clients while maintaining higher security with stations that are WPA2 capable. Also the strongest cipher that the client supports will be used. For best security, use **WPA2 Only** mode. This mode uses AES(CCMP) cipher and legacy stations are not allowed access with WPA security. For maximum compatibility, use **WPA Only**. This mode uses TKIP cipher. Some gaming and legacy devices work only in this mode.

To achieve better wireless performance use WPA2 Only security mode (or in other words AES cipher).

WPA Mode :

Cipher Type :

PRE-SHARED KEY

Enter an 8 to 63 character alphanumeric pass-phrase. For good security it should be of ample length and should not be a commonly known phrase.

Pre-Shared Key :

If you select **WPA-Enterprise** as your Security Mode:

WPA Mode: Select whether to use **WPA**, **WPA2**, or both **WPA and WPA2** for your wireless network..

Cipher Type: Choose whether to use **TKIP**, **AES**, or both **TKIP and AES** ciphers for your wireless network.

Pre-Shared Key: Enter the password(key) for your wireless network.

RADIUS Server IP Address: Enter your RADIUS server IP address.

RADIUS Server Port: Enter your RADIUS server port.

RADIUS Server Shared Secret: Enter your RADIUS server shared secret.

WIRELESS SECURITY MODE

Security Mode :

WPA

Use **WPA** or **WPA2** mode to achieve a balance of strong security and best compatibility. This mode uses WPA for legacy clients while maintaining higher security with stations that are WPA2 capable. Also the strongest cipher that the client supports will be used. For best security, use **WPA2 Only** mode. This mode uses AES(CCMP) cipher and legacy stations are not allowed access with WPA security. For maximum compatibility, use **WPA Only**. This mode uses TKIP cipher. Some gaming and legacy devices work only in this mode.

To achieve better wireless performance use WPA2 Only security mode (or in other words AES cipher).

WPA Mode :

Cipher Type :

EAP (802.1X)

When WPA enterprise is enabled, the router uses EAP (802.1x) to authenticate clients via a remote RADIUS server.

RADIUS Server IP Address :

RADIUS Server Port :

RADIUS Server Shared Secret :

Network Settings

This section will allow you to change the local network settings of the router and to configure the DHCP settings. After making your changes, click the **Save Settings** button.

Router Settings

Router IP Address: Enter the IP address of the router. The default IP address is 192.168.0.1.

If you change the IP address, once you click **Save Settings**, you will need to enter the new IP address in your browser to get back into the configuration utility.

Subnet Mask: Enter the Subnet Mask. The default subnet mask is 255.255.255.0.

Device Name: Enter a name for the DIR-505.

Local Domain: Enter the Domain name (Optional).

Enable DNS Relay: Uncheck the box to transfer the DNS server information from your ISP to your computers. If checked, your computers will use the router for a DNS server.

The screenshot shows the D-Link DIR-505 Router Web Management Interface. The main navigation tabs are SETUP, ADVANCED, MAINTENANCE, STATUS, and HELP. The current page is NETWORK SETTINGS, which includes sections for ROUTER SETTINGS, DHCP SERVER SETTINGS, ADD DHCP RESERVATION, and DHCP RESERVATIONS LIST.

NETWORK SETTINGS

Use this section to configure the internal network settings of your router and also to configure the built-in DHCP Server to assign IP addresses to the computers on your network. The IP Address that is configured here is the IP Address that you use to access the Web-based management interface. If you change the IP Address here, you may need to adjust your PC's network settings to access the network again.

Save Settings Don't Save Settings

ROUTER SETTINGS

Use this section to configure the internal network settings of your router. The IP Address that is configured here is the IP Address that you use to access the Web-based management interface. If you change the IP Address here, you may need to adjust your PC's network settings to access the network again.

Router IP Address : 192.168.0.1
 Subnet Mask : 255.255.255.0
 Device Name : dlinkrouter
 Local Domain Name : (optional)
 Enable DNS Relay :

DHCP SERVER SETTINGS

Use this section to configure the built-in DHCP Server to assign IP addresses to the computers on your network.

Enable DHCP Server :
 DHCP IP Address Range : 192.168.0.100 to 192.168.0.199
 DHCP Lease Time : 1440 (minutes)

ADD DHCP RESERVATION

Enable :
 Computer Name : << Computer Name >>
 IP Address :
 MAC Address :
 Clone Your PC's MAC address
 Save Clear

DHCP RESERVATIONS LIST

Enable	Computer Name	MAC Address	IP Address
<input checked="" type="checkbox"/>	DOCNBWINXPE	00:19:d2:8f:a0:2e	192.168.0.100

NUMBER OF DYNAMIC DHCP CLIENTS:

Hardware Address	Assigned IP	Hostname	Expires
00:19:d2:8f:a0:2e	192.168.0.100	DOCNBWINXPE	Sun Jan 2 00:01:12 2011 Revoke Reserve
28:e0:2c:dc:0a:be	192.168.0.101	UNKNOWN	Sun Jan 2 00:05:07 2011 Revoke Reserve

Helpful Hints...

If you already have a DHCP server on your network or are using static IP addresses on all the devices on your network, uncheck **Enable DHCP Server** to disable this feature.

If you have devices on your network that should always have fixed IP addresses, add a **DHCP Reservation** for each such device.

More...

DHCP Reservation

If you want a computer or device to always have the same IP address assigned, you can create a DHCP reservation. The router will assign the IP address only to that computer or device.

Note: This IP address must be within the DHCP IP Address Range.

Enable: Check this box to enable the reservation.

Computer Name: Enter a name for your computer. You can also use the dropdown box to the right to select a currently connected computer, and then click the << button to automatically fill in the text boxes with your computer's information.

IP Address: Enter the IP address you want to assign to the computer or device. This IP Address must be within the **DHCP IP Address Range**.

MAC Address: Enter the MAC address of the computer or device.

Clone Your PC's MAC Address: You can click this button to automatically add the MAC address of the computer that you are currently using.

Save: Click **Save** to save your DHCP reservation. You will still need to click **Save Settings** at the top of the screen to activate your DHCP reservations.

DHCP SERVER SETTINGS

Use this section to configure the built-in DHCP Server to assign IP addresses to the computers on your network.

Enable DHCP Server :

DHCP IP Address Range : to

DHCP Lease Time : (minutes)

ADD DHCP RESERVATION

Enable :

Computer Name : << ▼

IP Address :

MAC Address :

DHCP Reservations This section shows your DHCP reservations. The list shows Computer Name, MAC Address, and IP address for each reservation.

Enable: Check to enable the reservation.

Edit: Click the edit icon (✎) to make changes to the reservation entry.

Delete: Click to remove the reservation from the list.

Number of Dynamic DHCP Clients: This section shows you all devices that have been assigned an IP address. You can click the **Revoke** link for a device to revoke its IP address, which will cut off the device's access to your network. You can also click the **Reserve** link to automatically fill in the **Add DHCP Reservation** form with that computer's information.

DHCP RESERVATIONS LIST					
Enable	Computer Name	MAC Address	IP Address		
<input checked="" type="checkbox"/>	DOCNBWINXPE	00:19:d2:8f:a0:2e	192.168.0.100		

NUMBER OF DYNAMIC DHCP CLIENTS:					
Hardware Address	Assigned IP	Hostname	Expires		
00:19:d2:8f:a0:2e	192.168.0.100	DOCNBWINXPE	Sun Jan 2 00:01:12 2011	Revoke	Reserve
28:e0:2c:dc:0a:be	192.168.0.101	UNKNOWN	Sun Jan 2 00:05:07 2011	Revoke	Reserve

Media Server

This feature allows you to share music, pictures and videos with any devices connected to your network. After making your changes, click the **Save Settings** button.

Enable Media Server: Check this box to enable the media server feature.

Computer Name: Enter the media server's name.

The screenshot displays the D-Link DIR-505 Router Web Interface. The top navigation bar includes the D-Link logo and tabs for SETUP, ADVANCED, MAINTENANCE, STATUS, and HELP. The left sidebar lists various settings categories: INTERNET SETTINGS, WIRELESS SETTINGS, NETWORK SETTINGS, MEDIA SERVER, and STORAGE. The main content area is titled "MEDIA SERVER" and contains the following text: "Enable DLNA Media Server allows you to share media with DLNA certified devices. Any DLNA certified devices that connect to your network can play your shared music, pictures, and videos." Below this is a note: "Note: The shared media may not be secure. Allowing any devices to stream is recommended only on secure networks." There are two buttons: "Save Settings" and "Don't Save Settings". Under the "DLNA MEDIA SERVER" section, there is a checkbox for "Enable DLNA Media Server" which is checked, and a text input field for "Media Server Name" containing the value "DIR-505". The bottom of the page features a "WIRELESS" section header and a copyright notice: "Copyright © 2012 D-Link Corporation/D-Link Systems, Inc."

Storage

This page will allow you to access files from a USB external hard drive or thumb drive that is plugged into the DIR-505 from your local network or from the Internet using either a web browser or the SharePort Mobile app for your smartphone or tablet. You can create users to customize access rights to the files stored on the USB drive. After making your changes, click the **Save Settings** button.

Enable Shareport Web Access: Tick this checkbox to enable sharing files stored on a USB storage drive connected to the DIR-505.

HTTP Access Port: Enter a port to use for HTTP web access to your files (8181 is the default). You will have to add this port to the IP address of the DIR-505 when connecting. For example: `http://192.168.0.1:8181`

HTTPS Access Port: Enter a port to use for HTTPS secure access to your files (4433 is the default). You will have to add this port to the IP address of the DIR-505 when connecting. For example: `https://192.168.0.1:4433`

Allow Remote Access: Check to enable remote access to your router's storage.

User Name: To create a new user, enter a user name. To edit an existing user, use the dropdown box to the right.

Password/Verify Password: Enter a password you want to use for the account, re-enter the password in the **Verify Password** text box, then click **Add/Edit** to save your changes.

User List: This section shows existing user accounts. There are **admin** and **guest** accounts by default.

D-Link

DIR-505 // Router

SETUP ADVANCED MAINTENANCE STATUS HELP

INTERNET SETTINGS WIRELESS SETTINGS NETWORK SETTINGS MEDIA SERVER STORAGE

STORAGE

Share Port Web Access allows you to use a web browser to access files stored on an USB storage drive plugged into the router. To use this feature, check the **Enable SharePort Web Access** checkbox, then create user accounts to manage access to your storage devices or use the Guest account(guest/guest) to access the Guest Folder. After plugging in an USB storage drive, the new device will appear in the list with a link to it. You can then use this link to connect to the drive and log in with a user account.

Save Settings Don't Save Settings

SHAREPORT WEB ACCESS

Enable SharePort Web Access:

HTTP Access Port: 8181

HTTPS Access Port: 4433

Allow Remote Access:

10 -- USER CREATION

User Name: << User Name

Password:

Verify Password: Add/Edit Delete

USER LIST

No.	User Name	Access Path	Permission	Modify	Delete
1	admin	/	Read/Write		
2	guest	(1) /usb_A1	Read Only		
3	wrpd	(1) /usb_A1/IPhone4	Read Only		
4	test	(1) /usb_A1/Music	Read/Write		

NUMBER OF DEVICES : 0

Device	Total Space	Free Space

SHAREPORT WEB ACCESS LINK

You can use this link to connect to the drive remotely after logging in with a user account.

WIRELESS

Number of Devices: This section shows you information about the USB storage device plugged into the router.

SharePort Web Access Link This will give you a direct link to the web access interface that you can click on or copy and paste.

The screenshot shows the D-Link DIR-505 Router web interface. The top navigation bar includes tabs for SETUP, ADVANCED, MAINTENANCE, STATUS, and HELP. The left sidebar lists various settings categories: INTERNET SETTINGS, WIRELESS SETTINGS, NETWORK SETTINGS, MEDIA SERVER, and STORAGE. The main content area is titled 'STORAGE' and contains the following sections:

- STORAGE:** A text box explaining SharePort Web Access and buttons for 'Save Settings' and 'Don't Save Settings'.
- SHAREPORT WEB ACCESS:** A form with 'Enable SharePort Web Access' (checked), 'HTTP Access Port' (8181), 'HTTPS Access Port' (4433), and 'Allow Remote Access' (unchecked).
- 10 -- USER CREATION:** A form for creating a user with fields for 'User Name', 'Password', and 'Verify Password', along with 'Add/Edit' and 'Delete' buttons.
- USER LIST:** A table listing users and their access paths.

No.	User Name	Access Path	Permission	Modify	Delete
1	admin	/	Read/Write		
2	guest	(1) /usb_A1	Read Only		
3	wrpd	(1) /usb_A1/IPhone4	Read Only		
4	test	(1) /usb_A1/Music	Read/Write		
- NUMBER OF DEVICES : 0:** A summary section with a table for device statistics.

Device	Total Space	Free Space
- SHAREPORT WEB ACCESS LINK:** A text box providing a link to connect to the drive remotely.

The bottom of the page features a 'WIRELESS' section and a copyright notice: 'Copyright © 2012 D-Link Corporation/D-Link Systems, Inc.'

Advanced Virtual Server

This will allow you to open a single port. If you would like to open a range of ports, refer to “Application Rules” on page 52. After making your changes, click the **Save Settings** button.

Name: Enter a name for the rule or select an application from the drop-down menu and click << to automatically fill in the rule with the default settings for that application.

IP Address: Enter the IP address of the computer on your local network that you want to allow the incoming service to. If your computer is receiving an IP address automatically from the router (DHCP), your computer will be listed in the **Computer Name** drop-down menu. Select your computer and click the << button to automatically fill in the IP address.

Private Port/ Public Port: Enter the port that you want to open next to Private Port and Public Port. The private and public ports are usually the same. The public port is the port seen from the Internet side, and the private port is the port being used by the application on the computer within your local network.

Protocol Type: Select **TCP**, **UDP**, or **Both** from the drop-down menu.

D-Link

DIR-505 Router

SETUP ADVANCED MAINTENANCE STATUS HELP

VIRTUAL SERVER

The Virtual Server option allows you to define a single public port on your router for redirection to an internal LAN IP Address and Private LAN port if required. This feature is useful for hosting online services such as FTP or Web Servers.

Save Settings Don't Save Settings

8--VIRTUAL SERVERS LIST

		Port	Traffic Type
<input type="checkbox"/>	Name Application Name	Public 0	Protocol TCP
	IP Address 0.0.0.0 Computer Name	Private 0	6
<input type="checkbox"/>	Name Application Name	Public 0	Protocol TCP
	IP Address 0.0.0.0 Computer Name	Private 0	6
<input type="checkbox"/>	Name Application Name	Public 0	Protocol TCP
	IP Address 0.0.0.0 Computer Name	Private 0	6
<input type="checkbox"/>	Name Application Name	Public 0	Protocol TCP
	IP Address 0.0.0.0 Computer Name	Private 0	6
<input type="checkbox"/>	Name Application Name	Public 0	Protocol TCP
	IP Address 0.0.0.0 Computer Name	Private 0	6
<input type="checkbox"/>	Name Application Name	Public 0	Protocol TCP
	IP Address 0.0.0.0 Computer Name	Private 0	6

Helpful Hints...

Check the **Application Name** drop down menu for a list of predefined server types. If you select one of the predefined server types, click the arrow button next to the drop down menu to fill out the corresponding field.

You can select a computer from the list of DHCP clients in the **Computer Name** drop down menu, or you can manually enter the IP address of the computer at which you

WIRELESS

Copyright © 2012 D-Link Corporation/D-Link Systems, Inc.

Application Rules

Some applications may require multiple connections, such as Internet gaming, video conferencing, and VoIP calls over the Internet. These applications may have difficulty working through NAT (Network Address Translation). Application Rules allow some of these applications work with the DIR-505. If you need to run applications that require multiple connections, specify the port normally associated with the application in the **Trigger Port** setting, select the protocol type as **TCP** or **UDP**, then enter the **Firewall** (public) ports associated with the trigger port to open them for inbound traffic. After making your changes, click the **Save Settings** button.

Name: Enter a name for the rule or select an application from the drop-down menu and click << to automatically fill in the rule with the default settings for that application.

Trigger: This is the port used to trigger the application. It can be either a single port or a range of ports.

Traffic Type: Select the protocol of the trigger port (TCP, UDP, or Both).

Firewall: This is the port number on the Internet side that will be used to access the application. You may define a single port or a range of ports. You can use a comma to add multiple ports or port ranges.

Traffic Type: Select the protocol of the firewall port (TCP, UDP, or Both).

D-Link

DIR-505 Router

SETUP ADVANCED MAINTENANCE STATUS HELP

APPLICATION RULES

This option is used to open single or multiple ports on your router when the router senses data sent to the Internet on a "trigger" port or port range. Special Applications rules apply to all computers on your internal network.

Save Settings Don't Save Settings

8 -- APPLICATION RULES

	Name	Application	Port	Traffic Type
<input type="checkbox"/>		<< Application Name	Trigger Firewall	TCP
<input type="checkbox"/>		<< Application Name	Trigger Firewall	TCP
<input type="checkbox"/>		<< Application Name	Trigger Firewall	TCP
<input type="checkbox"/>		<< Application Name	Trigger Firewall	TCP
<input type="checkbox"/>		<< Application Name	Trigger Firewall	TCP
<input type="checkbox"/>		<< Application Name	Trigger Firewall	TCP
<input type="checkbox"/>		<< Application Name	Trigger Firewall	TCP
<input type="checkbox"/>		<< Application Name	Trigger Firewall	TCP

Helpful Hints...
Use this feature if you are trying to execute one of the listed network applications and it is not communicating as expected.
Check the Application Name drop down menu for a list of predefined applications. If you select one of the predefined applications, click the arrow button next to the drop down menu to fill out the corresponding field.
More...

WIRELESS

Copyright © 2012 D-Link Corporation/D-Link Systems, Inc.

MAC Address Filter

Use MAC (Media Access Control) Filters to control access to your network based on the MAC addresses of connected clients. You can set MAC address filtering to only allow the listed MAC addresses to connect, or block access to all listed MAC addresses. After making your changes, click the **Save Settings** button.

Wireless Access Settings: Configure how MAC filtering works by using the dropdown box to select an option:

Turn MAC Filtering OFF: This disables MAC filtering.

Turn MAC Filtering ON and ALLOW computers listed to access the network: When this option is selected, only PCs and devices with MAC addresses in the MAC Address List are granted network access. All other devices will be blocked.

Turn MAC Filtering ON and DENY computers listed to access the network: When this option is selected, all PCs and devices with MAC addresses in the MAC Address List will be refused access to your network. All other devices will be allowed access.

MAC Address: Enter the MAC addresses you would like to filter. You can select a client currently connected to your access point from the **Wireless Client List** drop-down menu and then click the corresponding << button fill in the MAC address automatically. Click the Clear button to remove any entered MAC address.

The screenshot shows the D-Link DIR-505 Router Web Interface. The top navigation bar includes 'D-Link', 'DIR-505 // Router', and tabs for 'SETUP', 'ADVANCED', 'MAINTENANCE', 'STATUS', and 'HELP'. The 'ADVANCED' tab is selected, and the 'MAC ADDRESS FILTER' option is highlighted in the left sidebar. The main content area is titled 'MAC ADDRESS FILTER' and contains the following text: 'The MAC (Media Access Controller) Address filter option is used to control network access based on the MAC Address of the network adapter. A MAC address is a unique ID assigned by the manufacturer of the network adapter. This feature can be configured to ALLOW or DENY network/Internet access.' Below this text are 'Save Settings' and 'Don't Save Settings' buttons. The 'WIRELESS ACCESS SETTINGS' section is expanded, showing a dropdown menu for 'Configure MAC Filtering below:' set to 'Turn MAC Filtering OFF'. Below this is a table with two columns: 'MAC Address' and 'Wireless Client List'. The table contains eight rows, each with a '00:00:00:00:00:00' MAC address, a '<<' button, a 'MAC Address' dropdown menu, and a 'Clear' button. The footer of the interface includes 'WIRELESS' and 'Copyright © 2012 D-Link Corporation/D-Link Systems, Inc.'

Website Filters

Website Filters are used to allow you to set up a list of websites to either allow or block access to. After making your changes, click the **Save Settings** button.

Website Filtering Rules: Configure how website filtering works by using the dropdown box to select an option:

DENY computers access to ONLY these sites: When this option is selected, all PCs and devices on your network will be blocked access to the websites specified All other websites will be allowed access.

ALLOW computers access to ONLY these sites: When this option is selected, all PCs and devices on your network will only be allowed to access to the websites specified. All other websites will be blocked.

Website URL/Domain: Enter the websites you want to block or allow in the text boxes. Any website address that contains the text entered will be blocked.

The screenshot shows the D-Link DIR-505 Router web interface. The top navigation bar includes the D-Link logo and tabs for SETUP, ADVANCED, MAINTENANCE, STATUS, and HELP. The left sidebar lists various configuration sections: VIRTUAL SERVER, APPLICATION RULES, MAC ADDRESS FILTER, WEBSITE FILTER (highlighted), FIREWALL SETTINGS, ADVANCED WIRELESS, WI-FI PROTECTED SETUP, UPNP SETTINGS, GUEST ZONE, and DMZ. The main content area is titled "WEBSITE FILTER" and contains the following text: "The Website Filter option allows you to set up a list of Web sites you would like to allow or deny through your network. To use this feature, you must also select the 'Apply Web Filter' checkbox in the Access Control section." Below this text are two buttons: "Save Settings" and "Don't Save Settings". A section titled "8 -- WEBSITE FILTERING RULES" contains the instruction "Configure Website Filter below:" followed by a dropdown menu set to "ALLOW computers access to ONLY these sites" and a "Clear the list below..." button. Below the dropdown is a table with the header "Website URL/Domain" and four rows of input fields. The right sidebar contains "Helpful Hints..." with instructions: "Create a list of Web Sites to which you would like to deny or allow through the network." and a "More..." link. The footer of the interface includes the "WIRELESS" section and the copyright notice: "Copyright © 2012 D-Link Corporation/D-Link Systems, Inc."

Firewall Settings

Enabling the SPI firewall and anti-spoof checking helps protect against attacks over the Internet. In some cases, you may want to disable them if you are having problems getting certain applications to work. After making your changes, click the **Save Settings** button.

Enable SPI: SPI (Stateful Packet Inspection, also known as dynamic packet filtering) helps to prevent cyber attacks by tracking more state per session. It validates that the traffic passing through the session conforms to the protocol.

Anti-Spoof Check: Enable this feature to protect your network from certain kinds of “spoofing” attacks.

The screenshot shows the D-Link DIR-505 Router's web interface. The top navigation bar includes 'D-Link', 'DIR-505 Router', and tabs for 'SETUP', 'ADVANCED', 'MAINTENANCE', 'STATUS', and 'HELP'. The left sidebar lists various settings categories, with 'FIREWALL SETTINGS' selected. The main content area is divided into three sections:

- FIREWALL SETTINGS:** Contains the text "The Firewall Settings allow you to set a single computer on your network outside of the router." and two buttons: "Save Settings" and "Don't Save Settings".
- FIREWALL SETTINGS:** A sub-section containing the checkbox "Enable SPI :
- ANTI-SPOOF CHECKING:** A sub-section containing the checkbox "Enable anti-spoof checking :

At the bottom of the page, there is a 'WIRELESS' section header and a copyright notice: "Copyright © 2012 D-Link Corporation/D-Link Systems, Inc."

Advanced Wireless

This screen allows you to set various advanced wireless settings of your DIR-505. Unless you are experiencing specific problems, it is recommended that you leave these settings at their default values. After making your changes, click the **Save Settings** button.

Transmit Power: Use the dropdown box to set the transmit power of the antennas.

WMM Enable: WMM is Quality of Service(QoS) for your wireless network. This will improve the quality of video and voice applications for your wireless clients.

Short GI: Check this box to reduce the guard interval time therefore increasing the data capacity. However, this may create a less reliable connection and may create higher data loss.

IGMP Snooping: Tick this checkbox to enable this feature.

WLAN Partition: This enables 802.11d operation. 802.11d is a wireless specification developed to allow implementation of wireless networks in countries that cannot use the 802.11 standard. This feature should only be enabled if you are in a country that requires it.

HT 20/40 Coexistence: Tick this checkbox to enable this feature.

D-Link

DIR-505 Router

SETUP ADVANCED MAINTENANCE STATUS HELP

ADVANCED WIRELESS

If you are not familiar with these Advanced Wireless settings, please read the help section before attempting to modify these settings.

Save Settings Don't Save Settings

ADVANCED WIRELESS SETTINGS

Transmit Power : 100%

WMM Enable :

Short GI :

IGMP Snooping :

WLAN Partition :

HT20/40 Coexistence : Enable Disable

Helpful Hints...

Advanced Wireless: It is recommended that you leave these options at their default values. Adjusting them could negatively impact the performance of your wireless network. The options on this page should be changed by advanced users or if you are instructed to by one of our support personnel, as they can negatively affect the performance of your Access Point if configured improperly.

Transmit Power: You can lower the output power of the DIR-505 by selecting lower percentage Transmit Power values from the drop down. Your choices are: 100%, 75%, 50%, and 25%.

WIRELESS

Copyright © 2012 D-Link Corporation/D-Link Systems, Inc.

Wi-Fi Protected Setup (WPS)

Wi-Fi Protected Setup (WPS) System is a simplified way to set up the basic settings of the DIR-505. It can also be used to automatically create a secure wireless connection to a wireless client. After making your changes, click the **Save Settings** button.

Enable: Check this box to enable the WPS functions of the DIR-505.

Disable WPS PIN Method: Disabling this will disable the WPS PIN method of connection and configuration. If you want to reconfigure the router using the WPS PIN method, click on the **Reset to Unconfigured** button. You will still be able to add wireless clients through WPS.

PIN Settings: Shows the router's current PIN. You can reset it to the default value by clicking on the **Reset PIN to Default** button, or you can create a new PIN number by clicking on the **Generate New PIN** button.

Add Wireless Station: Here, you can click on the **Add Wireless Device With WPS** button to go through a wizard that helps you connect other devices through WPS.

The screenshot displays the D-Link DIR-505 Router Web Interface. The top navigation bar includes the D-Link logo and tabs for SETUP, ADVANCED, MAINTENANCE, STATUS, and HELP. The left sidebar lists various configuration categories: VIRTUAL SERVER, APPLICATION RULES, MAC ADDRESS FILTER, WEBSITE FILTER, FIREWALL SETTINGS, ADVANCED WIRELESS, WI-FI PROTECTED SETUP, UPnP SETTINGS, GUEST ZONE, and DMZ. The main content area is titled "WI-FI PROTECTED SETUP" and contains the following sections:

- WI-FI PROTECTED SETUP:** Includes explanatory text about the WPS process and two buttons: "Save Settings" and "Don't Save Settings".
- WI-FI PROTECTED SETUP:** A configuration section with "Enable" and "Disable WPS-PIN Method" both checked, and a "Reset to Unconfigured" button.
- PIN SETTINGS:** Shows the "Current PIN" as 57893402, with "Reset PIN to Default" and "Generate New PIN" buttons.
- ADD WIRELESS STATION:** Features an "Add Wireless Device With WPS" button.

On the right side, there are "Helpful Hints..." and "Click Add Wireless Device Wizard to use Wi-Fi Protected Setup to add wireless devices to the wireless network." sections.

At the bottom of the interface, the word "WIRELESS" is displayed, and a copyright notice reads: "Copyright © 2012 D-Link Corporation/D-Link Systems, Inc."

UPnP Settings

This page allows you to enable UPnP, which can help provide compatibility with some networking equipment, software, and peripherals. After making your changes, click the **Save Settings** button.

Enable UPnP: To use the Universal Plug and Play (UPnP™) feature tick the **Enabled** checkbox.

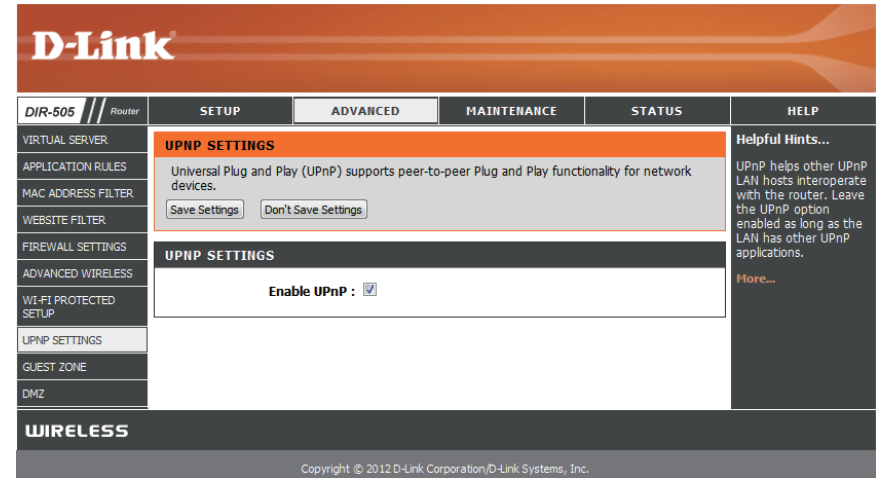

The screenshot shows the D-Link DIR-505 Router's Advanced Settings page. The 'UPnP SETTINGS' section is highlighted in orange. The 'Enable UPnP' checkbox is checked. The page also includes a 'Helpful Hints...' section on the right and a 'WIRELESS' section at the bottom.

DIR-505 Router	SETUP	ADVANCED	MAINTENANCE	STATUS	HELP
VIRTUAL SERVER	UPnP SETTINGS Universal Plug and Play (UPnP) supports peer-to-peer Plug and Play functionality for network devices. <input type="button" value="Save Settings"/> <input type="button" value="Don't Save Settings"/>				Helpful Hints... UPnP helps other UPnP LAN hosts interoperate with the router. Leave the UPnP option enabled as long as the LAN has other UPnP applications. More...
APPLICATION RULES	UPnP SETTINGS Enable UPnP : <input checked="" type="checkbox"/>				
MAC ADDRESS FILTER					
WEBSITE FILTER					
FIREWALL SETTINGS					
ADVANCED WIRELESS					
WI-FI PROTECTED SETUP					
UPnP SETTINGS					
GUEST ZONE					
DMZ					
WIRELESS					
Copyright © 2012 D-Link Corporation/D-Link Systems, Inc.					

Guest Zone

The Guest Zone feature will allow you to create a separate wireless network that can be used by guests to access the Internet. These zones will be separate from your main wireless network, allowing you to share Internet access without allowing them to connect to your own devices. After making your changes, click the **Save Settings** button.

Enable Guest Zone: Tick this checkbox to enable the Guest Zone feature.

Add New Schedule: Select when the Guest Zone will be active. The schedule may be set to **Always**, which will allow the Guest Zone to be on at all times. You can select a schedule you created, or you can click the **Add New Schedule** button to create a schedule.

Wireless Network Name: Enter a wireless network name (SSID) for your guest zone. It should be different than the network name of your main wireless network.

Enable Routing Between Zones: Check to allow network connectivity between the Guest Zone and your main network.

Security Mode: Here, you can select between **None**, **WEP**, **WPA-Personal**, and **WPA-Enterprise**. Refer to "Wireless Settings" on page 38 for information on how to configure the different security modes.

The screenshot shows the D-Link DIR-505 Router web interface. The top navigation bar includes 'D-Link', 'DIR-505 Router', and tabs for 'SETUP', 'ADVANCED', 'MAINTENANCE', 'STATUS', and 'HELP'. The 'ADVANCED' tab is selected, and the 'GUEST ZONE' sub-tab is active. The main content area is titled 'GUEST ZONE' and contains the following configuration options:

- Enable Guest Zone:** A checked checkbox with a dropdown menu set to 'Always' and an 'Add New Schedule' button.
- Wireless Band:** A dropdown menu set to '2.4GHz Band'.
- Wireless Network Name:** A text input field containing 'dlink_guest' with a note '(Also called the SSID)'.
- Enable Routing Between Zones:** An unchecked checkbox.
- Security Mode:** A dropdown menu set to 'None'.

Below the main configuration area, there is a 'WIRELESS' section. On the right side, there is a 'Helpful Hints...' section with text explaining the purpose of the Guest Zone and a 'More...' link. At the bottom of the page, there is a copyright notice: 'Copyright © 2012 D-Link Corporation/D-Link Systems, Inc.'

DMZ

Enabling DMZ allows you to set a single PC or network device to “be exposed” outside of the router and have unrestricted Internet access. It is not recommended for normal use, and should only be used if you need this feature for a specific reason. After making your changes, click the **Save Settings** button.

Enable DMZ: Check the box to enable DMZ.

DMZ IP Address: Enter the IP address of the device on your network you want to place in the DMZ. You can use the dropdown box to select a device, then click the << button to automatically fill in the IP address of that device.

The screenshot shows the D-Link DIR-505 Router web interface. The top navigation bar includes 'D-Link', 'DIR-505 Router', and tabs for 'SETUP', 'ADVANCED', 'MAINTENANCE', 'STATUS', and 'HELP'. The left sidebar lists various settings categories, with 'DMZ' selected. The main content area is titled 'DMZ SETTINGS' and contains the following text:

The DMZ (Demilitarized Zone) option lets you set a single computer on your network outside of the router. If you have a computer that cannot run Internet applications successfully from behind the router, then you can place the computer into the DMZ for unrestricted Internet access.

Note: Putting a computer in the DMZ may expose that computer to a variety of security risks. Use of this option is only recommended as a last resort.

Buttons for 'Save Settings' and 'Don't Save Settings' are visible.

The 'DMZ HOST' section includes:

- Enable DMZ :
- DMZ IP Address : 0.0.0.0 << Computer Name >>

A 'Helpful Hints...' section on the right provides additional information: 'Enable the DMZ option only as a last resort. If you are having trouble using an application from a computer behind the router, first try opening ports associated with the application in the Virtual Server sections. More...'

The footer of the interface includes the 'WIRELESS' section and the copyright notice: 'Copyright © 2012 D-Link Corporation/D-Link Systems, Inc.'

Maintenance Admin

This page will allow you to change the password for the administrator account for configuring the settings of the DIR-505. You can also turn on graphical authentication(CAPTCHA) on this page. After making your changes, click the **Save Settings** button.

Password: Enter a new password for the Administrator Login Name. The administrator can make changes to the settings.

Verify Password: Enter the same password that you entered in the previous textbox in order to confirm its accuracy.

Enable Graphical Authentication: Check to enable Graphical Authentication, or CAPTCHAs when logging in to the web UI of the DIR-505. This provides an extra layer of security by requiring you to enter a code that is displayed on-screen.

Enable HTTPS Server: Check to enable HTTPS when connecting to the router for configuration. When enabled, you will need to enter **https://** to connect to the DIR-505. For example: **https://dlinkrouter**

Enable Remote Management: Remote management allows the DIR-505 to be configured over the Internet through a web browser. A username/password is still required to access the configuration interface.

Remote Admin Port: This is the port that will be used to access the DIR-505 configuration interface when using remote management. You will need to add this port number after the IP address.

Example: **http://x.x.x.x:8080** where x.x.x.x is the IP address of the DIR-505 and 8080 is the remote admin port.

The screenshot displays the D-Link web interface for the Maintenance Admin page. The top navigation bar includes 'D-Link', 'DIR-505 Router', and tabs for 'SETUP', 'ADVANCED', 'MAINTENANCE', 'STATUS', and 'HELP'. The 'MAINTENANCE' tab is active, showing the 'ADMINISTRATOR SETTINGS' section. This section contains a text box for the 'ADMINISTRATOR SETTINGS' with a warning about the 'admin' account, and two password input fields labeled 'Password' and 'Verify Password'. Below this is the 'ADMINISTRATION' section with three checkboxes: 'Enable Graphical Authentication', 'Enable HTTPS Server', and 'Enable Remote Management', and a 'Remote Admin Port' field set to 8080. A sidebar on the right provides 'Helpful Hints...' regarding password security and remote management. The footer includes the 'WIRELESS' logo and copyright information for 2012 D-Link Corporation.

Time

The Time page allows you to configure, update, and maintain the correct time on the internal system clock. From this section you can set the time zone that you are in. Daylight Saving can also be configured to automatically adjust the time when needed. After making your changes, click the **Save Settings** button.

Time Zone: Select the Time Zone from the drop-down menu.

Enable Daylight Saving: To select Daylight Saving time manually, click the **Enable Daylight Saving** check box. Next use the drop-down menu to select a **Daylight Saving Offset** and then enter a start date and an end date for daylight saving time.

Enable NTP Server: NTP is short for Network Time Protocol. NTP synchronizes computer clock times in a network of computers. Check this box to use a NTP server. This will only connect to a server on the Internet, not a local server.

NTP Server Used: Enter the NTP server or select one from the drop-down menu.

Date and Time: To manually input the time, enter the values in these fields for the Year, Month, Day, Hour, Minute, and Second and then click **Save Settings**. You can also click the **Copy Your Computer's Time Settings** button at the bottom of the screen.

The screenshot shows the D-Link DIR-505 Router configuration interface. The main navigation bar includes ADMIN, SETUP, ADVANCED, MAINTENANCE, STATUS, and HELP. The left sidebar lists various configuration categories: ADMIN, TIME, SYSTEM, FIRMWARE, DYNAMIC DNS, SYSTEM CHECK, and SCHEDULES. The main content area is titled 'TIME' and contains the following sections:

- TIME:** A descriptive paragraph about the Time Configuration option and two buttons: 'Save Settings' and 'Don't Save Settings'.
- TIME CONFIGURATION:**
 - Current Router Time: Jan/01/2011 16:18:28
 - Time Zone: (GMT+08:00) Taipei
 - Enable Daylight Saving:
 - Daylight Saving Dates:

DST start	Month	Week	Day of Week	Time
Mar	3rd	Sun	1 am	
DST End	Nov	2nd	Sun	1 am
- AUTOMATIC TIME CONFIGURATION:**
 - Enable NTP Server:
 - NTP Server Used: << Select NTP Server >>
- SET THE DATE AND TIME MANUALLY:**
 - Date And Time: Year (2011), Month (Jan), Day (01), Hour (00), Minute (00), Second (00)
 - Copy Your Computer's Time Settings

The footer of the page reads: Copyright © 2012 D-Link Corporation/D-Link Systems, Inc.

System

This page allows you to save and restore your configuration, reset and reboot the DIR-505, and remove any added language packs.

Save Settings To Local Hard Drive: Clicking the **Save** button will allow you to save the current repeater configuration settings to a file on the hard disk of the computer you are using. You will then see a file dialog where you can select a location and file name for the settings.

Load Settings From Local Hard Drive: Use this option to load previously saved configuration settings. Click **Browse** to find a previously saved configuration file. Then, click the **Upload Settings** button to transfer those settings to the DIR-505.

Restore to Factory Default Settings: This option will restore all configuration settings back to the factory default settings. Any settings that have not been saved will be lost, including any rules that you have created. If you want to save your current configuration settings, use the **Save** button above.

Note: Restoring the factory default settings will not reset the Wi-Fi Protected Status to Not Configured.

Reboot the Device: Click the **Reboot** button to reboot the repeater.

Remove Language Pack: If you have previously installed a Language Pack, you can remove it by clicking the Remove button.

Firmware

You can upgrade the firmware of the DIR-505 here. Make sure the firmware you want to use is on the local hard drive of the computer. Click on **Browse** to locate the firmware file to be used for the update. Please check the D-Link support website for firmware updates at <http://support.dlink.com>. You can download firmware upgrades to your hard drive from this site.

Firmware Upgrade: Click on **Check Now** to find out if there is an updated firmware; if so, download the new firmware to your hard drive.

After you have downloaded the new firmware, click **Browse** to locate the firmware update on your hard drive. Click **Upload** to complete the firmware upgrade. Do not disconnect from the DIR-505 or power your computer or DIR-505 off during the upgrade process.

You can change the language of the web UI by uploading available language packs.

Browse: Download a language pack from the D-Link website. After you have downloaded the new language pack, click **Browse** to locate the language pack file on your hard drive. Click **Upload** to complete the language pack upgrade.

The screenshot shows the D-Link DIR-505 Router web interface. The top navigation bar includes 'DIR-505 // Router', 'SETUP', 'ADVANCED', 'MAINTENANCE', 'STATUS', and 'HELP'. The 'MAINTENANCE' tab is selected, and the 'FIRMWARE' sub-tab is active. The main content area is titled 'FIRMWARE' and contains the following text:

There may be new firmware for your DIR-505 to improve functionality and performance. [Click here to check for an upgrade on our support site.](#)

After you have download the new firmware file from our support site, click the Browse button below to find the firmware file on your local hard drive. Click the Upload button to update the firmware on the DIR-505.

Do not update firmware through wireless network!!

FIRMWARE AND LANGUAGE PACK INFORMATION

Current Firmware Version : 1.05 Date : 2012/9/19
 Current Language Pack Version : No Language pack

Check Online Now for Latest Firmware and Language pack Version :

FIRMWARE UPGRADE

Note: Some firmware upgrades reset the configuration options to the factory defaults. Before performing an upgrade, be sure to save the current configuration from the Maintenance - System screen

To upgrade the firmware, your PC must have a wired connection to the access point. Enter the name of the firmware upgrade file, and click on the Upload button.

Upload :

LANGUAGE PACK UPGRADE

Upload :

The bottom of the page features a 'WIRELESS' section header.

Dynamic DNS

The DDNS feature allows you to host a server (Web, FTP, Game Server, etc...) behind your DIR-505 using a domain name that you have purchased (www.whateveryournameis.com) with your dynamically assigned IP address. Most broadband Internet Service Providers assign dynamic (changing) IP addresses. Using a DDNS service provider, your friends can enter in your domain name to connect to your server no matter what your IP address is. After making your changes, click the **Save Settings** button.

Enable Dynamic DNS: Tick the checkbox to enable DDNS.

Server Address: Enter the DDNS server address, or select your DDNS service from the drop-down menu and click the << button to automatically fill in the address for the DDNS service.

Host Name: Enter the Host Name that you registered with your DDNS service provider.

Username or Key: Enter the Username or key for your DDNS account.

Password or Key: Enter the Password or key for your DDNS account.

Timeout: Enter a timeout time (in hours).

Status: This displays the DDNS server update status.

The screenshot shows the D-Link DIR-505 Router's Dynamic DNS configuration page. The page is titled "D-Link" and "DIR-505 Router". The navigation menu includes SETUP, ADVANCED, MAINTENANCE, STATUS, and HELP. The "DYNAMIC DNS" section is highlighted in orange. Below the header, there is a "Helpful Hints..." section with a "More..." link. The main content area contains the following information:

The DDNS feature allows you to host a server (Web, FTP, Game Server, etc...) using a domain name that you have purchased (www.whateveryournameis.com) with your dynamically assigned IP address. Most broadband Internet Service Providers assign dynamic (changing) IP addresses. Using a DDNS service provider, your friends can enter your host name to connect to your game server no matter what your IP address is.

Sign up for D-Link's Free DDNS service at www.dlinkddns.com

Buttons: Save Settings, Don't Save Settings

DYNAMIC DNS

Enable Dynamic DNS:

Server Address: << Select Dynamic DNS Server

Host Name:

Username or Key:

Password or Key:

Verify Password or Key:

Timeout: 576 (hours)

Status: Disconnected

At the bottom of the page, there is a "WIRELESS" section and a copyright notice: Copyright © 2012 D-Link Corporation/D-Link Systems, Inc.

System Check

This page allows you to run a ping test to check your Internet connectivity.

Ping Test: The Ping Test is used to send ping packets to test if your DIR-505 is connected to the Internet. Enter the IP address that you wish to ping and click the **Ping** button.

Ping Results: The results of your ping attempts will be displayed here.

The screenshot displays the D-Link DIR-505 Router web interface. At the top, the D-Link logo is visible. Below it, a navigation bar includes tabs for SETUP, ADVANCED, MAINTENANCE, STATUS, and HELP. The MAINTENANCE tab is selected, and the PING TEST option is highlighted in orange. The main content area is divided into three sections: a description of the Ping Test, a form to enter the Host Name or IP Address with a Ping button, and a section for PING RESULT. A sidebar on the right contains Helpful Hints and a More... link. The footer includes the WIRELESS logo and copyright information for 2012 D-Link Corporation.

DIR-505 // Router	SETUP	ADVANCED	MAINTENANCE	STATUS	HELP
ADMIN	PING TEST				Helpful Hints... "Ping" checks whether a computer on the Internet is running and responding. Enter either the IP address of the target computer or enter its fully qualified domain name. More...
TIME	Ping Test sends "ping" packets to test a computer on the Internet.				
SYSTEM	PING TEST				
FIRMWARE	Host Name or IP Address: <input type="text"/> <input type="button" value="Ping"/>				
DYNAMIC DNS	PING RESULT				
SYSTEM CHECK					
SCHEDULES					

WIRELESS

Copyright © 2012 D-Link Corporation/D-Link Systems, Inc.

Schedules

You can create schedules for use with some of the features of the DIR-505, which will allow those features to be active during certain times of the day or week.

Name: Enter a name for your new schedule.

Days: Select a day, a range of days, or All Week to include every day of the week.

Time format: Check **All Day - 24hrs** or enter a start and end times for your schedule.

Save: After entering the details of your schedule, click the **Save** button to save your changes.

Schedule Rules List: The list of created schedules will be listed here. Click the **Edit** icon to make changes or click the **Delete** icon to remove the schedule.

The screenshot shows the D-Link DIR-505 Router web interface. The top navigation bar includes 'D-Link', 'DIR-505 Router', and tabs for 'SETUP', 'ADVANCED', 'MAINTENANCE', 'STATUS', and 'HELP'. The left sidebar lists various system settings: ADMIN, TIME, SYSTEM, FIRMWARE, DYNAMIC DNS, SYSTEM CHECK, and SCHEDULES (which is currently selected).

The main content area is titled 'SCHEDULES' and contains the following sections:

- SCHEDULES:** A header section with a description: "The Schedule configuration option is used to manage schedule rules for various firewall and parental control features."
- ADD SCHEDULE RULE:** A form for creating a new schedule. It includes:
 - Name:** A text input field.
 - Day(s):** Radio buttons for 'All Week' (selected) and 'Select Day(s)'. Under 'Select Day(s)', there are checkboxes for Sun, Mon, Tue, Wed, Thu, Fri, and Sat.
 - All Day - 24 hrs:** A checkbox.
 - Time format:** A dropdown menu set to '24-hour'.
 - Start Time:** Two input fields for hours and minutes, with an AM/PM dropdown.
 - End Time:** Two input fields for hours and minutes, with an AM/PM dropdown.
 - Buttons:** 'Save' and 'Clear' buttons.
- SCHEDULE RULES LIST:** A table with columns for 'Name', 'Day(s)', and 'Time Frame'. The table is currently empty.

The right sidebar, titled 'Helpful Hints...', provides instructions:

- Schedules are used with a number of other features to define when those features are in effect.
- Give each schedule a name that is meaningful to you. For example, a schedule for Monday through Friday from 3:00pm to 9:00pm, might be called "After School".
- Click **Save** to add a completed schedule to the list below.
- Click the **Edit** icon to change an existing schedule.
- Click the **Delete** icon to permanently delete a schedule.
- More...**

The footer of the page includes the 'WIRELESS' logo and the copyright notice: "Copyright © 2012 D-Link Corporation/D-Link Systems, Inc."

Status

Device Info

This page displays the current information for the DIR-505. It will display the LAN and wireless LAN information.

General: Displays the time and firmware version.

WAN Displays information about the connection to your modem or Internet connection.

LAN: Displays the MAC address and the private (local) IP settings for the access point.

Wireless LAN: Displays the wireless MAC address and your wireless settings such as SSID and Channel.

LAN Computers: Displays information about the devices on your local network.

The screenshot shows the D-Link DIR-505 Router Status page. The page is divided into several sections:

- Header:** D-Link logo and navigation tabs: SETUP, ADVANCED, MAINTENANCE, STATUS (selected), HELP.
- Left Sidebar:** Navigation menu with options: DIR-505 Router, DEVICE INFO (selected), LOGS, STATISTICS, INTERNET SESSIONS, WIRELESS.
- Main Content Area:**
 - DEVICE INFORMATION:** All of your wireless and network connection details are displayed on this page. The firmware version is also displayed here.
 - GENERAL:**
 - Time : Jan/01/2011 03:43:50
 - System Up Time : 0 Day, 03:44:06
 - Firmware Version : 1.00, Wed, 29 Feb 2012
 - WAN:**
 - Connection Type : DHCP client
 - Cable Status : Disconnected
 - Network Status : Disconnected
 - Buttons: DHCP Renew, DHCP Release
 - Connection Up Time : N/A
 - MAC Address : 00:18:e7:95:6d:c9
 - IP Address : 0.0.0.0
 - Subnet Mask : 0.0.0.0
 - Default Gateway : 0.0.0.0
 - Primary DNS Server : 0.0.0.0
 - Secondary DNS Server : 0.0.0.0
 - LAN:**
 - MAC Address : 00:18:e7:95:6d:c8
 - IP Address : 192.168.0.1
 - Subnet Mask : 255.255.255.0
 - DHCP Server : Enabled
 - WIRELESS LAN:**
 - Wireless Radio : Enable
 - Wireless Mode : Mixed 802.11n, 802.11g and 802.11b
 - Channel Width : Auto 20/40 MHz
 - Channel : 1
 - Wi-Fi Protected Setup : Enable / Configured
 - SSID List:**

Network Name (SSID)	Guest	MAC Address	Security Mode
MobileCompanion-Claire	No	00:18:e7:95:6d:c8	WPA/WPA2 - Personal
 - LAN COMPUTERS:** (Section header, content not visible)
- Right Sidebar:** Helpful Hints... All of your WAN and LAN connection details are displayed here. More...

Logs

The DIR-505 keeps a running log of events and activities occurring on the DIR-505. If the DIR-505 is rebooted, the logs are automatically cleared.

Log Options: There are several types of logs that can be viewed: **System Activity, Debug Information, Attacks, Dropped Packets** and **Notice**.

First Page: This button directs you to the first page of the log.

Last Page: This button directs you to the last page of the log.

Previous: This button directs you to the previous page of the log.

Next: This button directs you to the next page of the log.

Clear: This button clears all current log content.

Save Log: This button opens dialog where you can save the current log to your hard drive.

Refresh: This button refreshes the log.

D-Link

DIR-505 Router

SETUP ADVANCED MAINTENANCE STATUS HELP

DEVICE INFO LOGS STATISTICS INTERNET SESSIONS WIRELESS

LOGS

Use this option to view the device logs. You can define what types of events you want to view and the event levels to view.

LOG OPTIONS

Log Type : System Activity Debug Information Attacks
 Dropped Packets Notice

Apply Log Settings Now

LOG DETAILS

First Page Last Page Previous Next Save Log

Refresh Clear

1/4

Time	Message
Jan 1 16:20:15	ath0: STA 28:e0:2c:dc:0a:be WPA: group key handshake completed (RSN)
Jan 1 16:20:15	ath0: STA 00:24:2c:2b:a7:dc WPA: group key handshake completed (RSN)
Jan 1 16:17:59	UDHCPD Inform: add_lease 192.168.0.101
Jan 1 16:10:15	ath0: STA 28:e0:2c:dc:0a:be WPA: group key handshake completed (RSN)
Jan 1 16:10:15	ath0: STA 00:24:2c:2b:a7:dc WPA: group key handshake completed (RSN)
Jan 1 16:10:05	UDHCPD Inform: add_lease 192.168.0.101
Jan 1 16:09:59	UDHCPD sending OFFER of 192.168.0.101
Jan 1 16:09:59	UDHCPD sendOffer : device_lan_ip=192.168.0.1 , device_lan_subnet_mask=255.255.255.0
Jan 1 16:09:42	UDHCPD sending OFFER of 192.168.0.101
Jan 1 16:09:42	UDHCPD sendOffer : device_lan_ip=192.168.0.1 , device_lan_subnet_mask=255.255.255.0

WIRELESS

Copyright © 2012 D-Link Corporation, D-Link Systems, Inc.

Statistics

The DIR-505 keeps statistics of the traffic that passes through it. You can view the amount of packets that pass through the LAN and wireless portions of the network. Click the **Refresh Statistics** button to update the information, or click the **Clear Statistics** button to reset all statistics. The traffic counter will reset if the DIR-505 is rebooted.

The screenshot shows the D-Link DIR-505 web interface. The top navigation bar includes 'DIR-505 Router', 'SETUP', 'ADVANCED', 'MAINTENANCE', 'STATUS', and 'HELP'. The left sidebar lists 'DEVICE INFO', 'LOGS', 'STATISTICS', 'INTERNET SESSIONS', and 'WIRELESS'. The main content area is titled 'TRAFFIC STATISTICS' and contains the following information:

Traffic Statistics display Receive and Transmit packets passing through your router.

[Refresh Statistics](#) [Clear Statistics](#)

LAN STATISTICS

Sent : 36024	Received : 10247
TX Packets Dropped : 0	RX Packets Dropped : 0
Collisions : 0	Errors : 0

WAN STATISTICS

Sent : 0	Received : 0
TX Packets Dropped : 0	RX Packets Dropped : 0
Collisions : 0	Errors : 0

WIRELESS STATISTICS

Sent : 23499	Received : 10250
TX Packets Dropped : 17703	RX Packets Dropped : 0
Collisions : 0	Errors : 0

Helpful Hints... This is a summary of the number of packets that have passed between the WAN and the LAN since the router was last initialized. [More...](#)

WIRELESS

Copyright © 2012 D-Link Corporation/D-Link Systems, Inc.

Internet Sessions

The Internet Sessions page displays full details of active Internet sessions through your router. An Internet session is a conversation between a program or application on a LAN-side computer and a program or application on a WAN-side computer.

The screenshot shows the D-Link DIR-505 Router Web Interface. The top navigation bar includes the D-Link logo and a menu with options: DIR-505 // Router, SETUP, ADVANCED, MAINTENANCE, STATUS, and HELP. The main content area is divided into a left sidebar with links for DEVICE INFO, LOGS, STATISTICS, INTERNET SESSIONS (highlighted), and WIRELESS. The central panel displays the 'INTERNET SESSIONS' page, which includes a sub-header, a descriptive text box stating 'This page displays the full details of active internet sessions to your router.', and a table with columns: Local, NAT, Internet, Protocol, State, Dir, and Time-Out. A right sidebar contains 'Helpful Hints...' text and a 'More...' link. The footer of the interface shows 'WIRELESS' and 'Copyright © 2012 D-Link Corporation/D-Link Systems, Inc.'

Wireless

The wireless client table displays a list of current connected wireless clients. This table also displays the connection time and MAC address of the connected wireless clients.

The screenshot shows the D-Link DIR-505 Router Web Interface. The top navigation bar includes the D-Link logo and tabs for SETUP, ADVANCED, MAINTENANCE, STATUS, and HELP. The left sidebar contains menu items: DEVICE INFO, LOGS, STATISTICS, INTERNET SESSIONS, and WIRELESS. The main content area is titled "WIRELESS" and contains a message: "Use this option to view the wireless clients that are connected to your wireless router." Below this message, it states "NUMBER OF WIRELESS CLIENTS : 2". A table displays the details of the two connected wireless clients:

MAC Address	IP Address	Mode	Rate (Mbps)	Signal (%)
28:e0:2c:dc:0a:be	192.168.0.100	802.11n (2.4GHz)	25M	100
00:24:2c:2b:a7:dc	192.168.0.101	802.11g	52M	100

On the right side of the interface, there is a "Helpful Hints..." section with the text: "This is a list of all wireless clients that are currently connected to your wireless router." and a "More..." link. The footer of the interface displays "WIRELESS" and the copyright notice: "Copyright © 2012 D-Link Corporation/D-Link Systems, Inc."

Help

This screen gives you more information about the various parts of the configuration interface. Click on a link to learn more about that topic.

D-Link

DIR-505 Router

MENU	SETUP	ADVANCED	MAINTENANCE	STATUS	HELP
MENU	SUPPORT MENU				Helpful Hints...
SETUP	<ul style="list-style-type: none"> Setup Advanced Maintenance Status 				<p>Click on the links for more informations of each section in the GUI.</p>
ADVANCED	SETUP HELP				
MAINTENANCE	<ul style="list-style-type: none"> Internet Connection Internet Settings Wireless Settings Network Settings 				
STATUS	ADVANCED HELP				
	<ul style="list-style-type: none"> Virtual Server Application Rules MAC Address Filter Website Filter Firewall Settings Advanced Wireless Wi-Fi Protected Setup UPnP Settings Guest Zone DMZ 				
	MAINTENANCE HELP				
	<ul style="list-style-type: none"> Admin Time System Firmware Dynamic DNS System Check Schedules 				
	STATUS HELP				
	<ul style="list-style-type: none"> Device Info Logs Statistics Internet Sessions Wireless 				

WIRELESS

Copyright © 2012 D-Link Corporation/D-Link Systems, Inc.

Access Point Mode

This section describes the configuration interface for Access Point mode. Make sure that the mode selector switch is in the Router/AP position on your DIR-505.

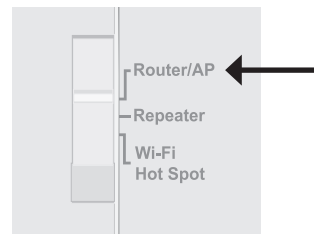

If this is your first time configuring the DIR-505, open your web browser and type **http://dlinkrouter** in the address bar. You will automatically be directed to the **Wizard Setup Screen**. For more information, refer to “Initial Setup Wizard (Router/AP Mode)” on page 18.

If the Setup Wizard does not appear, type **http://dlinkrouter** in the address bar.

Otherwise, the main configuration screen will appear. If the DIR-505 is in Router mode, you will need to click on **Manual Internet Connection Setup**, select **Access Point** for your **Operation Mode**, then click the **Save Settings** button to switch to Access Point mode.

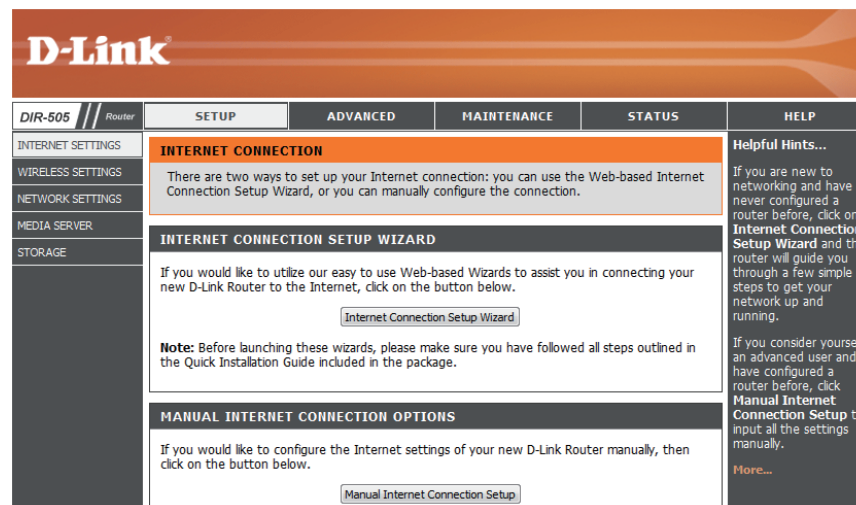

Setup

Setup Wizard

If you want to configure the Access Point Mode of the DIR-505 using a wizard, click **Launch Wireless Setup Wizard**. For more details on the setup wizard, refer to “Initial Setup Wizard (Router/AP Mode)” on page 18.

To configure your DIR-505 manually, click **Wireless Setup** to configure your wireless connection or click **LAN Setup** to configure the LAN options. Each section is detailed in the following pages.

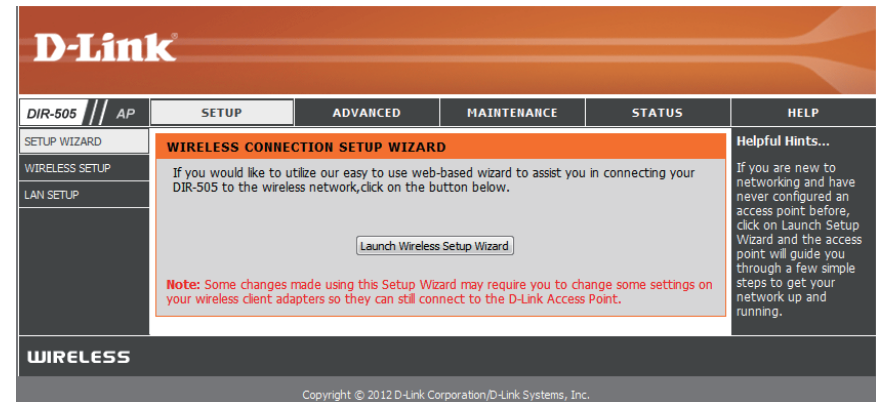

The screenshot displays the D-Link web interface for the DIR-505 in AP mode. The top navigation bar includes the D-Link logo and tabs for SETUP, ADVANCED, MAINTENANCE, STATUS, and HELP. The left sidebar shows a menu with options for SETUP WIZARD, WIRELESS SETUP, and LAN SETUP. The main content area is titled "WIRELESS CONNECTION SETUP WIZARD" and contains the following text:

If you would like to utilize our easy to use web-based wizard to assist you in connecting your DIR-505 to the wireless network, click on the button below.

[Launch Wireless Setup Wizard](#)

Note: Some changes made using this Setup Wizard may require you to change some settings on your wireless client adapters so they can still connect to the D-Link Access Point.

Helpful Hints... If you are new to networking and have never configured an access point before, click on Launch Setup Wizard and the access point will guide you through a few simple steps to get your network up and running.

At the bottom of the page, there is a "WIRELESS" section header and a copyright notice: Copyright © 2012 D-Link Corporation/D-Link Systems, Inc.

Wireless Setup

Here, you can configure the wireless network settings of the DIR-505. After making your changes, click the **Save Settings** button.

Wireless Network Name: When you are browsing for available wireless networks, this is the name that will appear in the list (unless Visibility Status is set to Invisible, see below). This name is also referred to as the SSID. For security purposes, it is highly recommended to change from the default network name.

Wireless Mode: Select one of the following based on your needs:

- **802.11b Only:** Select this if you are only using 802.11b wireless clients.
- **802.11g Only:** Select this if you are only using 802.11g wireless clients.
- **802.11n Only:** Select this if you are only using 802.11n wireless clients.
- **Mixed 802.11g and 802.11b:** Select this if you are using a mix of 802.11g and 11b wireless clients.
- **Mixed 802.11n and 802.11g:** Select this if you are using a mix of 802.11n and 11g wireless clients.
- **Mixed 802.11n, 802.11g and 802.11b:** Select this if you are using a mix of 802.11n, 11g, and 11b wireless clients.

Enable Auto Channel Scan: The **Auto Channel Scan** setting can be selected to allow the DIR-505 to choose the channel with the least amount of interference.

Wireless Channel: Indicates the channel setting for the DIR-505. The Channel can be changed to fit the channel setting for an existing wireless network or to customize the wireless network. If you enable Auto Channel Scan, this option will be grayed out.

Channel Select whether to use **Auto 20/40 MHz** or **20 MHz** for the

The screenshot shows the D-Link DIR-505 wireless setup interface. The page is titled "D-Link" and has a navigation menu with "DIR-505 // AP", "SETUP", "ADVANCED", "MAINTENANCE", "STATUS", and "HELP". The "WIRELESS" section is active, showing the following settings:

- Wireless Network Name:** MobileCompanion-Claire (Also called the SSID)
- Wireless Band:** 2.4GHz
- Wireless Mode:** Mixed 802.11n, 802.11g and 802.11b
- Enable Auto Channel Scan:**
- Wireless Channel:** 2.412 GHz - CH 1
- Channel Width:** Auto 20/40 MHz
- Visibility Status:** Visible Invisible
- Wireless Security Mode:** Security Mode: WPA-Personal
- WPA:** Use WPA or WPA2 mode to achieve a balance of strong security and best compatibility. This mode uses WPA for legacy clients while maintaining higher security with stations that are WPA2 capable. Also the strongest cipher that the client supports will be used. For best security, use WPA2 Only mode. This mode uses AES(CCMP) cipher and legacy stations are not allowed access with WPA security. For maximum compatibility, use WPA Only. This mode uses TKIP cipher. Some gaming and legacy devices work only in this mode. To achieve better wireless performance use WPA2 Only security mode (or in other words AES cipher). WPA Mode: Auto (WPA or WPA2) Cipher Type: TKIP and AES
- PRE-SHARED KEY:** Enter an 8 to 63 character alphanumeric pass-phrase. For good security it should be of ample length and should not be a commonly known phrase. Pre-Shared Key:

Helpful Hints...: Changing your Wireless Network Name is the first step in securing your wireless network. Change it to a familiar name that does not contain any personal information. Enable Auto Channel Scan so that the Access Point can select the best possible channel for your wireless network to operate on. Visibility Status is another way to secure your network. With invisible option enabled, no wireless clients will be able to see your wireless network when they perform scan to see what's available. In order for your wireless devices to connect to your AP, you will need to manually enter the Wireless Network Name on each device. If you have enabled Wireless Security, make sure you write down the Key or Passphrase that you have configured. You will need to enter this information on any wireless device that you connect to your wireless network.

Width: channel width. Normally, this should be left on **Auto 20/40 MHz**. If you are not using any 802.11n wireless clients, you can set this to **20 MHz**.

Visibility Status: This setting controls whether the router's wireless network name (SSID) will be broadcast so that wireless devices can scan for it. If you set it to **Invisible**, all wireless clients will need to enter the network name and security settings of your wireless network manually.

Wireless Security Mode: Here, you can select between **None**, **WEP**, **WPA-Personal**, and **WPA-Enterprise**. Refer to the following pages for details on configuring the different security modes.

WIRELESS NETWORK SETTINGS	
Wireless Network Name :	MobileCompanion-Claire (Also called the SSID)
Wireless Band :	2.4GHz
Wireless Mode :	Mixed 802.11n, 802.11g and 802.11b
Enable Auto Channel Scan :	<input checked="" type="checkbox"/>
Wireless Channel :	2.412 GHz - CH 1
Channel Width :	Auto 20/40 MHz
Visibility Status :	<input checked="" type="radio"/> Visible <input type="radio"/> Invisible

WIRELESS SECURITY MODE	
Security Mode :	WPA-Personal

If you select **WEP** as your Security Mode:

WEP Key Select an encryption level and key length to use. This will
Length: also set the type and length of the key you will need to enter.

WEP Key: Enter the password(key) for your wireless network. It will
 need to match the requirements for the WEP Key Length
 selected above.

Authentication: Choose what Authentication type to use.

WIRELESS SECURITY MODE

Security Mode :

WEP

WEP is the wireless encryption standard. To use it you must enter the same key(s) into the router and the wireless stations. For 64 bit keys you must enter 10 hex digits into each key box. For 128 bit keys you must enter 26 hex digits into each key box. A hex digit is either a number from 0 to 9 or a letter from A to F. For the most secure use of WEP set the authentication type to "Shared Key" when WEP is enabled.

You may also enter any text string into a WEP key box, in which case it will be converted into a hexadecimal key using the ASCII values of the characters. A maximum of 5 text characters can be entered for 64 bit keys, and a maximum of 13 characters for 128 bit keys.

If you choose the WEP security option this device will **ONLY** operate in **Legacy Wireless mode (802.11B/G)**. This means you will **NOT** get 11N performance due to the fact that WEP is not supported by the Draft 11N specification.

WEP Key Length : (length applies to all keys)

WEP Key 1 :

Authentication :

If you select **WPA-Personal** as your Security Mode:

WPA Mode: Select whether to use **WPA, WPA2**, or both **WPA and WPA2**
 for your wireless network..

Cipher Type: Choose whether to use **TKIP, AES**, or both **TKIP and AES**
 ciphers for your wireless network.

Pre-Shared Key: Enter the password(key) for your wireless network.

WIRELESS SECURITY MODE

Security Mode :

WPA

Use **WPA or WPA2** mode to achieve a balance of strong security and best compatibility. This mode uses WPA for legacy clients while maintaining higher security with stations that are WPA2 capable. Also the strongest cipher that the client supports will be used. For best security, use **WPA2 Only** mode. This mode uses AES(CCMP) cipher and legacy stations are not allowed access with WPA security. For maximum compatibility, use **WPA Only**. This mode uses TKIP cipher. Some gaming and legacy devices work only in this mode.

To achieve better wireless performance use WPA2 Only security mode (or in other words AES cipher).

WPA Mode :

Cipher Type :

PRE-SHARED KEY

Enter an 8 to 63 character alphanumeric pass-phrase. For good security it should be of ample length and should not be a commonly known phrase.

Pre-Shared Key :

If you select **WPA-Enterprise** as your Security Mode:

WPA Mode: Select whether to use **WPA**, **WPA2**, or both **WPA and WPA2** for your wireless network..

Cipher Type: Choose whether to use **TKIP**, **AES**, or both **TKIP and AES** ciphers for your wireless network.

Pre-Shared Key: Enter the password(key) for your wireless network.

RADIUS Server IP Address: Enter your RADIUS server IP address.

RADIUS Server Port: Enter your RADIUS server port.

RADIUS Server Shared Secret: Enter your RADIUS server shared secret.

WIRELESS SECURITY MODE

Security Mode :

WPA

Use **WPA** or **WPA2** mode to achieve a balance of strong security and best compatibility. This mode uses WPA for legacy clients while maintaining higher security with stations that are WPA2 capable. Also the strongest cipher that the client supports will be used. For best security, use **WPA2 Only** mode. This mode uses AES(CCMP) cipher and legacy stations are not allowed access with WPA security. For maximum compatibility, use **WPA Only**. This mode uses TKIP cipher. Some gaming and legacy devices work only in this mode.

To achieve better wireless performance use WPA2 Only security mode (or in other words AES cipher).

WPA Mode :

Cipher Type :

EAP (802.1X)

When WPA enterprise is enabled, the router uses EAP (802.1x) to authenticate clients via a remote RADIUS server.

RADIUS Server IP Address :

RADIUS Server Port :

RADIUS Server Shared Secret :

LAN Setup

Here, you can configure the network settings of the DIR-505. After making your changes, click the **Save Settings** button.

Operation Mode: This should be set to **Access Point** mode. If you want to use Router mode, select **Router** mode and click the **Save Settings** button to switch to the Router configuration interface. For more information, refer to "Router Mode" on page 24.

Device Name: Enter a name for the DIR-505.

My LAN Connection Select whether you want to connect your DIR-505 to your network through **Dynamic IP (DHCP)** or **Static IP**.
is:

If you selected **Static IP**, fill in the **IP Address**, **Subnet Mask**, **Gateway Address**, and **Primary** and **Secondary DNS Server** addresses. If you are not sure what settings to use, please contact your network administrator or Internet service provider.

D-Link

DIR-505 // AP SETUP ADVANCED MAINTENANCE STATUS HELP

SETUP WIZARD
WIRELESS SETUP
LAN SETUP

NETWORK SETTINGS

Use this section to configure the internal network settings of your AP.
Device Name allows you to configure this device more easily when your network using TCP/IP protocol. You can enter the device name of the AP into your web browser to access the instead of IP address for configuration. Recommend to change the device name if there're more than one D-Link devices within the subnet.

Save Settings Don't Save Settings

OPERATION MODE SETTING

Operation Mode : Access Point

DEVICE NAME

Device Name allows you to configure this device more easily. You can enter "http://"device name" into your web browser instead of IP address for configuration. (Default: http://dlinkrouter)

Device Name : dlinkrouter

LAN IPV4 CONNECTION TYPE

Choose the IPv4 mode to be used by the Access Point.

My LAN Connection is : Dynamic IP (DHCP)

DYNAMIC IP(DHCP) LAN CONNECTION TYPE

Enter the IPv4 Address Information.

IP Address : 192.168.0.1
Subnet Mask : 255.255.255.0
Gateway Address : 0.0.0.0
Primary DNS Server : 0.0.0.0
Secondary DNS Server : 0.0.0.0

Helpful Hints...

Device Name: Device Name allows you to configure this device more easily when your network using TCP/IP protocol. You can enter the device name of the AP into your web browser to access the device configuration. Recommend to change the device name if there're more than one D-Link devices within the network.

LAN Settings: Also referred as private settings. LAN settings allow you to configure LAN interface of DIR-505. LAN IP address is private to your internal network and is not visible to Internet. The factory default setting is Dynamic IP(DHCP).

WIRELESS

Copyright © 2012 D-Link Corporation/D-Link Systems, Inc.

Advanced MAC Address Filter

Use MAC (Media Access Control) Filters to control access to your network based on the MAC addresses of connected clients. You can set MAC address filtering to only allow the listed MAC addresses to connect, or block access to all listed MAC addresses. After making your changes, click the **Save Settings** button.

Wireless Access Settings: Configure how MAC filtering works by using the dropdown box to select an option:

Turn MAC Filtering OFF: This disables MAC filtering.

Turn MAC Filtering ON and ALLOW computers listed to access the network: When this option is selected, only PCs and devices with MAC addresses in the MAC Address List are granted network access. All other devices will be blocked.

Turn MAC Filtering ON and DENY computers listed to access the network: When this option is selected, all PCs and devices with MAC addresses in the MAC Address List will be refused access to your network. All other devices will be allowed access.

MAC Address: Enter the MAC addresses you would like to filter. You can select a client currently connected to your access point from the **Wireless Client List** drop-down menu and then click the corresponding << button fill in the MAC address automatically. Click the Clear button to remove any entered MAC address.

D-Link

DIR-505 // AP SETUP **ADVANCED** MAINTENANCE STATUS HELP

MAC ADDRESS FILTER

MAC ADDRESS FILTER

The MAC (Media Access Controller) Address filter option is used to control network access based on the MAC Address of the network adapter. A MAC address is a unique ID assigned by the manufacturer of the network adapter. This feature can be configured to ALLOW or DENY network/Internet access.

Save Settings Don't Save Settings

WIRELESS ACCESS SETTINGS

Configure MAC Filtering below:

Turn MAC Filtering OFF

MAC Address	Wireless Client List	
00:00:00:00:00:00	<< MAC Address	Clear
00:00:00:00:00:00	<< MAC Address	Clear
00:00:00:00:00:00	<< MAC Address	Clear
00:00:00:00:00:00	<< MAC Address	Clear
00:00:00:00:00:00	<< MAC Address	Clear
00:00:00:00:00:00	<< MAC Address	Clear

WIRELESS

Copyright © 2012 D-Link Corporation/D-Link Systems, Inc.

Helpful Hints...

Create a list of MAC address that you would either like to allow or deny access to your network.

Select a MAC address from the drop down menu, then click the arrow to add that MAC address to the list.

Click the Clear button to remove the MAC address from the MAC Filtering list.

Advanced Wireless

This screen allows you to set various advanced wireless settings of your DIR-505. Unless you are experiencing specific problems, it is recommended that you leave these settings at their default values. After making your changes, click the **Save Settings** button.

Transmit Power: Use the dropdown box to set the transmit power of the antennas.

WMM Enable: WMM is Quality of Service(QoS) for your wireless network. This will improve the quality of video and voice applications for your wireless clients.

Short GI: Check this box to reduce the guard interval time therefore increasing the data capacity. However, this may create a less reliable connection and may create higher data loss.

IGMP Snooping: Tick this checkbox to enable this feature.

WLAN Partition: This enables 802.11d operation. 802.11d is a wireless specification developed to allow implementation of wireless networks in countries that cannot use the 802.11 standard. This feature should only be enabled if you are in a country that requires it.

HT 20/40 Coexistence: Tick this checkbox to enable this feature.

D-Link

DIR-505 // AP

SETUP ADVANCED MAINTENANCE STATUS HELP

MAC ADDRESS FILTER

ADVANCED WIRELESS

WI-FI PROTECTED SETUP

USER LIMIT

ADVANCED WIRELESS

These options are for users that wish to change the behaviour of their 802.11n wireless radio from the standard setting. D-Link does not recommend changing these settings from the factory default. Incorrect settings may impair the performance of your wireless radio. The default settings should provide the best wireless radio performance in most environments.

Save Settings Don't Save Settings

ADVANCED WIRELESS SETTINGS

Transmit Power : 100%

WMM Enable :

Short GI :

IGMP Snooping :

WLAN Partition :

HT20/40 Coexistence : Enable Disable

Helpful Hints...

Advanced Wireless: It is recommended that you leave these options at their default values. Adjusting them could negatively impact the performance of your wireless network. The options on this page should be changed by advanced users or if you are instructed to by one of our support personnel, as they can negatively affect the performance of your Access Point if configured improperly.

Transmit Power: You can lower the output power of the DIR-505 by selecting lower percentage Transmit Power values from the drop down. Your choices are: 100%, 75%, 50%, and 25%.

WIRELESS

Copyright © 2012 D-Link Corporation/D-Link Systems, Inc.

Wi-Fi Protected Setup (WPS)

Wi-Fi Protected Setup (WPS) System is a simplified way to set up the basic settings of the DIR-505. It can also be used to automatically create a secure wireless connection to a wireless client. After making your changes, click the **Save Settings** button.

Enable: Check this box to enable the WPS functions of the DIR-505.

Disable WPS PIN Method: Disabling this will disable the WPS PIN method of connection and configuration. If you want to reconfigure the router using the WPS PIN method, click on the **Reset to Unconfigured** button. You will still be able to add wireless clients through WPS.

PIN Settings: Shows the router's current PIN. You can reset it to the default value by clicking on the **Reset PIN to Default** button, or you can create a new PIN number by clicking on the **Generate New PIN** button.

Add Wireless Station: Here, you can click on the **Add Wireless Device With WPS** button to go through a wizard that helps you connect other devices through WPS.

The screenshot displays the D-Link DIR-505 web interface. The top navigation bar includes 'D-Link', 'DIR-505 // AP', and tabs for 'SETUP', 'ADVANCED', 'MAINTENANCE', 'STATUS', and 'HELP'. The 'ADVANCED' tab is selected, and the 'WI-FI PROTECTED SETUP' section is active. The interface is divided into a main content area and a right-hand sidebar.

Main Content Area:

- WI-FI PROTECTED SETUP:** Contains explanatory text: "Wi-Fi Protected Setup is used to easily add devices to a network using a PIN or button press. Devices must support Wi-Fi Protected Setup in order to be configured by this method. If the PIN changes, the new PIN will be used in following Wi-Fi Protected Setup process. Clicking on 'Don't Save Settings' button will not reset the PIN. However, if the new PIN is not saved, it will get lost when the device reboots or loses power." Below this text are two buttons: "Save Settings" and "Don't Save Settings".
- WI-FI PROTECTED SETUP (Configuration):** A section with two checked checkboxes: "Enable" and "Disable WPS-PIN Method". A "Reset to Unconfigured" button is located below these checkboxes.
- PIN SETTINGS:** Shows the "Current PIN: 57893402". Below this are two buttons: "Reset PIN to Default" and "Generate New PIN".
- ADD WIRELESS STATION:** A section with a single button: "Add Wireless Device With WPS".

Right-Hand Sidebar:

- Helpful Hints...:** Contains text: "Enable if other wireless devices you wish to include in the local network support Wi-Fi Protected Setup." and "Click Add Wireless Device Wizard to use Wi-Fi Protected Setup to add wireless devices to the wireless network."

Bottom of Page:

- A "WIRELESS" section header.
- Copyright © 2012 D-Link Corporation/D-Link Systems, Inc.

User Limit

You can limit the number of wireless clients that can connect to your wireless network. Doing so can help prevent the DIR-505 from being overloaded trying to provide service to too many clients, and helps ensure your wireless network runs smoothly. After making your changes, click the **Save Settings** button.

Enable User Limit: Check this box to enable the User Limit feature.

User Limit (1-32): After enabling User Limits, enter the maximum number of wireless clients that can be connected to your wireless network. You can enter a number from 1 to 32.

The screenshot shows the D-Link DIR-505 AP web interface. The top navigation bar includes the D-Link logo and tabs for SETUP, ADVANCED, MAINTENANCE, STATUS, and HELP. The main content area is titled 'USER LIMIT SETTINGS' and contains the following elements:

- A message: "Please Apply the settings to limit how many wireless stations connecting to AP."
- Buttons: "Save Settings" and "Don't Save Settings".
- Settings:
 - Enable User Limit :**
 - User Limit(1 - 32) :**

On the right side, there is a 'Helpful Hints...' section with the following text: "User Limit can set a limit upon the number of wireless clients. Using user limit, you can prevent scenarios where the DIR-505 in your network shows performance degradation because it is handling heavy wireless traffic."

The bottom of the page features a 'WIRELESS' section header and a copyright notice: "Copyright © 2012 D-Link Corporation/D-Link Systems, Inc."

Maintenance Admin

This page will allow you to change the password for the administrator account for configuring the settings of the DIR-505. You can also turn on graphical authentication(CAPTCHA) on this page. After making your changes, click the **Save Settings** button.

New Password: Enter a new password for the Administrator Login Name. The administrator can make changes to the settings.

Verify Password: Enter the same password that you entered in the previous textbox in order to confirm its accuracy.

Enable Graphical Authentication: Check to enable Graphical Authentication, or CAPTCHAs when logging in to the web UI of the DIR-505. This provides an extra layer of security by requiring you to enter a code that is displayed on-screen.

The screenshot displays the D-Link web management interface for the DIR-505. The main content area is titled 'ADMINISTRATOR SETTINGS' and contains the following elements:

- ADMINISTRATOR SETTINGS:** A section with instructions: "Enter the new password in the 'New Password' field and again in the next field to confirm. Click on 'Save Settings' to execute the password change. The Password is case-sensitive, and can be made up of any keyboard characters. The new password must be between 0 and 15 characters in length." Below this are two buttons: "Save Settings" and "Don't Save Settings".
- PASSWORD:** A section with the instruction: "Please enter the same password into both boxes, for confirmation." It contains two password input fields: "New Password : *****" and "Verify Password : *****".
- ADMINISTRATION:** A section with a checkbox labeled "Enable Graphical Authentication : ".

The interface also features a left-hand navigation menu with options like ADMIN, SYSTEM, FIRMWARE, TIME, SYSTEM CHECK, and SCHEDULES. A right-hand sidebar provides "Helpful Hints..." regarding password security. The footer includes the "WIRELESS" logo and copyright information: "Copyright © 2012 D-Link Corporation/D-Link Systems, Inc."

System

This page allows you to save and restore your configuration, reset and reboot the DIR-505, and remove any added language packs.

Save Settings To Local Hard Drive: Clicking the **Save** button will allow you to save the current repeater configuration settings to a file on the hard disk of the computer you are using. You will then see a file dialog where you can select a location and file name for the settings.

Load Settings From Local Hard Drive: Use this option to load previously saved configuration settings. Click **Browse** to find a previously saved configuration file. Then, click the **Upload Settings** button to transfer those settings to the DIR-505.

Restore to Factory Default Settings: This option will restore all configuration settings back to the factory default settings. Any settings that have not been saved will be lost, including any rules that you have created. If you want to save your current configuration settings, use the **Save** button above.

Note: Restoring the factory default settings will not reset the Wi-Fi Protected Status to Not Configured.

Reboot the Device: Click the **Reboot** button to reboot the repeater.

Remove Language Pack: If you have previously installed a Language Pack, you can remove it by clicking the Remove button.

The screenshot shows the D-Link DIR-505 web interface. The top navigation bar includes 'DIR-505 // AP', 'SETUP', 'ADVANCED', 'MAINTENANCE', 'STATUS', and 'HELP'. The 'MAINTENANCE' tab is selected, displaying the 'SAVE AND RESTORE' page. The page content includes a warning message: 'The current system settings can be saved as a file onto the local hard drive. You can upload any save settings file that was created by the DIR-505.' Below this, there are sections for 'Save Settings To Local Hard Drive' (with a 'Save' button), 'Load Settings From Local Hard Drive' (with a 'Choose File' button and 'No file chosen' text), 'Restore To Factory Default Settings' (with a 'Restore Device' button), 'Reboot The Device' (with a 'Reboot' button), and 'Remove Language Pack' (with a 'Remove' button). A 'Helpful Hints...' sidebar on the right provides instructions on saving and restoring settings. The footer of the interface shows 'WIRELESS' and 'Copyright © 2012 D-Link Corporation/D-Link Systems, Inc.'

Firmware

You can upgrade the firmware of the DIR-505 here. Make sure the firmware you want to use is on the local hard drive of the computer. Click on **Browse** to locate the firmware file to be used for the update. Please check the D-Link support website for firmware updates at <http://support.dlink.com>. You can download firmware upgrades to your hard drive from this site.

Firmware Upgrade: Click on **Check Now** to find out if there is an updated firmware; if so, download the new firmware to your hard drive.

After you have downloaded the new firmware, click **Browse** to locate the firmware update on your hard drive. Click **Upload** to complete the firmware upgrade. Do not disconnect from the DIR-505 or power your computer or DIR-505 off during the upgrade process.

You can change the language of the web UI by uploading available language packs.

Browse: Download a language pack from the D-Link website. After you have downloaded the new language pack, click **Browse** to locate the language pack file on your hard drive. Click **Upload** to complete the language pack upgrade.

The screenshot shows the D-Link web interface for the DIR-505. The top navigation bar includes 'DIR-505 // AP', 'SETUP', 'ADVANCED', 'MAINTENANCE', 'STATUS', and 'HELP'. The 'MAINTENANCE' tab is selected, and the 'FIRMWARE' sub-tab is active. The main content area is divided into several sections:

- FIRMWARE:** A notice stating that there may be new firmware for the DIR-505 to improve functionality and performance. It includes a link to check for updates on the support site and instructions to click 'Browse' to find the file on the local hard drive and 'Upload' to update it. A warning states: "Do not update firmware through wireless network!!".
- FIRMWARE AND LANGUAGE PACK INFORMATION:** Displays the current firmware version as 1.05 and the date as 2012/9/19. The current language pack version is listed as 'No Language pack'. A 'Check Online Now' button is provided to check for the latest versions.
- FIRMWARE UPGRADE:** Contains a note that some firmware upgrades reset configuration options to factory defaults. It instructs users to save their current configuration from the Maintenance > System screen. Below this, there is an 'Upload' section with a text input field and a 'Browse...' button, followed by an 'Upload' button.
- LANGUAGE PACK UPGRADE:** Similar to the firmware upgrade section, it has an 'Upload' section with a text input field, a 'Browse...' button, and an 'Upload' button.

On the right side of the interface, there is a 'Helpful Hints...' section titled 'Firmware Updates', which explains that updates are released periodically to improve functionality and add features, and provides instructions on how to check for updates on the support site.

Time

The Time page allows you to configure, update, and maintain the correct time on the internal system clock. From this section you can set the time zone that you are in. Daylight Saving can also be configured to automatically adjust the time when needed. After making your changes, click the **Save Settings** button.

Time Zone: Select the Time Zone from the drop-down menu.

Enable Daylight Saving: To select Daylight Saving time manually, click the **Enable Daylight Saving** check box. Next use the drop-down menu to select a **Daylight Saving Offset** and then enter a start date and an end date for daylight saving time.

Enable NTP Server: NTP is short for Network Time Protocol. NTP synchronizes computer clock times in a network of computers. Check this box to use a NTP server. This will only connect to a server on the Internet, not a local server.

NTP Server Used: Enter the NTP server or select one from the drop-down menu.

Date and Time: To manually input the time, enter the values in these fields for the Year, Month, Day, Hour, Minute, and Second and then click **Save Settings**. You can also click the **Copy Your Computer's Time Settings** button at the bottom of the screen.

The screenshot shows the D-Link DIR-505 AP web interface. The top navigation bar includes 'D-Link', 'DIR-505 // AP', and tabs for 'SETUP', 'ADVANCED', 'MAINTENANCE', 'STATUS', and 'HELP'. The 'TIME' section is active, displaying the following configuration options:

- TIME:** The Time Configuration option allows you to configure, update, and maintain the correct time on the internal system clock. From this section you can set the time zone that you are in and set the NTP (Network Time Protocol) Server. Daylight Saving can also be configured to automatically adjust the time when needed. Buttons: Save Settings, Don't Save Settings.
- TIME CONFIGURATION:**
 - Current Time: Jan/01/2011 03:30:55
 - Time Zone: (GMT-08:00) Pacific Time (US/Canada), Tijuana
 - Enable Daylight Saving:
 - Daylight Saving Offset: +1:00
 - Daylight Saving Dates:

DST start	Month	Week	Day of Week	Time
Mar	3rd	Sun	1 am	
DST End	Nov	2nd	Sun	1 am
- AUTOMATIC TIME CONFIGURATION:**
 - Enable NTP Server:
 - NTP Server Used: << Select NTP Server
- SET THE DATE AND TIME MANUALLY:**
 - Date And Time: Year 2011, Month Jan, Day 01, Hour 00, Minute 00, Second 00
 - Copy Your Computer's Time Settings

At the bottom of the page, there is a 'WIRELESS' section and a copyright notice: Copyright © 2012 D-Link Corporation/D-Link Systems, Inc.

System Check

This page allows you to run a ping test to check your Internet connectivity.

The Ping Test is used to send ping packets to test if your DIR-505 is connected to the Internet. Enter the IP address that you wish to ping and click the **Ping** button.

The results of your ping attempts will be displayed here.

The screenshot shows the D-Link DIR-505 AP web interface. The top navigation bar includes the D-Link logo and tabs for SETUP, ADVANCED, MAINTENANCE, STATUS, and HELP. The left sidebar contains a menu with options: ADMIN, SYSTEM, FIRMWARE, TIME, SYSTEM CHECK, and SCHEDULES. The main content area is titled "PING TEST" and contains the following text: "Ping Test sends 'ping' packets to test a computer on the Internet." Below this is a form with a label "Host Name or IP Address:" followed by a text input field and a "Ping" button. Underneath the form is a section titled "PING RESULT" with the instruction "Enter a host name or IP address above and click 'Ping'". On the right side of the interface, there is a "Helpful Hints..." section with a "More..." link. The footer of the page displays "WIRELESS" and the copyright notice "Copyright © 2012 D-Link Corporation/D-Link Systems, Inc."

Schedules

You can create schedules for use with some of the features of the DIR-505, which will allow those features to be active during certain times of the day or week.

Name: Enter a name for your new schedule.

Days: Select a day, a range of days, or All Week to include every day of the week.

Time format: Check **All Day - 24hrs** or enter a start and end times for your schedule.

Save: After entering the details of your schedule, click the **Save** button to save your changes.

Schedule Rules List: The list of created schedules will be listed here. Click the **Edit** icon to make changes or click the **Delete** icon to remove the schedule.

D-Link

DIR-505 // AP SETUP ADVANCED MAINTENANCE STATUS HELP

SCHEDULES

The Schedule configuration option is used to manage schedule rules for wireless Lan control features.

ADD SCHEDULE RULE

Name :

Day(s) : All Week : Select Day(s) :

Sun Mon Tue Wed Thu Fri Sat

All Day - 24 hrs :

Time format :

Start Time : : (hour:minute)

End Time : : (hour:minute)

SCHEDULE RULES LIST

Name	Day(s)	Time Frame		

WIRELESS

Copyright © 2012 D-Link Corporation/D-Link Systems, Inc.

Helpful Hints...

Schedules are used with a number of other features to define when those features are in effect.

Give each schedule a name that is meaningful to you. For example, a schedule for Monday through Friday from 3:00pm to 9:00pm, might be called "After School".

Click **Save** to add a completed schedule to the list below.

Click the **Edit** icon to change an existing schedule.

Click the **Delete** icon to permanently delete a schedule.

Status

Device Info

This page displays the current information for the DIR-505. It will display the LAN and wireless LAN information.

General: Displays the time and firmware version.

LAN: Displays the MAC address and the private (local) IP settings for the access point.

Wireless LAN: Displays the wireless MAC address and your wireless settings such as SSID and Channel.

The screenshot shows the D-Link DIR-505 web interface. The top navigation bar includes 'DIR-505 // AP', 'SETUP', 'ADVANCED', 'MAINTENANCE', 'STATUS', and 'HELP'. The 'STATUS' page is active, displaying the following information:

DEVICE INFORMATION	Helpful Hints...
<p>All of your wireless and network connection details are displayed on this page. The firmware version is also displayed here.</p> <p>GENERAL</p> <p>Time : Jan/01/2011 03:34:41 Firmware Version : 1.00, Wed, 29 Feb 2012</p> <p>LAN</p> <p>MAC Address : 00:18:e7:95:6d:c8 Connection : Dynamic IP IP Address : 169.254.122.65 Subnet Mask : 255.255.0.0 Gateway Address : 0.0.0.0</p> <p>WIRELESS LAN</p> <p>MAC Address : 00:18:e7:95:6d:c8 Network Name (SSID) : MobileCompanion-Claire Channel : 1 Security Mode : Auto (WPA or WPA2) Wi-Fi Protected Setup : Enable / Configured</p>	<p>All of your LAN and Wireless connection details are displayed here.</p>

At the bottom of the page, the 'WIRELESS' section is visible, along with the copyright notice: Copyright © 2012 D-Link Corporation/D-Link Systems, Inc.

Logs

The DIR-505 keeps a running log of events and activities occurring on the DIR-505. If the DIR-505 is rebooted, the logs are automatically cleared.

Log Options: There are several types of logs that can be viewed: **System Activity, Debug Information, Attacks, Dropped Packets** and **Notice**.

First Page: This button directs you to the first page of the log.

Last Page: This button directs you to the last page of the log.

Previous: This button directs you to the previous page of the log.

Next: This button directs you to the next page of the log.

Clear: This button clears all current log content.

Save Log: This button opens dialog where you can save the current log to your hard drive.

Refresh: This button refreshes the log.

D-Link

DIR-505 // AP SETUP ADVANCED MAINTENANCE STATUS HELP

LOGS

Use this option to view the device logs. You can define what types of events you want to view and the event levels to view.

LOG OPTIONS

Log Type : System Activity Debug Information Attacks
 Dropped Packets Notice

Apply Log Settings Now

LOG DETAILS

First Page Last Page Previous Next Clear Save Log

Refresh

1/4

Time	Message
Jan 1 03:30:08	ath0: STA 28:e0:2c:dc:0a:be WPA: group key handshake completed (RSN)
Jan 1 03:30:08	ath0: STA 00:24:2c:2b:a7:dc WPA: group key handshake completed (RSN)
Jan 1 03:20:08	ath0: STA 00:24:2c:2b:a7:dc WPA: group key handshake completed (RSN)
Jan 1 03:20:08	ath0: STA 28:e0:2c:dc:0a:be WPA: group key handshake completed (RSN)
Jan 1 03:10:08	ath0: STA 28:e0:2c:dc:0a:be WPA: received EAPOL-Key 2/2 Group with unexpected replay counter
Jan 1 03:10:08	ath0: STA 28:e0:2c:dc:0a:be WPA: group key handshake completed (RSN)
Jan 1 03:10:07	ath0: STA 00:24:2c:2b:a7:dc WPA: group key handshake completed (RSN)
Jan 1 03:00:08	ath0: STA 28:e0:2c:dc:0a:be WPA: received EAPOL-Key 2/2 Group with unexpected replay counter
Jan 1 03:00:08	ath0: STA 28:e0:2c:dc:0a:be WPA: group key handshake completed (RSN)
Jan 1 03:00:07	ath0: STA 00:24:2c:2b:a7:dc WPA: group key handshake completed (RSN)

WIRELESS

Copyright © 2012 D-Link Corporation/D-Link Systems, Inc.

Statistics

The DIR-505 keeps statistics of the traffic that passes through it. You can view the amount of packets that pass through the LAN and wireless portions of the network. Click the **Refresh Statistics** button to update the information, or click the **Clear Statistics** button to reset all statistics. The traffic counter will reset if the DIR-505 is rebooted.

The screenshot shows the D-Link DIR-505 web interface. The top navigation bar includes 'DIR-505 // AP', 'SETUP', 'ADVANCED', 'MAINTENANCE', 'STATUS', and 'HELP'. The left sidebar contains 'DEVICE INFO', 'LOGS', 'STATISTICS', and 'WIRELESS'. The main content area is titled 'TRAFFIC STATISTICS' and includes a description: 'Traffic Statistics display Receive and Transmit packets passing through your router.' Below this are two buttons: 'Refresh Statistics' and 'Clear Statistics'. The statistics are divided into 'LAN STATISTICS' and 'WIRELESS STATISTICS', each with a table of metrics.

LAN STATISTICS	
Sent : 39010	Received : 67349
TX Packets Dropped : 0	RX Packets Dropped : 0
Collisions : 0	Errors : 0

WIRELESS STATISTICS	
Sent : 88449	Received : 75059
TX Packets Dropped : 14	RX Packets Dropped : 0
Collisions : 0	Errors : 0

Helpful Hints... This is a summary of the number of packets that have passed between the Wireless and the LAN since the device was last initialized.

WIRELESS

Copyright © 2012 D-Link Corporation/D-Link Systems, Inc.

Wireless

The wireless client table displays a list of current connected wireless clients. This table also displays the connection time and MAC address of the connected wireless clients.

The screenshot shows the D-Link DIR-505 AP web interface. The top navigation bar includes tabs for SETUP, ADVANCED, MAINTENANCE, STATUS, and HELP. The left sidebar contains menu items for DEVICE INFO, LOGS, STATISTICS, and WIRELESS. The main content area is titled 'WIRELESS' and contains a descriptive paragraph, a table showing the number of wireless clients (2), and a table listing the connected clients with their connection times and MAC addresses. A 'Helpful Hints...' section is visible on the right side of the main content area.

Connected Time	MAC Address
03:35:50	00:24:2c:2b:a7:dc
02:01:38	28:e0:2c:dc:0a:be

WIRELESS

Copyright © 2012 D-Link Corporation/D-Link Systems, Inc.

Help

This screen gives you more information about the various parts of the configuration interface. Click on a link to learn more about that topic.

The screenshot shows the D-Link DIR-505 AP configuration interface. At the top, there is a navigation bar with the D-Link logo and tabs for SETUP, ADVANCED, MAINTENANCE, STATUS, and HELP. The HELP tab is selected. Below the navigation bar, there is a main content area with a 'HELP MENU' section. This section is divided into four categories: Setup, Advanced, Maintenance, and Status. Each category contains a list of links to specific configuration pages. To the right of the main content area, there is a 'Helpful Hints...' section with a brief instruction. At the bottom of the interface, there is a 'WIRELESS' section and a copyright notice.

D-Link

DIR-505 // AP SETUP ADVANCED MAINTENANCE STATUS HELP

MENU

HELP MENU

Setup

- [Wizard](#)
- [Wireless Setup](#)
- [Lan Setup](#)

Advanced

- [MAC Address Filter](#)
- [Advanced Wireless](#)
- [Wi-Fi Protected Setup](#)
- [User limit](#)

Maintenance

- [Admin](#)
- [System](#)
- [Firmware](#)
- [Time](#)
- [System Check](#)
- [Schedules](#)

Status

- [Device Info](#)
- [Logs](#)
- [Statistics](#)
- [Wireless](#)

Helpful Hints...

Click on the links for more informations of each section in the GUI.

WIRELESS

Copyright © 2012 D-Link Corporation/D-Link Systems, Inc.

Repeater Mode

This section describes the configuration interface for Repeater mode. Make sure that the mode selector switch is in the Repeater position on your DIR-505.

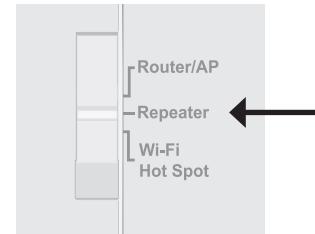

Setup Wizard

If you want to configure the Repeater Mode of the DIR-505 using a wizard, click **Launch Setup Wizard**.

To configure your DIR-505 manually, click **Wireless Setup** to configure your wireless connection or click **LAN Setup** to configure the LAN options.

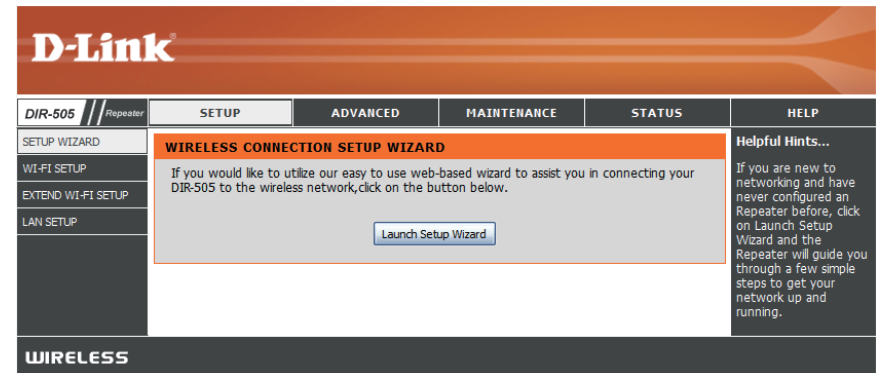

Setup Wizard

This Wizard is designed to assist you in configuring your DIR-505 as an repeater.

If this is the first time configuring your DIR-505, click **Next** to start the Setup Wizard.

Otherwise, click **Launch Wireless Setup Wizard** from the main menu.

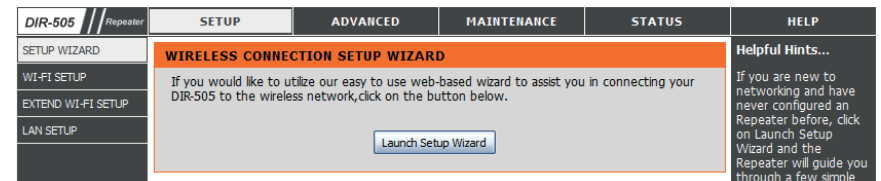
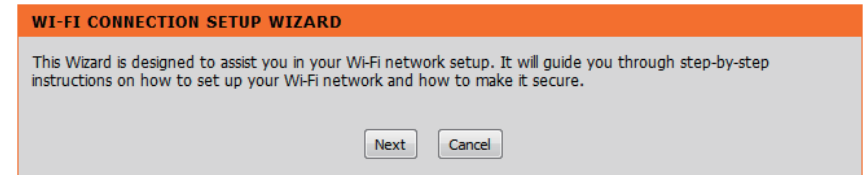

Select **WPS** as the configuration method only if your wireless device supports Wi-Fi Protected Setup (WPS). For **Manual** setup, skip to the next page.

Click **Next** to continue.

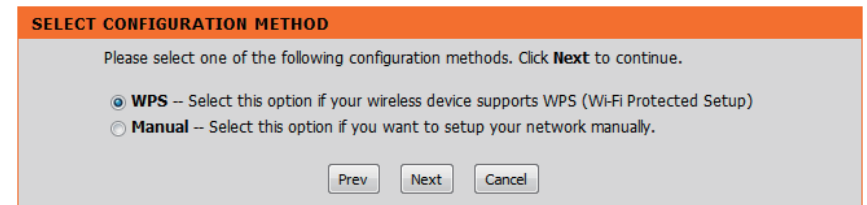

Press the **WPS button** on the wireless device you are adding to your wireless network.

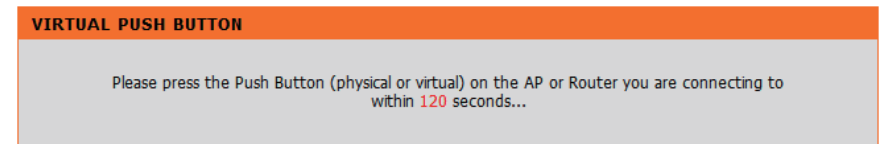

Select **Manual** as the configuration method to set up your network manually.

Click **Next** to continue.

SELECT CONFIGURATION METHOD

Please select one of the following configuration methods. Click **Next** to continue.

WPS -- Select this option if your wireless device supports WPS (Wi-Fi Protected Setup)

Manual -- Select this option if you want to setup your network manually.

Prev Next Cancel

Please wait while your device scans for available Wi-Fi networks.

SELECT WI-FI NETWORK

Scanning for available Wi-Fi network...

Prev Next Cancel

Select the network you would like your device to connect to and click **Connect** to continue.

SELECT WI-FI NETWORK

ID	Wi-Fi Network Name	Encrypt	Channel	Signal(%)	Select
1	Linksys Staples	WPA2-PSK	3	94	<input type="radio"/>
2	00265a493e08	WPA2-PSK	1	94	<input type="radio"/>
3	Cisco Staples	WPA/WPA2-PSK(auto)	1	94	<input type="radio"/>
4	CAMERA432	WPA/WPA2-PSK(auto)	3	94	<input type="radio"/>
5	DSR-500N_1	WPA2-PSK	6	94	<input type="radio"/>
6	mywirelessnetwork	WPA/WPA2-PSK(auto)	11	94	<input type="radio"/>
7	00265a493e1e	WPA2-PSK	11	94	<input type="radio"/>

If the Wi-Fi network requires a password, enter it when prompted and click **Next** to continue.

D-Link

ENTER WI-FI PASSWORD

Please enter Wi-Fi Password to establish wireless connection

Wi-Fi Password:

Prev Next Cancel

WIRELESS

You can choose to use the same Wi-Fi network name for your extended network, which allows you to use the same Wi-Fi login and password throughout your home. Alternatively, you can use a different Wi-Fi network name for the extended network by unchecking the on-screen checkbox.

If you choose to use a different Wi-Fi network name, uncheck the on-screen checkbox and enter a Wi-Fi network name and password to use, then click **Next**.

Click **Save** to save your changes and reboot the DIR-505.

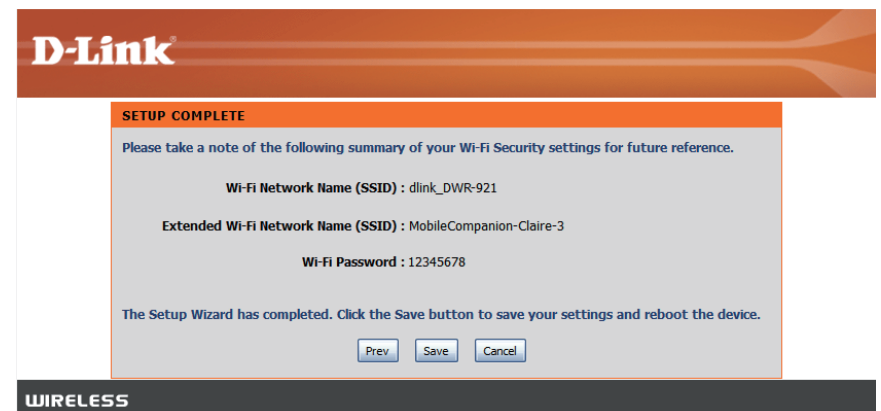
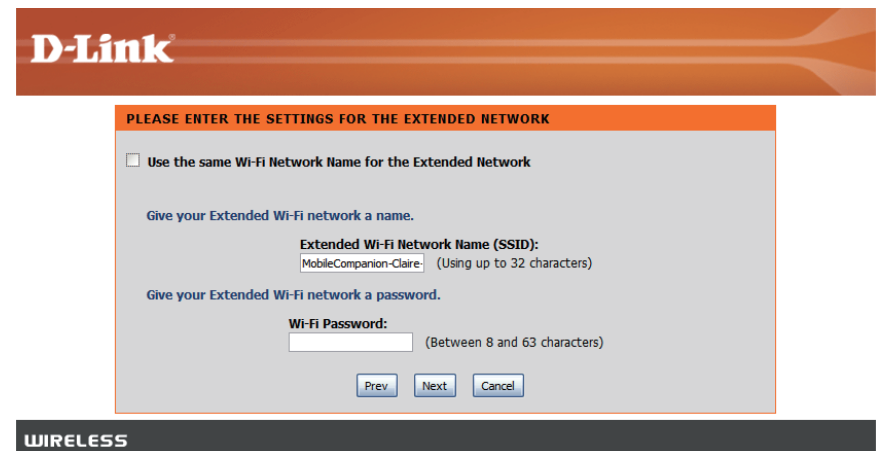
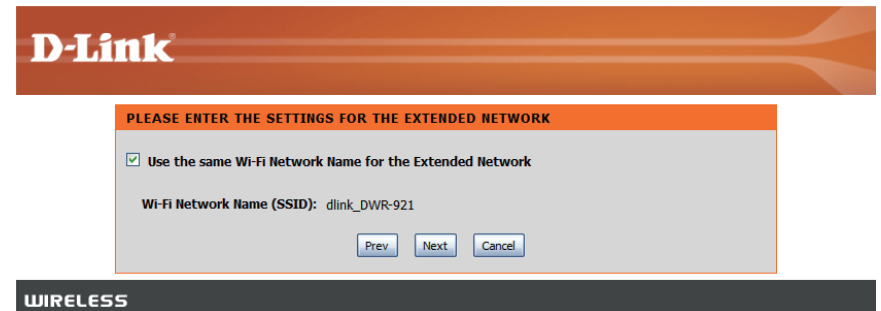

Wireless Setup

Use this section to manually configure the settings for your DIR-505's wireless connection to your router, or the wireless network you want to extend. After making your changes, click the **Save Settings** button.

Wireless Mode: This will state **Repeater Mode** when in Repeater Mode. You can click the **Site Survey** button to look for available wireless networks to extend. Selecting a wireless network from the list that appears will automatically fill in the settings below.

Wireless Network Name: When you are browsing for available wireless networks, this is the name that will appear in the list (unless Visibility Status is set to Invisible, see below). This name is also referred to as the SSID. For security purposes, it is highly recommended to change from the default network name.

Channel Width: Select the appropriate channel width between **20MHz** or **Auto 20/40MHz** from the drop-down menu.

Security Mode: Select **None**, **WEP**, or **WPA-Personal**. For security purposes, it is highly recommended that you set this to WPA-Personal.

Wi-Fi Protected Setup: Wi-Fi Protected Setup, or WCN, allows you to configure the basic settings of the DIR-505 through Windows. To enable this feature, check the **Enable** checkbox.

The screenshot displays the D-Link DIR-505 Repeater web interface. The top navigation bar includes 'D-Link', 'DIR-505 Repeater', and tabs for 'SETUP', 'ADVANCED', 'MAINTENANCE', 'STATUS', and 'HELP'. The 'SETUP' tab is active, showing a 'WI-FI' section with a 'Save Settings' button and a 'Don't Save Settings' button. Below this are three main configuration sections: 'WI-FI NETWORK SETTINGS' (with 'Wireless Mode' set to 'Repeater Mode' and a 'Site Survey' button, 'Wireless Network Name' set to 'Qqqqqqqqqq', and 'Channel Width' set to 'Auto 20/40 MHz'), 'WI-FI SECURITY MODE' (with 'Security Mode' set to 'None'), and 'WIFI PROTECTED SETUP (ALSO CALLED WCN 2.0 IN WINDOWS VISTA)' (with 'Enable' checked and a 'Process WPS' button). A 'Helpful Hints...' sidebar on the right provides instructions on using Site Survey. The footer shows 'WIRELESS' and 'Copyright © 2012 D-Link Corporation/D-Link Systems, Inc.'

If you select **WEP** as your Security Mode:

WEP Key Select an encryption level and key length to use. This will
Length: also set the type and length of the key you will need to enter.

WEP Key: Enter the password(key) for your wireless network. It will
 need to match the requirements for the WEP Key Length
 selected above.

Authentication: Choose what Authentication type to use.

WIRELESS SECURITY MODE

Security Mode :

WEP

WEP is the wireless encryption standard. To use it you must enter the same key(s) into the router and the wireless stations. For 64 bit keys you must enter 10 hex digits into each key box. For 128 bit keys you must enter 26 hex digits into each key box. A hex digit is either a number from 0 to 9 or a letter from A to F. For the most secure use of WEP set the authentication type to "Shared Key" when WEP is enabled.

You may also enter any text string into a WEP key box, in which case it will be converted into a hexadecimal key using the ASCII values of the characters. A maximum of 5 text characters can be entered for 64 bit keys, and a maximum of 13 characters for 128 bit keys.

If you choose the WEP security option this device will **ONLY** operate in **Legacy Wireless mode (802.11B/G)**. This means you will **NOT** get 11N performance due to the fact that WEP is not supported by the Draft 11N specification.

WEP Key Length : (length applies to all keys)

WEP Key 1 :

Authentication :

If you select **WPA-Personal** as your Security Mode:

WPA Mode: Select whether to use **WPA, WPA2**, or both **WPA and WPA2**
 for your wireless network..

Cipher Type: Choose whether to use **TKIP, AES**, or both **TKIP and AES**
 ciphers for your wireless network.

Pre-Shared Key: Enter the password(key) for your wireless network.

WIRELESS SECURITY MODE

Security Mode :

WPA

Use **WPA or WPA2** mode to achieve a balance of strong security and best compatibility. This mode uses WPA for legacy clients while maintaining higher security with stations that are WPA2 capable. Also the strongest cipher that the client supports will be used. For best security, use **WPA2 Only** mode. This mode uses AES(CCMP) cipher and legacy stations are not allowed access with WPA security. For maximum compatibility, use **WPA Only**. This mode uses TKIP cipher. Some gaming and legacy devices work only in this mode.

To achieve better wireless performance use WPA2 Only security mode (or in other words AES cipher).

WPA Mode :

Cipher Type :

PRE-SHARED KEY

Enter an 8 to 63 character alphanumeric pass-phrase. For good security it should be of ample length and should not be a commonly known phrase.

Pre-Shared Key :

Extend Wi-Fi Setup

Use this section to manually configure the wireless settings for your DIR-505's wireless extended network that connect your devices to. After making your changes, click the **Save Settings** button.

Wi-Fi Network Name: This shows the name of the Wi-Fi network that the DIR-505 is extending.

Extended Wi-Fi Network Name (SSID): You can choose whether to use the same Wi-Fi network name as the one the DIR-505 is extending, or to create a new one. If you create a new one, enter the name for your extended Wi-Fi network.

Channel Width: Select the appropriate channel width between **20MHz** or **Auto 20/40MHz** from the drop-down menu.

Visibility Status: This setting controls whether the router's wireless network name (SSID) will be broadcast so that wireless devices can scan for it. If you set it to **Invisible**, all wireless clients will need to enter the network name and security settings of your wireless network manually.

Security Mode: Select **None**, **WEP**, or **WPA-Personal**; the relevant settings for the security mode you choose will appear. For security purposes, it is highly recommended that you set this to WPA-Personal. For more details, refer to the previous page.

Wi-Fi Protected Setup: Wi-Fi Protected Setup, or WCN, allows you to configure the basic settings of the DIR-505 through Windows. To enable this feature, check the **Enable** checkbox.

D-Link

DIR-505 Repeater

SETUP WIZARD

SETUP ADVANCED MAINTENANCE STATUS HELP

EXTEND WI-FI

Use this section to configure the wireless LAN settings for your D-Link Router. You can create a new Wi-Fi Network Name (SSID) for your Local Wi-Fi Network (WLAN) or use the same Wi-Fi Network Name (SSID) as the joined Wi-Fi HotSpot for your local Wi-Fi Network (WLAN). Please note that changes made on this section will also need to be duplicated to your wireless clients and PC.

Save Settings Don't Save Settings

EXTEND WI-FI NETWORK SETTINGS

Wi-Fi Network Name : Qqqqqqqqqq

Extended Wi-Fi Network Name (SSID) : Same as Wi-Fi Network Name Create a new Wi-Fi Network Name

MobileCompanion-Claire

Channel Width : Auto 20/40 MHz

Visibility Status : Visible Invisible

WI-FI SECURITY MODE

Security Mode : WPA-Personal

WPA

Use **WPA** or **WPA2** mode to achieve a balance of strong security and best compatibility. This mode uses WPA for legacy clients while maintaining higher security with stations that are WPA2 capable. Also the strongest cipher that the client supports will be used. For best security, use **WPA2 Only** mode. This mode uses AES(CCM) cipher and legacy stations are not allowed access with WPA security. For maximum compatibility, use **WPA Only**. This mode uses TKIP cipher. Some gaming and legacy devices work only in this mode.

To achieve better wireless performance use WPA2 Only security mode (or in other words AES cipher).

WPA Mode : Auto (WPA or WPA2)

Cipher Type : TKIP and AES

PRE-SHARED KEY

Enter an 8 to 63 character alphanumeric pass-phrase. For good security it should be of ample length and should not be a commonly known phrase.

Pre-Shared Key :

WIFI PROTECTED SETUP (ALSO CALLED WCN 2.0 IN WINDOWS VISTA)

Enable :

Process WPS

WIRELESS

Helpful Hints...

You can choose to change the Extended Wi-Fi Network Name (SSID) and the Password for the DIR-505 or you can enter the information found in your Wi-Fi Configuration Card. In order for your Wi-Fi devices to connect to your DIR-505, you will need to manually enter the Wi-Fi Network Name and Password on each device.

LAN Setup

This section will allow you to change the local network settings of the DIR-505. After making your changes, click the **Save Settings** button.

Device Name: Enter the Device Name of the DIR-505. It is recommended that you change the Device Name if there is more than one D-Link device in your subnet.

LAN Connection Type: Use the drop-down menu to select the LAN Connection Type to use.

Type:

Select Dynamic IP (DHCP) to automatically obtain an IP address on the LAN/private network.

Select Static IP Address if all the Internet port's IP information is provided to you by your ISP.

If you choose DHCP as your connection type:

IP Address: Enter the IP address of the access point. The default IP address is 192.168.0.1. If you change the IP address, once you click **Apply**, you will need to enter the new IP address in your browser to get back into the configuration utility.

Subnet Mask: Enter the Subnet Mask assigned by your ISP.

Gateway Address: Enter the Gateway assigned by your ISP.

The screenshot shows the D-Link DIR-505 Repeater web interface. The main navigation bar includes 'D-Link', 'DIR-505 Repeater', and tabs for 'SETUP', 'ADVANCED', 'MAINTENANCE', 'STATUS', and 'HELP'. The 'LAN SETUP' section is selected, displaying 'NETWORK SETTINGS'. The 'DEVICE NAME' field is set to 'dlinkrouter'. The 'LAN IPV4 CONNECTION TYPE' is set to 'Dynamic IP (DHCP)'. The 'DYNAMIC IP(DHCP) LAN IPV4 CONNECTION TYPE' section shows the following values: IP Address: 192.168.0.1, Subnet Mask: 255.255.255.0, Gateway Address: 0.0.0.0, Primary DNS Server: 0.0.0.0, and Secondary DNS Server: 0.0.0.0. A 'WIRELESS' section is visible at the bottom left.

If you choose Static IP as your connection type:

IP Address: Enter the IP address the DIR-505 should use. The default IP address is 192.168.0.1. If you change the IP address, once you click **Apply**, you will need to enter the new IP address in your browser to get back into the configuration utility.

Subnet Mask: Enter the Subnet Mask assigned by your ISP.

Gateway Address: Enter the Gateway assigned by your ISP.

Primary DNS Server: Enter the Primary DNS Server's IP address assigned by your ISP.

Secondary DNS Server: Enter the Secondary DNS Server's IP address assigned by your ISP.

LAN IPV4 CONNECTION TYPE

Choose the IPv4 mode to be used by the Repeater.

My LAN Connection is :

STATIC IP ADDRESS LAN IPV4 CONNECTION TYPE

Enter the static address Information.

IP Address :

Subnet Mask :

Gateway Address :

Primary DNS Server :

Secondary DNS Server :

Advanced Advanced Wireless

This screen allows you to set various advanced wireless settings of your DIR-505. Unless you are experiencing specific problems, it is recommended that you leave these settings at their default values. After making your changes, click the **Save Settings** button.

Transmit Power: Sets the transmit power of the antennas.

HT 20/40 Coexistence: Check to enable or disable this feature.

The screenshot displays the D-Link DIR-505 Repeater web interface. The top navigation bar includes 'D-Link', 'DIR-505 Repeater', and tabs for 'SETUP', 'ADVANCED', 'MAINTENANCE', 'STATUS', and 'HELP'. The 'ADVANCED' tab is selected, showing the 'ADVANCED WIRELESS' settings page. A warning message states: 'These options are for users that wish to change the behaviour of their 802.11n wireless radio from the standard setting. D-Link does not recommend changing these settings from the factory default. Incorrect settings may impair the performance of your wireless radio. The default settings should provide the best wireless radio performance in most environments.' Below the warning are 'Save Settings' and 'Don't Save Settings' buttons. The 'ADVANCED WIRELESS SETTINGS' section shows 'Transmit Power' set to 100% and 'HT20/40 Coexistence' set to 'Enable'. A 'Helpful Hints...' sidebar on the right provides additional information about the 'Advanced Wireless' settings and the 'Transmit Power' dropdown menu.

ADVANCED WIRELESS

These options are for users that wish to change the behaviour of their 802.11n wireless radio from the standard setting. D-Link does not recommend changing these settings from the factory default. Incorrect settings may impair the performance of your wireless radio. The default settings should provide the best wireless radio performance in most environments.

Save Settings Don't Save Settings

ADVANCED WIRELESS SETTINGS

Transmit Power : 100% ▾

HT20/40 Coexistence : Enable Disable

Helpful Hints...

Advanced Wireless: It is recommended that you leave these options at their default values. Adjusting them could negatively impact the performance of your wireless network. The options on this page should be changed by advanced users or if you are instructed to by one of our support personnel, as they can negatively affect the performance of your Repeater if configured improperly.

Transmit Power: You can lower the output power of the DIR-505 by selecting lower percentage Transmit Power values from the drop down. Your choices are: 100%, 75%, 50%, and 25%.

WIRELESS

Copyright © 2012 D-Link Corporation/D-Link Systems, Inc.

Wi-Fi Protected Setup

Wi-Fi Protected Setup (WPS) System is a simplified way to set up the basic settings of the DIR-505. It can also be used to automatically create a secure wireless connection to a wireless client. After making your changes, click the **Save Settings** button.

Enable: Check this box to enable the WPS functions of the DIR-505.

Disable WPS PIN Method: Disabling this will disable the WPS PIN method of connection and configuration. If you want to reconfigure the router using the WPS PIN method, click on the **Reset to Unconfigured** button. You will still be able to add wireless clients through WPS.

PIN Settings: Shows the router's current PIN. You can reset it to the default value by clicking on the **Reset PIN to Default** button, or you can create a new PIN number by clicking on the **Generate New PIN** button.

Add Wireless Station: Here, you can click on the **Add Wireless Device With WPS** button to go through a wizard that helps you connect other devices through WPS.

The screenshot shows the D-Link DIR-505 Repeater configuration interface. The top navigation bar includes 'D-Link', 'DIR-505 Repeater', and tabs for 'SETUP', 'ADVANCED', 'MAINTENANCE', 'STATUS', and 'HELP'. The 'ADVANCED WIRELESS' section is active, showing 'WI-FI PROTECTED SETUP'.

WI-FI PROTECTED SETUP

Wi-Fi Protected Setup is used to easily add devices to a network using a PIN or button press. Devices must support Wi-Fi Protected Setup in order to be configured by this method. If the PIN changes, the new PIN will be used in following Wi-Fi Protected Setup process. Clicking on "Don't Save Settings" button will not reset the PIN. However, if the new PIN is not saved, it will get lost when the device reboots or loses power.

Buttons: Save Settings, Don't Save Settings

WI-FI PROTECTED SETUP

Enable :

Disable WPS-PIN Method :

Reset to Unconfigured

PIN SETTINGS

Current PIN: 30280304

Buttons: Reset PIN to Default, Generate New PIN

ADD WIRELESS STATION

Add Wireless Device With WPS

WIRELESS

Copyright © 2012 D-Link Corporation/D-Link Systems, Inc.

Helpful Hints...

Enable if other wireless devices you wish to include in the local network support Wi-Fi Protected Setup.

Click **Add Wireless Device Wizard** to use Wi-Fi Protected Setup to add wireless devices to the wireless network.

Maintenance Admin

This page will allow you to change the password for the administrator account for configuring the settings of the DIR-505. You can also turn on graphical authentication(CAPTCHA) on this page. After making your changes, click the **Save Settings** button.

Password: Enter a new password for the Administrator Login Name. The administrator can make changes to the settings.

Verify Password: Enter the same password that you entered in the previous textbox in order to confirm its accuracy.

Enable Graphical Authentication: Check to enable Graphical Authentication, or CAPTCHAs when logging in to the web UI of the DIR-505. This provides an extra layer of security by requiring you to enter a code that is displayed on-screen.

The screenshot shows the D-Link web interface for the DIR-505 Repeater. The top navigation bar includes 'D-Link', 'DIR-505 // Repeater', and tabs for 'SETUP', 'ADVANCED', 'MAINTENANCE', 'STATUS', and 'HELP'. The 'MAINTENANCE' tab is active, displaying the 'ADMINISTRATOR SETTINGS' section. This section contains instructions for changing the password, a 'PASSWORD' section with 'New Password' and 'Verify Password' input fields, and an 'ADMINISTRATION' section with an 'Enable Graphical Authentication' checkbox. A 'Helpful Hints...' sidebar on the right provides security advice. The footer includes 'WIRELESS' and 'Copyright © 2012 D-Link Corporation/D-Link Systems, Inc.'

System

This page allows you to save and restore your configuration, reset and reboot the DIR-505, and remove any added language packs.

Save Settings To Local Hard Drive: Clicking the **Save** button will allow you to save the current repeater configuration settings to a file on the hard disk of the computer you are using. You will then see a file dialog where you can select a location and file name for the settings.

Load Settings From Local Hard Drive: Use this option to load previously saved configuration settings. Click **Browse** to find a previously saved configuration file. Then, click the **Upload Settings** button to transfer those settings to the DIR-505.

Restore to Factory Default Settings: This option will restore all configuration settings back to the factory default settings. Any settings that have not been saved will be lost, including any rules that you have created. If you want to save your current configuration settings, use the **Save** button above.

Note: Restoring the factory default settings will not reset the Wi-Fi Protected Status to Not Configured.

Reboot the Device: Click the **Reboot** button to reboot the repeater.

Remove Language Pack: If you have previously installed a Language Pack, you can remove it by clicking the Remove button.

The screenshot shows the D-Link DIR-505 Repeater web interface. The top navigation bar includes 'D-Link', 'DIR-505 Repeater', and tabs for 'SETUP', 'ADVANCED', 'MAINTENANCE', 'STATUS', and 'HELP'. The left sidebar contains 'ADMIN', 'SYSTEM', 'FIRMWARE', and 'TIME'. The main content area is titled 'SAVE AND RESTORE' and contains the following text and controls:

The current system settings can be saved as a file onto the local hard drive. You can upload any save settings file that was created by the DIR-505.

SAVE AND RESTORE

Save Settings To Local Hard Drive :

Load Settings From Local Hard Drive :

Upload Settings

Restore Device

Restore To Factory Default Settings :

Reboot The Device :

Remove Language Pack :

Helpful Hints... **Saving System Settings:** Once your Repeater is configured the way you want it, you can save these settings to a configuration file that can later be loaded in the event that the Repeater's default settings are restored. To do this, click the Save button next to where it says Save Settings to Local Hard Drive.

WIRELESS

Copyright © 2012 D-Link Corporation/D-Link Systems, Inc.

Firmware

You can upgrade the firmware of the DIR-505 here. Make sure the firmware you want to use is on the local hard drive of the computer. Click on **Browse** to locate the firmware file to be used for the update. Please check the D-Link support website for firmware updates at <http://support.dlink.com>. You can download firmware upgrades to your hard drive from this site.

Firmware Upgrade: Click on **Check Now** to find out if there is an updated firmware; if so, download the new firmware to your hard drive.

After you have downloaded the new firmware, click **Browse** to locate the firmware update on your hard drive. Click **Upload** to complete the firmware upgrade. Do not disconnect from the DIR-505 or power your computer or DIR-505 off during the upgrade process.

You can change the language of the web UI by uploading available language packs.

Browse: Download a language pack from the D-Link website. After you have downloaded the new language pack, click **Browse** to locate the language pack file on your hard drive. Click **Upload** to complete the language pack upgrade.

The screenshot shows the D-Link DIR-505 Repeater web interface. The top navigation bar includes 'DIR-505 // Repeater', 'SETUP', 'ADVANCED', 'MAINTENANCE', 'STATUS', and 'HELP'. The left sidebar contains 'ADMIN', 'SYSTEM', 'FIRMWARE', and 'TIME'. The main content area is titled 'FIRMWARE' and contains the following sections:

- FIRMWARE:** A message stating: "There may be new firmware for your DIR-505 to improve functionality and performance. [Click here to check for an upgrade on our support site.](#) After you have downloaded the new firmware file from our support site, click the Browse button below to find the firmware file on your local hard drive. Click the Upload button to update the firmware on the DIR-505. **Do not update firmware through wireless network!!**"
- FIRMWARE AND LANGUAGE PACK INFORMATION:** Shows "Current Firmware Version : 1.05" and "Date : 2012/9/19". It also shows "Current Language Pack Version : No Language pack" and a "Check Online Now for Latest Firmware and Language pack Version :
- FIRMWARE UPGRADE:** Includes a note: "Note: Some firmware upgrades reset the configuration options to the factory defaults. Before performing an upgrade, be sure to save the current configuration from the [Maintenance](#) - [System](#) screen". Below this, it says: "To upgrade the firmware, your PC must have a wired connection to the Repeater. Enter the name of the firmware upgrade file, and click on the Upload button." There is an "Upload" field with a "Browse..." button and an "Upload" button.
- LANGUAGE PACK UPGRADE:** Similar to the firmware upgrade section, it has an "Upload" field with a "Browse..." button and an "Upload" button.

On the right side, there is a "Helpful Hints..." section titled "Firmware Updates:" which states: "Firmware updates are released periodically to improve the functionality of your Repeater and also to add features. If you run into a problem with a specific feature of the Repeater, check our support site by clicking on the [Click here to check for an upgrade on our support site](#) link and see if an updated firmware is available for your Repeater."

The bottom of the page has a "WIRELESS" tab.

Time

The Time page allows you to configure, update, and maintain the correct time on the internal system clock. From this section you can set the time zone that you are in. Daylight Saving can also be configured to automatically adjust the time when needed. After making your changes, click the **Save Settings** button.

Time Zone: Select the Time Zone from the drop-down menu.

Enable Daylight Saving: To select Daylight Saving time manually, click the **Enable Daylight Saving** check box. Next use the drop-down menu to select a **Daylight Saving Offset** and then enter a start date and an end date for daylight saving time.

Enable NTP Server: NTP is short for Network Time Protocol. NTP synchronizes computer clock times in a network of computers. Check this box to use a NTP server. This will only connect to a server on the Internet, not a local server.

NTP Server Used: Enter the NTP server or select one from the drop-down menu.

Date and Time: To manually input the time, enter the values in these fields for the Year, Month, Day, Hour, Minute, and Second and then click **Save Settings**. You can also click the **Copy Your Computer's Time Settings** button at the bottom of the screen.

D-Link

DIR-505 Repeater

ADMIN SETUP ADVANCED MAINTENANCE STATUS HELP

TIME

The Time Configuration option allows you to configure, update, and maintain the correct time on the internal system clock. From this section you can set the time zone that you are in and set the NTP (Network Time Protocol) Server. Daylight Saving can also be configured to automatically adjust the time when needed.

Save Settings Don't Save Settings

TIME CONFIGURATION

Current Time : Jan/01/2011 00:05:29

Time Zone : (GMT-08:00) Pacific Time (US/Canada), Tijuana

Enable Daylight Saving :

Daylight Saving Offset : +1:00

Daylight Saving Dates :

DST start	Month	Week	Day of Week	Time
Mar	3rd	Sun	1 am	
Nov	2nd	Sun	1 am	

AUTOMATIC TIME CONFIGURATION

Enable NTP Server :

NTP Server Used : << Select NTP Server

SET THE DATE AND TIME MANUALLY

Date And Time : Year 2011 Month Jan Day 01

Hour 00 Minute 00 Second 00

Copy Your Computer's Time Settings

WIRELESS

Copyright © 2012 D-Link Corporation/D-Link Systems, Inc.

Helpful Hints...

System Time Settings: This section allows admins to configure, update, and maintain the correct time on the Repeater's internal system clock.

Status

Device Info

This page displays the current information for the DIR-505. It will display the LAN and wireless LAN information.

General: Displays the time and firmware version.

Wi-Fi Network: Displays information about the Wi-Fi network and connection that the DIR-505 is extending.

Extended Wi-Fi Network: Displays information about the extended Wi-Fi network created by the DIR-505.

D-Link

DIR-505 Repeater SETUP ADVANCED MAINTENANCE STATUS HELP

DEVICE INFORMATION

All of your wireless and network connection details are displayed on this page. The firmware version is also displayed here.

Helpful Hints...
All of your LAN and Wireless connection details are displayed here.

GENERAL

Time : Jan/01/2011 00:20:53
Firmware Version : 1.05, Thu, 04 Oct 2012

WI-FI NETWORK

Network Status : Disconnected
MAC Address : 2a:10:7b:c1:e7:74
Network Name (SSID) : dlink
Security Mode : Disable
Channel Width : Auto 20/40 MHz
Channel : 1

EXTENDED WI-FI NETWORK

MAC Address : 28:10:7b:c1:e7:74
Extended Wi-Fi Network Name (SSID) : MobileCompanion-Claire-3
Connection : DHCP
IP Address : 192.168.0.1
Subnet Mask : 255.255.255.0
Gateway Address : 0.0.0.0
Primary DNS Server : 0.0.0.0
Secondary DNS Server : 0.0.0.0

WIRELESS

Logs

The DIR-505 keeps a running log of events and activities occurring on the DIR-505. If the DIR-505 is rebooted, the logs are automatically cleared.

Log Options: There are several types of logs that can be viewed: **System Activity, Debug Information, Attacks, Dropped Packets** and **Notice**.

First Page: This button directs you to the first page of the log.

Last Page: This button directs you to the last page of the log.

Previous: This button directs you to the previous page of the log.

Next: This button directs you to the next page of the log.

Clear: This button clears all current log content.

Save Log: This button opens dialog where you can save the current log to your hard drive.

Refresh: This button refreshes the log.

D-Link

DIR-505 // Repeater SETUP ADVANCED MAINTENANCE STATUS HELP

DEVICE INFO LOGS STATISTICS Helpful Hints...

Use this option to view the device logs. You can define what types of events you want to view and the event levels to view.

LOG OPTIONS

Log Type : System Activity Debug Information Attacks
 Dropped Packets Notice

Apply Log Settings Now

LOG DETAILS

First Page Last Page Previous Next Clear Save Log

Refresh

1/7

Time	Message
Jan 1 00:05:07	Registering new address record for 192.168.0.1 on br0. IPv4.
Jan 1 00:05:07	Registering new address record for 192.168.0.1 on br0. IPv4.
Jan 1 00:05:07	New relevant interface br0.Ipv4 for mDNS.
Jan 1 00:05:07	Joining mDNS multicast group on interface br0.Ipv4 with address 192.168.0.1.
Jan 1 00:05:01	Sending discover...
Jan 1 00:05:00	DHCP client start.
Jan 1 00:04:59	Interface br0.Ipv4 no longer relevant for mDNS.
Jan 1 00:04:59	Leaving mDNS multicast group on interface br0.Ipv4 with address 192.168.0.101.
Jan 1 00:04:59	Withdrawing address record for 192.168.0.101 on br0.
Jan 1 00:04:59	Withdrawing address record for 192.168.0.101 on br0.

WIRELESS

Copyright © 2012 D-Link Corporation/D-Link Systems, Inc.

Statistics

The DIR-505 keeps statistics of the traffic that passes through it. You can view the amount of packets that pass through the LAN and wireless portions of the network. Click the **Refresh Statistics** button to update the information, or click the **Clear Statistics** button to reset all statistics. The traffic counter will reset if the DIR-505 is rebooted.

D-Link

DIR-505 // Repeater

SETUP ADVANCED MAINTENANCE STATUS HELP

DEVICE INFO

LOGS

STATISTICS

TRAFFIC STATISTICS

Traffic Statistics display Receive and Transmit packets passing through your router.

Refresh Statistics Clear Statistics

LAN STATISTICS

Sent : 5707	Received : 3433
TX Packets Dropped : 0	RX Packets Dropped : 0
Collisions : 0	Errors : 0

WIRELESS STATISTICS

Sent : 290	Received : 0
TX Packets Dropped : 620	RX Packets Dropped : 0
Collisions : 0	Errors : 0

Helpful Hints...

This is a summary of the number of packets that have passed between the Wireless and the LAN since the device was last initialized.

WIRELESS

Copyright © 2012 D-Link Corporation/D-Link Systems, Inc.

Help

This screen gives you more information about the various parts of the configuration interface. Click on a link to learn more about that topic.

The screenshot displays the D-Link DIR-505 Repeater configuration interface. At the top, the D-Link logo is visible. Below it, a navigation bar contains tabs for SETUP, ADVANCED, MAINTENANCE, STATUS, and HELP. The HELP tab is selected, and the main content area shows a 'HELP MENU' with the following sections:

- Setup**
 - [Setup Wizard](#)
 - [Wireless Setup](#)
 - [Lan Setup](#)
- Advanced**
 - [Advanced Wireless](#)
- Maintenance**
 - [Admin](#)
 - [System](#)
 - [Firmware](#)
 - [Time](#)
- Status**
 - [Device Info](#)
 - [Logs](#)
 - [Statistics](#)

To the right of the menu, a 'Helpful Hints...' section contains the text: 'Click on the links for more informations of each section in the GUI.'

At the bottom of the interface, the word 'WIRELESS' is displayed in a dark bar, and a copyright notice reads: 'Copyright © 2012 D-Link Corporation/D-Link Systems, Inc.'

Wi-Fi Hot Spot Mode

This section describes the configuration interface for Wi-Fi Hot Spot mode. Make sure that the mode selector switch is in the Wi-Fi Hot Spot position on your DIR-505.

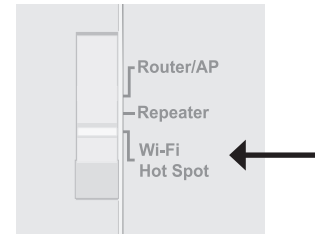

Setup Quick Setup Wizard

If this is your first time using this device, you will be directed to the Pre-Setup Wizard. If you have already completed the Pre-Setup Wizard, please continue to page 116.

Enter **Admin** in the User Name field. Leave the password blank by default.

Click **Next** to continue.

Please wait while your device scans for an available Wi-Fi Network.

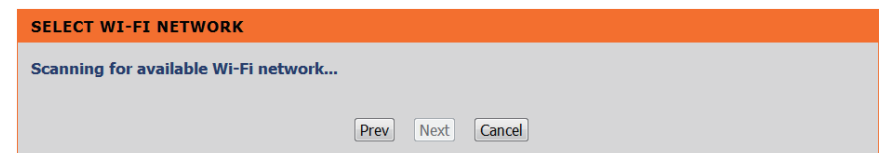
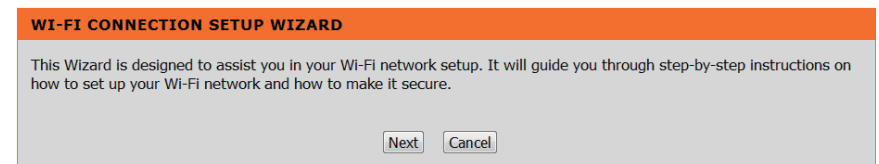
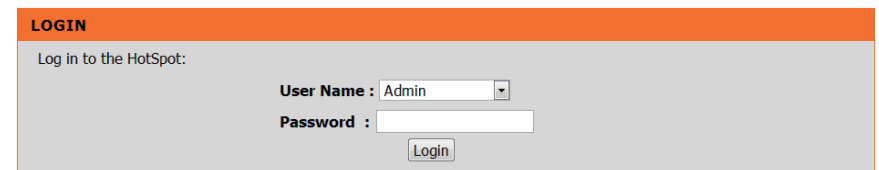

Select the Network you would like your device to connect to and click **Connect**.

ID	Wi-Fi Network Name	Encrypt	Channel	Signal(%)	Select
1	DHP-W306AV	WPA/WPA2-PSK(auto)	8	94	<input type="radio"/>
2	dlink_DHP-1565	WPA/WPA2-PSK(auto)	6	94	<input type="radio"/>
3	LoudFish	WPA/WPA2-PSK(auto)	11	94	<input type="radio"/>
4	LoudFish-guest	None	11	94	<input type="radio"/>
5	irvine2	WPA/WPA2-PSK(auto)	6	82	<input type="radio"/>
6	ATT720	WPA/WPA2-PSK(auto)	1	3	<input type="radio"/>

Rescan Connect Cancel

Enter the Wi-Fi password and click **Next** to continue.

ENTER WI-FI PASSWORD

Please enter Wi-Fi Password to establish wireless connection

Wi-Fi Password:

Prev Next Cancel

Select **Use the same Wi-Fi Network name for the extended Network** and click **Next**.

If you want to use a different wireless network name and password, untick the checkbox and enter the network name and password you want to use.

PLEASE ENTER THE SETTINGS FOR THE EXTENDER NETWORK

Use the same Wi-Fi Network Name for the Extended Network

Give your Extended Wi-Fi network a name.

Extended Wi-Fi Network Name (SSID):
 (Using up to 32 characters)

Give your Extended Wi-Fi network a password.

Wi-Fi Password:
 (Between 8 and 63 characters)

Prev Next Cancel

Your setup is now complete. Click **Save** to finish.

SETUP COMPLETE!

Please take a note of the following summary of your Wi-Fi Security settings for future reference.

Wi-Fi Network Name (SSID): D-Link

Extended Wi-Fi Network Name (SSID): MobileCompanion-Claire

Wi-Fi Password: 0509duck

The Setup Wizard has completed. Click the Save button to save your settings and reboot the device.

Prev Save Cancel

Wi-Fi Hotspot Setup

The Wi-Fi Hotspot Setup page allows you to enter the settings of the Wi-Fi hotspot that the DIR-505 will connect to and share access to. Please note that this is different from the wireless network created by the DIR-505 that you will connect your devices to. After making your changes, click the **Save Settings** button.

Wireless Mode: This will state **Wi-Fi Hot Spot Mode** when in Wi-Fi Hot Spot Mode. You can click the **Site Survey** button to look for available hotspots to connect to. Selecting a wireless network from the list that appears will automatically fill in the settings below.

Wi-Fi HotSpot Network Name: Enter the name of the Wi-Fi hotspot wireless network you want to connect the DIR-505 to. You can use the **Site Survey** button to fill this in automatically.

Channel Width: Select the appropriate channel width to use from the dropdown box. If you are not sure what to use, leave the setting on **Auto**.

Security Mode: Select the wireless encryption used by the Wi-Fi hotspot you are connecting to. You can use the **Site Survey** button to fill in most of the information automatically; you can then just enter the password(WEP Key or Pre-Shared Key) for the Wi-Fi hotspot.

D-Link

DIR-505 // HotSpot

SETUP ADVANCED MAINTENANCE STATUS HELP

SETUP WIZARD

WI-FI HOTSPOT SETUP

WIRELESS LAN SETUP

LAN SETUP

MEDIA SERVER

STORAGE

WI-FI HOTSPOT

Use this section to configure the Wi-Fi HotSpot settings for your D-Link Wi-Fi HotSpot. Please select a Wi-Fi HotSpot to join by click the Site Survey button and enter the password of the Wi-Fi HotSpot Network.

Save Settings Don't Save Settings

WI-FI HOTSPOT NETWORK SETTINGS

Wireless Mode : Wi-Fi HotSpot Mode Site Survey

Wi-Fi HotSpot Network Name : AirPort Express (Also called the SSID)

Channel Width : Auto 20/40 MHz

WI-FI HOTSPOT SECURITY MODE

Security Mode : WPA-Personal

WPA

Use **WPA** or **WPA2** mode to achieve a balance of strong security and best compatibility. This mode uses WPA for legacy clients while maintaining higher security with stations that are WPA2 capable. Also the strongest cipher that the client supports will be used. For best security, use **WPA2 Only** mode. This mode uses AES(CCMP) cipher and legacy stations are not allowed access with WPA security. For maximum compatibility, use **WPA Only**. This mode uses TKIP cipher. Some gaming and legacy devices work only in this mode.

To achieve better wireless performance use WPA2 Only security mode (or in other words AES cipher).

WPA Mode : WPA2 Only

Cipher Type : AES

INTERNET SETTINGS

This page is used to configure the parameters for Internet network which connects through the Wi-Fi HotSpot wirelessly. Here you may select the access method of DHCP in My Internet Connection Type.

My Internet Connection is : Dynamic IP (DHCP)

Host Name : DIR-505

MTU : 1500

Attain DNS Automatically

Set DNS Manually

MAC Address : 00:00:00:00:00:00

Clone Your PC's MAC address

WIFI PROTECTED SETUP (ALSO CALLED WCN 2.0 IN WINDOWS VISTA)

Enable :

Internet Settings Here, you can set the connection settings for the Wi-Fi hotspot. In most cases, you should not need to change any of the values from their default settings.

Wi-Fi Protected Setup: Tick this checkbox to enable connecting to a Wi-Fi hotspot through WPS. To use WPS to connect, click the **Process WPS** button, then press the WPS button on the Wi-Fi hotspot's router.

The image shows two screenshots of a router's web interface. The top screenshot is titled "INTERNET SETTINGS" and contains the following text and controls: "This page is used to configure the parameters for Internet network which connects through the Wi-Fi HotSpot wirelessly. Here you may select the access method of DHCP in My Internet Connection Type." Below this, there are several fields: "My Internet Connection is :" with a dropdown menu set to "Dynamic IP (DHCP)", "Host Name :" with a text box containing "DIR-505", "MTU :" with a text box containing "1500", and "MAC Address :" with a text box containing "00:00:00:00:00:00". There are two radio buttons for DNS settings: "Attain DNS Automatically" (selected) and "Set DNS Manually". A button labeled "Clone Your PC's MAC address" is located below the MAC address field. The bottom screenshot is titled "WIFI PROTECTED SETUP (ALSO CALLED WCN 2.0 IN WINDOWS VISTA)" and shows an "Enable :" checkbox which is checked, and a "Process WPS" button below it.

Wireless LAN Setup

Use this section to configure the Wireless LAN settings for your D-Link router. This will configure the wireless network you will connect to with your PCs and devices. You can create a new Wi-Fi network name (SSID) for your local Wi-Fi network (WLAN), or use the same wireless network name (SSID) as the Wi-Fi hotspot the router is connecting to. After making your changes, click the **Save Settings** button.

Local Wi-Fi Network Set whether you want to use the same network name as the Wi-Fi hotspot the router is connected to (**Same as Wi-Fi Network Name: HotSpot Network Name**), or if you want to create a new network name to use (**Create a new Wi-Fi Network Name**).

Channel Width: Select whether to use **Auto 20/40 MHz** or **20 MHz** for the channel width. Normally, this should be left on **Auto 20/40 MHz**. If you are not using any 802.11n wireless clients, you can set this to **20 MHz**.

Visibility Status: This setting controls whether the router's wireless network name (SSID) will be broadcast so that wireless devices can scan for it. If you set it to **Invisible**, all wireless clients will need to enter the network name and security settings of your wireless network manually.

Security Mode: Select from the drop-down menu the type of security mode you would like to use.

WPA Mode: Select **Auto**, **WPA2 Only**, or **WPA Only**. Use **Auto** if you have wireless clients using both WPA and WPA2.

Cipher Type: Select **TKIP and AES**, **TKIP**, or **AES**.

D-Link

DIR-505 // HotSpot

SETUP ADVANCED MAINTENANCE STATUS HELP

SETUP WIZARD

WI-FI HOTSPOT SETUP

WIRELESS LAN SETUP

LAN SETUP

MEDIA SERVER

STORAGE

WIRELESS LAN

Use this section to configure the wireless LAN settings for your D-Link Router. You can create a new Wi-Fi Network Name (SSID) for your Local Wi-Fi Network (WLAN) or use the same Wi-Fi Network Name (SSID) as the Joined Wi-Fi HotSpot for your local Wi-Fi Network (WLAN). Please note that changes made on this section will also need to be duplicated to your wireless clients and PC.

Save Settings Don't Save Settings

LOCAL WI-FI NETWORK SETTINGS

Wi-Fi HotSpot Network Name : dlink

Local Wi-Fi Network Name : Same as Wi-Fi HotSpot Network Name Create a new Wi-Fi Network Name

dlink-708a

Channel Width : Auto 20/40 MHz

Visibility Status : Visible Invisible

LOCAL WI-FI SECURITY MODE

Security Mode : WPA-Personal

WPA

Use **WPA** or **WPA2** mode to achieve a balance of strong security and best compatibility. This mode uses WPA for legacy clients while maintaining higher security with stations that are WPA2 capable. Also the strongest cipher that the client supports will be used. For best security, use **WPA2 Only** mode. This mode uses AES (CCMP) cipher and legacy stations are not allowed access with WPA security. For maximum compatibility, use **WPA Only**. This mode uses TKIP cipher. Some gaming and legacy devices work only in this mode.

To achieve better wireless performance use WPA2 Only security mode (or in other words AES cipher).

WPA Mode : Auto (WPA or WPA2)

Cipher Type : TKIP and AES

PRE-SHARED KEY

Enter an 8 to 63 character alphanumeric pass-phrase. For good security it should be of ample length and should not be a commonly known phrase.

Pre-Shared Key :

WIFI PROTECTED SETUP (ALSO CALLED WCN 2.0 IN WINDOWS VISTA)

Enable :

Helpful Hints...

Changing your Wireless Network Name is the first step in securing your wireless network. Change it to a familiar name that does not contain any personal information.

Enable Auto Channel Scan so that the Access Point can select the best possible channel for your wireless network to operate on.

Visibility Status is another way to secure your network. With invisible option enabled, no wireless clients will be able to see your wireless network when they perform scan to see what's available. In order for your wireless devices to connect to your AP, you will need to manually enter the Wireless Network Name on each device.

If you have enabled Wireless Security, make sure you write down the Key or Passphrase that you have configured. You will need to enter this information on any wireless device that you connect to your wireless network.

Pre-Shared Key: Enter a password to use for your wireless network.

Wi-Fi Protected Setup: Tick the Enable checkbox to enable use of WPS for wireless clients. You can then click the **Process WPS** button and the press the WPS button on your client to set up a connection.

The screenshot displays two sections of a configuration interface. The top section, titled "PRE-SHARED KEY", contains a text box with the instruction: "Enter an 8 to 63 character alphanumeric pass-phrase. For good security it should be of ample length and should not be a commonly known phrase." Below this is a label "Pre-Shared Key :" followed by a text input field containing seven black dots. The bottom section, titled "WIFI PROTECTED SETUP (ALSO CALLED WCN 2.0 IN WINDOWS VISTA)", features a label "Enable :" next to a checked checkbox. Below the checkbox is a button labeled "Process WPS".

LAN Setup

This section will allow you to change the local network settings of the DIR-505 and to configure the DHCP settings. After making your changes, click the **Save Settings** button.

Device Name: Enter the Device Name of the DIR-505. It is recommended that you change the Device Name if there is more than one D-Link device in your subnet.

Dynamic IP (DHCP) LAN Connection Type: Here, you can edit the **IP Address**, **Subnet Mask**, and **Local Domain Name** for the DIR-505 to use.

DHCP Server Settings: Ticking the **Enable DHCP Server** checkbox allows the DIR-505 to assign IP addresses to the devices on your network. by using DHCP. You can set the range of allowable IP addresses using the **DHCP IP Address Range** text boxes, and you can set the **DHCP Lease Time** with the corresponding text box.

D-Link

DIR-505 // HotSpot

SETUP ADVANCED MAINTENANCE STATUS HELP

SETUP WIZARD

WIFI HOTSPOT SETUP

WIRELESS LAN SETUP

LAN SETUP

MEDIA SERVER

STORAGE

NETWORK SETTINGS

Use this section to configure the internal network settings of your AP.

Device Name allows you to configure this device more easily when your network using TCP/IP protocol. You can enter the device name of the AP into your web browser to access the instead of IP address for configuration. Recommend to change the device name if there're more than one D-Link devices within the subnet.

Save Settings Don't Save Settings

DEVICE NAME

Device Name allows you to configure this device more easily. You can enter "http://"device name" into your web browser instead of IP address for configuration. (Default: http://dlinkrouter)

Device Name : dlinkrouter

STATIC IP ADDRESS LAN CONNECTION TYPE

Enter the static address information.

IP Address : 192.168.100.1

Subnet Mask : 255.255.255.0

Local Domain Name :

DHCP SERVER SETTINGS

Use this section to configure the built-in DHCP Server to assign IP addresses to the computers on your network.

Enable DHCP Server :

DHCP IP Address Range : 192.168.100.100 to 192.168.100.199

DHCP Lease Time : 1440 (minutes)

Helpful Hints...

Device Name: Device Name allows you to configure this device more easily when your network using TCP/IP protocol. You can enter the device name of the AP into your web browser to access the device configuration. Recommend to change the device name if there're more than one D-Link devices within the network.

LAN Settings: Also referred as private settings. LAN settings allow you to configure LAN interface of DIR-505. LAN IP address is private to your internal network and is not visible to Internet. The factory default setting is Dynamic IP(DHCP).

WIRELESS

Media Server

This feature allows you to share music, pictures and videos with any devices connected to your network. After making your changes, click the **Save Settings** button.

Enable Media Server: Check this box to enable the media server feature.

Computer Name: Enter the media server's name.

The screenshot shows the D-Link DIR-505 HotSpot configuration interface. The top navigation bar includes 'D-Link', 'DIR-505 // HotSpot', 'SETUP', 'ADVANCED', 'MAINTENANCE', 'STATUS', and 'HELP'. The left sidebar lists 'SETUP WIZARD', 'WI-FI HOTSPOT SETUP', 'WIRELESS LAN SETUP', 'LAN SETUP', 'MEDIA SERVER', and 'STORAGE'. The main content area is titled 'MEDIA SERVER' and contains the following text: 'Enable DLNA Media Server allows you to share media with DLNA certified devices. Any DLNA certified devices that connect to your network can play your shared music, pictures, and videos.' Below this is a note: 'Note: The shared media may not be secure. Allowing any devices to stream is recommended only on secure networks.' There are two buttons: 'Save Settings' and 'Don't Save Settings'. A section titled 'DLNA MEDIA SERVER' contains a checked checkbox for 'Enable DLNA Media Server' and a text input field for 'Media Server Name' with the value 'DIR-505'. The footer includes 'WIRELESS' and 'Copyright © 2012 D-Link Corporation/D-Link Systems, Inc.'

Storage

This page will allow you to access files from a USB external hard drive or thumb drive that is plugged into the DIR-505 from your local network or from the Internet using either a web browser or the SharePort Mobile app for your smartphone or tablet. You can create users to customize access rights to the files stored on the USB drive. After making your changes, click the **Save Settings** button.

Enable Shareport Web Access: Tick this checkbox to enable sharing files stored on a USB storage drive connected to the DIR-505.

HTTP Access Port: Enter a port to use for HTTP web access to your files (8181 is the default). You will have to add this port to the IP address of the DIR-505 when connecting. For example: `http://192.168.0.1:8181`

HTTPS Access Port: Enter a port to use for HTTPS secure access to your files (4433 is the default). You will have to add this port to the IP address of the DIR-505 when connecting. For example: `https://192.168.0.1:4433`

Allow Remote Access: Check to enable remote access to your router's storage.

User Name: To create a new user, enter a user name. To edit an existing user, use the dropdown box to the right.

Password/Verify Password: Enter a password you want to use for the account, re-enter the password in the **Verify Password** text box, then click **Add/Edit** to save your changes.

User List: This section shows existing user accounts. There are **admin** and **guest** accounts by default.

The screenshot shows the D-Link DIR-505 web interface. The top navigation bar includes 'DIR-505 // Hotspot', 'SETUP', 'ADVANCED', 'MAINTENANCE', 'STATUS', and 'HELP'. The 'STORAGE' section is active, displaying the following configuration options:

- SHAREPORT WEB ACCESS:**
 - Enable SharePort Web Access:
 - HTTP Access Port: 8181
 - HTTPS Access Port: 4433
 - Allow Remote Access:
- 10 -- USER CREATION:**
 - User Name: << User Name
 - Password:
 - Verify Password:
- USER LIST:**

No.	User Name	Access Path	Permission	
1	admin	/	Read/Write	
2	guest	None	Read Only	<input type="button" value="Edit"/>
- NUMBER OF DEVICES : 0**

Device	Total Space	Free Space
- SHAREPORT WEB ACCESS LINK:**

You can use this link to connect to the drive remotely after logging in with a user account.

Additional elements include a 'Helpful Hints...' sidebar on the right and a 'WIRELESS' footer at the bottom.

Number of Devices: This section shows you information about the USB storage device plugged into the router.

SharePort Web Access Link This will give you a direct link to the web access interface that you can click on or copy and paste.

NUMBER OF DEVICES : 0		
Device	Total Space	Free Space
SHAREPORT WEB ACCESS LINK		
You can use this link to connect to the drive remotely after logging in with a user account.		

Advanced MAC Address Filter

Use MAC (Media Access Control) Filters to control access to your network based on the MAC addresses of connected clients. You can set MAC address filtering to only allow the listed MAC addresses to connect, or block access to all listed MAC addresses. After making your changes, click the **Save Settings** button.

Note: Any wired devices connected to the Ethernet port on the DIR-505 will always have access to the network.

Wireless Access Settings: Configure how MAC filtering works by using the dropdown box to select an option:

Turn MAC Filtering OFF: This disables MAC filtering.

Turn MAC Filtering ON and ALLOW computers listed to access the network: When this option is selected, only PCs and devices with MAC addresses in the MAC Address List are granted network access. All other devices will be blocked.

Turn MAC Filtering ON and DENY computers listed to access the network: When this option is selected, all PCs and devices with MAC addresses in the MAC Address List will be refused access to your network. All other devices will be allowed access.

MAC Address: Enter the MAC addresses you would like to filter. You can select a client currently connected to your access point from the **Wireless Client List** drop-down menu and then click the corresponding << button fill in the MAC address automatically. Click the Clear button to remove any entered MAC address.

The screenshot displays the D-Link DIR-505 Advanced MAC Address Filter configuration interface. At the top, the D-Link logo is visible. The navigation menu includes 'DIR-505 // HotSpot', 'SETUP', 'ADVANCED', 'MAINTENANCE', 'STATUS', and 'HELP'. The 'MAC ADDRESS FILTER' section is active, showing a dropdown menu set to 'Turn MAC Filtering OFF'. Below this, the 'WIRELESS ACCESS SETTINGS' section contains a table with two columns: 'MAC Address' and 'Wireless Client List'. The table has eight rows, each with a MAC address field, a '<<' button, a dropdown menu labeled 'MAC Address', and a 'Clear' button. The footer of the page reads 'WIRELESS Copyright © 2012 D-Link Corporation/D-Link Systems, Inc.'

Advanced Wireless

This screen allows you to set various advanced wireless settings of your DIR-505. Unless you are experiencing specific problems, it is recommended that you leave these settings at their default values. After making your changes, click the **Save Settings** button.

Transmit Power: Sets the transmit power of the antennas.

HT 20/40 Coexistence: Check to enable or disable this feature.

D-Link

DIR-505 // HotSpot

SETUP **ADVANCED** MAINTENANCE STATUS HELP

MAC ADDRESS FILTER

ADVANCED WIRELESS

These options are for users that wish to change the behaviour of their 802.11n wireless radio from the standard setting. D-Link does not recommend changing these settings from the factory default. Incorrect settings may impair the performance of your wireless radio. The default settings should provide the best wireless radio performance in most environments.

Save Settings Don't Save Settings

ADVANCED WIRELESS SETTINGS

Transmit Power : 100% ▾

HT20/40 Coexistence : Enable Disable

Helpful Hints...

Advanced Wireless: It is recommended that you leave these options at their default values. Adjusting them could negatively impact the performance of your wireless network. The options on this page should be changed by advanced users or if you are instructed to by one of our support personnel, as they can negatively affect the performance of your Access Point if configured improperly.

Transmit Power: You can lower the output power of the DIR-505 by selecting lower percentage Transmit Power values from the drop down. Your choices are: 100%, 75%, 50%, and 25%.

WIRELESS

Copyright © 2012 D-Link Corporation/D-Link Systems, Inc.

Maintenance Admin

This page will allow you to change the password for the administrator account for configuring the settings of the DIR-505. You can also turn on graphical authentication(CAPTCHA) on this page. After making your changes, click the **Save Settings** button.

Password: Enter a new password for the Administrator Login Name. The administrator can make changes to the settings.

Verify Password: Enter the same password that you entered in the previous textbox in order to confirm its accuracy.

Enable Graphical Authentication: Check to enable Graphical Authentication, or CAPTCHAs when logging in to the web UI of the DIR-505. This provides an extra layer of security by requiring you to enter a code that is displayed on-screen.

D-Link

DIR-505 // HotSpot

SETUP ADVANCED **MAINTENANCE** STATUS HELP

ADMIN

TIME

SYSTEM

FIRMWARE

ADMINISTRATOR SETTINGS

Enter the new password in the "New Password" field and again in the next field to confirm. Click on "Save Settings" to execute the password change. The Password is case-sensitive, and can be made up of any keyboard characters. The new password must be between 0 and 15 characters in length.

Save Settings Don't Save Settings

PASSWORD

Please enter the same password into both boxes, for confirmation.

New Password : ●●●●●●

Verify Password : ●●●●●●

ADMINISTRATION

Enable Graphical Authentication :

Helpful Hints...
Passwords:
 For security reasons, it is recommended that you change the Password for the Administrator accounts. Be sure to write down the Passwords to avoid having to reset the AP in the event that they are forgotten.

WIRELESS

Time

The Time page allows you to configure, update, and maintain the correct time on the internal system clock. From this section you can set the time zone that you are in. Daylight Saving can also be configured to automatically adjust the time when needed. After making your changes, click the **Save Settings** button.

Time Zone: Select the Time Zone from the drop-down menu.

Enable Daylight Saving: To select Daylight Saving time manually, click the **Enable Daylight Saving** check box. Next use the drop-down menu to select a **Daylight Saving Offset** and then enter a start date and an end date for daylight saving time.

Enable NTP Server: NTP is short for Network Time Protocol. NTP synchronizes computer clock times in a network of computers. Check this box to use a NTP server. This will only connect to a server on the Internet, not a local server.

NTP Server Used: Enter the NTP server or select one from the drop-down menu.

Date and Time: To manually input the time, enter the values in these fields for the Year, Month, Day, Hour, Minute, and Second and then click **Save Settings**. You can also click the **Copy Your Computer's Time Settings** button at the bottom of the screen.

The screenshot displays the D-Link DIR-505 HotSpot configuration interface, specifically the 'TIME' section. The page is divided into several panels:

- TIME:** Contains an introductory text about time configuration and two buttons: 'Save Settings' and 'Don't Save Settings'.
- TIME CONFIGURATION:** Shows the current time as 'Jan/01/2011 00:07:11'. The time zone is set to '(GMT-08:00) Pacific Time (US/Canada), Tijuana'. There is an unchecked checkbox for 'Enable Daylight Saving' and a dropdown for 'Daylight Saving Offset' set to '+1:00'. Below this, 'Daylight Saving Dates' are configured with 'DST start' on 'Mar 3rd Sun 1 AM' and 'DST End' on 'Nov 2nd Sun 1 AM'.
- AUTOMATIC TIME CONFIGURATION:** Features an unchecked checkbox for 'Enable NTP Server' and a dropdown for 'NTP Server Used' with a '<< Select NTP Server' button.
- SET THE DATE AND TIME MANUALLY:** Provides fields for 'Date And Time' with dropdowns for Year (2011), Month (Jan), Day (01), Hour (00), Minute (00), and Second (00). A 'Copy Your Computer's Time Settings' button is located at the bottom.

The interface includes a navigation menu at the top with 'SETUP', 'ADVANCED', 'MAINTENANCE', 'STATUS', and 'HELP' tabs. A sidebar on the left lists 'ADMIN', 'TIME', 'SYSTEM', and 'FIRMWARE'. A 'Helpful Hints...' section on the right provides additional information about the 'System Time Settings'.

System

This page allows you to save and restore your configuration, reset and reboot the DIR-505, and remove any added language packs.

Save Settings To Local Hard Drive: Clicking the **Save** button will allow you to save the current repeater configuration settings to a file on the hard disk of the computer you are using. You will then see a file dialog where you can select a location and file name for the settings.

Load Settings From Local Hard Drive: Use this option to load previously saved configuration settings. Click **Browse** to find a previously saved configuration file. Then, click the **Upload Settings** button to transfer those settings to the DIR-505.

Restore to Factory Default Settings: This option will restore all configuration settings back to the factory default settings. Any settings that have not been saved will be lost, including any rules that you have created. If you want to save your current configuration settings, use the **Save** button above.

Note: Restoring the factory default settings will not reset the Wi-Fi Protected Status to Not Configured.

Reboot the Device: Click the **Reboot** button to reboot the repeater.

Remove Language Pack: If you have previously installed a Language Pack, you can remove it by clicking the Remove button.

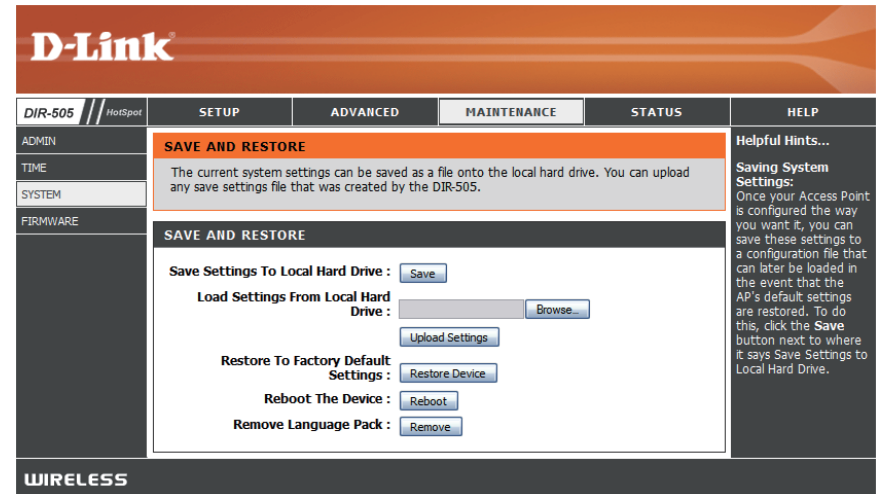

Firmware

You can upgrade the firmware of the DIR-505 here. Make sure the firmware you want to use is on the local hard drive of the computer. Click on **Browse** to locate the firmware file to be used for the update. Please check the D-Link support website for firmware updates at <http://support.dlink.com>. You can download firmware upgrades to your hard drive from this site.

Firmware Upgrade: Click on **Check Now** to find out if there is an updated firmware; if so, download the new firmware to your hard drive.

After you have downloaded the new firmware, click **Browse** to locate the firmware update on your hard drive. Click **Upload** to complete the firmware upgrade. Do not disconnect from the DIR-505 or power your computer or DIR-505 off during the upgrade process.

You can change the language of the web UI by uploading available language packs.

Browse: Download a language pack from the D-Link website. After you have downloaded the new language pack, click **Browse** to locate the language pack file on your hard drive. Click **Upload** to complete the language pack upgrade.

The screenshot shows the D-Link DIR-505 web interface. The top navigation bar includes 'DIR-505 // HotSpot', 'SETUP', 'ADVANCED', 'MAINTENANCE', 'STATUS', and 'HELP'. The 'MAINTENANCE' tab is selected, and the 'FIRMWARE' sub-tab is active. The main content area is titled 'FIRMWARE' and contains the following information:

- A notification: "There may be new firmware for your DIR-505 to improve functionality and performance. [Click here to check for an upgrade on our support site.](#) After you have download the new firmware file from our support site, click the Browse button below to find the firmware file on your local hard drive. Click the Upload button to update the firmware on the DIR-505. **Do not update firmware through wireless network!!**"
- FIRMWARE AND LANGUAGE PACK INFORMATION**
 - Current Firmware Version : 1.05 Date : 2012/9/19
 - Current Language Pack Version : No Language pack
 - Check Online Now for Latest Firmware and Language pack Version :
- FIRMWARE UPGRADE**
 - Note: Some firmware upgrades reset the configuration options to the factory defaults. Before performing an upgrade, be sure to save the current configuration from the [Maintenance](#) - [System](#) screen
 - To upgrade the firmware, your PC must have a wired connection to the access point. Enter the name of the firmware upgrade file, and click on the Upload button.
 - Upload :
- LANGUAGE PACK UPGRADE**
 - Upload :

The bottom of the page features a 'WIRELESS' section header.

Status

Device Info

This page displays the current information for the DIR-505. It will display the LAN and wireless LAN information.

General: Displays the time and firmware version.

Wi-Fi Hotspot Displays information about the connection to the Wi-Fi hotspot.

LAN: Displays the MAC address and the private (local) IP settings for the access point.

Wireless LAN: Displays the wireless MAC address and your wireless settings such as SSID and Channel.

The screenshot shows the D-Link DIR-505 web interface. The top navigation bar includes tabs for SETUP, ADVANCED, MAINTENANCE, STATUS, and HELP. The main content area is titled 'DEVICE INFORMATION' and contains the following sections:

- GENERAL:**
 - Time : Jan/01/2011 00:17:49
 - Firmware Version : 1.00, Thu, 9 Feb 2012
- WI-FI HOTSPOT:**
 - MAC Address : 00:18:e7:95:70:8b
 - Wi-Fi HotSpot Network Name (SSID) : dlink
 - Connection : DHCP
 - IP Address : 192.168.0.101
 - Subnet Mask : 255.255.255.0
 - Default Gateway : 0.0.0.0
 - Primary DNS Server : 192.168.0.1
 - Secondary DNS Server : 0.0.0.0
- LAN:**
 - MAC Address : 00:18:e7:95:70:8a
 - IP Address : 192.168.0.1
 - Subnet Mask : 255.255.255.0
 - DHCP Server : Enabled
- WIRELESS LAN:**
 - MAC Address : 02:18:e7:95:70:8b
 - Local Wi-Fi Network Name : dlink-708a
 - Local Wi-Fi Security Mode : Auto (WPA or WPA2) - Personal
 - Channel Width : Auto 20/40 MHz
 - Channel : 4
 - Wi-Fi Protected Setup : Enable / Configured

The bottom of the page features a 'WIRELESS' section header and a copyright notice: Copyright © 2012 D-Link Corporation/D-Link Systems, Inc.

Logs

The DIR-505 keeps a running log of events and activities occurring on the DIR-505. If the DIR-505 is rebooted, the logs are automatically cleared.

Log Options: There are several types of logs that can be viewed: **System Activity, Debug Information, Attacks, Dropped Packets** and **Notice**.

First Page: This button directs you to the first page of the log.

Last Page: This button directs you to the last page of the log.

Previous: This button directs you to the previous page of the log.

Next: This button directs you to the next page of the log.

Clear: This button clears all current log content.

Save Log: This button opens dialog where you can save the current log to your hard drive.

Refresh: This button refreshes the log.

D-Link

DIR-505 // HotSpot

SETUP ADVANCED MAINTENANCE STATUS HELP

DEVICE INFO LOGS STATISTICS

LOGS

Use this option to view the device logs. You can define what types of events you want to view and the event levels to view.

LOG OPTIONS

Log Type : System Activity Debug Information Attacks
 Dropped Packets Notice

Apply Log Settings Now

LOG DETAILS

First Page Last Page Previous Next Clear Save Log

Refresh

1/7

Time	Message
Jan 1 00:17:51	UDHCPD Inform: add_lease 192.168.0.100
Jan 1 00:16:45	UDHCPD Inform: add_lease 192.168.0.100
Jan 1 00:15:37	UDHCPD Inform: add_lease 192.168.0.100
Jan 1 00:14:26	UDHCPD Inform: add_lease 192.168.0.100
Jan 1 00:13:57	reading /etc/resolv.conf
Jan 1 00:13:46	Lease of 192.168.0.101 obtained, lease time 604800
Jan 1 00:13:41	Sending discover...
Jan 1 00:13:39	Sending discover...
Jan 1 00:13:25	Sending discover...
Jan 1 00:13:24	UDHCPD Inform: add_lease 192.168.0.100

Helpful Hints...
Check the log frequently to detect unauthorized network usage.

WIRELESS

Copyright © 2012 D-Link Corporation/D-Link Systems, Inc.

Statistics

The DIR-505 keeps statistics of the traffic that passes through it. You can view the amount of packets that pass through the LAN and wireless portions of the network. The traffic counter will reset if the DIR-505 is rebooted.

D-Link

DIR-505 // HotSpot

SETUP ADVANCED MAINTENANCE **STATUS** HELP

DEVICE INFO

LOGS

STATISTICS

TRAFFIC STATISTICS

Traffic Statistics display Receive and Transmit packets passing through your router.

Refresh Statistics Clear Statistics

LAN STATISTICS

Sent : 8395	Received : 8755
TX Packets Dropped : 0	RX Packets Dropped : 0
Collisions : 0	Errors : 0

WIRELESS STATISTICS

Sent : 912	Received : 15
TX Packets Dropped : 0	RX Packets Dropped : 0
Collisions : 0	Errors : 0

Helpful Hints...

This is a summary of the number of packets that have passed between the Wireless and the LAN since the device was last initialized.

WIRELESS

Copyright © 2012 D-Link Corporation/D-Link Systems, Inc.

Help

This screen gives you more information about the various parts of the configuration interface. Click on a link to learn more about that topic.

The screenshot shows the D-Link DIR-505 HotSpot configuration interface. At the top, there is a D-Link logo on an orange background. Below the logo is a navigation bar with tabs for SETUP, ADVANCED, MAINTENANCE, STATUS, and HELP. The HELP tab is selected. The main content area is titled 'HELP MENU' and lists links for Setup, Advanced, Maintenance, and Status. A 'Helpful Hints...' section on the right provides additional information. The bottom of the page features a 'WIRELESS' header and a copyright notice.

DIR-505 // HotSpot	SETUP	ADVANCED	MAINTENANCE	STATUS	HELP
MENU	HELP MENU Setup <ul style="list-style-type: none">• Wizard• Wireless Setup• Lan Setup Advanced <ul style="list-style-type: none">• Advanced Wireless Maintenance <ul style="list-style-type: none">• Admin• System• Firmware• Time Status <ul style="list-style-type: none">• Device Info• Logs• Statistics				Helpful Hints... Click on the links for more informations of each section in the GUI.
WIRELESS					
Copyright © 2012 D-Link Corporation/D-Link Systems, Inc.					

Connecting a Wireless Client

WPS Button

The easiest and most secure way to connect your wireless devices to the router is WPS (Wi-Fi Protected Setup). Most wireless devices such as wireless adapters, media players, Blu-ray DVD players, wireless printers and cameras will have a WPS button (or a software utility with WPS) that you can press to connect to the DIR-505 router. Please refer to your user manual for the wireless device you want to connect to make sure you understand how to enable WPS. Once you know, follow the steps below:

Step 1 - Press the WPS button on the DIR-505 for about 1 second. The WPS button will start to blink.



Step 2 - Within 2 minutes, press the WPS button on your wireless client (or launch the software utility and start the WPS process).

Step 3 - Allow up to 1 minute to configure. Once the WPS light stops blinking, you will be connected and your wireless connection will be secure with WPA2.

Windows® 7

WPA/WPA2

It is recommended to enable wireless security (WPA/WPA2) on your wireless router or access point before configuring your wireless adapter. If you are joining an existing network, you will need to know the security key or passphrase being used.

1. Click on the wireless icon in your system tray (lower-right corner).

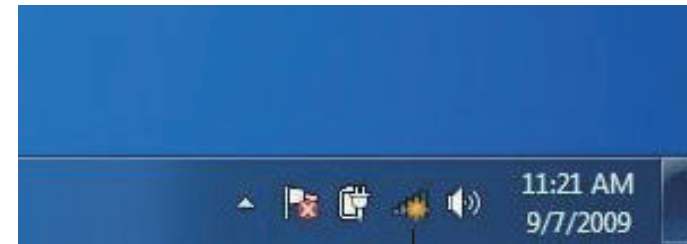

Wireless Icon

2. The utility will display any available wireless networks in your area.



3. Highlight the wireless network (SSID) you would like to connect to and click the **Connect** button.

If you get a good signal but cannot access the Internet, check your TCP/IP settings for your wireless adapter. Refer to the Networking Basics section in this manual for more information.



4. The following window appears while your computer tries to connect to the router.

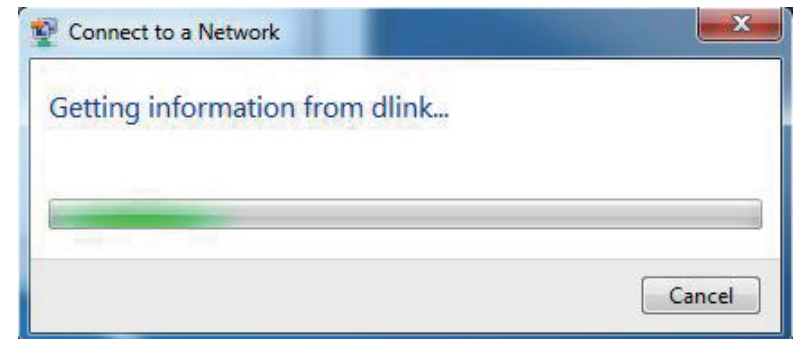

5. Enter the same security key or passphrase that is on your router and click **Connect**. You can also connect by pushing the WPS button on the router.

It may take 20-30 seconds to connect to the wireless network. If the connection fails, please verify that the security settings are correct. The key or passphrase must be exactly the same as on the wireless router.

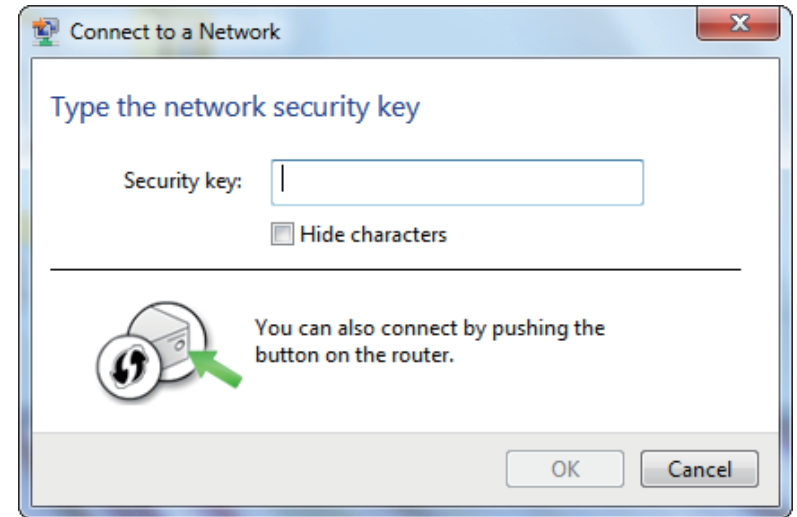

WPS

The WPS feature of the DIR-505 can be configured using Windows® 7. Carry out the following steps to use Windows® 7 to configure the WPS feature:

1. Click the **Start** button and select **Computer** from the Start menu.

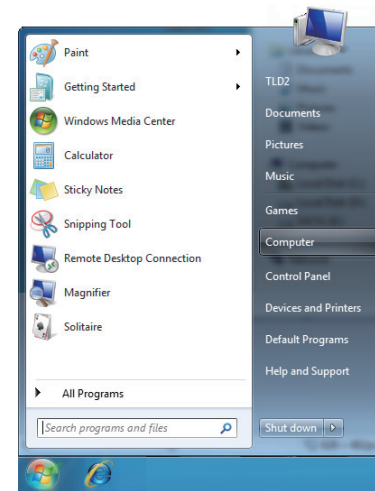

2. Click **Network** on the left side.

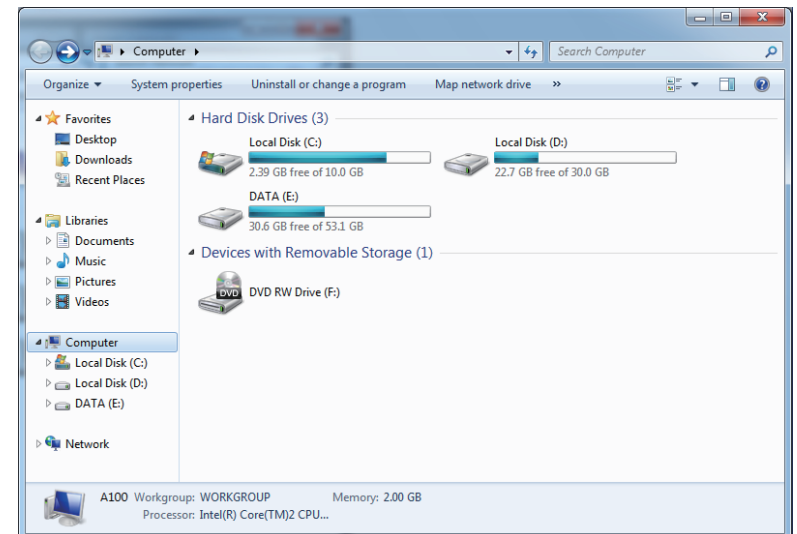

3. Double-click the DIR-505.

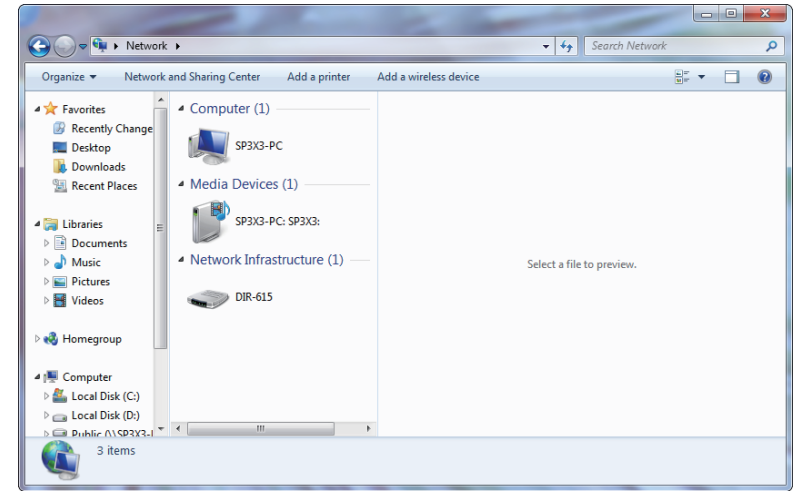

4. Input the WPS PIN number (displayed in the WPS window on the Router's LCD screen or in the **Setup** > **Wireless Setup** menu in the Router's Web UI) and click **Next**.

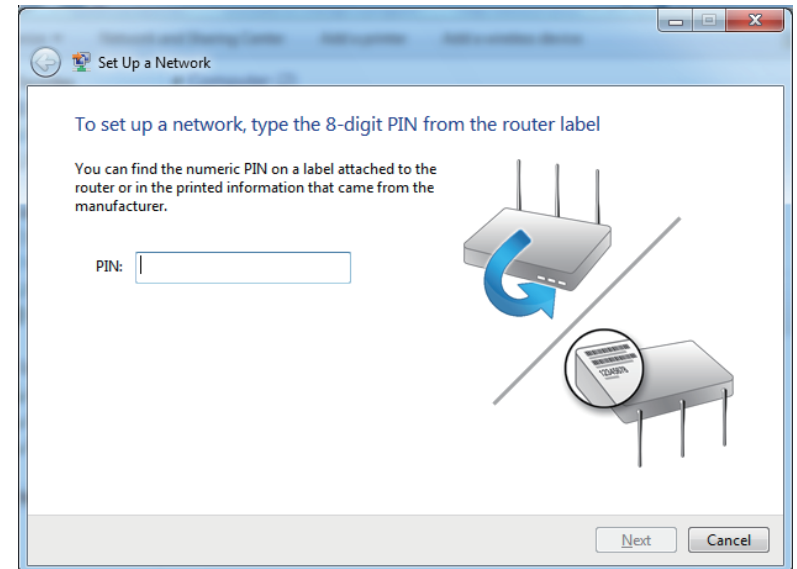

5. Type a name to identify the network.

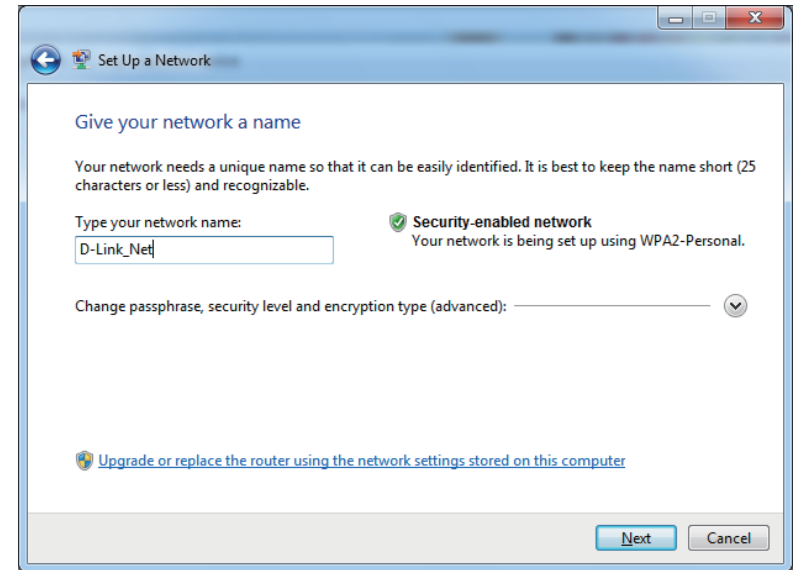

6. To configure advanced settings, click the  icon.

Click **Next** to continue.

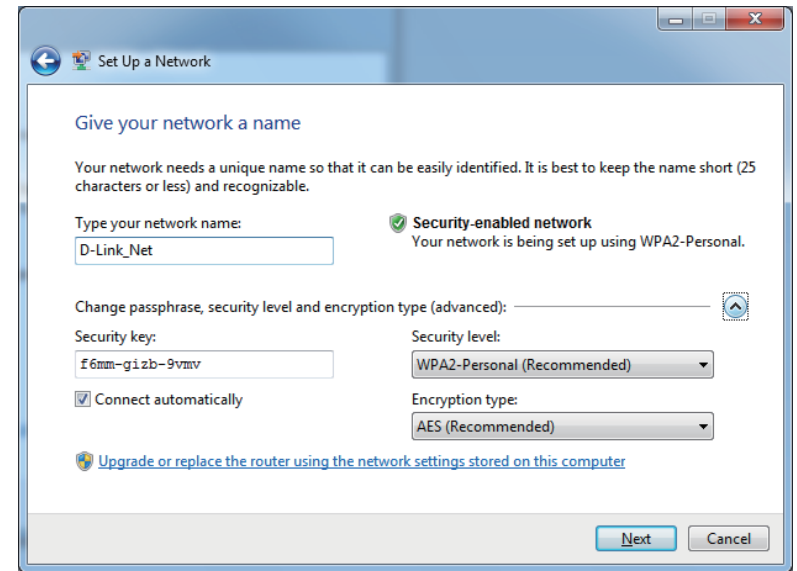

7. The following window appears while the Router is being configured.

Wait for the configuration to complete.

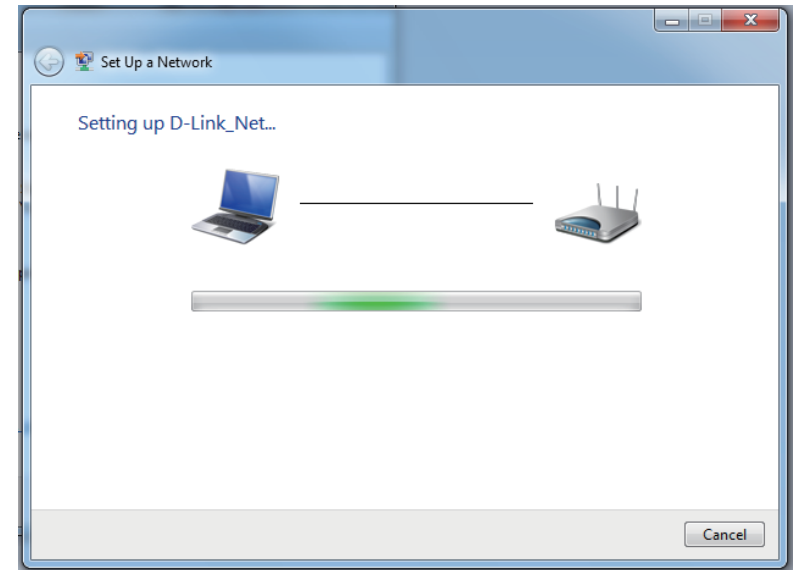

8. The following window informs you that WPS on the router has been setup successfully.

Make a note of the security key as you may need to provide this security key if adding an older wireless device to the network in the future.

9. Click **Close** to complete WPS setup.

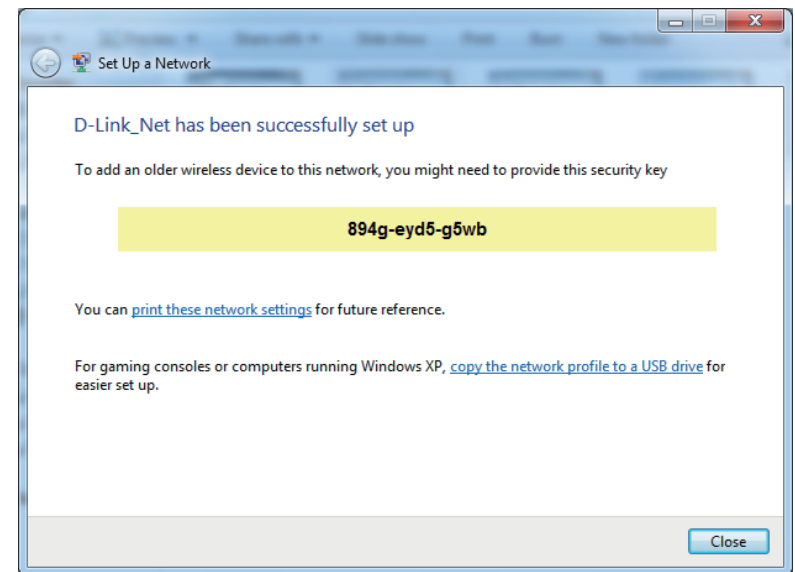

Windows Vista®

Windows Vista® users may use the built-in wireless utility. If you are using another company's utility or Windows® 2000, please refer to the user manual of your wireless adapter for help with connecting to a wireless network. Most utilities will have a "site survey" option similar to the Windows Vista® utility as seen below.

If you receive the **Wireless Networks Detected** bubble, click on the center of the bubble to access the utility.

or

Right-click on the wireless computer icon in your system tray (lower-right corner next to the time). Select **Connect to a network**.

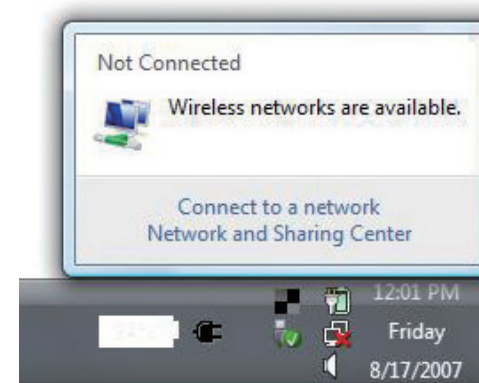

The utility will display any available wireless networks in your area. Click on a network (displayed using the SSID) and click the **Connect** button.

If you get a good signal but cannot access the Internet, check you TCP/IP settings for your wireless adapter. Refer to the **Networking Basics** section in this manual for more information.

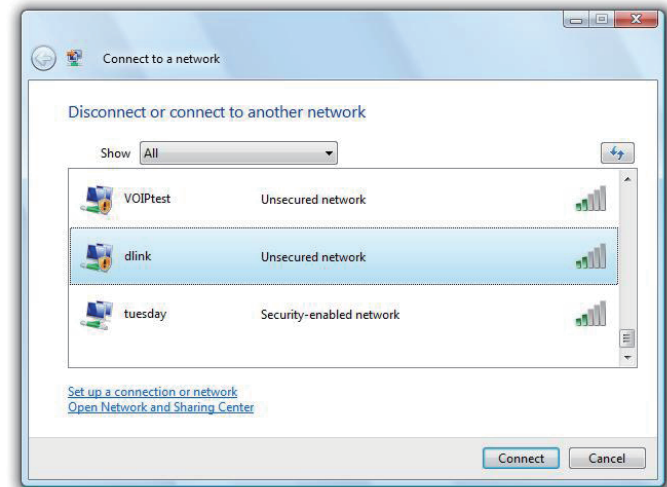

WPA/WPA2

It is recommended to enable wireless security (WPA/WPA2) on your wireless router or access point before configuring your wireless adapter. If you are joining an existing network, you will need to know the security key or passphrase being used.

1. Open the Windows Vista® Wireless Utility by right-clicking on the wireless computer icon in your system tray (lower right corner of screen). Select **Connect to a network**.

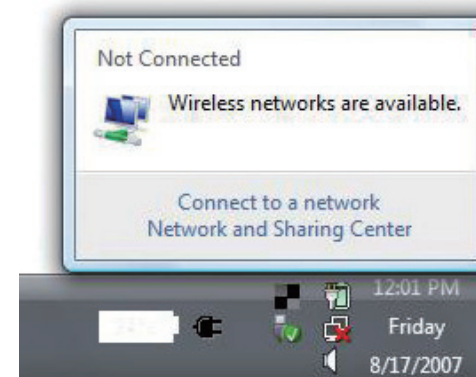

2. Highlight the wireless network (SSID) you would like to connect to and click **Connect**.

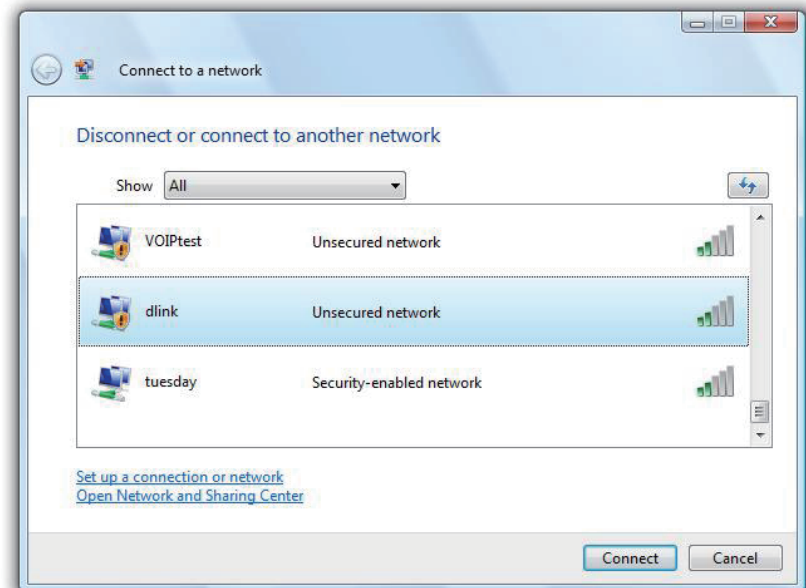

3. Enter the same security key or passphrase that is on your router and click **Connect**.

It may take 20-30 seconds to connect to the wireless network. If the connection fails, please verify that the security settings are correct. The key or passphrase must be exactly the same as on the wireless router.

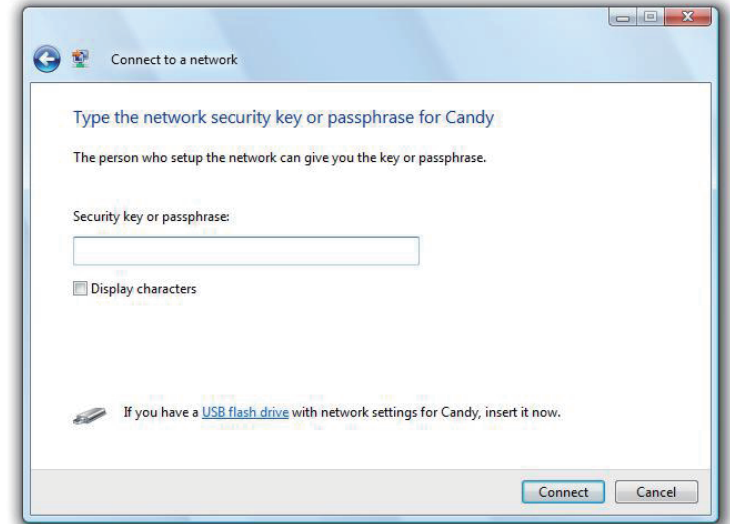

WPS/WCN 2.0

The router supports Wi-Fi protection, referred to as WCN 2.0 in Windows Vista®. The following instructions for setting this up depends on whether you are using Windows Vista® to configure the router or third party software.

When you first set up the router, Wi-Fi protection is disabled and unconfigured. To enjoy the benefits of Wi-Fi protection, the router must be both enabled and configured. There are three basic methods to accomplish this: use Windows Vista's built-in support for WCN 2.0, use software provided by a third party, or manually configure.

If you are running Windows Vista®, log into the router and click the **Enable** checkbox in the **Basic > Wireless** section. Use the Current PIN that is displayed on the **Advanced > Wi-Fi Protected Setup** section or choose to click the **Generate New PIN** button or **Reset PIN to Default** button.

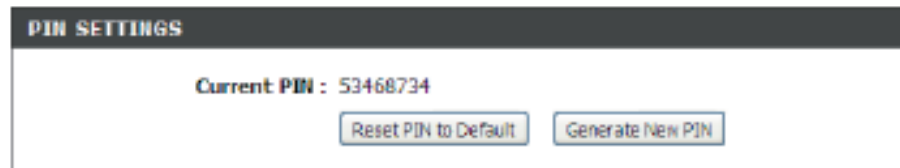

If you are using third party software to set up Wi-Fi Protection, carefully follow the directions. When you are finished, proceed to the next section to set up the newly-configured router.

Windows® XP

Windows® XP users may use the built-in wireless utility (Zero Configuration Utility). The following instructions are for Service Pack 2 users. If you are using another company's utility, please refer to the user manual of your wireless adapter for help with connecting to a wireless network. Most utilities will have a "site survey" option similar to the Windows® XP utility as seen below.

If you receive the **Wireless Networks Detected** bubble, click on the center of the bubble to access the utility.

or

Right-click on the wireless computer icon in your system tray (lower-right corner next to the time). Select **View Available Wireless Networks**.

The utility will display any available wireless networks in your area. Click on a network (displayed using the SSID) and click the **Connect** button.

If you get a good signal but cannot access the Internet, check you TCP/IP settings for your wireless adapter. Refer to the **Networking Basics** section in this manual for more information.

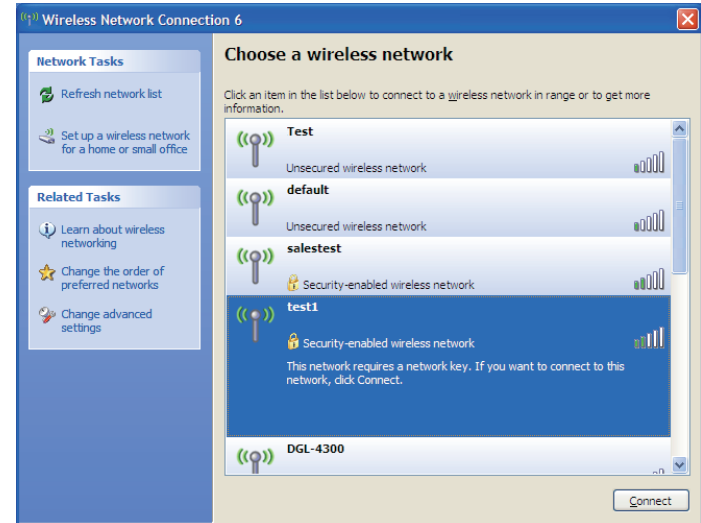
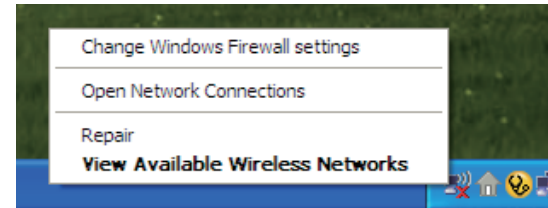
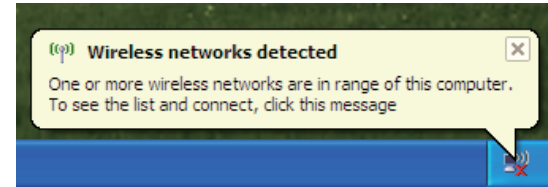

WPA/WPA2

It is recommended to enable WPA on your wireless router or access point before configuring your wireless adapter. If you are joining an existing network, you will need to know the WPA key being used.

1. Open the Windows® XP Wireless Utility by right-clicking on the wireless computer icon in your system tray (lower-right corner of screen). Select **View Available Wireless Networks**.
2. Highlight the wireless network (SSID) you would like to connect to and click **Connect**.

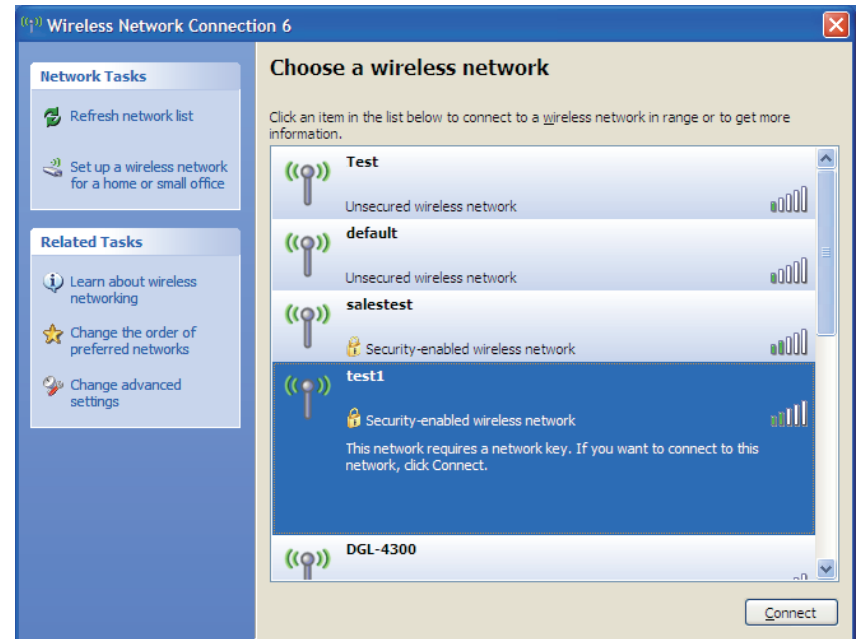
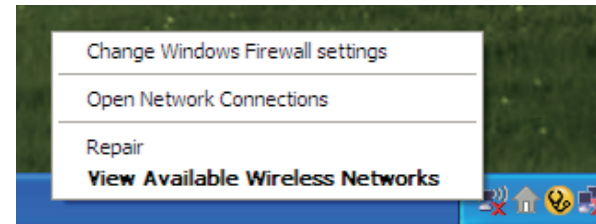

3. The **Wireless Network Connection** box will appear. Enter the WPA-PSK passphrase and click **Connect**.

It may take 20-30 seconds to connect to the wireless network. If the connection fails, please verify that the WPA-PSK settings are correct. The WPA-PSK passphrase must be exactly the same as on the wireless router.

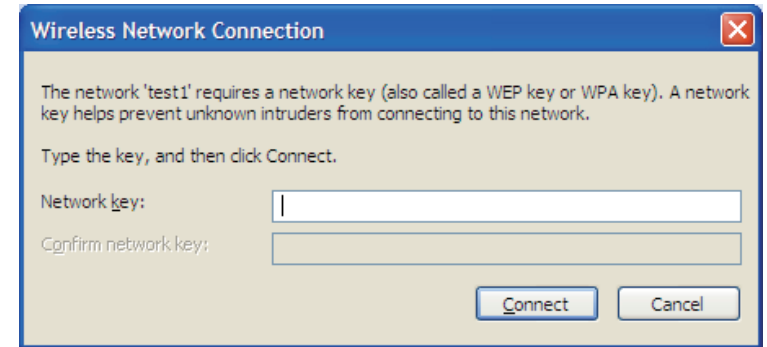

Troubleshooting

This chapter provides solutions to problems that can occur during the installation and operation of the DIR-505. Read the following descriptions if you are having problems. The examples below are illustrated in Windows® XP. If you have a different operating system, the screenshots on your computer will look similar to the following examples.

1. Why can't I access the web-based configuration utility?

When entering the IP address of the D-Link router (192.168.0.1 for example), you are not connecting to a website nor do you have to be connected to the Internet. The device has the utility built-in to a ROM chip in the device itself. Your computer must be on the same IP subnet to connect to the web-based utility.

- Make sure you have an updated Java-enabled web browser. We recommend the following:
 - Microsoft Internet Explorer® 6.0 and higher
 - Mozilla Firefox 3.0 and higher
 - Google™ Chrome 2.0 and higher
 - Apple Safari 3.0 and higher
- Verify physical connectivity by checking for solid link lights on the device. If you do not get a solid link light, try using a different cable or connect to a different port on the device if possible. If the computer is turned off, the link light may not be on.
- Disable any Internet security software running on the computer. Software firewalls such as Zone Alarm, Black Ice, Sygate, Norton Personal Firewall, and Windows® XP firewall may block access to the configuration pages. Check the help files included with your firewall software for more information on disabling or configuring it.

- Configure your Internet settings:
 - Go to **Start > Settings > Control Panel**. Double-click the **Internet Options** icon. From the **Security** tab, click the button to restore the settings to their defaults.
 - Click the **Connection** tab and set the dial-up option to Never Dial a Connection. Click the LAN Settings button. Make sure nothing is checked. Click **OK**.
 - Go to the **Advanced** tab and click the button to restore these settings to their defaults. Click **OK** three times.
 - Close your web browser (if open) and open it.
- Access the web management. Open your web browser and enter the IP address of your D-Link router in the address bar. This should open the login page for your web management.
- If you still cannot access the configuration, unplug the power to the router for 10 seconds and plug back in. Wait about 30 seconds and try accessing the configuration. If you have multiple computers, try connecting using a different computer.

2. What can I do if I forgot my password?

If you forgot your password, you must reset your router. Unfortunately this process will change all your settings back to the factory defaults.

To reset the router, locate the reset button (hole) on the rear panel of the unit. With the router powered on, use a paperclip to hold the button down for 10 seconds. Release the button and the router will go through its reboot process. Wait about 30 seconds to access the router. The default IP address is 192.168.0.1. When logging in, the username is **admin** and leave the password box empty.

3. Why can't I connect to certain sites or send and receive emails when connecting through my router?

If you are having a problem sending or receiving email, or connecting to secure sites such as eBay, banking sites, and Hotmail, we suggest lowering the MTU in increments of ten (Ex. 1492, 1482, 1472, etc).

To find the proper MTU Size, you'll have to do a special ping of the destination you're trying to go to. A destination could be another computer, or a URL.

- Click on **Start** and then click **Run**.
- Windows® 95, 98, and Me users type in **command** (Windows® NT, 2000, XP, Vista®, and 7 users type in **cmd**) and press **Enter** (or click **OK**).
- Once the window opens, you'll need to do a special ping. Use the following syntax:

ping [url] [-f] [-l] [MTU value]

Example: **ping yahoo.com -f -l 1472**

```
C:\>ping yahoo.com -f -l 1482
Pinging yahoo.com [66.94.234.13] with 1482 bytes of data:
Packet needs to be fragmented but DF set.
Packet needs to be fragmented but DF set.
Packet needs to be fragmented but DF set.
Packet needs to be fragmented but DF set.
Ping statistics for 66.94.234.13:
    Packets: Sent = 4, Received = 0, Lost = 4 (100% loss),
    Approximate round trip times in milli-seconds:
        Minimum = 0ms, Maximum = 0ms, Average = 0ms
C:\>ping yahoo.com -f -l 1472
Pinging yahoo.com [66.94.234.13] with 1472 bytes of data:
Reply from 66.94.234.13: bytes=1472 time=93ms TTL=52
Reply from 66.94.234.13: bytes=1472 time=109ms TTL=52
Reply from 66.94.234.13: bytes=1472 time=125ms TTL=52
Reply from 66.94.234.13: bytes=1472 time=203ms TTL=52
Ping statistics for 66.94.234.13:
    Packets: Sent = 4, Received = 4, Lost = 0 (0% loss),
    Approximate round trip times in milli-seconds:
        Minimum = 93ms, Maximum = 203ms, Average = 132ms
C:\>
```

You should start at 1472 and work your way down by 10 each time. Once you get a reply, go up by 2 until you get a fragmented packet. Take that value and add 28 to the value to account for the various TCP/IP headers. For example, let's say that 1452 was the proper value, the actual MTU size would be 1480, which is the optimum for the network we're working with ($1452+28=1480$).

Once you find your MTU, you can now configure your router with the proper MTU size.

To change the MTU rate on your router follow the steps below:

- Open your browser, enter the IP address of your router (192.168.0.1) and click **OK**.
- Enter your username (admin) and password (blank by default). Click **OK** to enter the web configuration page for the device.
- Click on **Setup** and then click **Manual Configure**.
- To change the MTU enter the number in the MTU field and click **Save Settings** to save your settings.
- Test your email. If changing the MTU does not resolve the problem, continue changing the MTU in increments of ten.

Wireless Basics

D-Link wireless products are based on industry standards to provide easy-to-use and compatible high-speed wireless connectivity within your home, business or public access wireless networks. Strictly adhering to the IEEE standard, the D-Link wireless family of products will allow you to securely access the data you want, when and where you want it. You will be able to enjoy the freedom that wireless networking delivers.

A wireless local area network (WLAN) is a cellular computer network that transmits and receives data with radio signals instead of wires. Wireless LANs are used increasingly in both home and office environments, and public areas such as airports, coffee shops and universities. Innovative ways to utilize WLAN technology are helping people to work and communicate more efficiently. Increased mobility and the absence of cabling and other fixed infrastructure have proven to be beneficial for many users.

Wireless users can use the same applications they use on a wired network. Wireless adapter cards used on laptop and desktop systems support the same protocols as Ethernet adapter cards.

Under many circumstances, it may be desirable for mobile network devices to link to a conventional Ethernet LAN in order to use servers, printers or an Internet connection supplied through the wired LAN. A Wireless Router is a device used to provide this link.

What is Wireless?

Wireless or Wi-Fi technology is another way of connecting your computer to the network without using wires. Wi-Fi uses radio frequency to connect wirelessly, so you have the freedom to connect computers anywhere in your home or office network.

Why D-Link Wireless?

D-Link is the worldwide leader and award winning designer, developer, and manufacturer of networking products. D-Link delivers the performance you need at a price you can afford. D-Link has all the products you need to build your network.

How does wireless work?

Wireless works similar to how cordless phone work, through radio signals to transmit data from one point A to point B. But wireless technology has restrictions as to how you can access the network. You must be within the wireless network range area to be able to connect your computer. There are two different types of wireless networks Wireless Local Area Network (WLAN), and Wireless Personal Area Network (WPAN).

Wireless Local Area Network (WLAN)

In a wireless local area network, a device called an Access Point (AP) connects computers to the network. The access point has a small antenna attached to it, which allows it to transmit data back and forth over radio signals. With an indoor access point as seen in the picture, the signal can travel up to 300 feet. With an outdoor access point the signal can reach out up to 30 miles to serve places like manufacturing plants, industrial locations, college and high school campuses, airports, golf courses, and many other outdoor venues.

Wireless Personal Area Network (WPAN)

Bluetooth is the industry standard wireless technology used for WPAN. Bluetooth devices in WPAN operate in a range up to 30 feet away.

Compared to WLAN the speed and wireless operation range are both less than WLAN, but in return it doesn't use nearly as much power which makes it ideal for personal devices, such as mobile phones, PDAs, headphones, laptops, speakers, and other devices that operate on batteries.

Who uses wireless?

Wireless technology has become so popular in recent years that almost everyone is using it, whether it's for home, office, business, D-Link has a wireless solution for it.

Home

- Gives everyone at home broadband access
- Surf the web, check email, instant message, etc.
- Gets rid of the cables around the house
- Simple and easy to use

Small Office and Home Office

- Stay on top of everything at home as you would at office
- Remotely access your office network from home
- Share Internet connection and printer with multiple computers
- No need to dedicate office space

Where is wireless used?

Wireless technology is expanding everywhere not just at home or office. People like the freedom of mobility and it's becoming so popular that more and more public facilities now provide wireless access to attract people. The wireless connection in public places is usually called "hotspots".

Using a D-Link Cardbus Adapter with your laptop, you can access the hotspot to connect to Internet from remote locations like: Airports, Hotels, Coffee Shops, Libraries, Restaurants, and Convention Centers.

Wireless network is easy to setup, but if you're installing it for the first time it could be quite a task not knowing where to start. That's why we've put together a few setup steps and tips to help you through the process of setting up a wireless network.

Tips

Here are a few things to keep in mind, when you install a wireless network.

Centralize your router or Access Point

Make sure you place the router/access point in a centralized location within your network for the best performance. Try to place the router/access point as high as possible in the room, so the signal gets dispersed throughout your home. If you have a two-story home, you may need a repeater to boost the signal to extend the range.

Eliminate Interference

Place home appliances such as cordless telephones, microwaves, and televisions as far away as possible from the router/access point. This would significantly reduce any interference that the appliances might cause since they operate on same frequency.

Security

Don't let you next-door neighbors or intruders connect to your wireless network. Secure your wireless network by turning on the WPA or WEP security feature on the router. Refer to product manual for detail information on how to set it up.

Networking Basics

Check your IP address

After you install your new D-Link adapter, by default, the TCP/IP settings should be set to obtain an IP address from a DHCP server (i.e. wireless router) automatically. To verify your IP address, please follow the steps below.

Click on **Start > Run**. In the run box type **cmd** and click **OK**. (Windows® 7/Vista® users type **cmd** in the **Start Search** box.)

At the prompt, type **ipconfig** and press **Enter**.

This will display the IP address, subnet mask, and the default gateway of your adapter.

If the address is 0.0.0.0, check your adapter installation, security settings, and the settings on your router. Some firewall software programs may block a DHCP request on newly installed adapters.

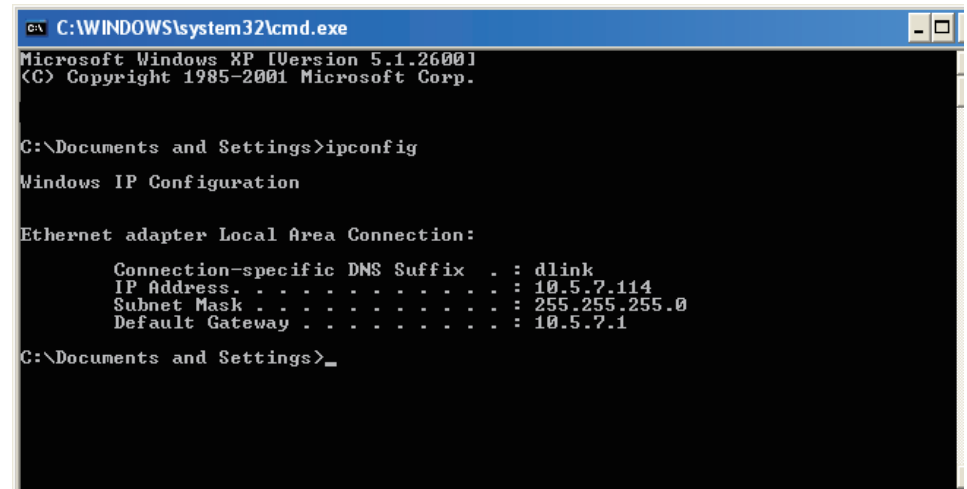

```
C:\WINDOWS\system32\cmd.exe
Microsoft Windows XP [Version 5.1.2600]
(C) Copyright 1985-2001 Microsoft Corp.

C:\Documents and Settings>ipconfig

Windows IP Configuration

Ethernet adapter Local Area Connection:

    Connection-specific DNS Suffix  . : dlink
    IP Address . . . . . : 10.5.7.114
    Subnet Mask . . . . . : 255.255.255.0
    Default Gateway . . . . . : 10.5.7.1

C:\Documents and Settings>_
```

Statically Assign an IP address

If you are not using a DHCP capable gateway/router, or you need to assign a static IP address, please follow the steps below:

- Step 1**
- Windows® 7 - Click on **Start > Control Panel > Network and Internet > Network and Sharing Center.**
 - Windows Vista® - Click on **Start > Control Panel > Network and Internet > Network and Sharing Center > Manage Network Connections.**
 - Windows® XP - Click on **Start > Control Panel > Network Connections.**
 - Windows® 2000 - From the desktop, right-click **My Network Places > Properties.**

Step 2
Right-click on the **Local Area Connection** which represents your network adapter and select **Properties.**

Step 3
Highlight **Internet Protocol (TCP/IP)** and click **Properties.**

Step 4
Click **Use the following IP address** and enter an IP address that is on the same subnet as your network or the LAN IP address on your router.

Example: If the router's LAN IP address is 192.168.0.1, make your IP address 192.168.0.X where X is a number between 2 and 99. Make sure that the number you choose is not in use on the network. Set the Default Gateway the same as the LAN IP address of your router (I.E. 192.168.0.1).

Set Primary DNS the same as the LAN IP address of your router (192.168.0.1). The Secondary DNS is not needed or you may enter a DNS server from your ISP.

Step 5
Click **OK** twice to save your settings.

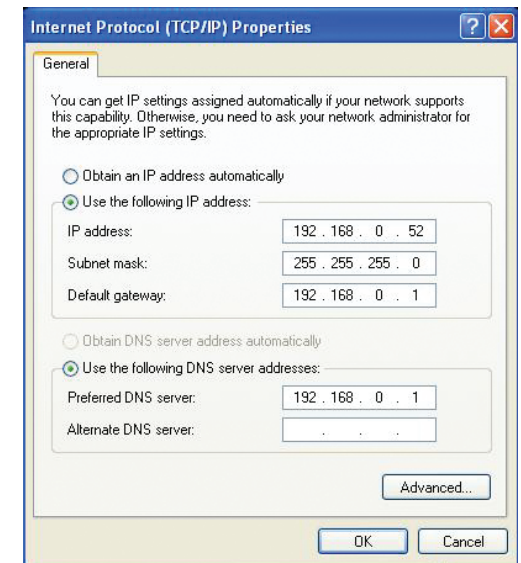

Technical Specifications

Standards

- IEEE 802.11g, compatible with 802.11n devices
- IEEE 802.3
- IEEE 802.3u

Wireless Modes

- Router/AP Mode
- Repeater Mode
- Wi-Fi Hot Spot Mode

Wireless Frequency Range ¹

- 2.4 GHz to 2.4835 GHz

Antennas

- Internal Antenna

Security

- Wi-Fi Protected Access (WPA/WPA2)
- WPS™ (PBC)

Advanced Features

- SharePort™ Mobile app for iOS ²
- QRS Mobile setup app for iOS ³
- VPN pass-through
- Guest Zone Support
- UPnP™ Support
- Web File Access Support
- Wi-Fi WMM Quality of Service

Advanced Firewall Features

- Network Address Translation (NAT)
- Stateful Packet Inspection (SPI)
- MAC Address Filtering
- DMZ Support

Device Management

- Web UI

Diagnostic LEDs

- Power/WPS

Operating Temperature

- 0 to 40 °C (32 to 104 °F)

Operating Humidity

- 0% to 90% non-condensing

Certifications

- CE
- Wi-Fi Certified
- FCC
- IC

Dimensions

- 68 x 42 x 51 mm (2.68 x 1.65 x 2 inches)

Weight

- 113.4 grams (0.25 lb)

¹ Frequency Range varies depending on local regulations

² SharePort Mobile app functionality only available when in Router or Wi-Fi Hotspot mode.

³ QRS Mobile app is for Router mode setup only.

GPL Code Statement

This D-Link product includes software code developed by third parties, including software code subject to the GNU General Public License ("GPL") or GNU Lesser General Public License ("LGPL"). As applicable, the terms of the GPL and LGPL, and information on obtaining access to the GPL code and LGPL code used in this product, are available to you at:

<http://tsd.dlink.com.tw/GPL.asp>

The GPL code and LGPL code used in this product is distributed WITHOUT ANY WARRANTY and is subject to the copyrights of one or more authors. For details, see the GPL code and the LGPL code for this product and the terms of the GPL and LGPL.

WRITTEN OFFER FOR GPL AND LGPL SOURCE CODE

Where such specific license terms entitle you to the source code of such software, D-Link will provide upon written request via email and/or traditional paper mail the applicable GPL and LGPL source code files via CD-ROM for a nominal cost to cover shipping and media charges as allowed under the GPL and LGPL.

Please direct all inquiries to:
Email: GPLCODE@DLink.com
Snail Mail:
Attn: GPLSOURCE REQUEST
D-Link Systems, Inc.
17595 Mt. Herrmann Street
Fountain Valley, CA 92708

GNU GENERAL PUBLIC LICENSE Version 3, 29 June 2007

Copyright (C) 2007 Free Software Foundation, Inc. <<http://fsf.org/>> Everyone is permitted to copy and distribute verbatim copies of this license document, but changing it is not allowed.

Preamble

The GNU General Public License is a free, copyleft license for software and other kinds of works.

The licenses for most software and other practical works are designed to take away your freedom to share and change the works. By contrast, the GNU General Public License is intended to guarantee your freedom to share and change all versions of a program--to make sure it remains free software for all its users. We, the Free Software Foundation, use the GNU General Public License for most of our software; it applies also to any other work released this way by its authors. You can apply it to your programs, too.

When we speak of free software, we are referring to freedom, not price. Our General Public Licenses are designed to make sure that you have the freedom to distribute copies of free software (and charge for them if you wish), that you receive source code or can get it if you want it, that you can change the software or use pieces of it in new free programs, and that you know you can do these things.

To protect your rights, we need to prevent others from denying you these rights or asking you to surrender the rights. Therefore, you have certain responsibilities if you distribute copies of the software, or if you modify it: responsibilities to respect the freedom of others.

For example, if you distribute copies of such a program, whether gratis or for a fee, you must pass on to the recipients the same freedoms that you received. You must make sure that they, too, receive or can get the source code. And you must show them these terms so they know their rights.

Developers that use the GNU GPL protect your rights with two steps:

(1) assert copyright on the software, and (2) offer you this License giving you legal permission to copy, distribute and/or modify it.

For the developers' and authors' protection, the GPL clearly explains that there is no warranty for this free software. For both users' and authors' sake, the GPL requires that modified versions be marked as changed, so that their problems will not be attributed erroneously to authors of previous versions.

Some devices are designed to deny users access to install or run modified versions of the software inside them, although the manufacturer can do so. This is fundamentally incompatible with the aim of protecting users' freedom to change the software. The systematic pattern of such abuse occurs in the area of products for individuals to use, which is precisely where it is most unacceptable. Therefore, we have designed this version of the GPL to prohibit the practice for those products. If such problems arise substantially in other domains, we stand ready to extend this provision to those domains in future versions of the GPL, as needed to protect the freedom of users.

Finally, every program is threatened constantly by software patents. States should not allow patents to restrict development and use of software on general-purpose computers, but in those that do, we wish to avoid the special danger that patents applied to a free program could make it effectively proprietary. To prevent this, the GPL assures that patents cannot be used to render the program non-free.

The precise terms and conditions for copying, distribution and modification follow.

TERMS AND CONDITIONS

0. Definitions.

“This License” refers to version 3 of the GNU General Public License.

“Copyright” also means copyright-like laws that apply to other kinds of works, such as semiconductor masks.

“The Program” refers to any copyrightable work licensed under this License. Each licensee is addressed as “you”. “Licensees” and “recipients” may be individuals or organizations.

To “modify” a work means to copy from or adapt all or part of the work in a fashion requiring copyright permission, other than the making of an exact copy. The resulting work is called a “modified version” of the earlier work or a work “based on” the earlier work.

A “covered work” means either the unmodified Program or a work based on the Program.

To “propagate” a work means to do anything with it that, without permission, would make you directly or secondarily liable for infringement under applicable copyright law, except executing it on a computer or modifying a private copy. Propagation includes copying, distribution (with or without modification), making available to the public, and in some countries other activities as well.

To “convey” a work means any kind of propagation that enables other parties to make or receive copies. Mere interaction with a user through a computer network, with no transfer of a copy, is not conveying.

An interactive user interface displays “Appropriate Legal Notices” to the extent that it includes a convenient and prominently visible feature that (1) displays an appropriate copyright notice, and (2) tells the user that there is no warranty for the work (except to the extent that warranties are provided), that licensees may convey the work under this License, and how to view a copy of this License. If the interface presents a list of user commands or options, such as a menu, a prominent item in the list meets this criterion.

1. Source Code.

The “source code” for a work means the preferred form of the work for making modifications to it. “Object code” means any non-source form of a work.

A “Standard Interface” means an interface that either is an official standard defined by a recognized standards body, or, in the case of interfaces specified for a particular programming language, one that is widely used among developers working in that language.

The “System Libraries” of an executable work include anything, other than the work as a whole, that (a) is included in the normal form of packaging a Major Component, but which is not part of that Major Component, and (b) serves only to enable use of the work with that Major Component, or to implement a Standard Interface for which an implementation is available to the public in source code form. A “Major Component”, in this context, means a major essential component (kernel, window system, and so on) of the specific operating system (if any) on which the executable work runs, or a compiler used to produce the work, or an object code interpreter used to run it.

The “Corresponding Source” for a work in object code form means all the source code needed to generate, install, and (for an executable work) run the object code and to modify the work, including scripts to control those activities. However, it does not include the work’s System Libraries, or general-purpose tools or generally available free programs which are used unmodified in performing those activities but which are not part of the work. For example, Corresponding Source includes interface definition files associated with source files for the work, and the source code for shared libraries and dynamically linked subprograms that the work is specifically designed to require, such as by intimate data communication or control flow between those subprograms and other parts of the work.

The Corresponding Source need not include anything that users can regenerate automatically from other parts of the Corresponding Source.

The Corresponding Source for a work in source code form is that same work.

2. Basic Permissions.

All rights granted under this License are granted for the term of copyright on the Program, and are irrevocable provided the stated conditions are met. This License explicitly affirms your unlimited permission to run the unmodified Program. The output from running a covered work is covered by this License only if the output, given its content, constitutes a covered work. This License acknowledges your rights of fair use or other equivalent, as provided by copyright law.

You may make, run and propagate covered works that you do not convey, without conditions so long as your license otherwise remains in force. You may convey covered works to others for the sole purpose of having them make modifications exclusively for you, or provide you with facilities for running those works, provided that you comply with the terms of this License in conveying all material for which you do not control copyright. Those thus making or running the covered works for you must do so exclusively on your behalf, under your direction and control, on terms that prohibit them from making any copies of your copyrighted material outside their relationship with you.

Conveying under any other circumstances is permitted solely under the conditions stated below. Sublicensing is not allowed; section 10 makes it unnecessary.

3. Protecting Users' Legal Rights From Anti-Circumvention Law.

No covered work shall be deemed part of an effective technological measure under any applicable law fulfilling obligations under article 11 of the WIPO copyright treaty adopted on 20 December 1996, or similar laws prohibiting or restricting circumvention of such measures.

When you convey a covered work, you waive any legal power to forbid circumvention of technological measures to the extent such circumvention is effected by exercising rights under this License with respect to the covered work, and you disclaim any intention to limit operation or modification of the work as a means of enforcing, against the work's users, your or third parties' legal rights to forbid circumvention of technological measures.

4. Conveying Verbatim Copies.

You may convey verbatim copies of the Program's source code as you receive it, in any medium, provided that you conspicuously and appropriately publish on each copy an appropriate copyright notice; keep intact all notices stating that this License and any non-permissive terms added in accord with section 7 apply to the code; keep intact all notices of the absence of any warranty; and give all recipients a copy of this License along with the Program.

You may charge any price or no price for each copy that you convey, and you may offer support or warranty protection for a fee.

5. Conveying Modified Source Versions.

You may convey a work based on the Program, or the modifications to produce it from the Program, in the form of source code under the terms of section 4, provided that you also meet all of these conditions:

- a) The work must carry prominent notices stating that you modified it, and giving a relevant date.
- b) The work must carry prominent notices stating that it is released under this License and any conditions added under section 7. This requirement modifies the requirement in section 4 to "keep intact all notices".
- c) You must license the entire work, as a whole, under this License to anyone who comes into possession of a copy. This License will therefore apply, along with any applicable section 7 additional terms, to the whole of the work, and all its parts, regardless of how they are packaged. This License gives no permission to license the work in any other way, but it does not invalidate such permission if you have separately received it.
- d) If the work has interactive user interfaces, each must display Appropriate Legal Notices; however, if the Program has interactive interfaces that do not display Appropriate Legal Notices, your work need not make them do so.

A compilation of a covered work with other separate and independent works, which are not by their nature extensions of the covered work, and which are not combined with it such as to form a larger program, in or on a volume of a storage or distribution medium, is called an "aggregate" if the compilation and its resulting copyright are not used to limit the access or legal rights of the compilation's users beyond what the individual works permit. Inclusion of a covered work in an aggregate does not cause this License to apply to the other parts of the aggregate.

6. Conveying Non-Source Forms.

You may convey a covered work in object code form under the terms of sections 4 and 5, provided that you also convey the machine-readable Corresponding Source under the terms of this License, in one of these ways:

- a) Convey the object code in, or embodied in, a physical product (including a physical distribution medium), accompanied by the Corresponding Source fixed on a durable physical medium customarily used for software interchange.
- b) Convey the object code in, or embodied in, a physical product (including a physical distribution medium), accompanied by a written offer, valid for at least three years and valid for as long as you offer spare parts or customer support for that product model, to give anyone who possesses the object code either (1) a copy of the Corresponding Source for all the software in the product that is covered by this License, on a durable physical medium customarily used for software interchange, for a price no more than your reasonable cost of physically performing this conveying of source, or (2) access to copy the Corresponding Source from a network server at no charge.
- c) Convey individual copies of the object code with a copy of the written offer to provide the Corresponding Source. This alternative is allowed only occasionally and noncommercially, and only if you received the object code with such an offer, in accord with subsection 6b.
- d) Convey the object code by offering access from a designated place (gratis or for a charge), and offer equivalent access to the Corresponding Source in the same way through the same place at no further charge. You need not require recipients to copy the Corresponding Source along with the object code. If the place to copy the object code is a network server, the Corresponding Source may be on a different server (operated by you or a third party) that supports equivalent copying facilities, provided you maintain clear directions next to the object code saying where to find the Corresponding Source. Regardless of what server hosts the Corresponding Source, you remain obligated to ensure that it is available for as long as needed to satisfy these requirements.
- e) Convey the object code using peer-to-peer transmission, provided you inform other peers where the object code and Corresponding Source of the work are being offered to the general public at no charge under subsection 6d.

A separable portion of the object code, whose source code is excluded from the Corresponding Source as a System Library, need not be included in conveying the object code work.

A “User Product” is either (1) a “consumer product”, which means any tangible personal property which is normally used for personal, family, or household purposes, or (2) anything designed or sold for incorporation into a dwelling. In determining whether a product is a consumer product, doubtful cases shall be resolved in favor of coverage. For a particular product received by a particular user, “normally used” refers to a typical or common use of that class of product, regardless of the status of the particular user or of the way in which the particular user actually uses, or expects or is expected to use, the product. A product is a consumer product regardless of whether the product has substantial commercial, industrial or non-consumer uses, unless such uses represent the only significant mode of use of the product.

“Installation Information” for a User Product means any methods, procedures, authorization keys, or other information required to install and execute modified versions of a covered work in that User Product from a modified version of its Corresponding Source. The information must suffice to ensure that the continued functioning of the modified object code is in no case prevented or interfered with solely because modification has been made.

If you convey an object code work under this section in, or with, or specifically for use in, a User Product, and the conveying occurs as part of a transaction in which the right of possession and use of the User Product is transferred to the recipient in perpetuity or for a fixed term (regardless of how the transaction is characterized), the Corresponding Source conveyed under this section must be accompanied by the Installation Information. But this requirement does not apply if neither you nor any third party retains the ability to install modified object code on the User Product (for example, the work has been installed in ROM).

The requirement to provide Installation Information does not include a requirement to continue to provide support service, warranty, or updates for a work that has been modified or installed by the recipient, or for the User Product in which it has been modified or installed. Access to a network may be denied when the modification itself materially and adversely affects the operation of the network or violates the rules and protocols for communication across the network.

Corresponding Source conveyed, and Installation Information provided, in accord with this section must be in a format that is publicly documented (and with an implementation available to the public in source code form), and must require no special password or key for unpacking, reading or copying.

7. Additional Terms.

“Additional permissions” are terms that supplement the terms of this License by making exceptions from one or more of its conditions. Additional permissions that are applicable to the entire Program shall be treated as though they were included in this License, to the extent that they are valid under applicable law. If additional permissions apply only to part of the Program, that part may be used separately under those permissions, but the entire Program remains governed by this License without regard to the additional permissions.

When you convey a copy of a covered work, you may at your option remove any additional permissions from that copy, or from any part of it. (Additional permissions may be written to require their own removal in certain cases when you modify the work). You may place additional permissions on material, added by you to a covered work, for which you have or can give appropriate copyright permission.

Notwithstanding any other provision of this License, for material you add to a covered work, you may (if authorized by the copyright holders of that material) supplement the terms of this License with terms:

- a) Disclaiming warranty or limiting liability differently from the terms of sections 15 and 16 of this License; or
- b) Requiring preservation of specified reasonable legal notices or author attributions in that material or in the Appropriate Legal Notices displayed by works containing it; or
- c) Prohibiting misrepresentation of the origin of that material, or requiring that modified versions of such material be marked in reasonable ways as different from the original version; or
- d) Limiting the use for publicity purposes of names of licensors or authors of the material; or
- e) Declining to grant rights under trademark law for use of some trade names, trademarks, or service marks; or
- f) Requiring indemnification of licensors and authors of that material by anyone who conveys the material (or modified versions of it) with contractual assumptions of liability to the recipient, for any liability that these contractual assumptions directly impose on those licensors and authors.

All other non-permissive additional terms are considered “further restrictions” within the meaning of section 10. If the Program as you received it, or any part of it, contains a notice stating that it is governed by this License along with a term that is a further restriction, you may remove that term. If a license document contains a further restriction but permits relicensing or conveying under this License, you may add to a covered work material governed by the terms of that license document, provided that the further restriction does not survive such relicensing or conveying.

If you add terms to a covered work in accord with this section, you must place, in the relevant source files, a statement of the additional terms that apply to those files, or a notice indicating where to find the applicable terms.

Additional terms, permissive or non-permissive, may be stated in the form of a separately written license, or stated as exceptions; the above requirements apply either way.

8. Termination.

You may not propagate or modify a covered work except as expressly provided under this License. Any attempt otherwise to propagate or modify it is void, and will automatically terminate your rights under this License (including any patent licenses granted under the third paragraph of section 11).

However, if you cease all violation of this License, then your license from a particular copyright holder is reinstated (a) provisionally, unless and until the copyright holder explicitly and finally terminates your license, and (b) permanently, if the copyright holder fails to notify you of the violation by some reasonable means prior to 60 days after the cessation.

Moreover, your license from a particular copyright holder is reinstated permanently if the copyright holder notifies you of the violation by some reasonable means, this is the first time you have received notice of violation of this License (for any work) from that copyright holder, and you cure the violation prior to 30 days after your receipt of the notice.

Termination of your rights under this section does not terminate the licenses of parties who have received copies or rights

from you under this License. If your rights have been terminated and not permanently reinstated, you do not qualify to receive new licenses for the same material under section 10.

9. Acceptance Not Required for Having Copies.

You are not required to accept this License in order to receive or run a copy of the Program. Ancillary propagation of a covered work occurring solely as a consequence of using peer-to-peer transmission to receive a copy likewise does not require acceptance. However, nothing other than this License grants you permission to propagate or modify any covered work. These actions infringe copyright if you do not accept this License. Therefore, by modifying or propagating a covered work, you indicate your acceptance of this License to do so.

10. Automatic Licensing of Downstream Recipients.

Each time you convey a covered work, the recipient automatically receives a license from the original licensors, to run, modify and propagate that work, subject to this License. You are not responsible for enforcing compliance by third parties with this License.

An “entity transaction” is a transaction transferring control of an organization, or substantially all assets of one, or subdividing an organization, or merging organizations. If propagation of a covered work results from an entity transaction, each party to that transaction who receives a copy of the work also receives whatever licenses to the work the party’s predecessor in interest had or could give under the previous paragraph, plus a right to possession of the Corresponding Source of the work from the predecessor in interest, if the predecessor has it or can get it with reasonable efforts.

You may not impose any further restrictions on the exercise of the rights granted or affirmed under this License. For example, you may not impose a license fee, royalty, or other charge for exercise of rights granted under this License, and you may not initiate litigation (including a cross-claim or counterclaim in a lawsuit) alleging that any patent claim is infringed by making, using, selling, offering for sale, or importing the Program or any portion of it.

11. Patents.

A “contributor” is a copyright holder who authorizes use under this License of the Program or a work on which the Program is based. The work thus licensed is called the contributor’s “contributor version”.

A contributor’s “essential patent claims” are all patent claims owned or controlled by the contributor, whether already acquired or hereafter acquired, that would be infringed by some manner, permitted by this License, of making, using, or selling its contributor version, but do not include claims that would be infringed only as a consequence of further modification of the contributor version. For purposes of this definition, “control” includes the right to grant patent sublicenses in a manner consistent with the requirements of this License.

Each contributor grants you a non-exclusive, worldwide, royalty-free patent license under the contributor’s essential patent claims, to make, use, sell, offer for sale, import and otherwise run, modify and propagate the contents of its contributor version.

In the following three paragraphs, a “patent license” is any express agreement or commitment, however denominated, not to enforce a patent (such as an express permission to practice a patent or covenant not to sue for patent infringement). To “grant” such a patent license to a party means to make such an agreement or commitment not to enforce a patent against the party.

If you convey a covered work, knowingly relying on a patent license, and the Corresponding Source of the work is not available for anyone to copy, free of charge and under the terms of this License, through a publicly available network server or other readily accessible means, then you must either (1) cause the Corresponding Source to be so available, or (2) arrange to deprive yourself of the benefit of the patent license for this particular work, or (3) arrange, in a manner consistent with the requirements of this License, to extend the patent license to downstream recipients. “Knowingly relying” means you have actual knowledge that, but for the patent license, your conveying the covered work in a country, or your recipient’s use of the covered work in a country, would infringe one or more identifiable patents in that country that you have reason to believe are valid.

If, pursuant to or in connection with a single transaction or arrangement, you convey, or propagate by procuring conveyance of, a covered work, and grant a patent license to some of the parties receiving the covered work authorizing them to use, propagate, modify or convey a specific copy of the covered work, then the patent license you grant is automatically extended to all recipients of the covered work and works based on it.

A patent license is “discriminatory” if it does not include within the scope of its coverage, prohibits the exercise of, or is conditioned on the non-exercise of one or more of the rights that are specifically granted under this License. You may not convey a covered work if you are a party to an arrangement with a third party that is in the business of distributing software, under which you make payment to the third party based on the extent of your activity of conveying the work, and under which the third party grants, to any of the parties who would receive the covered work from you, a discriminatory patent license (a) in connection with copies of the covered work conveyed by you (or copies made from those copies), or (b) primarily for and in connection with specific products or compilations that contain the covered work, unless you entered into that arrangement, or that patent license was granted, prior to 28 March 2007.

Nothing in this License shall be construed as excluding or limiting any implied license or other defenses to infringement that may otherwise be available to you under applicable patent law.

12. No Surrender of Others’ Freedom.

If conditions are imposed on you (whether by court order, agreement or otherwise) that contradict the conditions of this License, they do not excuse you from the conditions of this License. If you cannot convey a covered work so as to satisfy simultaneously your obligations under this License and any other pertinent obligations, then as a consequence you may not convey it at all. For example, if you agree to terms that obligate you to collect a royalty for further conveying from those to whom you convey the Program, the only way you could satisfy both those terms and this License would be to refrain entirely from conveying the Program.

13. Use with the GNU Affero General Public License.

Notwithstanding any other provision of this License, you have permission to link or combine any covered work with a work licensed under version 3 of the GNU Affero General Public License into a single combined work, and to convey the resulting work. The terms of this License will continue to apply to the part which is the covered work, but the special requirements of the GNU Affero General Public License, section 13, concerning interaction through a network will apply to the combination as such.

14. Revised Versions of this License.

The Free Software Foundation may publish revised and/or new versions of the GNU General Public License from time to time. Such new versions will be similar in spirit to the present version, but may differ in detail to address new problems or concerns.

Each version is given a distinguishing version number. If the Program specifies that a certain numbered version of the GNU General Public License “or any later version” applies to it, you have the option of following the terms and conditions either of that numbered version or of any later version published by the Free Software Foundation. If the Program does not specify a version number of the GNU General Public License, you may choose any version ever published by the Free Software Foundation. If the Program specifies that a proxy can decide which future versions of the GNU General Public License can be used, that proxy’s public statement of acceptance of a version permanently authorizes you to choose that version for the Program.

Later license versions may give you additional or different permissions. However, no additional obligations are imposed on any author or copyright holder as a result of your choosing to follow a later version.

15. Disclaimer of Warranty.

THERE IS NO WARRANTY FOR THE PROGRAM, TO THE EXTENT PERMITTED BY APPLICABLE LAW. EXCEPT WHEN OTHERWISE STATED IN WRITING THE COPYRIGHT HOLDERS AND/OR OTHER PARTIES PROVIDE THE PROGRAM “AS IS” WITHOUT WARRANTY OF ANY KIND, EITHER EXPRESSED OR IMPLIED, INCLUDING, BUT NOT LIMITED TO, THE IMPLIED WARRANTIES OF MERCHANTABILITY AND FITNESS FOR A PARTICULAR PURPOSE. THE ENTIRE RISK AS TO THE QUALITY AND PERFORMANCE OF THE PROGRAM IS WITH YOU. SHOULD THE PROGRAM PROVE DEFECTIVE, YOU ASSUME THE COST OF ALL NECESSARY SERVICING, REPAIR OR CORRECTION.

16. Limitation of Liability.

IN NO EVENT UNLESS REQUIRED BY APPLICABLE LAW OR AGREED TO IN WRITING WILL ANY COPYRIGHT HOLDER, OR ANY OTHER PARTY WHO MODIFIES AND/OR CONVEYS THE PROGRAM AS PERMITTED ABOVE, BE LIABLE TO YOU FOR DAMAGES, INCLUDING ANY GENERAL, SPECIAL, INCIDENTAL OR CONSEQUENTIAL DAMAGES ARISING OUT OF THE USE OR INABILITY TO USE THE PROGRAM (INCLUDING BUT NOT LIMITED TO LOSS OF DATA OR DATA BEING RENDERED INACCURATE OR LOSSES SUSTAINED BY YOU OR THIRD PARTIES OR A FAILURE OF THE PROGRAM TO OPERATE WITH ANY OTHER PROGRAMS), EVEN IF SUCH HOLDER OR OTHER PARTY HAS BEEN ADVISED OF THE POSSIBILITY OF SUCH DAMAGES.

17. Interpretation of Sections 15 and 16.

If the disclaimer of warranty and limitation of liability provided above cannot be given local legal effect according to their terms, reviewing courts shall apply local law that most closely approximates an absolute waiver of all civil liability in connection with the Program, unless a warranty or assumption of liability accompanies a copy of the Program in return for a fee.

Safety Statements

CE Mark Warning:

This is a Class B product. In a domestic environment, this product may cause radio interference, in which case the user may be required to take adequate measures.

FCC Statement:

This equipment has been tested and found to comply with the limits for a Class B digital device, pursuant to Part 15 of the FCC Rules. These limits are designed to provide reasonable protection against harmful interference in a residential installation. This equipment generates, uses and can radiate radio frequency energy and, if not installed and used in accordance with the instructions, may cause harmful interference to radio communications. However, there is no guarantee that interference will not occur in a particular installation. If this equipment does cause harmful interference to radio or television reception, which can be determined by turning the equipment off and on, the user is encouraged to try to correct the interference by one of the following measures:

- Reorient or relocate the receiving antenna.
- Increase the separation between the equipment and receiver.
- Connect the equipment into an outlet on a circuit different from that to which the receiver is connected.
- Consult the dealer or an experienced radio/TV technician for help.

This device complies with Part 15 of the FCC Rules. Operation is subject to the following two conditions: (1) This device may not cause harmful interference, and (2) this device must accept any interference received, including interference that may cause undesired operation.

FCC Caution:

Any changes or modifications not expressly approved by the party responsible for compliance could void the user's authority to operate this equipment.

Operations in the 5.15-5.25GHz / 5.470 ~ 5.725GHz band are restricted to indoor usage only.

IMPORTANT NOTICE:

FCC Radiation Exposure Statement:

This equipment complies with FCC radiation exposure limits set forth for an uncontrolled environment. This equipment should be installed and operated with minimum distance 20cm between the radiator & your body. To maintain compliance with FCC RF exposure compliance requirements, please avoid direct contact to the transmitting antenna during transmitting.

If this device is going to be operated in 5.15 ~ 5.25GHz frequency range, then it is restricted in indoor environment only. This transmitter must not be co-located or operating in conjunction with any other antenna or transmitter.

The availability of some specific channels and/or operational frequency bands are country dependent and are firmware programmed at the factory to match the intended destination. The firmware setting is not accessible by the end user.

ICC Notice:

Operation is subject to the following two conditions:

- 1) This device may not cause interference and
- 2) This device must accept any interference, including interference that may cause undesired operation of the device.

IMPORTANT NOTE:

IC Radiation Exposure Statement:

This equipment complies with IC radiation exposure limits set forth for an uncontrolled environment. End users must follow the specific operating instructions for satisfying RF exposure compliance. This equipment should be installed and operated with minimum distance 20cm between the radiator & your body.

This transmitter must not be co-located or operating in conjunction with any other antenna or transmitter.

- (i) The device for the band 5150-5250 MHz is only for indoor usage to reduce potential for harmful interference to co-channel mobile satellite systems;
- (ii) The maximum antenna gain (2dBi) permitted (for devices in the band 5725-5825 MHz) to comply with the e.i.r.p. limits specified for point-to-point and non point-to-point operation as appropriate, as stated in section A9.2(3).

In addition, users should also be cautioned to take note that high-power radars are allocated as primary users (meaning they have priority) of the bands 5250-5350 MHz and 5650-5850 MHz and these radars could cause interference and/or damage to LE-LAN devices.

Règlement d'Industry Canada

Les conditions de fonctionnement sont sujettes à deux conditions:

- (1) Ce périphérique ne doit pas causer d'interférence et.
- (2) Ce périphérique doit accepter toute interférence, y compris les interférences pouvant perturber le bon fonctionnement de ce périphérique.