

DNS-1550-04

Version 1.0

ShareCenter[®] Pro
4-Bay SMB Rack-mount
Unified Network Storage Enclosure

User Manual

Contents

Chapter 1: Introduction	5
1.1 About This Manual	5
1.2 Protocol Support	6
1.3 Hardware Specifications	6
1.4 Client Utility OS Support	7
1.5 Browser Support	7
Chapter 2: Quick Setting-up	9
2.1 Unpacking the ShareCenter® Pro DNS-1550-04	9
2.2 Installing Disk Drives	10
2.3 Connecting the Ethernet cable	13
2.4 Connecting the Power	13
2.5 Shutting Down the ShareCenter Pro DNS-1550-04	13
2.6 Setup Wizard	15
2.7 Replacement of Power Supply Units (PSU)	18
2.8 Replacement of Control Module	19
Chapter 3: WebPAM PROe	20
3.1 Quick Start	20
3.2 Dashboard Tab	22
3.2.1 System Status	22
3.2.2 Event Information	23
3.2.3 Storage Overview	23
3.3 Device Tab	25
3.3.1 Front View	25
3.3.2 Back View	26
3.3.3 Component List	27
3.3.4 Physical Drive	30
3.3.5 iSCSI	31
3.3.6 Network	33
3.3.7 UPS	36
3.3.8 External Drive	36
3.4 Storage Tab	38

3.4.1	Create Disk Array	39
3.4.2	Disk Array Management.....	43
3.4.3	Logical Drive Management	44
3.4.4	Spare Drive Management	47
3.5	AdminTool Tab	49
3.5.1	System settings and clearing statistics	49
3.5.2	Services	51
3.5.3	Runtime and NVRAM event logs	51
3.5.4	Background activity, settings and schedules	54
3.5.5	Firmware updates	60
3.5.6	Performance monitor	61
3.5.7	Restore factory default settings	63
3.5.8	Import/Export a system configuration file.....	64
3.5.9	LUNMap Management.....	65
3.5.10	Power Option	66
3.5.11	Message Alert	66
3.5.12	Network Security.....	67
3.6	NAS Tab.....	70
3.6.1	Setup Wizard.....	70
3.6.2	User account management.....	72
3.6.3	Protocol Control and Setting	74
3.6.4	File System Management	74
3.6.5	File Sharing Setting.....	75
3.6.6	Backup	78
3.6.7	Plug-in Management.....	85
3.6.8	iSCSI Initiator	86

Chapter 4: ShareCenter® NAVI..... 87

4.1	Working with ShareCenter® NAVI	87
4.1.1	Opening the Main Window	1
4.1.2	Choosing a ShareCenter® NAVI Language	89
4.1.3	Starting the Advanced Storage Manager	90
4.1.4	Viewing ShareCenter® NAVI Information	91
4.1.5	Closing ShareCenter® NAVI.....	93
4.2	Managing Backups	95
4.2.1	Doing a Backup Now	95
4.2.2	Scheduling a Backup	100
4.2.3	Viewing Backup Schedules.....	105
4.2.4	Changing a Scheduled Backup.....	105
4.2.5	Deleting a Scheduled Backup.....	108

4.2.6	Restoring Backed-up Files	109
4.2.7	Viewing the Backup Event Log	112
4.2.8	Saving the Event Log	113
4.2.9	Clearing the Event Log	115
4.2.10	Setting the Port	116
4.3	Managing Share Folders	117
4.3.1	Opening a Share Folder.....	117
4.3.2	Viewing a List of Share Folders	118
4.3.3	Mounting a Share Folder /Creating a Network Drive ...	120
4.3.4	Un-mounting a Share Folder /Disconnecting a Network Drive	121
4.3.5	Setting up a Share Folder for Time Machine	122
4.4	Making Management Settings	124
4.4.1	Configuring a NAS System	124
4.4.2	Locating the ShareCenter® Pro DNS-1550-04	129
4.4.3	Wake-on-LAN.....	1
4.4.3	Wake-on-LAN.....	130
4.4.4	Choosing a Default NAS System	130
4.4.5	Viewing the System Event Log	131
4.4.6	Viewing a List of Plug-ins.....	134
4.4.7	Viewing Plug-in Version Numbers.....	134
4.4.8	Enabling and Disabling Plug-ins	135
4.4.9	Removing Plug-ins.....	138
4.4.10	Rebooting the ShareCenter® Pro DNS-1550-04.....	139
4.4.11	Shutting Down the ShareCenter® Pro DNS-1550-04...	141
Chapter 5:	Troubleshooting.....	143
5.1	WebPAM PROe system event log	143
5.2	How to use USB Retrieval to export system information.....	154

Chapter 1: Introduction

1.1 *About This Manual*

This Product Manual describes how to setup, use, and maintain the ShareCenter® Pro DNS-1550-04. It also describes how to use:

- ShareCenter® NAVI software that you install and run on your Windows or Mac
- Advanced Storage Manager **WEBPAM PROe** software that runs on the ShareCenter® Pro DNS-1550-04 by browser.

This manual includes a full table of contents, chapter task lists, and numerous cross-references to help you find the specific information you are looking for.

Also included are four levels of notices:

Note

A Note Provides helpful information such as hints or alternative ways of doing a task.

Important

An Important calls attention to an essential step or point required to complete a task. Important items include things often missed.

Caution

A Caution informs you of possible equipment damage or loss of data and how to avoid them.

Warning

A Warning notifies you of Probable equipment damage or loss of data, or the possibility of physical injury, and how to avoid them.

1.2 Protocol Support

ShareCenter® Pro DNS-1550-04 series supports:

- SMB/CIFS for Microsoft Windows
- NFS for Linux/Unix
- AFP for Mac
- FTP
- WebDAV for the file transform over the Internet
- iSCSI Target model and Initiator model

1.3 Hardware Specifications

Model Name	DNS-1550-04(Dual PSU)
CPU	1.8 GHz
FLASH	256 MB
SDRAM	2GB DDRII
Smart Fan	Yes
Gigabit Ethernet	2
USB 2.0 Host port	5 (Front x 1/ Back x 4)
Internal HDD Support	3.5" 3 Gb/s SATAII
Hot Plug	Yes
# of Bays	4
Power Supply	226W*2 (80 PLUS)
Dimension	429(L) x 442(W) x 44(H) mm (16.9 x 17.4 x 1.7 inches)

1.4 Client Utility OS Support

The following operating systems support ShareCenter® NAVI:

- Windows® XP 32/64 Bit
- Windows Vista® 32/64 Bit
- Windows® Server 2003 32/64 Bit
- Windows® Server 2008 32/64 Bit
- Windows® Server 2008 R2
- Windows® 7 32/64 Bit
- Mac OS 10.5 and above
- Mac OS 10.6 XServer

1.5 Browser Support

Choose one of the following browsers to use with WEBPAM PROe:

- Internet Explorer 7 and above
- Firefox 3 and above
- Safari 5 and above
- Google Chrome 8 and above



Warning

The electronic components within the ShareCenter® Pro DNS-1550-04 are sensitive to damage from Electro-Static Discharge (ESD). Observe appropriate precautions at all times when handling the ShareCenter® Pro DNS-1550-04 or its subassemblies.



Important

To configure the ShareCenter® Pro DNS-1550-04, you are advised to install ShareCenter® NAVI. Please refer to the User Manual.



Warning

The fan contains hazardous moving parts. Keep fingers away.



Caution

RISK OF EXPLOSION IF BATTERY IS REPLACED BY AN INCORRECT TYPE.

CE:

WARNING

This is a class A Product. In a domestic environment this Product may cause radio interference in which case the user may be required to take adequate measures.

VCCI

この装置は、情報処理装置等電波障害自主規制協議会（VCCI）の基準に基づくクラスA情報技術装置です。この装置を家庭環境で使用すると電波妨害を引き起こすことがあります。この場合には使用者が適切な対策を講ずるよう要求されることがあります。

BSMI

警告使用者:

這是甲類的資訊產品，在居住的環境中使用時，可能會造成射頻干擾，在這種情況下，使用者會被要求採取某些適當的對策。

Chapter 2: Quick Setting-up

2.1 Unpacking the ShareCenter® Pro DNS-1550-04

The ShareCenter® Pro DNS-1550-04 series box contains the following items:

- ShareCenter® Pro DNS-1550-04 Unit
- *Quick Installation Guide*
- Screws for disk drives
- Ethernet cable
- Power cord
- CD for client utility and reference document

Figure 1. ShareCenter® Pro DNS-1550-04 Front View

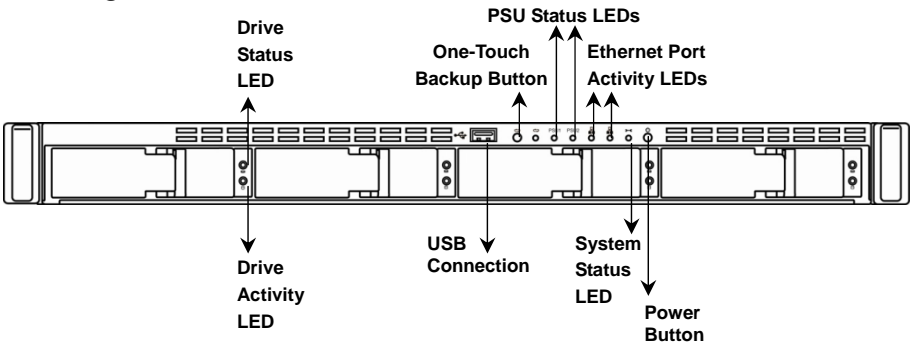
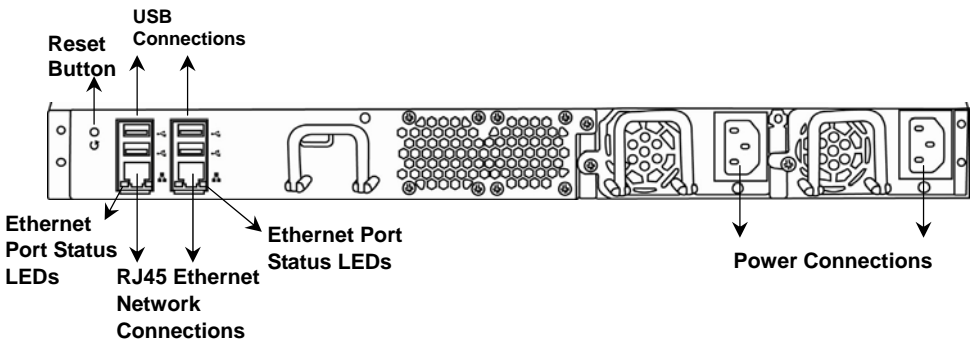

Figure 2. ShareCenter® Pro DNS-1550-04 Rear View



2.2 Installing Disk Drives

Note: It is highly recommended to select enterprise Level HDD to achieve the best data Protection.

You can populate the ShareCenter[®] Pro DNS-1550-04 series NAS with SATA 1.5 Gb/s or 3.0 Gb/s disk drives. For optimal performance, install disk drives of the same model and capacity. Your disk drives will become a RAID Volume on the ShareCenter[®] Pro DNS-1550-04.

To install disk drives:

1. Remove the disk tray from the device by the following steps:
 - a. Slide the latch leftwards.
 - b. Press the button next to the latch.
 - c. Pull the latch out to open the door of disk tray, then you can pull the disk tray out from the enclosure.

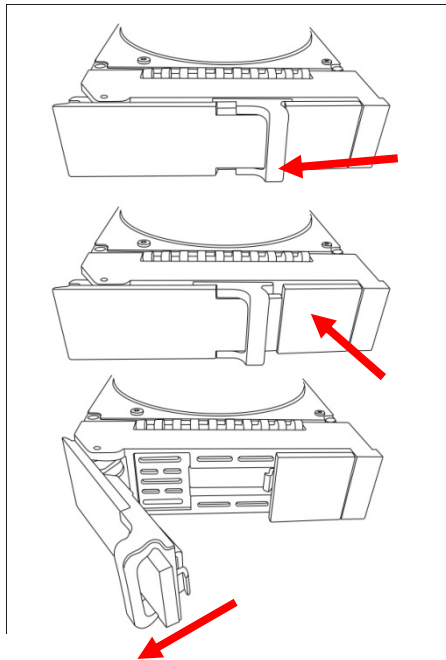

-
2. Carefully lay the disk drive into the drive tray, so that the screw holes on the sides of the carrier align with the screw holes in the drive.

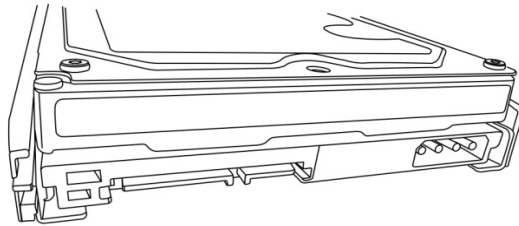
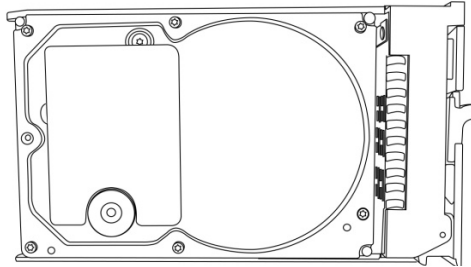

3. Insert the screws through the holes in the drive carrier and into the sides of the disk drive.
- Only install the countersunk screws supplied with the ShareCenter® Pro DNS-1550-04.
 - Install four screws per drive.
 - Snug each screw. Be careful not to over-tighten.

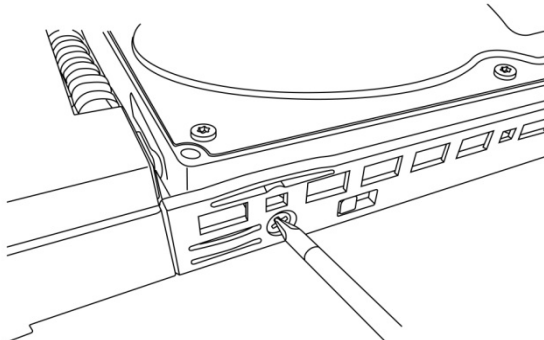

4. Reinstall the drive tray into the ShareCenter® Pro DNS-1550-04 enclosure.

Tip: Repeat steps 1 through 4 until all of your disk drives are installed.

2.3 Connecting the Ethernet cable

To connect the ShareCenter® Pro DNS-1550-04 to your network:

1. Attach one end of the network cable to the RJ45 network connection. See Figure 2.
2. Attach the other end of the network cable to your Ethernet hub or switch.

2.4 Connecting the Power

To power the ShareCenter® Pro DNS-1550-04:

1. Attach the two power cords to the dual power supplies of the ShareCenter® Pro DNS-1550-04 enclosure and plug the other ends into the power source. See Figure 2.
2. On the front of the ShareCenter® Pro DNS-1550-04, press the power button. See Figure 1. It takes about a minute to boot the ShareCenter® Pro DNS-1550-04. When fully booted:
 - The System Status LED turns blue. See Figure 1.
 - The buzzer beeps one time.

2.5 Shutting Down the ShareCenter Pro DNS-1550-04

To shut down the ShareCenter® Pro DNS-1550-04, press and hold the power button until the power LED indicator turns red. See Figures 3 and 4.

Figure 3. Press and hold the Power button about 5 seconds

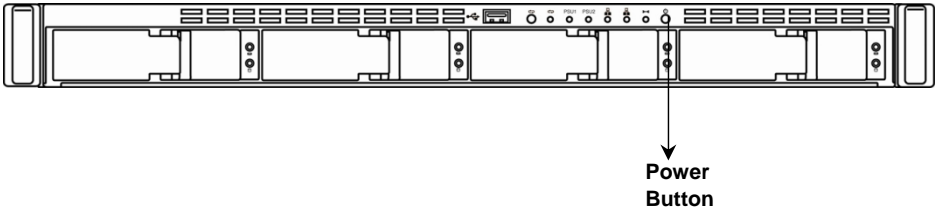
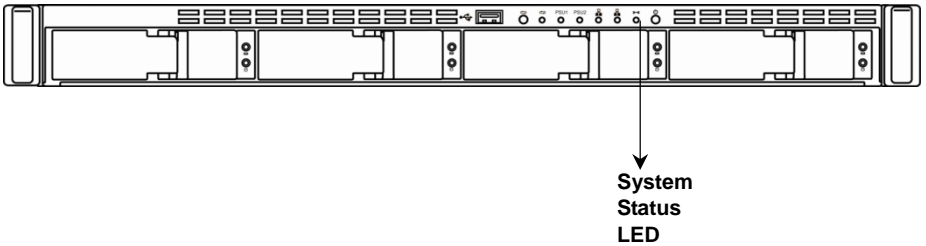

Figure 4. System status LED turns red, and then goes dark



To restart the ShareCenter[®] Pro DNS-1550-04, press the power button again.

2.6 Setup Wizard

You can quickly set up your DNS-1550-04 system through the WebPAMS PROe Wizard using either the **One-Click Setup** or using **Advanced-Setup**.

1. Quick Setup by Setup Wizard in WebPAM PROe

The system's Wizard in WebPAM PROe lets you configure your disk array(s) easily and quickly. The Wizard will guide you through the required settings step by step. You can choose to configure automatically by using **One-Click Setup**, or configure manually by using **Advance Setup**.

2. How to use Automatic Configuration Wizard?

- Connect to the WebPAM PROe through your browser.
(Following steps below to log in Web-based configuration manager)
- 2.1. Start your browser (IE7 or above, FireFox 3 or above, Google Chrome).
- 2.2. On the URL address bar, type in the default IP address <http://192.168.0.32>, The login screen will appear:



- 2.3. Select "Admin" and type default password "**password**"
- 2.4. Choose preferred language by clicking the **Language** menu.

- Click **NAS** tab > **Wizard**.



- Click the One-Click Setup button. The Automatic Configuration box displays:

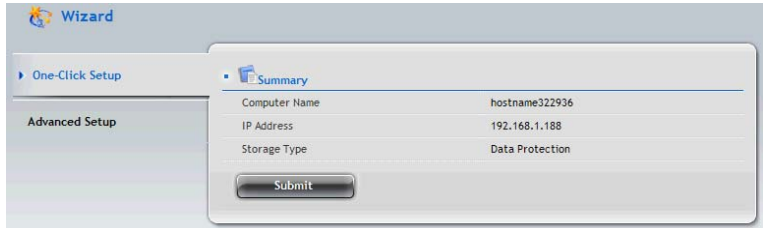

- The Summary window displays the general information of the system, including:
 - Computer Name
 - IP Address
 - Storage Type
- To accept the proposed configuration, click the Submit button.

If you disagree with the proposed configuration, click the **Advanced Setup** button to directly specify all parameters for a new disk array, logical drives, and spare drives.

Using Advanced Configuration Wizard

1. Click **NAS** tab > **Wizard**.
2. Click the **Advanced Setup** button. The Advanced Configuration box displays:

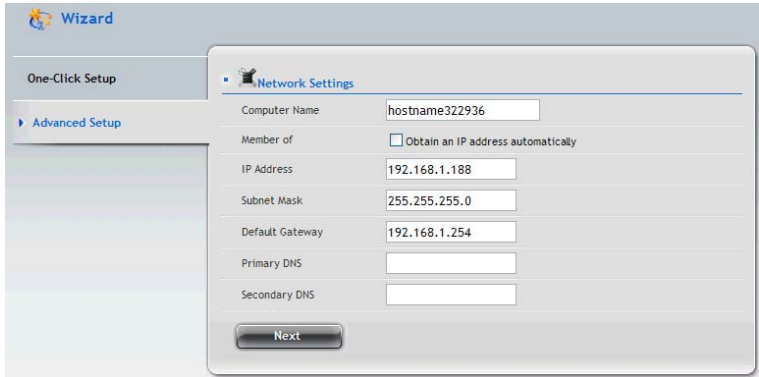

3. Complete the required settings in the Network Settings window, including:
- Computer Name
 - Obtain an IP address automatically
 - IP Address
 - Subnet Mask
 - Default Gateway
 - Primary DNS
 - Secondary DNS

When done, click the **Next** button.

4. Select Storage Type: Data Protection or Maximum Capacity, and then click the **Next** button.
5. The Summary window displays the general information of the system, including:
 - Computer Name
 - IP Address
 - Storage Type

To accept the proposed configuration, click the **Submit** button.

2.7 Replacement of Power Supply Units (PSU)

The DNS-1550-04 supports two hot-swappable PSUs. You may swap either of the PSUs one at a time if an uninterruptable power supply is in use.

Step 1. Loosen screw (A) on PSU to be replaced.

Step 2. Remove the PSU by pulling on the handle.

Step 3. Insert the new PSU.

Step 4. Tighten screw (A).

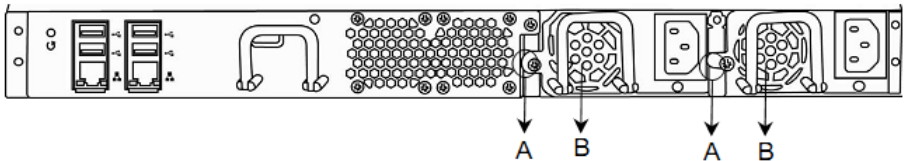

2.8 Replacement of Control Module

When the system controller malfunctions, you may replace the control module as per following steps:

Step 1. Please turn off the system power.

Step 2. Loosen screw (A) on the control module.

Step 3. Remove the controller by pulling on the handle.

Step 4. Insert the new controller.

Step 5. Tighten screw (A).

Step 6. Reboot the system.

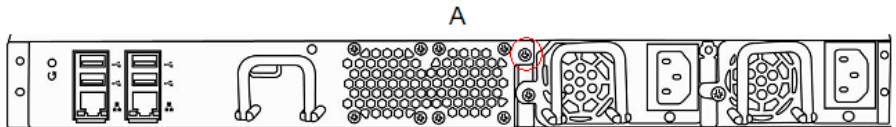

Chapter 3: WebPAM PROe

3.1 Quick Start

The WebPAM PROe is factory-installed on the ShareCenter® Pro DNS-1550-04 system. WebPAM PROe runs in the browser on your PC/Mac. You can access WebPAM PROe by using your browser.

Browser Support

Choose one of the following browsers to use with WebPAM PROe:

- Internet Explorer 7 or above
- Firefox 3 and above
- Safari 5 and above
- Google Chrome

Connecting to WebPAM PROe

To log into WebPAM PROe from your browser:

1. Start your browser.
2. In the URL address bar, type in the IP address of the ShareCenter® Pro DNS-1550-04. (Default IP Address: 192.168.0.32)

The WebPAM PROe login screen displays.



-
- The default user name is “administrator” and default password is “password”
(The user name and password are case sensitive).
 - Choose the language you prefer by clicking the **Language** menu on the login screen.

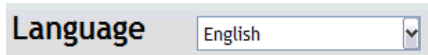

- To log out of WebPAM PROe, you can do either of the following:
 - Close your browser window.
 - Click Logout in the WebPAM PROe Header.

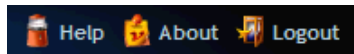

Clicking **Logout** brings you back to the Login Screen. After logging out, you must enter your user name and password in order to log in again.

Navigating in WebPAM PROe

The five tabs displayed on the screen are the primary navigation tools found in WebPAM PROe. Categories of functions are listed below the icon found on each tab.



Icons for specific functions are listed on each tab. Click the icon/tab to show the functions offered.
Click the function's icon to display its information on the screen.

3.2 Dashboard Tab

The **Dashboard** tab is the default screen of WebPAM PROe.

The screenshot shows the ShareCenter Pro Dashboard interface. At the top, there is a navigation bar with icons for Dashboard, Device, Storage, AdminTool, and NAS. The main content area is divided into three sections:

- System Status:** A vertical list of components with status indicators. A red shield icon at the top indicates "This system has encountered errors!". Components include Controller (OK), Voltage (OK), Temperature (OK), PSU (Warning), Cooling Unit (OK), Disk Array (OK), Logical Drive (OK), Physical Drive (OK), Spare Drive (OK), File System (OK), and Firmware (OK).
- Event Information:** A table listing recent events.

Device	Severity	Time	Description
PSU 1 Enc 1	Warning	May 15, 2011 05:58:12	PSU has been removed
Port 1 Ctr1 1	Info	May 15, 2011 05:57:22	Host interface link is up
Port 1 Ctr1 1	Info	May 15, 2011 05:57:21	Host interface link is down
Port 1 Ctr1 1	Info	May 15, 2011 05:57:07	Host interface link is up
Ctr1 1	Info	May 15, 2011 05:56:55	The system is started
- Storage Overview:** A pie chart showing storage capacity. Total Physical Capacity is 927.60 GB. Unconfigured: 0 Bytes. Configured: 927.60 GB. A table lists the number of present devices:

Device	Number Present
Controllers	1
Disk Arrays	1
Logical Drives	2
Physical Drives	4
Spare Drives	1

The System Status icon indicates the top-level status of the NAS by displaying:



system is OK



system has errors

3.2.1 System Status

The System Status field displays the status of the NAS components by means of the following icons:



the component is OK



the component needs attention



the component has failed

To view the status of each component, click the following tab and topic sequence. A status screen will then be displayed:

- **Controller** (RAID controllers)
Device tab > Component List.
- **Voltage**
Device tab > Component List.
- **Temperature** (RAID and JBOD enclosures only)
Device tab > Component List.
- **PSU** (Power supply unit. RAID and JBOD enclosures only.)
Device tab > Component List.
- **Cooling Unit** (RAID and JBOD enclosures only.)
Device tab > Component List.
- **Disk Array**
Storage tab > Disk Array.
- **Logical Drive**
Storage tab > Logical Drive.
- **Physical Drive**
Device tab > Physical Drive List.
- **Spare Drive**
Storage tab > Spare Drive.
- **File System**
NAS tab > File System.
- **Firmware**
AdminTool tab > Firmware Update.

3.2.2 Event Information

The Event Information field displays six of the most recent Runtime events. Click **More** to display the **AdminTool tab > Runtime Events** screen, allowing you to view all Runtime and NVRAM events.

3.2.3 Storage Overview

The Storage Overview field displays the general information of the current storage status, including:

- **Total Physical Capacity.** Display the total storage space of the system.
 - **Unconfigured** – not assigned to a logical drive.
 - **Configured** – assigned to a logical drive.
- **Device Number.** Display the current number of devices in the system.

3.3 Device Tab

The Device tab displays the status of all devices in the NAS including physical drives, disk arrays, logical drives, power supply units, fans and backplanes.

In the Device tab, you can change settings for the enclosure and physical drives.



3.3.1 Front View

Click **Device tab > Front View** to view all of the enclosures found in your NAS network. Move your mouse over the drive carrier to display the information of the installed physical drive (as show below), including the device ID, physical capacity, operational status, etc. Click on the drive to bring up the Physical Drive Information, displaying the detailed information of the device.



Identifying Unconfigured Physical Drives

Click the **Show unconfigured PD(s)** box to identify the unconfigured physical drives in the NAS.

Identifying Physical Drives Assigned to a Disk Array

Click the **Highlight Arrays** button to identify the physical drives assigned to a disk array.

Click on one of the following items in the dropdown menu:

- **All DA** – all disk arrays
- **DA0 (DA1, DA2, etc.)** – a specific disk array
- **Close** – click to close the menu and return to normal view.

The carriers containing drives that do not belong to the chosen disk array will be highlighted.

3.3.2 Back View

Click **Device** tab > **Back View** to display the back view of all enclosures in the NAS. Move your mouse over the power supply and I/O units to view the PSU status and the operational status of the devices through the I/O units. Click **Show Internal Components** to display the virtual view of the internal components (as shown below).

Move your mouse over the component and the related information will be displayed:

- **CPU** – CPU usage
- **Controller thermometer** – temperature of the controller board
- **Temperature of the system**
- **RAM** – memory usage
- **Enclosure information**



3.3.3 Component List

Click **Device** tab > **Component List** to display the device ID, operational status, enclosure type, and status description of all enclosures.

ID	Type			
Enclosure 1	DNS-1550-04			
Enclosure				
ID	Status	Type	Status Description	
1		DNS-1550-04	1 PSU(s) critical	
Controller				
ID	Status	Alias	Operational Status	Readiness Status
1			OK	Active
Buzzer				
ID	Enable	Status		
1	Enabled	Silent		
LED				
ID	Status			
1	Always ON			
Fan				
ID	Service			
1	Automatic			

- **Enclosure**

- **View:** Move your mouse over the enclosure you want and click the **View** button to display the enclosure information list.
- **Setting:** Set the system critical warning/critical temperature.
- **Locate:** The system will make a buzzing sound.

- **Controller**

- **View:** Move your mouse over the controller you want and click the **View** button to display the controller information list.
- **Setting:**
 1. Move your mouse over the controller you want and click the **Settings** button.
 2. Make setting changes as required:
 - Enter, change or delete the alias in the Alias field
 - Enable SMART Log – Check the box to enable or uncheck to disable
 - SMART Polling Interval – Enter a value into the field, 1 to 1440 minutes
 - HDD Power Levels
 - Level 0: Disabled

- Level 1: Park R/W heads
- Level 2: Slow down (need to be supported by hard drive)
- Level 3: Spin down
- Spin Down Type
- Power Saving Idle Time
- Power Saving Standby Time
- Power Saving Stopped Time
- **Enable Coercion:**
 - This feature is designed for fault-tolerant logical drives (RAID 0, 1, 5, 6, and 10). It is generally recommended to use physical drives of the same size in your disk arrays. When this is not possible, physical drives of different sizes will work but the system must adjust for the size differences by reducing or coercing the capacity of the larger drives to match the smaller ones. You can choose to enable Capacity Coercion and any one of four methods.
 - Capacity Coercion also affects a replacement drive used in a disk array. Normally, when a physical drive fails, the replacement drive must be the same capacity or larger. However, the Capacity Coercion feature permits the installation of a replacement drive that is slightly smaller (within 1 gigabyte) than the remaining working drive. For example, the remaining working drives can be 80.5GB and the replacement drive can be 80.3, since all are rounded down to 80GB. This permits the smaller drive to be used.
 - Without Capacity Coercion, the controller will not permit the use of a replacement physical drive that is slightly smaller than the remaining working drives.
- **Coercion Method** – Choose a method from the dropdown menu:
 - **GB Truncate** – (Default) Reduce the useful

capacity to the nearest 1,000,000,000 byte boundary.

- **10GB Truncate** – Reduces the useful capacity to the nearest 10,000,000,000 byte boundary.
- **Group Rounding** – Uses an algorithm to determine how much to truncate. Results in the maximum amount of usable drive capacity.
- **Table Rounding** – Applies a predefined table to determine how much to truncate.

- Write Back Cache Flush Interval – Enter a value into the field, 1 to 12 seconds
- Phydrv Driver Temperature Threshold
- Enclosure Polling Interval
- Adaptive Writeback Cache:
 - UPS power good: write back
 - UPS power fail: write through
 - No UPS: write through
- Host Cache Flushing
- Forced Read Ahead (cache) – Check the box to enable or uncheck to disable

3. Click the **Save** button.

● **Buzzer**

- Click the **Sound** button to unmute the buzzer; or click the **Mute** button to mute the buzzer.
- Click the **Settings** button to enable or disable the buzzer. To enable the buzzer for the system, select the **Enable Buzzer** option and click the **Save** button. To mute the buzzer for all events, you must clear the **Enable Buzzer** option.

● **LED.** Move your mouse over the LED and click the **Settings** button, which allows you to set the LED by selecting:

- **Always ON**
- **Always OFF**
- **Daily**

● **Fan.** Move your mouse over the Fan and click the **Settings** button, which allows you to set the LED by selecting:

- **Manual**
- **Automatic**

When done, click the **Save** button.

3.3.4 Physical Drive

Click **Device** tab > **Physical Drive** to display the list of physical drives in the NAS. Physical drive information includes:

- ID – ID number of the physical drive
- Status – Green, yellow, and red icons
- Model – Make and model of the drive
- Type – SATA HDD
- Location – Enclosure number and slot number
- Configuration – Array number and sequence number, spare number, unconfigured, or stale configuration
- Capacity – The capacity of drive

Viewing Physical Drive Information

1. Click **Device** tab > **Physical Drive**.
2. Move you mouse over the physical drive you want and click the **View** button.

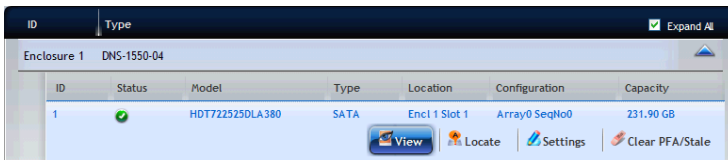

The screenshot shows a table with columns: ID, Status, Model, Type, Location, Configuration, and Capacity. A single row is visible with a green status icon. Below the table are buttons for View, Locate, Settings, and Clear PFA/Stale.

ID	Status	Model	Type	Location	Configuration	Capacity
1		HDT722525DLA380	SATA	Encl 1 Slot 1	Array0 SeqNo0	231.90 GB

Display all Physical drive information.

To locate the physical drive:

1. Click **Device** tab > **Physical Drive**.
2. Move your mouse over the physical drive you want and click the Locate button.
3. The drive carrier LEDs blink for one minute.

To change the global physical drive settings:



1. Click **Device** tab > **Physical Drive**.
2. Click the **Global Physical Drive Settings** button.

-
3. In the Global Physical Drive Settings window, check the boxes to enable or uncheck to disable.
 - Enable Write Cache
 - Enable Read Look Ahead Cache
 - Enable Command Queuing

To change the individual physical drive settings:

1. Click **Device** tab > **Physical Drive**.
2. Move your mouse over the physical drive you want and click the **Settings** button.
3. Make setting changes as required: enter, change, or delete the alias in the Alias field.
4. Click the **Save** button.

Physical Drive Problems:

Physical drives are the foundation of data storage. A physical drive Problem can affect your entire NAS. When a yellow  icon or a red  icon appears beside a physical drive, check the drive's operational status:

1. Click **Device** tab > **Physical Drive**.
2. Move your mouse over the physical drive you want and click the **View** button.
3. Check the status of the Operational Status item.

3.3.5 iSCSI

Click **Device** tab > **iSCSI** to display the iSCSI (Internet Small Computer System Interface) information in the system. iSCSI information includes the following tabs:

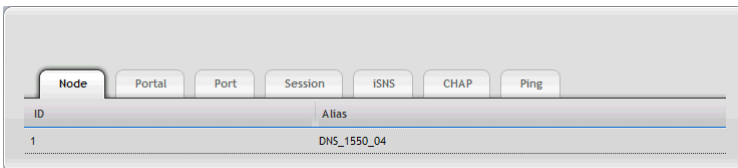

- Node
- Portal
- Port
- Session

- iSNS
- CHAP
- Ping

Setting up CHAP

1. Click **Device** tab > **iSCSI** > **CHAP** tab.
2. Move your mouse over the item you want and click the **Setting** button.

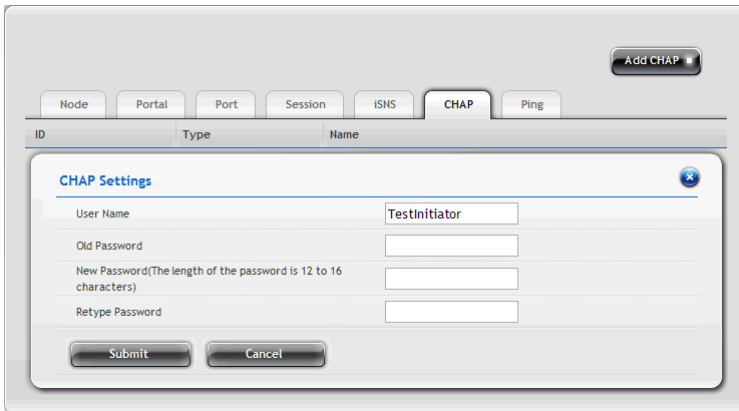

3. Complete the required settings in the **Chap Settings** window, and then click the **Submit** button.
 - User Name
 - Old Password
 - New Password
 - Retype Password

Click the  button to close the dialog window.

3.3.6 Network

Click **Device** tab > **Network** to display the networking information of the system.

ID	DHCP	IP Address	Gateway IP Address	Speed	MTU	Link
1	No	192.168.1.188	192.168.1.254	100 Mps	1500byte (s)	Yes

TCP/IP | IPV6

Networking information includes:

- ID
- DHCP
- IP Address
- Gateway IP Address
- Speed
- MTU
- Link

Changing Networking Configuration

1. Click **Device** tab > **Network**.
2. Move your mouse over the network you want and click the **TCP/IP** (or **IPV6**) button.
3. Complete the required settings in the dialog window, and then click the **Submit** button.
 - Network Speed – Select the networking speed from the menu.
 - IP Properties
 - IP Address
 - Subnet Mask
 - Gateway IP Address
 - DNS Server IP Address
 - Secondary DNS Server IP Address

Click the  button to close the dialog window.

Advanced Networking Configuration

1. Click **Device** tab > **Network**.
2. Click the **Setup** button.

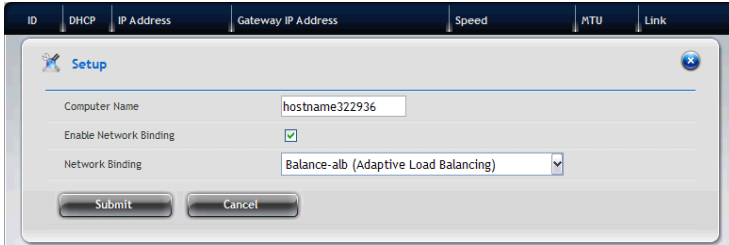

3. Complete the required settings in the **Setup** window, and then click the **Submit** button.
 - Computer Name
 - Enable Network Binding – Choose to enable or disable a bidding.
 - Networking Binding – From the dropdown menu, choose a Proper bidding type.Click the  button to close the dialog window.

Setting up DHCP Server

1. Click **Device** tab > **Network**.
2. Click the **DHCP Server** button.

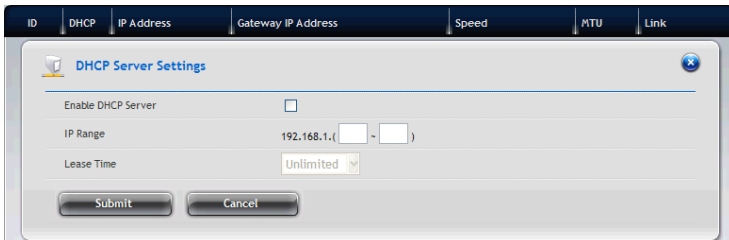

-
3. Complete the required settings in the **DHCP Server Settings** window, and then click the **Submit** button.

- Enable DHCP Server – Choose to enable or disable the function.
- IP range – Assign the IP range in the text boxes.
- Lease Time

Click the  button to close the dialog window.

Setting up DDNS

1. Click **Device** tab > **Network**.
2. Click the **DDNS** button.



3. Complete the required settings in the **DDNS Settings** window, and then click the **Submit** button.

- Enable DDNS – Choose to enable or disable the function.
- DDNS Server – Enter the address of the DDNS server.
- Host Name – Enter the host name of the DDNS server.
- User Name – Enter the user name to login the DDNS server.
- Password – Enter the password to login the DDNS server.

Click the  button to close the dialog window.

3.3.7 UPS

Click **Device** tab > **UPS** to display the information of the connected UPS in the system.

Setting up UPS



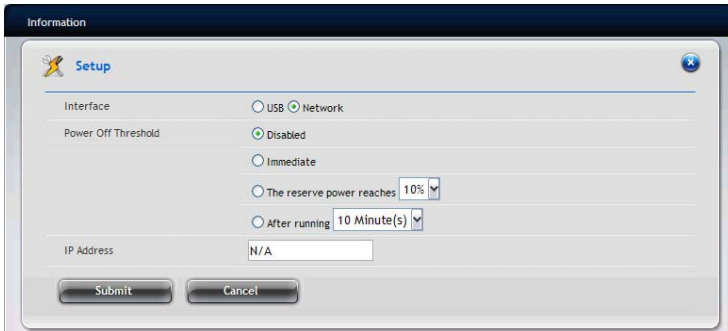

1. Click **Device** tab > **UPS**.
2. Click the **Setup** button to bring up the Setup window.
3. Select the option you want and complete the required settings, and then click the **Submit** button.



Click the  button to close the dialog window.

3.3.8 External Drive

Click **Device** tab > **External Drive** to display the information of the connected external drive in the system.

ID	Status	Model	Type	Location	Total Capacity	Cache	
4	Connected	USB DISK 2.0	USB	Port 4	7.46 GB	Write Through	
							

External drive information includes:

- ID
- Status
- Model
- Type
- Location
- Total Capacity

-
- Cache

ShareCenter Pro DNS-1550-04 can support external file system as below:
EXT3, XFS, FAT32, NTFS, HFS+

Warning!

To remove the connected USB drive safely, you **MUST** click the **Remove** button before disconnecting the USB drive.

Managing the External Drive

1. Click **Device** tab > **External Drive**.
2. Move your mouse over the external drive you want, and then you can do one of the following:
 - Click the **Settings** button and select the Write Policy (Write Through or Write Back), and then click the **Save** button to configure the external drive.
 - Click the **Format** button and select the format type (FAT32, ntfs, or xfs), and then click the **Format** button to format the external drive.
 - Click the **Remove** button and click the **Confirm** button to remove the external drive.

Click the  button to close the dialog window.

3.4 Storage Tab

The **Storage** tab enables you to create, manage, and delete disk arrays, logical drives, and spare drives.

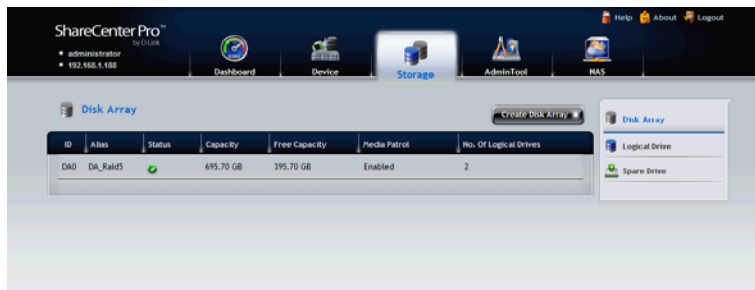

The list of Disk Array Provides the information of the disk array, including:

- ID – DA0, DA1, DA2, etc.
- Alias – If assigned.
- Status – Green, yellow or red icon.
- Capacity – Data capacity of the disk array.
- Free Capacity – Unconfigured or unused capacity on the physical drives.
- Media Patrol – Enabled or disabled on this disk array.
- No. Of Logical Drives – The number of logical drives on this disk array.

To initialize the Dsk Array:

Initialization is normally done to logical drives after they are created from a disk array. Initialization sets all data bits in the logical drive to zero. The action is useful because there may be residual data on the logical drives left behind from earlier configurations. For this reason, Initialization is recommended whenever you create a logical drive.

Step 1. Create Disk Array. Refer to the instructions in section 3.4.1.

Step 2. Create Logical Drive. Refer to the instructions in section 3.4.4.

Step 3. Create File System.

Warning!

When you initialize a logical drive, all the data on the logical drive is lost. Backup any important data before you initialize a logical drive.

3.4.1 Create Disk Array

You can also use the Wizard to create a disk array with logical drives and spare drives at the same time.

To create a disk array:

1. Click **Storage tab > Disk Array**.
2. Click the **Create Disk Array** button.
3. In the Create Disk Array window, complete the required settings:

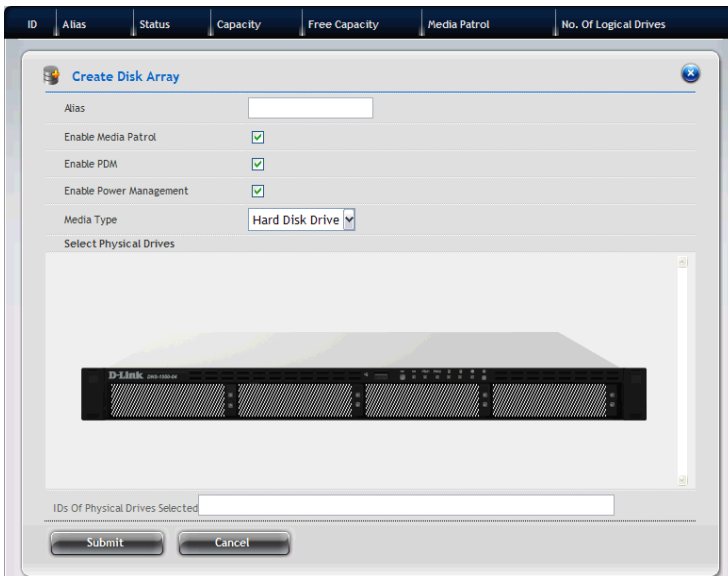

- In the **Alias** field, enter an alias at a maximum of 32 characters (includes letters, numbers, space between characters, and underline).
- Select the **Enable Media Patrol** option to enable the function on this disk array; otherwise, clear this option to disable.
- Select the **Enable PDM** option to enable the function on this disk array; otherwise, clear this option to disable.
- Select the **Enable Power Management** option to enable the

function on this disk array; otherwise, clear this option to disable.

4. In the **Select Physical Drives** diagram, click the drives to add them to your disk array. The ID numbers of the selected drives will appear in the field below the diagram.
5. When done, click the **Submit** button. The new disk array appears in the list.
6. Do one of the following:
 - To create additional disk arrays, click the **Create More** button.
 - If you are done creating disk arrays, click the **Finish** button.

After creating a disk array, you need to create a logical drive on it. Follow the steps below to create a logical drive:

1. Click **Storage tab > Logical Drive**.
2. Click the **Create Logical Drive** button.
3. Select the disk array you want to use and click the Next button.

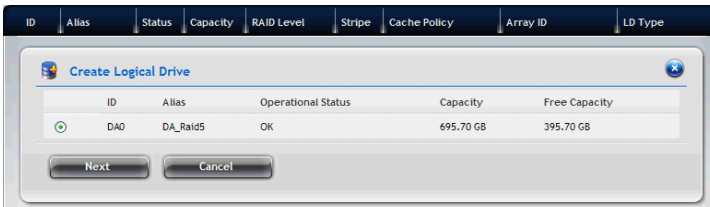

4. In the Create Logical Drive window, complete the required settings:

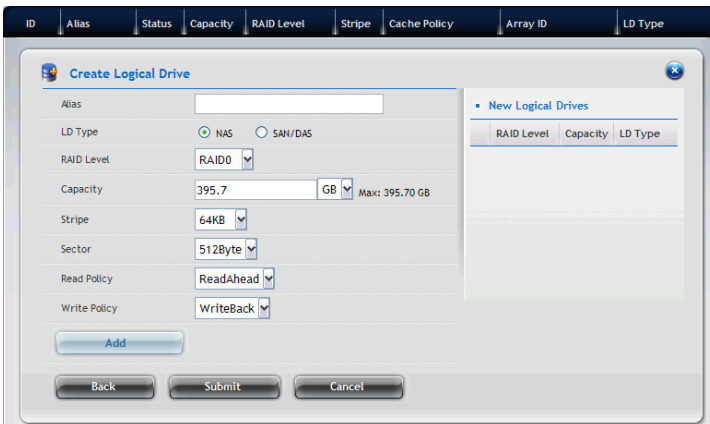

- In the **Alias** field, enter an alias at a maximum of 32

characters (includes letters, numbers, space between characters, and underline).

- Set the **LDType** as **NAS** or **SAN/DAS**.
- Select a **RAID Level** from the dropdown menu, depending on the number of physical drives in the disk array.
Support RAID type with drive number

	1	2	3	4	5	6
RAID0	●	●	●	●	●	●
RAID1		●				
RAID10				●		
RAID1E		●	●	●	●	●
RAID3			●	●	●	●
RAID30						●
RAID5			●	●	●	●
RAID50						●
RAID6				●	●	●

- In the **Capacity** field, accept the default maximum capacity or enter a lesser capacity (size in MB, GB or TB). Any remaining capacity is available for an additional logical drive.
 - Choose the **Stripe** size: 64 KB, 128 KB, 256 KB, 512 KB, or 1 MB.
 - Choose the **Sector** size: 512 B, 1 KB, 2 KB, or 4 KB.
 - Choose the **Read Policy**: Read Cache, Read Ahead, or No Cache
 - Choose the **Write Policy**: Write Back or Write Through.
5. Click the **Add** button. The new logical drive appears in the **New Logical Drives** list.
- If there is capacity remaining, you can create an additional logical drive.
6. When done, click the **Submit** button. The new logical drive(s) will appear in the **Logical Drive** list.

New logical drives are automatically synchronized. You can access the logical drive during synchronization.

Disk Array Problems:

Disk array Problems typically result from a physical drive failure. The most

common Problem is a degraded disk array. The RAID controller can rebuild a degraded disk array.

A more serious, but far less common Problem is an Incomplete Array. An incomplete array results from a physical drive that fails or becomes missing during:

- RAID level migration
- Disk array transport

Disk Array Degraded:

Disk arrays are made up of physical drives. Logical drives are created on the disk array. When one of the physical drives in a disk array fails:

- The operational status of disk array becomes Degraded.
- The operational status of logical drives becomes Critical.
- The operational status of physical drive becomes Dead or Offline.

Disk Array Offline:

Disk arrays are made up of physical drives. Logical drives are created on the disk array. When a disk array and its logical drives go **Offline**, the data stored in the logical drives is no longer accessible.

- Logical drives based on fault-tolerant disk arrays — RAID 1, 5, 6 and 10,— go Offline when two physical drives are removed or fail.
- Logical drives based on non-fault tolerant disk arrays — RAID 0 — go Offline when a one physical drive is removed or fails.

3.4.2 Disk Array Management

1. Click **Storage** tab > **Disk Array**. The list of disk arrays appears.
2. Move your mouse over the disk array you want to display the options of the disk array, including:

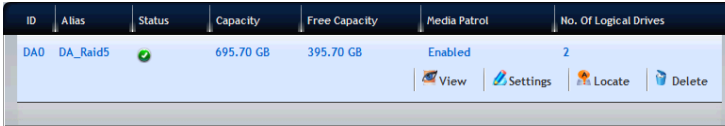

ID	Alias	Status	Capacity	Free Capacity	Media Patrol	No. Of Logical Drives
DA0	DA_Raid5		695.70 GB	395.70 GB	Enabled	2

- **View** – Select to view disk array status in the Information tab:
 - Disk Array ID – DA0, DA1, DA2, etc.
 - Alias – If assigned
 - Operational Status – OK is normal
 - Media Patrol – Enabled or disabled on this array
 - PDM – Enabled or disabled on this array
 - Power Management
 - Total Physical Capacity – Data capacity of the array
 - Configurable Capacity – Maximum usable capacity of the array
 - Free Capacity – Unconfigured or unused capacity on the physical drives
 - Max Contiguous Free Capacity – Unconfigured or unused capacity in contiguous sectors on the physical drives
 - Number of Physical Drives – The number of physical drives in this array
 - Number of Logical Drives – The number of logical drives on this array
- **Settings** – Select to change or delete the alias in the Alias field. Also, you can enable or disable Media Patrol, PDM, and Power Management. When done, click the **Save** button.
- **Locate** – This feature causes the drive carrier’s LED to blink for one minute to assist you in locating the physical drives that make up this disk array.
- **Delete** – Select and click the **Confirm** button to delete a disk array.

CAUTION: IF YOU DELETE A DISK ARRAY, YOU ALSO DELETE LOGICAL DRIVES THAT BELONG TO IT, ALONG WITH THE DATA IN THOSE LOGICAL DRIVES. BACK UP IMPORTANT DATA BEFORE DELETING A DISK ARRAY.

3.4.3 Logical Drive Management

1. Click **Storage tab > Logical Drive**. The list of logical drives appears.
2. Move your mouse over the logical drive you want to display the options of the logical drive, including:

ID	Alias	Status	Capacity	RAID Level	Stripe	Cache Policy	Array ID	LD Type
LD0	LD1_NAS		100 GB	RAID5	64 KB	ReadAhead/WriteBack	DA0	NAS

View Settings Check Table Locate Delete

- **View** – Select to view logical drive status:
 - Disk Array ID – LD0, LD1, LD2, etc.
 - Alias – If assigned
 - Array ID – ID number of the disk array where this logical drive was created
 - RAID Level – Set when the logical drive was created
 - Operational Status – OK means normal
 - Capacity – Data capacity of the logical drive
 - Number of Axles – For RAID 10, 2 axles. For RAID 50 and 60, 2 or more axles
 - Physical Capacity – Data capacity of the physical drives
 - Number of Physical Drives – The number of physical drives in the disk array
 - Stripe size – Set at logical drive creation
 - Read Policy – Adjustable
 - Sector size – Set at logical drive creation
 - Write Policy – Adjustable
 - Tolerable Number of Dead Drives – Number of physical drives that can fail without the logical drive going offline
 - Synchronized – A new logical drive shows "No" until synchronizing is completed
 - Parity Pace – Pertains to some RAID levels

-
- WWN – World Wide Number, a unique identifier assigned to this logical drive
 - Codec Scheme – Pertains to some RAID levels
 - Serial Number – Assigned to this logical drive
 - ALUA Access State For Ctrl1
 - ALUA Access State For Ctrl2
 - LDType – Displays the LD type of the logical drive.
 - **Settings** – Select to change or delete the alias in the Alias field. Also, you can configure the Read Policy (ReadCache, ReadAhead, or NoCache) and Write Policy (WriteThru or WriteBack). When done, click the **Save** button.
 - **Check Table** – Displays the error tables. Use this information to evaluate the integrity of the logical drive and to determine whether corrective action is needed.

Choose an option:

- All – All errors. The default choice.
- Read Check – Read errors for this logical drive.
- Write Check – Write errors for this logical drive.
- Inconsistent Block – Inconsistent blocks for this logical drive. Mirror data for RAID Levels 1, 1E and 10 or Parity data for RAID Levels 5, 6, 50, and 60. Identified by the Redundancy Check.

The Check Table lists:

- Entry Number – A number assigned to each block of entry.
- Table Type – Read Check, Write Check or Inconsistent Block.
- Starting Logical Block Address – LBA of the first block for this entry.
- Count – Number of errors or continuous blocks starting from this LBA.
- **Locate** – This feature causes the drive carrier's LED to blink for one minute to assist you in locating the physical drives that make up this disk array.
- **Delete** – Select and click the **Confirm** button to delete a logical.

CAUTION: IF YOU DELETE A LOGICAL DRIVE, YOU ALSO DELETE ALL THE DATA IN THE LOGICAL DRIVE. BACK UP IMPORTANT DATA BEFORE DELETING A LOGICAL DRIVE.

To run Redundancy Check on a logical drive:

1. Click **AdminTool** tab > **Background Activity**. The list of background activities appears.
2. Move your mouse over the Redundancy Check item and click the **Start** button.

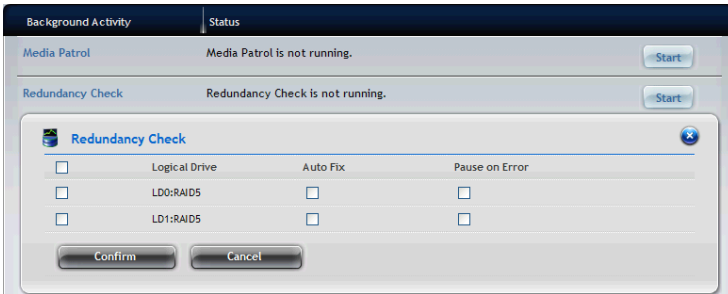

3. Check the boxes to the left of the logical drives you want to run.
4. Check the options you want:
 - Auto Fix – Attempts to repair the Problem when it finds an error
 - Pause on Error – The Process stops when it finds a non-repairable error
5. Click the **Confirm** button.

To change the Synchronization settings:

1. Click **AdminTool** tab > **Background Activity**.
2. Click the **Settings** button.
3. Click the Background Synchronization Rate dropdown menu and choose a rate:
 - Low – Fewer system resources to Synchronization, more to data read/write operations.
 - Medium – Balances system resources between Synchronization and data read/write operations.

-
- High – More system resources to Synchronization, fewer to data read/write operations.

4. Click the **Confirm** button.

Logical Drive Problems:

Logical drive Problems typically result from a physical drive failure. The most common Problem is a critical logical drive. The RAID controller can rebuild a critical logical drive.

A more serious but far less common Problem is an Incomplete Array. An incomplete disk array results from a physical drive that fails or becomes missing during:

- RAID level migration
- Physical drive transport

3.4.4 Spare Drive Management

If you have an unassigned disk drive, you can assign it as a spare drive. A spare is a disk drive that has been designated to replace a failed disk drive in a RAID Volume. In the event of the failure of a disk drive within a RAID 1 or three drive RAID 5 Volume, the spare drive is activated as a member of the RAID Volume to replace a disk drive that has failed.

A spare drive cannot replace the failed drive in a RAID 0 Volume because of the way in which data is written to the disk drives under RAID 0. A spare drive is not available for a RAID 10 Volume because RAID 10 requires all four disk drives in the ShareCenter® Pro DNS-1550-04 enclosure. However, when you replace the failed disk drive, the ShareCenter® Pro DNS-1550-04 will automatically rebuild the RAID Volume using the new disk drive.

To assign a spare drive:

1. Click **Storage** tab > **Spare Drive**. The list of spare drives appears.
2. Move your mouse over the spare drive you want to display the options of the spare drive, including:

ID	Status	Capacity	Physical Drive ID	Revertible	Type	Dedicated to Array
Spare0		232.89 GB	PD4	Yes	Global	

View Settings Spare Check Delete

– ID

- Status – Green, yellow or red icon.
 - Capacity – Data capacity of the spare drive.
 - Physical Drive ID
 - Revertible
 - Type
 - Dedicated to Array
3. When done, click the **Confirm** button.

3.5 AdminTool Tab

The **AdminTool** tab enables you to manage the Subsystem NAS system or virtual enclosure, monitor events, manage background activities, perform firmware updates, restore factory default settings, and save a NAS configuration report.

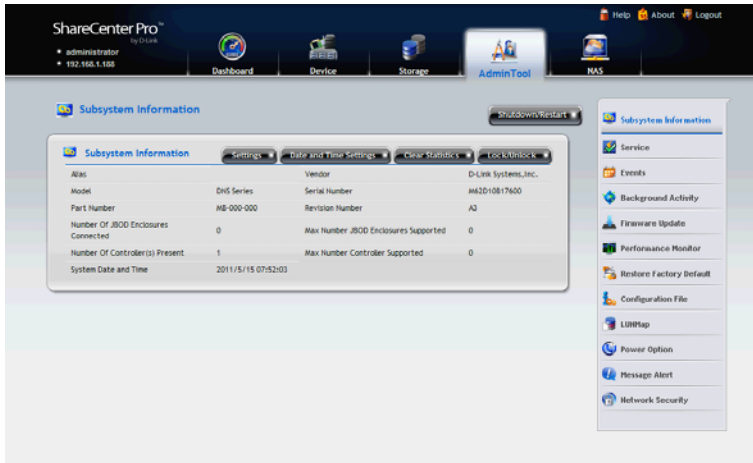

3.5.1 System settings and clearing statistics

The list of NAS system information, including:

- Alias, if assigned
- Vendor
- Model
- Serial Number
- Part Number
- Revision Number
- Number of JBOD Enclosures Connected
- Max Number JBOD Enclosures Supported
- Number of Controller(s) Present
- Max Number Controller Supported
- System Date & Time

To change the Subsystem settings;

1. Click **AdminTool** tab > **Subsystem Information**. The list of system information
2. Click the **Settings** button.
3. In the Alias field, enter an alias or change the existing alias.
4. When done, click the **Save** button.

To restart/shutdown the Subsystem:

1. Click **AdminTool** tab > **Subsystem Information**.
2. Click the **Shutdown/Restart** button.
3. In the Shutdown/Restart window, you can:
 - Click the **Shutdown** button to stop I/Os and shuts down the subsystem. After subsystem shutdown, you must manually switch off the power at both power supplies.
 - Click the **Restart** button to stop I/Os, shuts down and restarts the subsystem.
 - Click the **Power Off** button to turn off the system power. After power off, the power cord(s) has to be removed then plugged in to get Redundant PSU working again.

You can clear the physical drive, logical drive, and controller statistics by following the steps below:

1. Click the **AdminTool** tab > **Subsystem Information**. The list of system information.
2. Click the **Clear Statistics** button.
3. When done, click the **Confirm** button.

3.5.2 Services

To start a service on the ShareCenter® Pro DNS-1550-04:

1. Click the **AdminTool** tab > **Service**. The list of services displays.
2. Move your mouse over the service you want and click the **Start** button.

Name	Status
Telnet	Started
SSH	Started
SNMP	Stopped
PXE Server	Stopped
Web Virtual Host	Started

3. Click the **Confirm** button.

3.5.3 Runtime and NVRAM event logs

Runtime events are the 1023 most recent events since the last NAS startup.

To view runtime events, click the **AdminTool** tab > **Events**.

Index	Device	Event ID	Severity	Time	Description
4	PSU 1 Enc 1	0x000E0009	Warning	May 15, 2011 07:30:47	PSU has been removed
3	Port 1 Ctrl 1	0x0007000E	Info	May 15, 2011 07:29:54	Host interface link is up
2	Port 1 Ctrl 1	0x0007000F	Info	May 15, 2011 07:29:52	Host interface link is down
1	Port 1 Ctrl 1	0x0007000E	Info	May 15, 2011 07:29:46	Host interface link is up
0	Ctrl 1	0x00040005	Info	May 15, 2011 07:29:34	The system is started

Total Count: 5 Current Page: 1/1 Page Capacity: 10

The list of Runtime Events displays the information, including:

- Index – A number assigned to this specific event. Highest number is most recent.
- Device – Identifies the device involved.
- Event ID – Identifies the action that occurred.
- Severity – Displays the Severity Level: Info, Minor, Major, Warning, Critical, or Fatal.
 - Fatal – Non-Recoverable error or failure has occurred.
 - Critical – Action is needed now and the implications of the condition are serious.
 - Major – Action is needed now.
 - Minor – Action is needed but the condition is not a serious

at this time.

- Warning – User can decide whether or not action is required.
- Info – Information only, no action is required.
- Time – Date and time the event occurred.
- Description – Plain language description of the event.

The device also Provides NVRAM event logs. NVRAM events are the most important events over NAS startups.

To view NVRAM events:

1. Click the **AdminTool** tab > **Events**.
2. Click the **NVRAM Events** button. The list of NVRAM Events displays the information, including:
 - Index – A number assigned to this specific event. Highest number is most recent.
 - Device – Identifies the device involved
 - Event ID – Identifies the action that occurred
 - Severity – Displays the Severity Level: Info, Minor, Major, Warning, Critical, or Fatal.
 - Fatal – Non-Recoverable error or failure has occurred.
 - Critical – Action is needed now and the implications of the condition are serious.
 - Major – Action is needed now.
 - Minor – Action is needed but the condition is not a serious at this time.
 - Warning – User can decide whether or not action is required.
 - Info – Information only, no action is required.
 - Time – Date and time the event occurred
 - Description – Plain language description of the event

To view Runtime events:

1. Click the **AdminTool** tab > **Events**.
2. Click the **Runtime Events** button. The list of Runtime Events displays the information, including:

-
- Index – A number assigned to this specific event. Highest number is most recent.
 - Device – Identifies the device involved
 - Event ID – Identifies the action that occurred
 - Severity – Displays the Severity Level: Info, Minor, Major, Warning, Critical, or Fatal.
 - Fatal – Non-Recoverable error or failure has occurred.
 - Critical – Action is needed now and the implications of the condition are serious.
 - Major – Action is needed now.
 - Minor – Action is needed but the condition is not a serious at this time.
 - Warning – User can decide whether or not action is required.
 - Info – Information only, no action is required.
 - Time – Date and time the event occurred
 - Description – Plain language description of the event

To clear the NVRAM/Runtime event log:

1. Click the **AdminTool** tab > **Events**.
2. Click the **NVRAM Events/Runtime Events** button. The list of NVRAM Events/Runtime Events displays the information.
3. Click the **Clear** button.
4. Click the **Confirm** button.

To save the NVRAM/Runtime event log:

1. Click the **AdminTool** tab > **Events**.
2. Click the **NVRAM Events/Runtime Events** button. The list of NVRAM Events/Runtime Events displays the information.
3. Click the **Save** button.
4. Your browser saves a text file containing the NVRAM/Runtime event log to its designated download folder.

3.5.4 Background activity, settings and schedules

Each background activity has its own set of parameters. The most important parameters are: Status and Progress. The Status displays:

- Running – Now in Progress.
- Paused – Waiting for a higher priority activity to finish or waiting for you to click the **Resume** button.

To view current background activity, click **AdminTool** tab > **Background Activity**.

Background Activity	Status	
Media Patrol	Media Patrol is not running.	<input type="button" value="Start"/>
Redundancy Check	Redundancy Check is not running.	<input type="button" value="Start"/>
Rebuild	No dead physical drive available in the subsystem for rebuild.	<input type="button" value="Start"/>
Migration	Disk Array Migration is not running.	<input type="button" value="Start"/>
PDM	PDM is not running.	<input type="button" value="Start"/>
Transition	Transition is not available. Array was not rebuilt or spare drive is not revertible. See Product Manual.	<input type="button" value="Start"/>
Synchronization	Synchronization is not running.	

The list of Background Activities displays information, including:

- **Media Patrol:**
 - Media Patrol is a routine maintenance Procedure that checks the magnetic media on each disk drive. Media Patrol checks all physical drives assigned to disk arrays and spare drives. Media Patrol does not check un-configured drives.
 - Media Patrol checks are enabled by default on all disk arrays and spare drives. You can disable Media Patrol in the disk array and spare drive settings, however that action is not recommended.
 - Unlike Synchronization and Redundancy Check, Media Patrol is concerned with the condition of the media itself, not the data recorded on the media. If Media Patrol encounters a critical error, it triggers PDM if PDM is enabled on the disk array.
 - Media Patrol has three status conditions:

-
- Running – Normal. You can access your logical drives at any time.
 - Yield – Temporary pause while a read/write operation takes place.
 - Paused– Temporary pause while another background runs. Or a pause initiated by the user.
- **Redundancy Check:**
- Redundancy Check is a routine maintenance Procedure for fault-tolerant disk arrays (those with redundancy) that ensures all the data matches exactly. Redundancy Check can also correct inconsistencies.
- **Rebuild:**
- When you rebuild a disk array, you are actually rebuilding the data on one physical drive.
 - When a physical drive in a disk array fails and a spare drive of adequate capacity is available, the disk array begins to rebuild automatically using the spare drive.
 - If there is no spare drive of adequate capacity, but the Auto Rebuild function is ENABLED, the disk array begins to rebuild automatically as soon as you remove the failed physical drive and install an un-configured physical drive in the same slot.
 - If there is no spare drive of adequate capacity and the Auto Rebuild function is DISABLED, you must replace the failed drive with an un-configured physical drive, then perform a Manual Rebuild. See below.

IMPORTANT: IF YOUR REPLACEMENT DISK DRIVE WAS FORMERLY PART OF A DIFFERENT DISK ARRAY OR LOGICAL DRIVE, YOU MUST CLEAR THE CONFIGURATION DATA ON THE REPLACEMENT DRIVE BEFORE YOU USE IT.

– **Migration:**

- The term "Migration" means either or both of the following
 - Change the RAID level of a logical drive
 - Expand the storage capacity of a logical drive
- Before you begin a migration, examine your current disk array to determine whether:
 - The physical drives in your array can support the target RAID level
 - There is sufficient capacity to accommodate the target logical drive size
- If you need to add capacity to the array, be sure there are unassigned physical drives installed in you RAID system before you begin the migration.
- Supported RAID level

Target \ Source	RAID0	RAID1	RAID5	RAID6	RAID10
RAID0	•	•	•	•	•
RAID1	•		•		•
RAID5	•		•	•	•
RAID6				•	
RAID10	•		•	•	•

– **PDM:**

- Predictive Data Migration (PDM) is the migration of data from the suspect disk drive to a spare disk drive, similar to rebuilding a logical drive. But unlike Rebuilding, PDM constantly monitors your disk drives and automatically copies your data to a spare disk drive BEFORE the disk drive fails and your logical drive goes Critical.
- The following actions trigger PDM:
 - A disk drive with unhealthy status (see below)
 - Media Patrol finds a disk critical error
 - You initiate PDM manually

-
- PDM also counts the number of media errors reported by Media Patrol.
 - A disk drive becomes unhealthy when:
 - A SMART error is reported
 - The bad sector remapping table fills to the specified level.
 - You can specify the maximum levels for the reassigned and error blocks in PDM settings. When the table fills to a specified value, PDM triggers a migration of data from the suspect drive (the disk drive with the bad sectors) to a replacement physical drive.
 - During data migration, you will have access to your logical drives but they will respond more slowly to read/write tasks because of the additional operation. The time required for data migration depends on the size of the disk drives.
 - PDM is enabled on all disk arrays by default. You can disable PDM in the disk array settings, however that action is not recommended.
- **Transition:**
- Transition is the Process of replacing a revertible spare drive that is currently part of a disk array with an un-configured physical drive or a non-revertible spare. The revertible spare drive returns to its original status. In order to run the Transition function, the spare drive must be revertible.
 - In addition, you must specify an un-configured physical drive of the same or larger capacity and same media type as the revertible spare drive.
- **Synchronization:**
- Synchronization is automatically applied to logical drives when they are created. Synchronization recalculates the redundancy data to ensure that the working data on the physical drives is Properly in sync.
 - Mouse-over on the logical drive, click the **View** button, and

look under Logical Drive Information beside the line that says Synchronized. A **Yes** means the logical drive was synchronized.

Select the item you want (e.g. Media Patrol, PDM, Rebuild, etc.) from the list and click the **Start** button to run the background activity.

To add a scheduled background activity:

1. Click **AdminTool** tab > **Background Activity**.
2. Click the **Scheduler** button.
3. Click the **Add Schedule** button and complete the required settings:

- Scheduler Name – Select Media Patrol, Battery Recondition, Power On, Redundancy Check, Spare Check, or Power Off. If you select Redundancy Check, the following settings need to be completed:
 - Auto Fix – Attempts to repair the Problem when it finds an error.
 - Pause on Error – The Process stops when it finds a non-repairable error.
 - Select LD – Select at least one logical drive on which Redundancy Check will run.
- Enable This Schedule – Select to enable this function.

- Start Time – Choose a start time.
- Recurrence Pattern – Select a Recurrence Pattern as Daily, Weekly, or Monthly.
- Start From – Select a start date.
- End On – Select an end option.

4. When done, click the **Save** button.

To view scheduled background activity:

1. Click **AdminTool** tab > **Background Activity**.
2. Click the **Scheduler** button. The list of Scheduled Background Activities displays, including:
 - Type – Media Patrol, Redundancy Check, or Spare Check.
 - Recurrence – Daily, weekly, monthly.
 - Start Time – Date and time.
 - Operational Status – Enabled or disabled.

To change a scheduled background activity:

1. Click **AdminTool** tab > **Background Activity**.
2. Click the **Settings** button. In the Background Activity Settings, you can change the following settings for the background activity:

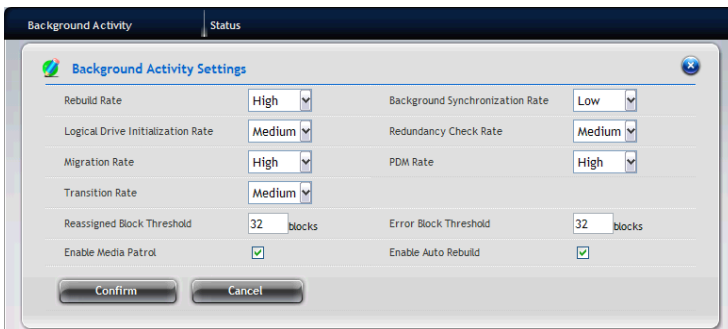

- Rebuild Rate
- Background Synchronization Rate
- Logical Drive Initialization Rate
- Redundancy Check Rate
- Migration Rate
- PDM Rate

- Transition Rate
- Reassigned Block Threshold
- Error Block Threshold
- Enable Media Patrol
- Enable Auto Rebuild

For example, to change the Rebuild settings:

1. Click the Rebuild Rate dropdown menu and choose a rate:
 - Low – Fewer system resources to the Rebuild, more to data read/write operations.
 - Medium – Balances system resources between the Rebuild and data read/write operations.
 - High – More system resources to the Rebuild, fewer to data read/write operations.
2. Check the **Enable Auto Rebuild** box to enable Auto Rebuild (rebuilds when you swap out the failed drive with a new one).
3. Click the **Confirm** button.

3.5.5 Firmware updates

Before you update the firmware, download the latest firmware image file to your PC/Mac

1. Click **AdminTool** tab > **Firmware Update**. The NAS Firmware Update window screen appears showing the current Image Version Number.

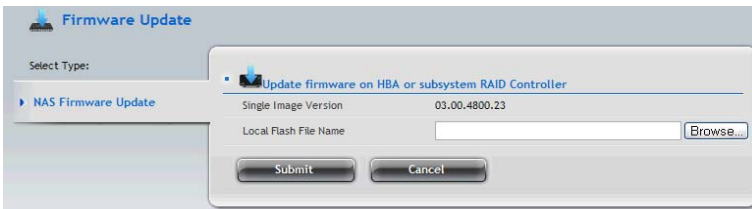

2. Click the **Browse** button to locate the firmware image file, and then click the **Open** button.
3. The firmware image file appears in the in the field.

-
4. Click the **Submit** button.
 5. When the update is completed a message tells you to reboot the subsystem. Click the **OK** button to restart the system.

Warning: Do NOT power off the system during the update!

3.5.6 Performance monitor

The Performance Monitor screen allows you to monitor the performance of NAS using the analyzed illustrations.

Support Table:

	Logical Drive	Physical Drive	Port
Bandwidth	●	●	●
Cache Usage	●		
Dirty Cache	●		
Maximum Latency	●	●	●
Average Latency	●	●	●
Minimum Latency	●	●	●
IO request	●	●	●

To view the Logical Drive performance:

1. Click **AdminTool** tab > **Performance Monitor**.
2. In the Logical Drive field, click the Select Logical Drives button to select the logical drive you want and select a performance type from the dropdown menu. When done, the performance of selected logical drive will be shown in the illustration below.



To view the Physical Drive performance:

1. Click **AdminTool** tab > **Performance Monitor**.
2. In the Physical Drive field, click the Select Physical Drives button to

select the physical drive you want and select a performance type from the dropdown menu. When done, the performance of selected physical drive will be shown in the illustration below.

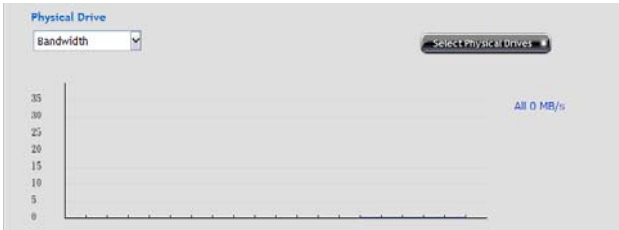

To view the Port performance:

1. Click **AdminTool** tab > **Performance Monitor**.
2. In the Port field, click the **Select Ports** button to select the port you want and select a performance type from the dropdown menu. When done, the performance of selected port will be shown in the illustration below.

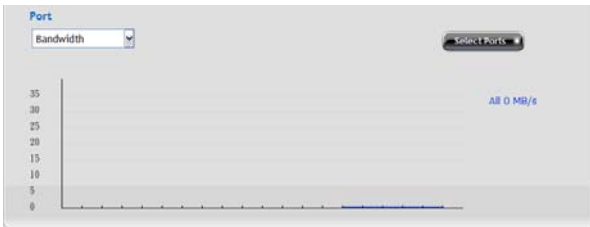

3.5.7 Restore factory default settings

The Restore Factory Default function allows you to restore settings (any or all) to their default values for the NAS.

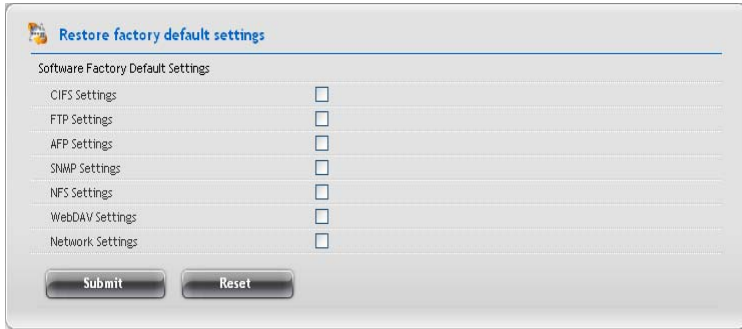

Software Factory Default Settings	
CIFS Settings	<input type="checkbox"/>
FTP Settings	<input type="checkbox"/>
AFP Settings	<input type="checkbox"/>
SNMP Settings	<input type="checkbox"/>
NFS Settings	<input type="checkbox"/>
WebDAV Settings	<input type="checkbox"/>
Network Settings	<input type="checkbox"/>

Submit Reset

The settings include:

- CIFS Settings
- FTP Settings
- AFP Settings
- SNMP Settings
- NFS Settings
- WebDAV Settings
- Network Settings

Caution: Use this feature only when required and only on the settings that you must reset to default in order to set them correctly.

To restore the factory default settings:

1. Click **AdminTool** tab > **Restore Factory Default**.
2. In the Restore factory default settings screen, check the boxes beside the settings you want to reset to default value.
3. Click the **Submit** button.
4. Click the **OK** button in the confirmation box.

3.5.8 Import/Export a system configuration file

To import the configuration file to the NAS:

1. Click **AdminTool** tab > **Configuration File**.
2. Click the **Import** button.

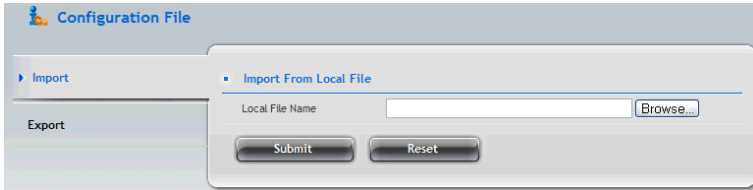

3. Click the **Browse** button to locate the configuration file (.bcf), and then click the **Open** button.
4. Click the submit button
5. The NAS system will reboot

To export the current configuration file:

1. Click **AdminTool** tab > **Configuration File**.
2. Click the **Export** button.

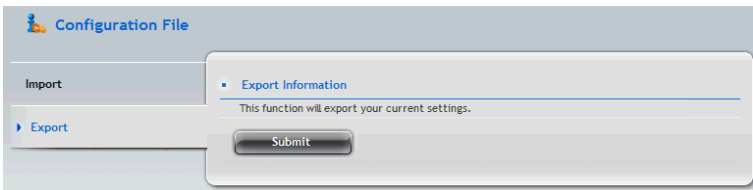

3. Click the **Submit** button. The current configuration will be saved as a .bcf file in your Host PC.

3.5.9 LUNMap Management

The LUN Mapping function allows you to control what storage arrays are visible to which computers.

To add initiator:

1. Click **AdminTool** tab > **LUNMap**.
2. Click the **Add Initiator** button.

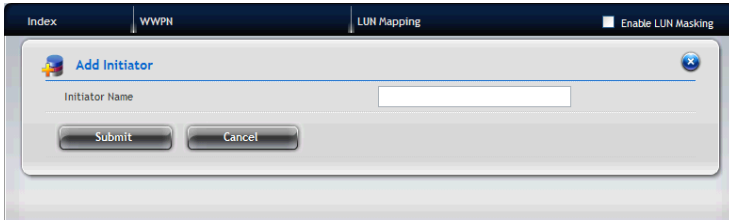

3. Enter a name in the Initiator Name field and click the **Submit** button. The initiator will be added in the LUNMap list.

To define the LUN Mapping

1. Click **AdminTool** tab > **LUNMap**.
2. Click the **LUN Mapping** button.
3. Select the initiator you want from the dropdown menu and click the **Next** button.
4. In the LUN Mapping field, indicate the arrays you wish to make visible by putting a unique number in the LUN field.
5. When done, click the **Assign** button.
6. Click the **Submit** button.
7. Check the **Enable LUN Masking** option to enable the LUN Mapping and Masking function of the NAS.

3.5.10 Power Option

The Power Option screen displays the power management of the NAS.

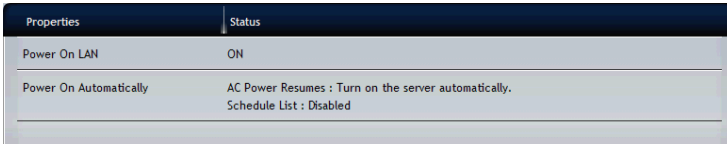

You can change the following power settings from the screen by moving the mouse over the setting item and clicking the **Settings** button:

- Power On LAN
 - When system shutdown, accept magic packet to power ON.
 - ShareCenter® NAVI can be the utility to power on NAS by LAN.
- Power On Automatically

3.5.11 Message Alert

The Message Alert function allows the user to receive an e-mail alert for the events of the NAS.

To set up the e-mail service for the NAS:

1. Click **AdminTool** tab > **Message Alert**.
2. Click the **Setup** button to setup the mail server complete the required settings in the Setup E-Mail Alert field.

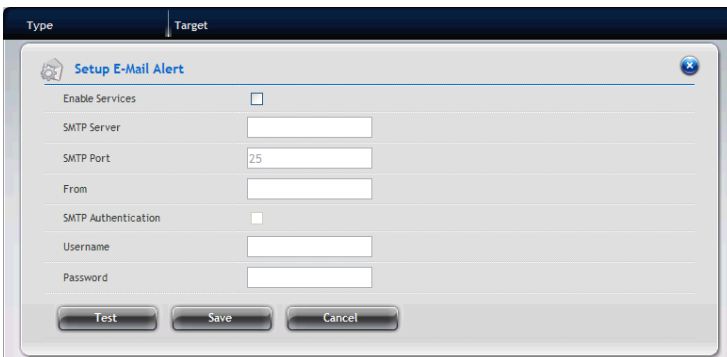

- Enable Services – Check to enable message alert service.
- SMTP Server – Enter the IP address of SMTP server.

- SMTP Port – Enter the port number of SMTP server
- From – The sender of the notification message.
- SMTP Authentication
- Username – Enter the username to log in the SMTP server.
- Password – Enter the password to log in the SMTP server.

To set up the e-mail account:

1. Click **AdminTool** tab > **Message Alert**.
2. Click the **Create** button.
3. Enter your e-mail address and click the **Save** button.

To edit the e-mail account:

1. Click **AdminTool** tab > **Message Alert**.
2. Move your mouse over the e-mail account in the list, and you can:
 - Change the address of the account by clicking the **Settings** button.
 - Remove the selected account by clicking the **Delete** button.

3.5.12 Network Security

To set up Security Policy:

1. Click **AdminTool** tab > **Network Security**.
2. Click the **Security Policy** button and complete the required settings.

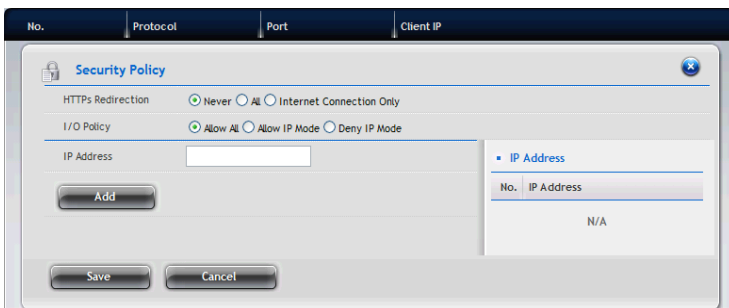

- HTTPs Redirection
 - I/O Policy
 - IP/Domain Name
3. When done, click the **Save** button.

To set up Access Protection:

1. Click **AdminTool** tab > **Network Security**.
2. Click the **Access Protection** button and complete the required settings.

The screenshot shows the 'Access Protection' configuration window. It has a title bar with a lock icon and the text 'Access Protection'. Below the title bar, there are four columns: 'No.', 'Protocol', 'Port', and 'Client IP'. The main area contains the following settings:

- Enable Services:** A checkbox that is currently unchecked.
- Block Policy:** A dropdown menu set to '10 minutes', followed by the text 'after unsuccessful attempts for' and another dropdown menu set to '3 times'.
- Protocol:** A group of checkboxes for 'SSH', 'Telnet', 'FTP', 'AFP', 'Samba', 'WebDAV', and 'HTTP(s)', all of which are currently unchecked.

At the bottom of the window, there are two buttons: 'Save' and 'Cancel'.

- Enable Services – Check to enable the function.
 - Block Policy
 - Protocol
3. When done, click the **Save** button.

To set up SSL Certificate:

1. Click **AdminTool** tab > **Network Security**.
2. Click the **SSL Certificate** button and complete the required settings.

The screenshot shows the 'SSL Certificate' configuration window. It has a title bar with a lock icon and the text 'SSL Certificate'. Below the title bar, there are four columns: 'No.', 'Protocol', 'Port', and 'Client IP'. The main area contains the following settings:

- Specific SSL Certificate:** A checkbox that is checked.
- Certificate (X.509 format):** A large empty text area for pasting the certificate.
- Private Key (X.509 format):** A large empty text area for pasting the private key.

At the bottom of the window, there are two buttons: 'Save' and 'Cancel'.

- Specific SSL Certificate – Check to enable the function.
 - Certificate (X.509 format)
 - Private Key (X.509 format)
3. When done, click the **Save** button.

3.6 NAS Tab

3.6.1 Setup Wizard

The system's Wizard lets you configure your disk array(s) easily and quickly. The Wizard will guide you through the required settings step by step. You can choose to configure automatically by using **One-Click Setup**, or configure manually by using **Advance Setup**.

Using Automatic Configuration Wizard

1. Click **NAS** tab > **Wizard**.
2. Click the One-Click Setup button. The Automatic Configuration box displays:

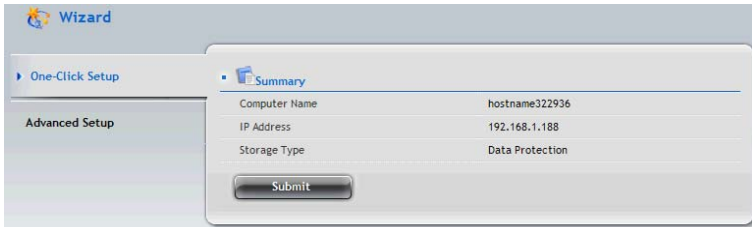

3. The Summary window displays the general information of the system, including:
 - Computer Name
 - IP Address
 - Storage Type
4. To accept the Proposed configuration, click the **Submit** button.

Note: The system will create the RAID automatically based on the number of the disk

Disk number	1	2	3	4	5	6
RAID type	RAID0	RAID1	RAID5	RAID5	RAID5	RAID6

If you disagree with the Proposed configuration, click the **Advance Setup** button to directly specify all parameters for a new disk array, logical drives, and spare drives.

Using Advanced Configuration Wizard

1. Click **NAS** tab > **Wizard**.
2. Click the **Advance Setup** button. The Advanced Configuration box displays:

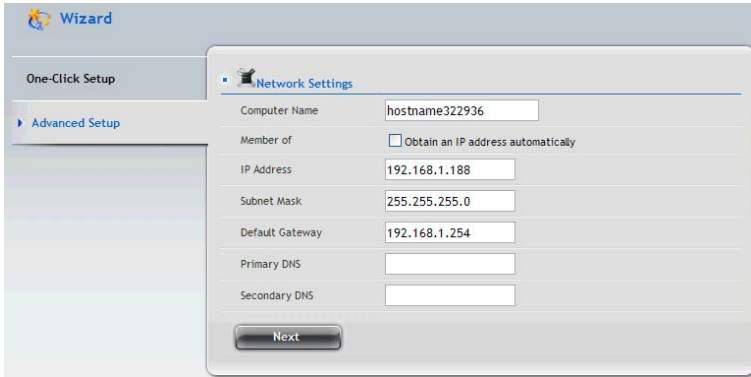

The screenshot shows the 'Wizard' interface with a sidebar on the left containing 'One-Click Setup' and 'Advanced Setup'. The main window is titled 'Network Settings' and contains the following fields:

Computer Name	hostname322936
Member of	<input type="checkbox"/> Obtain an IP address automatically
IP Address	192.168.1.188
Subnet Mask	255.255.255.0
Default Gateway	192.168.1.254
Primary DNS	
Secondary DNS	

At the bottom of the window is a 'Next' button.

3. Complete the required settings in the Network Settings window, including:
 - Computer Name
 - Obtain an IP address automatically
 - IP Address
 - Subnet Mask
 - Default Gateway
 - Primary DNS
 - Secondary DNS

When done, click the **Next** button.

4. Select Storage Type: Data Protection or Maximum Capacity, and then click the **Next** button.
5. The Summary window displays the general information of the system, including:
 - Computer Name
 - IP Address
 - Storage Type

To accept the Proposed configuration, click the **Submit** button.

3.6.2 User account management

To add users for the NAS:

1. Click **NAS** tab > **NAS User**.
2. Click the **Create User** button.
3. In the Create User window, complete the required settings.

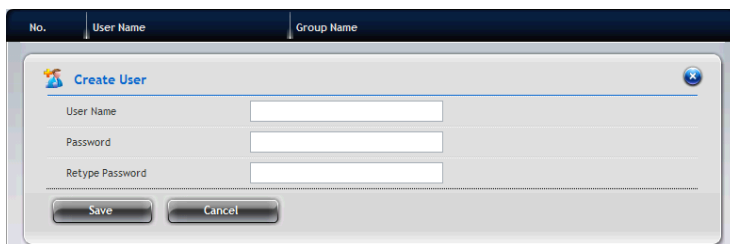

- User Name
 - Password
 - Retype Password
4. When done, click the **Save** button.

To view/edit the user information:

1. Click **NAS** tab > **NAS User**. The list of users displays.
2. Move your mouse over the user in the list, and you can:
 - Change the password for the user to log in the NAS by clicking the **Change Password** button.
 - Remove the selected user by clicking the **Delete** button.

To group the users:

1. Click **NAS** tab > **NAS User**.
2. Click the **Group** button.
3. Click the **Create Group** button to add a group for the system:
 - a. Enter the Group Name, and click the **Next** button.
 - b. Select the user(s) you want to add to the group from the NAS User field.
 - c. When done, click the **Submit** button.

-
4. In the NAS Group list, move your mouse over the group item and then you can:
 - Add/remove the users for the group by clicking the **Group Settings** button.
 - Remove the selected group by clicking the **Delete** button.

When the new user/group is added, you have to complete the permission settings for each user/group to access the system. Follow the steps below to complete the settings:

1. Click **NAS** tab > **File Sharing**.
2. From the File Sharing list, move your mouse over the folder you want and click the **Share Settings** button.
3. Select the user/group you want and set one of the access options: Deny-Access, Read-Only, or Read-Write

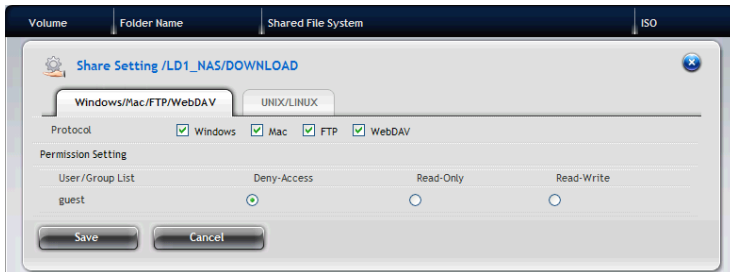

4. When done, click the **Save** button.

3.6.3 Protocol Control and Setting

1. Click **NAS** tab > **Protocol Control**.
2. In the Protocol Control list, move your mouse over the Protocol option you want and click the **Enable/Disable** button to turn the feature ON/OFF. The Protocols include:

Protocol	Status
Windows (CIFS)	ON
FTP Sharing	ON
UNIX/Linux	ON
Mac AFP	ON
Printer Server	ON
WebDAV	ON

- Windows (CIFS)
 - FTP Sharing
 - UNIX/Linux
 - Mac AFP
 - Printer Server
 - WebDAV
3. To change the Protocol settings, move your mouse over the Protocol option and click the **Settings** button to configure the advanced settings.

3.6.4 File System Management

1. Click **NAS** tab > **File System**.
2. In the File System list, move your mouse over the item you want and you can:

Volume	Device ID	RAID Level	Capacity	Operational Status	File System	Mounted	
LD1_NAS	0	RAID5	89.96 GB		Yes	Yes	

- View the volume information by clicking the **View** button.
- Change the quota setting of the file system by clicking the **Quota** button.
- Remove the selected item by clicking the **Delete** button.

3.6.5 File Sharing Setting

Creating ISO Folder

1. Click **NAS** tab > **File Sharing**.
2. Click the **Create ISO Folder** button to add a folder for ISO file sharing:

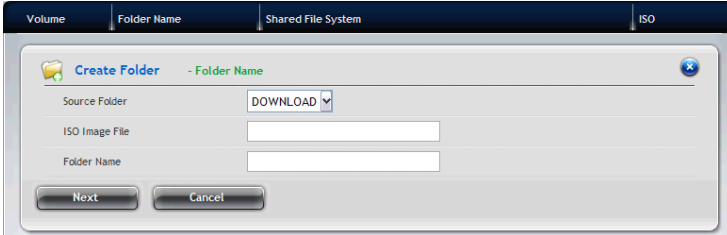

- a. Enter the Source Folder, ISO Image File and Folder Name, and then click the **Next** button.
 - b. Select the Protocol as Windows/FTP or UNIX/LINUX, and then click the **Next** button.
 - c. In the Permission Setting field, set the privilege for the users to access the folder by selecting: Deny-Access, Read-Only, or Read-Write. Click the **Next** button.
 - d. When done, click the **Submit** button.
3. In the File Sharing list, move your mouse over the item and clicking the **Share Setting** button to change the sharing settings.

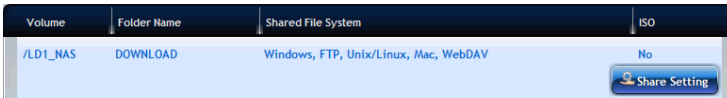

- Windows/Mac/FTP/WebDAV: Select the Protocol for your networking configuration, and set up the Permission Setting for each user/group.
- UNIX/LINUX: Assign the IP address in the New IP Address box then click the **Add** button for sharing. Enter *.*.* if all IP addresses are allowed for sharing.

When done, click the **Save** button.

Creating Folder

1. Click **NAS** tab > **File Sharing**.
2. Click the **Create Folder** button to add a folder for sharing:
 - a. Enter the Volume and Folder Name, and then click the **Next** button.
 - b. Select the Protocol as Windows/FTP or UNIX/LINUX, and then click the **Next** button.
 - c. In the Permission Setting field, set the privilege for the users to access the folder by selecting: Deny-Access, Read-Only, or Read-Write. Click the **Next** button.
 - d. When done, click the **Submit** button.
3. In the File Sharing list, move your mouse over the item and clicking the **Share Setting** button to change the sharing settings.

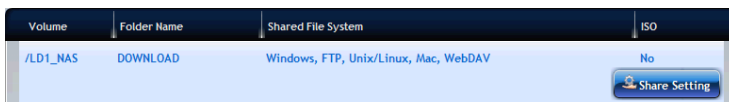

- Windows/Mac/FTP/WebDAV: Select the Protocol for your networking configuration, and set up the Permission Setting for each user/group.

- Windows (CIFS)

Group	Member	Result
Deny-Access	Deny-Access	Deny-Access
	Read-Only	Deny-Access
	Read-Write	Deny-Access
Read-Only	Deny-Access	Deny-Access
	Read-Only	Read-Only
	Read-Write	Read-Write
Read-Write	Deny-Access	Deny-Access
	Read-Only	Read-Write
	Read-Write	Read-Write

- Mac AFP

Group	Member	Result
Deny-Access	Deny-Access	Deny-Access
	Read-Only	Deny-Access
	Read-Write	Deny-Access
Read-Only	Deny-Access	Deny-Access
	Read-Only	Read-Only
	Read-Write	Read-Only
Read-Write	Deny-Access	Deny-Access
	Read-Only	Read-Only
	Read-Write	Read-Write

- FTP

Group	Member	Result
Deny-Access	Deny-Access	Deny-Access
	Read-Only	Deny-Access
	Read-Write	Deny-Access
Read-Only	Deny-Access	Deny-Access
	Read-Only	Read-Only
	Read-Write	Read-Write
Read-Write	Deny-Access	Deny-Access
	Read-Only	Read-Write
	Read-Write	Read-Write

- WebDAV

Group	Member	Result
Deny-Access	Deny-Access	Deny-Access
	Read-Only	Deny-Access
	Read-Write	Deny-Access
Read-Only	Deny-Access	Deny-Access
	Read-Only	Read-Only
	Read-Write	Read-Only
Read-Write	Deny-Access	Deny-Access
	Read-Only	Read-Only
	Read-Write	Read-Write

- UNIX/LINUX: Assign the IP address in the New IP Address box then click the **Add** button for sharing. Enter *.*.* if all IP addresses are allowed for sharing.

When done, click the **Save** button.

3.6.6 Backup

1. Click **NAS** tab > **Backup**.
2. Select the Backup solution you want by clicking the tab: **Snapshot Backup**, **Remote Backup**, **Local Backup**, **Client Backup**, and **Amazon S3**.

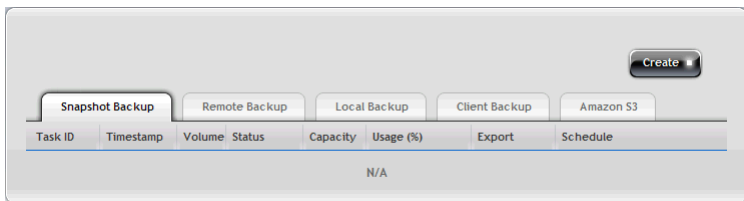

• Snapshot Backup

1. Click **NAS** tab > **Backup** > **Snapshot Backup** tab.
2. Click the **Create** button and complete the required settings in the Create Snapshot window.

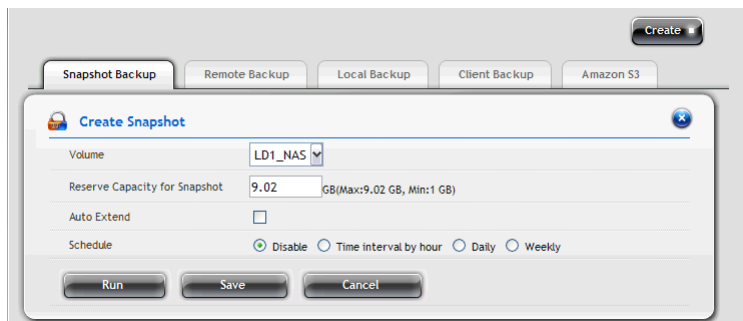

- Volume: Select the desired setting from the dropdown menu.
 - Reserve Capacity for Snapshot: From the dropdown menu, assign the reserved capacity for the backup solution.
 - Auto Extend: Click to checkbox to enable or disable the function.
 - Schedule: Select one of the schedule types you want for the backup solution.
 - Disable – no snapshots will be taken.
 - Time interval by hour – snapshots will be taken at the hourly interval you choose from the dropdown menu.
 - Daily – snapshots will be taken at the time of day you choose from the dropdown menus.
 - Weekly – snapshots will be taken on the day of the week, at the time of day you choose from the dropdown menus.
3. When done, click the **Run** button. The new backup schedule is applied.
 4. To change the settings of the backup solution, move you mouse over the item you want and click the option button.

- Recovery: Click to restore the data volume using the Snapshot.
- Export: Click to export the Snapshot to the share folder.
- Settings: Click to change the settings of the backup solution.
- Delete: Click to delete the backup solution.

● **Remote Backup**

1. Click **NAS tab > Backup > Remote Backup** tab.
2. Click the **Create** button and complete the required settings in the Create Remote Backup window.

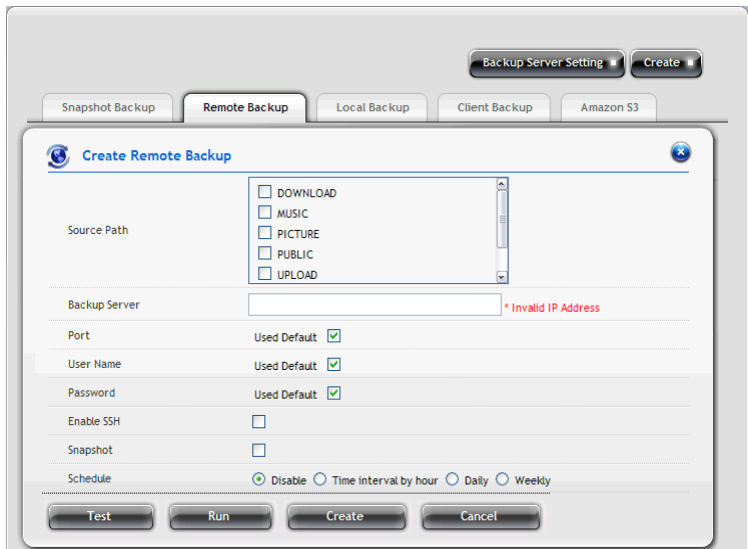

- Source Path
- Backup Server: Enter the IP address of the remote backup server.
- Port: Enter the port number for the remote backup server.
- User Name: Enter the user name to login the remote backup server.
- Password: Enter the password to login the remote backup server.
- Enable SSL: Select this option if the server requires SSL.

-
- Snapshot: Select this option if you want to upload snapshot of backup to the server.
 - Schedule: Select one of the schedule types you want for the backup solution.
 - Disable – no snapshots will be taken.
 - Time interval by hour – snapshots will be taken at the hourly interval you choose from the dropdown menu.
 - Daily – snapshots will be taken at the time of day you choose from the dropdown menus.
 - Weekly – snapshots will be taken on the day of the week, at the time of day you choose from the dropdown menus.
3. When done, click the **Run** button. The new backup schedule is applied.
- You can click the **Test** button to test the server before applying the settings.
4. To change the settings of the backup solution, move you mouse over the item you want and click the option button.

- **Local Backup** enables you to change the backup services of the ShareCenter[®] Pro DNS-1550-04 and the USB storage device. To set the Local Backup settings:

Notes:

- The USB port on the front panel of the device supports Flash drive, which ONLY allows you to backup the data/file from the Flash drive to the ShareCenter[®] Pro DNS-1550-04.
- The four USB ports on the back panel ONLY allow you to backup the data/file from the ShareCenter[®] Pro DNS-1550-04 to the Flash drive.
- Accessible
 - MBR partition (Maximum 2TB)
 - GPT partition
 - File system: FAT(32), NTFS, XFS, EXT3, HFS+
- Format
 - MBR partition (Maximum 2TB)

■ File system: FAT32, NTFS, XFS

1. Click **NAS** tab > **Backup** > **Local Backup** tab.
2. Move your mouse over the USB device you want and click the **Settings** button.

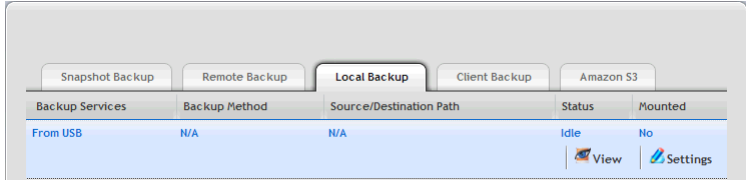

3. Complete the required settings in the Setting window.
 - Select the **Enable Services** checkbox to enable the backup solution.
 - Select a **Backup Method** you want from the dropdown menu: Add Directory, Copy, or Synchronize.
 - Select a **Folder Name** you want from the list.
4. When done, you can:
 - Click the **Save** button to apply the settings.
 - Click the **Run** button to backup immediately.
 - Set the backup schedule by selecting one of the schedule types you want for the backup solution.

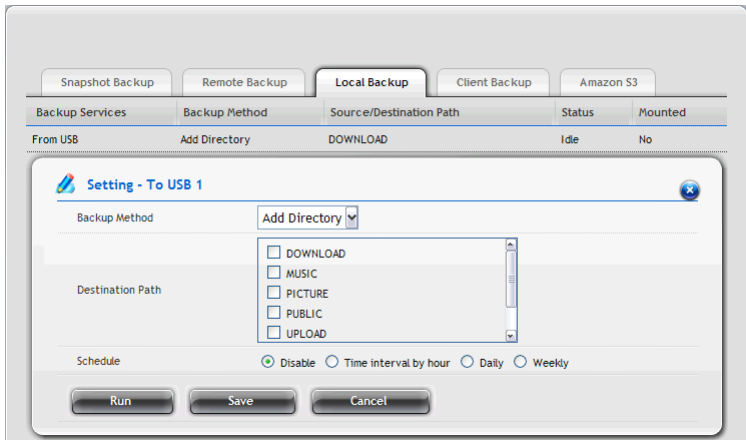

5. To change the settings of the backup solution, move you mouse

over the item you want and click the **Settings** button.

- **Client Backup** allows you to enable One-Touch Backup function.

1. Click **NAS** tab > **Backup** > **Client Backup** tab.
2. Select the **One Touch Backup** checkbox to enable the backup solution.
3. Click the **Save** button.
4. Now you can backup specified folders from your PC to the ShareCenter[®] Pro DNS-1550-04 by simply pressing a button on the front of the ShareCenter[®] Pro DNS-1550-04.

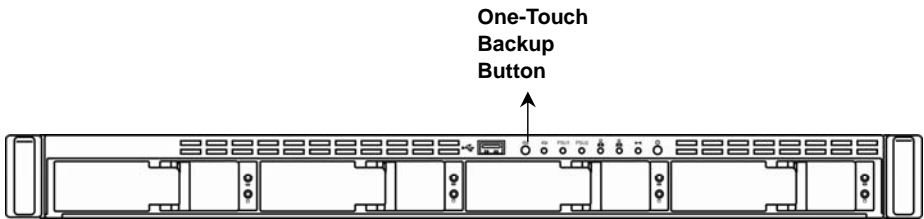

5. To disable One Touch Backup, uncheck **One Touch Backup** and then click the **Save** button.

- **Amazon S3** allows you to upload backup files to Amazon S3 server.
 1. Click **NAS** tab > **Backup** > **Amazon S3** tab.
 2. Click the **Create** button and complete the required settings in the Create Amazon S3 Backup window.

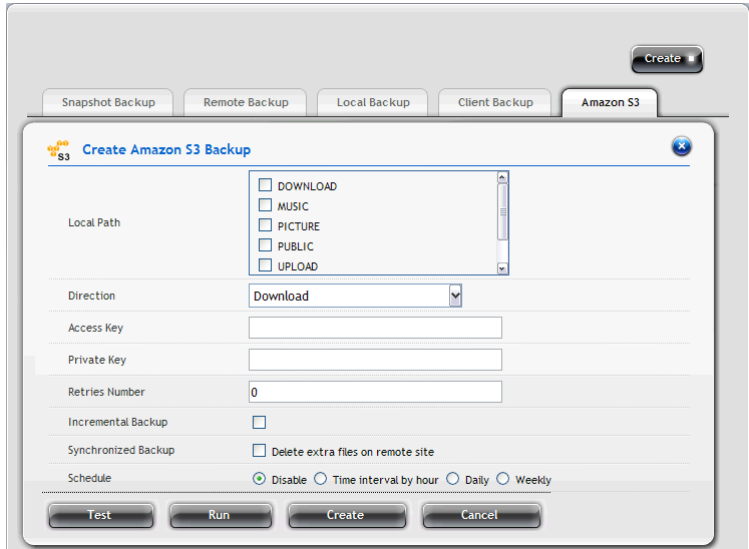

- Local Path
- Direction: Select Download (from Amazon S3 to device) or Upload (from device to Amazon S3).
- Access Key: Enter the Access key for the Amazon S3 server.
- Private key: Enter the Private key for the Amazon S3 server.
- Retries Number
- Increment Backup: Select this option and the backup will add the updated files only.
- Synchronized Backup: Select this option and the backup will delete the extra files while synchronizing.
- Schedule: Select one of the schedule types you want for the backup solution.
 - Disable – no snapshots will be taken.
 - Time interval by hour – snapshots will be taken at the

- hourly interval you choose from the dropdown menu.
- Daily – snapshots will be taken at the time of day you choose from the dropdown menus.
 - Weekly – snapshots will be taken on the day of the week, at the time of day you choose from the dropdown menus.
3. When done, click the **Run** button. The new backup schedule is applied.
You can click the **Test** button to test the server before applying the settings.
 4. To change the settings of the backup solution, move you mouse over the item you want and click the option button.

3.6.7 Plug-in Management

1. Click **NAS** tab > **Plug-in**.
2. Click the **Add** button to add a plug-in for the NAS:
 - a. Click the “**Choose File**” button to locate the plug-in file.
 - b. Click the **Install** button to start installing the plug-in.
3. In the Plug-in list, move your mouse over the item and you can:

No	Name	Status
1	BT Server	Stopped  Open  Start  Re-Install
2	DLNA Server	Started
3	Firefly Media Server	Started
4	MYSQL Server	Stopped
5	OPENLDAP Server	Stopped
6	Web File Manager	Started

- Display the plug-in application in a new window by clicking the **Open** button.
- Stop the plug-in application by clicking the **Stop** button.
- Re-install the plug-in application by clicking the **Re-Install** button.

3.6.8 iSCSI Initiator

1. Click **NAS** tab > **iSCSI Initiator**.
2. Click the **Create** and complete the required settings in the Create Snapshot window.

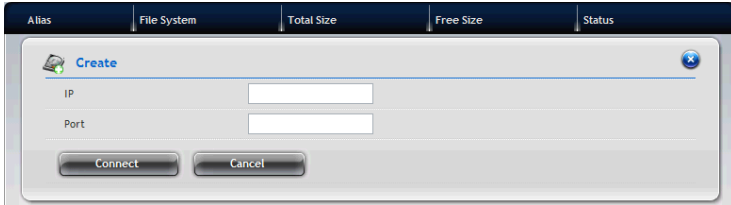

- IP
 - Port
3. When done, click the **Connect** button. After successful logon, you can start to use the disk volume on ShareCenter[®] Pro DNS-1550-04 as a virtual drive on your computer.

Chapter 4: ShareCenter® NAVI

4.1 Working with ShareCenter® NAVI

The ShareCenter® NAVI software connects your PC to the ShareCenter® Pro DNS-1550-04, performs backups, changes the network settings, create RAID volumes, add and mounts folders, and manages file downloads from the Internet.

4.1.1 Opening the Main Window

1. To open the Main Window, do the following actions:
 - If neither Window is open - Double-click the **ShareCenter® NAVI** icon in the Windows application tray or Mac Dock (right).



- If the **ShareCenter® NAVI** Window is open - Double-click a system in the Device List.

2. When the ShareCenter[®] NAVI Window opens, double-click a system in the Device List.

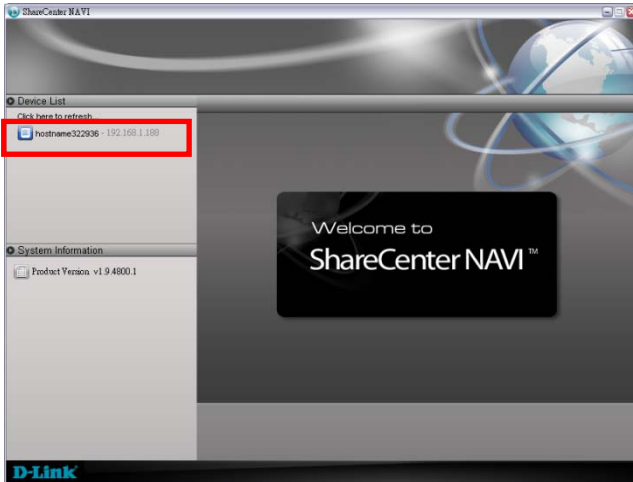

3. When the login window appears, enter the user name and password. Click **Login** then **Yes** to login the system.
The default user name is “administrator” and default password is “password”. The user name and password are case sensitive.



-
4. The Main Window opens, which contains the management features of ShareCenter® NAVI.



4.1.2 Choosing a ShareCenter® NAVI Language

On Windows PCs, ShareCenter® NAVI chooses the display language automatically based on your OS language setting. On Macs, you choose the display language.

To choose a language:

1. Open the **ShareCenter® NAVI Window**.
2. From the dropdown menus, choose **Function > Language**, then choose the the language you prefer.

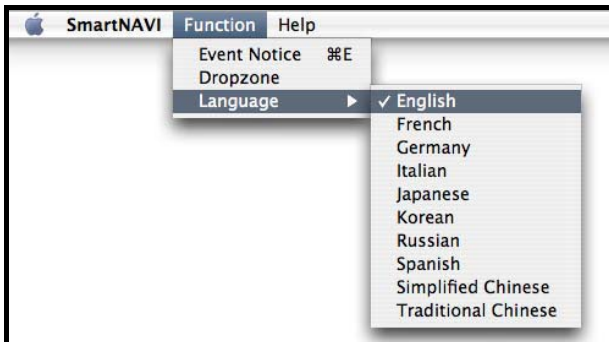

4.1.3 Starting the Advanced Storage Manager

This feature opens Advanced Storage Manager in your default browser.

Main Window

1. Right-click the system in the **Device List** that you want to open in ASM.

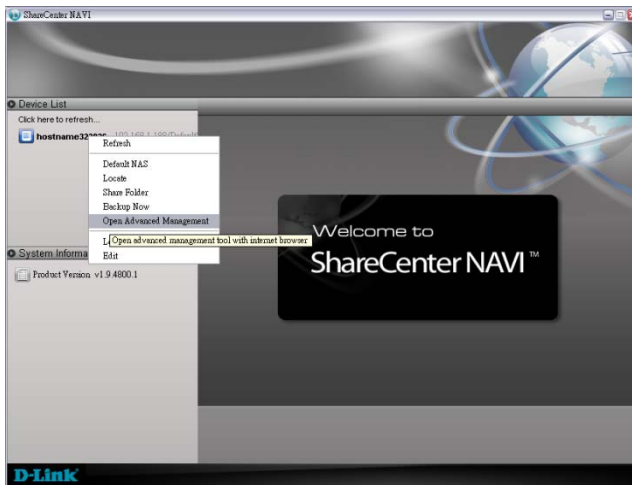

-
2. Choose the **Open Advanced Management** item. The ASM login screen appears in your browser.

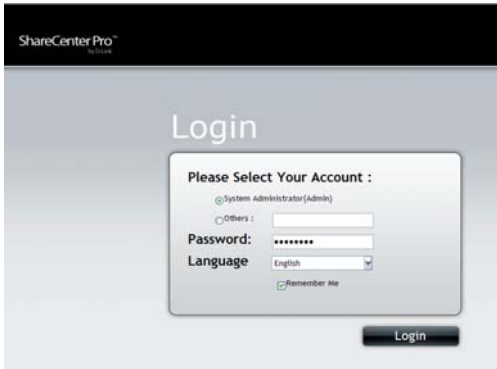

4.1.4 Viewing ShareCenter® NAVI Information

ShareCenter® NAVI is the software application that connects your PC with the ShareCenter® Pro DNS-1550-04 system.

To view information about ShareCenter® NAVI on Windows:

1. Right-click the **ShareCenter® NAVI** icon in the application tray.
2. Choose **About** from the popup menu.

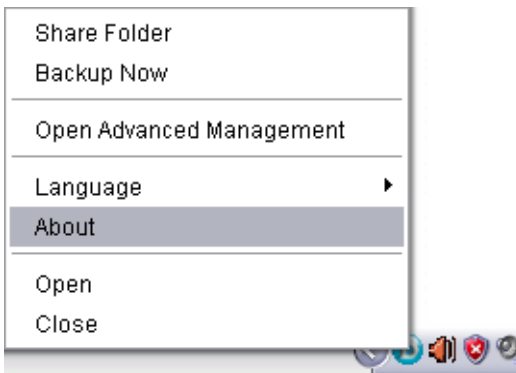

To view information about ShareCenter® NAVI on Mac:

From the dropdown menus at the top of the screen, choose **Help > About**.

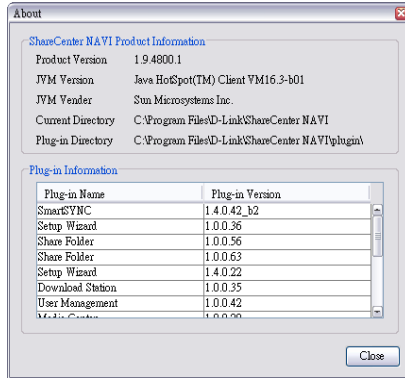

The About window appears and lists the following information:



- ShareCenter® NAVI Version number
- Java Virtual Machine (JVM) Version number
- JVM Vendor name
- ShareCenter® NAVI installation directory on your PC
- ShareCenter® NAVI Plug-in directory on your PC
- Names of installed Plug-ins
- Version numbers of installed Plug-ins

When you are done with the **About** window, click the **Close** button.

4.1.5 Closing ShareCenter® NAVI

To close ShareCenter® NAVI:

Click the close icon on the Main Window.

- Windows  icon in the top right corner
- Mac  icon in the top left corner

For Windows PCs, if you close ShareCenter® NAVI this way, you can open it from the application tray icon.

On Macs, you can always open ShareCenter® NAVI from the Dock icon.

ShareCenter®
NAVI in Windows



ShareCenter® NAVI
in Mac OS X

Alternative Method for Windows

To close ShareCenter® NAVI:

1. Right-click the ShareCenter® NAVI icon in the application tray.
2. Choose Close from the popup menu.

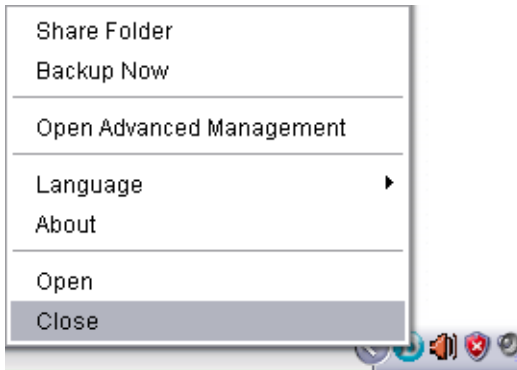

If you close ShareCenter[®] NAVI this way, you must open it from the Start menu.

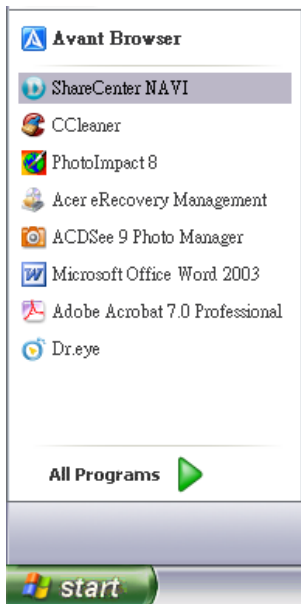

4.2 Managing Backups



Caution

Please do not close the ShareCenter® Pro NAVI or log out of the MS Windows system while you are setting a scheduled back up or running the backup process. It will discontinue the backup process.

4.2.1 Doing a Backup Now

This feature enables you to perform an immediate scheduled backup of your files from your Windows or Mac to the NAS system (ShareCenter® NAVI).

You can perform an immediate backup of your files from:

- ShareCenter® NAVI Main Window
- ShareCenter® NAVI Device List
- ShareCenter® NAVI tray icon (Windows PCs only)
- One Touch Button

Main Window

If you do not have a backup schedule for your PC, start your backup from the ShareCenter® NAVI Main Window.

1. Go to the **Main Window**.
2. Click the **SmartSYNC** icon.
3. Click the **Backup** button.
4. Under Backup your data to, choose:

- The NAS or Local drive (your PC or MAC) from the first dropdown menu.
- The letter designation of your PC or MAC drive under the second dropdown menu.

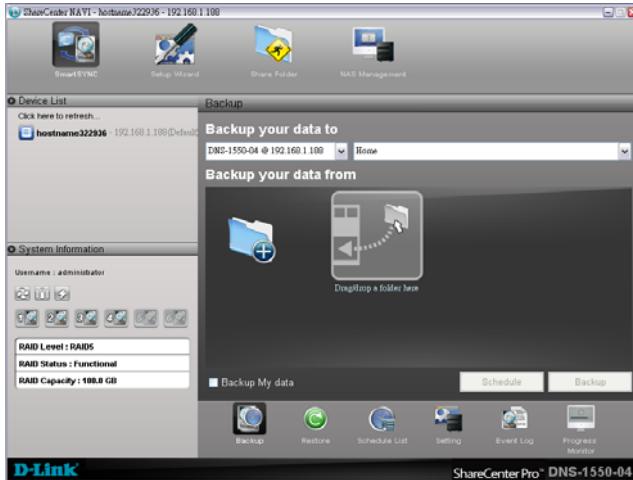

5. Do any of the following actions to select your backup folders:

-
- Check the **Backup My Data** box – Selects the My Documents, Favorites, and Desktop folders with all their contents.

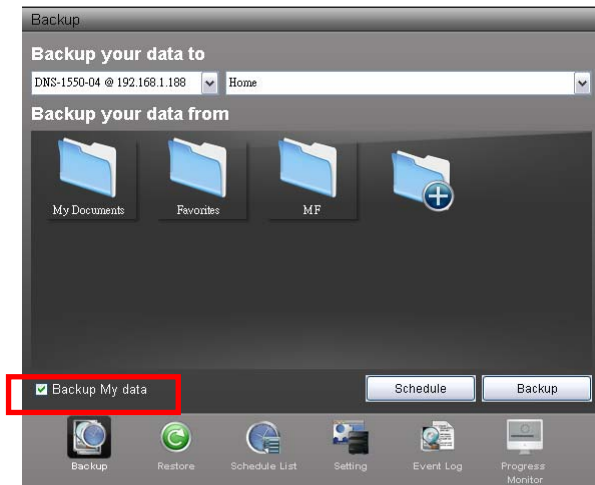

- Click the **Add to Backup**  icon – Opens the My Documents folder. Click a folder you want to backup, and then click the **Choose** button. Repeat for additional folders.

- Drag and drop the folders you want to backup to the **Backup your data from** window.

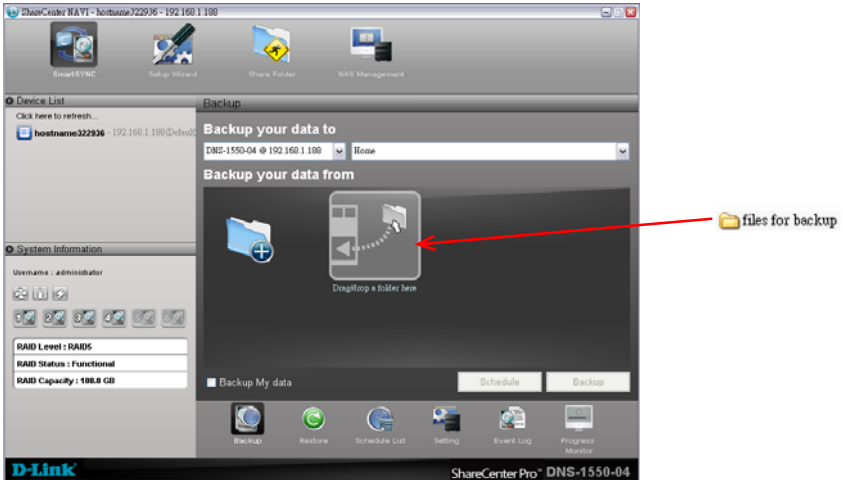

6. Click the **Backup** button.
The backup begins immediately.

Device List

Before you can do a backup from the ShareCenter® NAVI Main Window, you must create a backup schedule.

1. Go to the **Main Window**.
2. Right-click the system in the **Device List** whose backup you want to run.
3. Choose the **Backup Now** item.

The backup begins immediately.

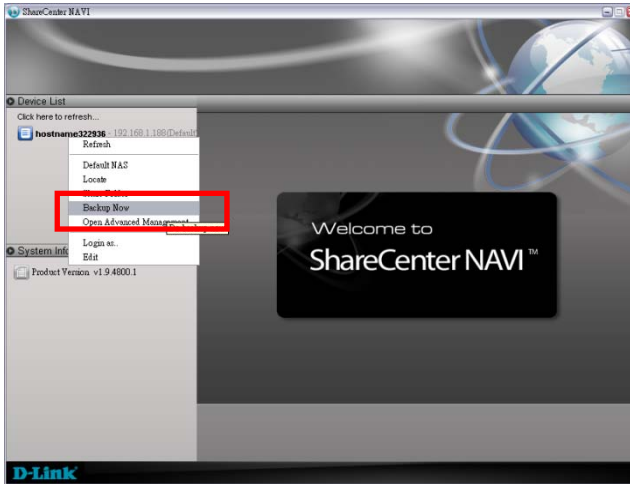

Tray Icon

Before you can do a backup from the ShareCenter® NAVI tray icon, you must create a backup schedule and setup default NAS first. This feature applies to Windows PCs only.

1. Right-click the **ShareCenter® NAVI** icon in the application tray.
2. Choose **Backup Now** in the popup menu.

The backup begins immediately.

The amount of time required depends on the size and number of files being backed up.

The backed up files will appear on the NAS system (ShareCenter® NAVI) in a folder named **BACKUPDATA_ your username**.

You can restore the backup files to your PC at any time.

See “Restoring Backed-up Files” on page 107.

4.2.2 Scheduling a Backup

You can schedule backups by the hour, day, or week.

To set a schedule for backing up files from your PC to the NAS system (ShareCenter® NAVI):

1. Go to the **Main Window**.
2. Click the **SmartSYNC** icon.
3. Click the **Backup** button.
4. Under Backup your data to, choose:
 - The NAS or Local drive (your PC or MAC) from the first dropdown menu.
 - The letter designation of your PC or MAC drive under the second dropdown menu.

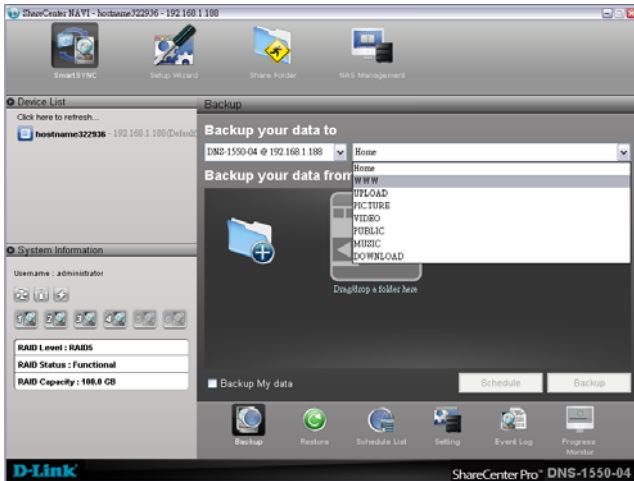

5. Do any of the following actions to select your backup folders:

-
- Check the **Backup My Data** box – Selects the My Documents, Favorites, and Desktop folders with all their contents.

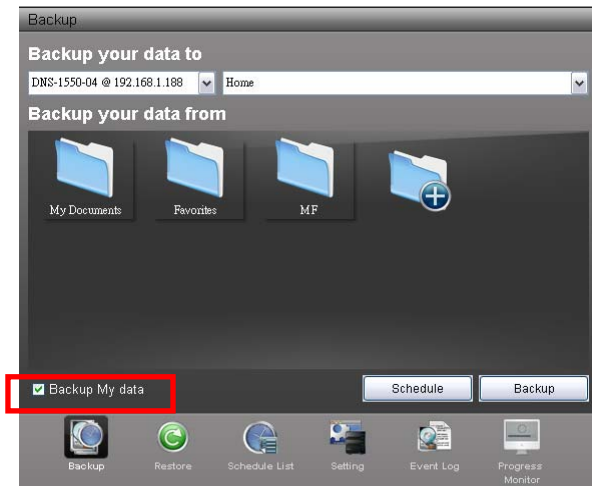

- Click the **Add to Backup**  icon – Opens the My Documents folder. Click a folder you want to backup, and then click the **Choose** button. Repeat for additional folders.

- Drag and drop the folders you want to backup to the **Backup your data from** window.

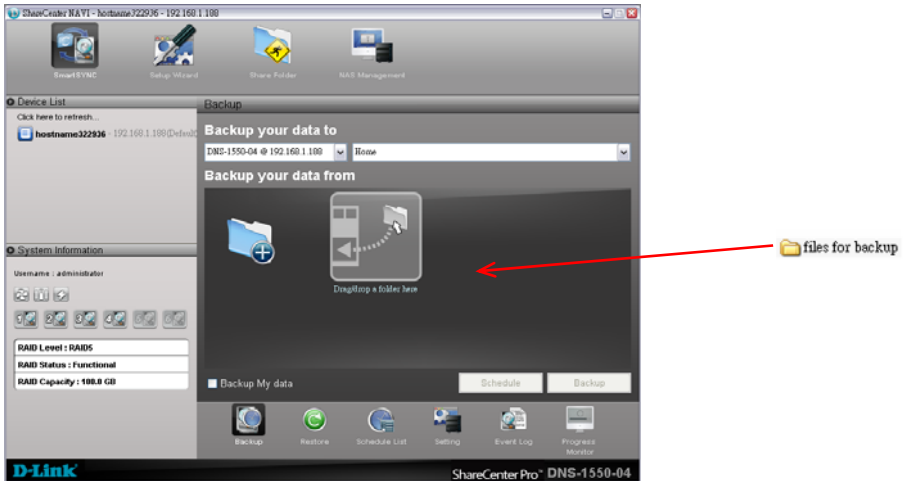

-
6. Click the **Schedule** button.

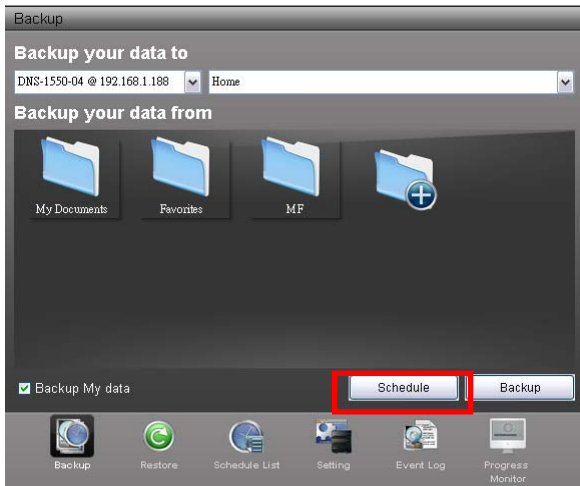

7. Click an option button for:
- Hour
 - Day
 - Day of the week
8. Choose the corresponding values from the dropdown menus:
- Number of hours
 - Time of day in hours and minutes
 - Time of day and day of the week

9. Click the **Add** button.



The newly created schedule appears in the **Schedule List**.

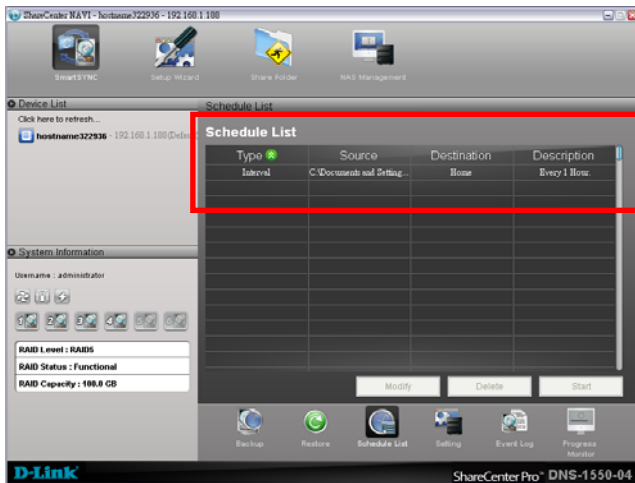

The backed up files will appear on the NAS in a folder named **BACKUPDATA_ your username**.

You can also click the **Start** button to run a scheduled backup immediately.

4.2.3 Viewing Backup Schedules

To view the list of current schedules:

1. Go to the **Main Window**.
2. Click the **SmartSYNC** icon.
3. Click the **Schedule List** button.

The list of all backup schedules appears.

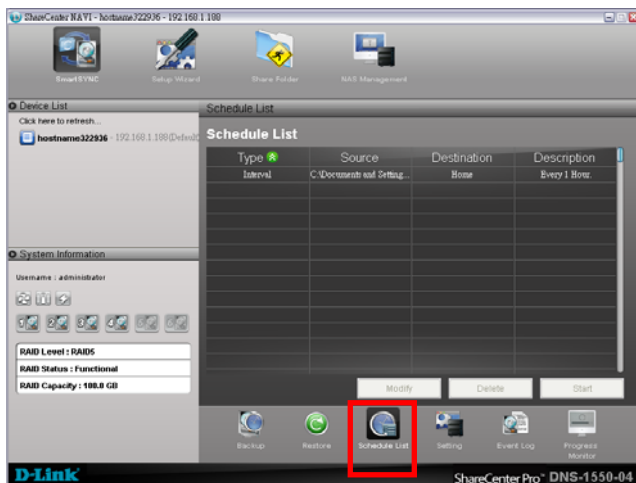

4.2.4 Changing a Scheduled Backup

You can schedule backups by the hour, day, or week.

To change the scheduled backup of files from your PC to the NAS system (ShareCenter® NAVI):

1. Go to the **Main Window**.
2. Click the **SmartSYNC** icon. (A)
3. Click the **Schedule List** button. (B)
4. Click the schedule you want to change. (C)

5. Click the **Modify** button. (D)

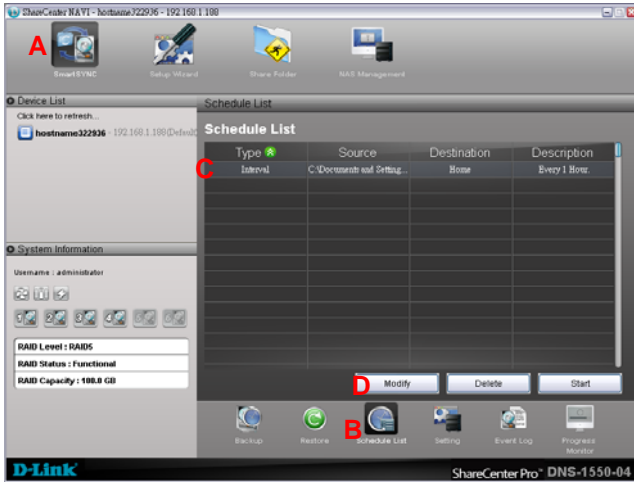

6. Click the folder whose contents you want to backup.



Click the **Add to Backup**  icon to expand the tree and narrow your choices.

7. Click the **Schedule** button.
8. Click an option button for:
 - Hour
 - Day
 - Day of the week
9. Choose the corresponding values from the dropdown menus:
 - Number of hours
 - Time of day in hours and minutes
 - Time of day and day of the week
10. Click the **Add** button.



The modified schedule appears in the **Schedule List**.

You can also click the **Start** button to run a scheduled backup immediately.

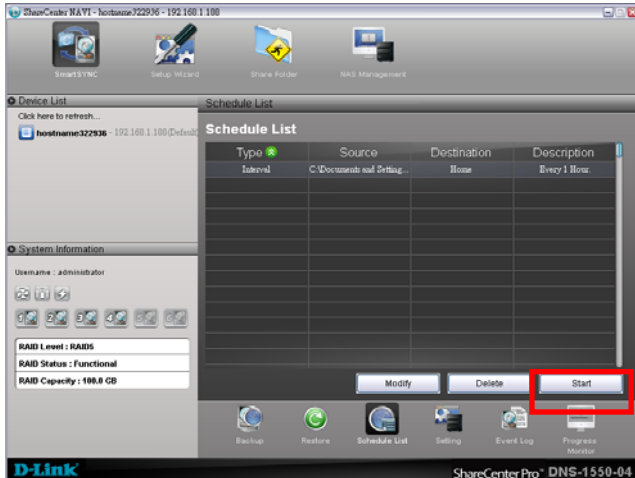

4.2.5 Deleting a Scheduled Backup

Deleting a scheduled backup has no effect upon any files previously backed-up to the NAS system (ShareCenter® NAVI).

To delete a scheduled backup:

1. Go to the **Main Window**.
2. Click the **SmartSYNC** icon. (A)
3. Click the **Schedule List** button. (B)
4. Click the schedule you want to delete. (C)

5. Click the **Delete** button. (D)

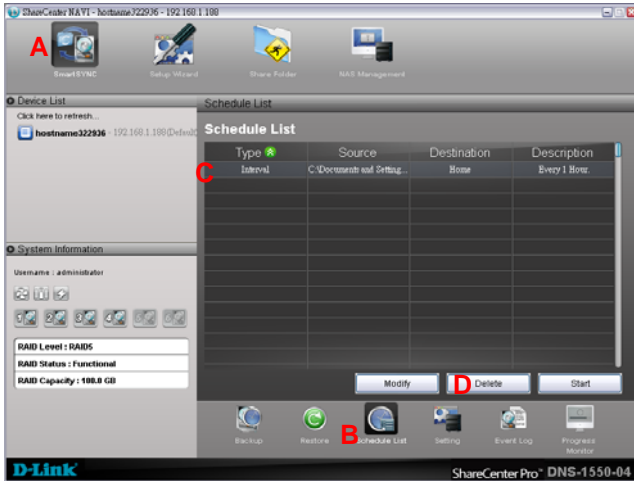

6. Click the **Yes** button in the confirmation box.

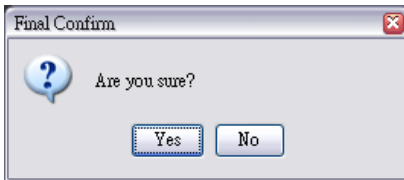

4.2.6 Restoring Backed-up Files

You can restore all or any portion of the files in the **BACKUPDATA_ your username** folder on the NAS system (ShareCenter® NAVI).

You can choose to restore the files to:

- Their original location on your PC or MAC
- An alternative location on your PC or MAC

The original file structure is maintained during backup and restoration.

Caution



If you restore to the original folders on your PC, the restore function will overwrite the files in those folders. Be careful which files you restore and where on your PC you direct the backup files.

To restore your backed-up files from the NAS system to your PC:

1. Go to the **Main Window**.
2. Click the **SmartSYNC** icon. (A)
3. Click the **Restore** button. (B)
4. Click the folder whose contents you want to restore. (C)
Click the arrow icons to expand the tree and narrow your choices. (D)
5. Click an option button for:
 - Restore to original folder - The backup files will overwrite the files on your PC (E)
 - Restore to a specific folder - No files are overwritten on your PC (E)

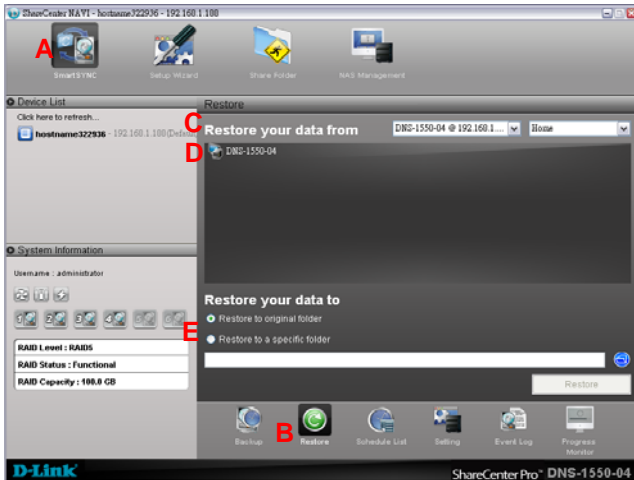

6. If you chose **Restore to a specific folder**, do one of the following actions:

- Type the name of an existing folder in the field Provided
- Type the name of a new folder in the field Provided
- Click the Folder icon - Opens the My Documents folder. (F)

Click a folder you want to use for a target, then click the **Open** button (G)



7. Click the **Restore** button. (H)
8. Click the **Yes** button in the confirmation box.

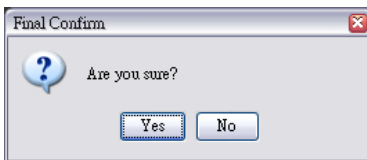

The restoration begins immediately.

The amount of time required depends on the size and number of files being restored.

4.2.7 Viewing the Backup Event Log

Backup events report on backups, schedules, and file transfers.

Events are reported by date, time, severity (information or error) and description.

To view Backup Event Log:

1. Go to the Main Window.
2. Click the SmartSYNC icon. (A)
3. Click the Event Log button. (B)
4. Optional. Set the Event Filter dropdown menu to display: (C)
 - All events
 - Information events only
 - Error events only
5. Optional. Click the arrow on the **Date/Time** header to reverse the chronological order. (D)

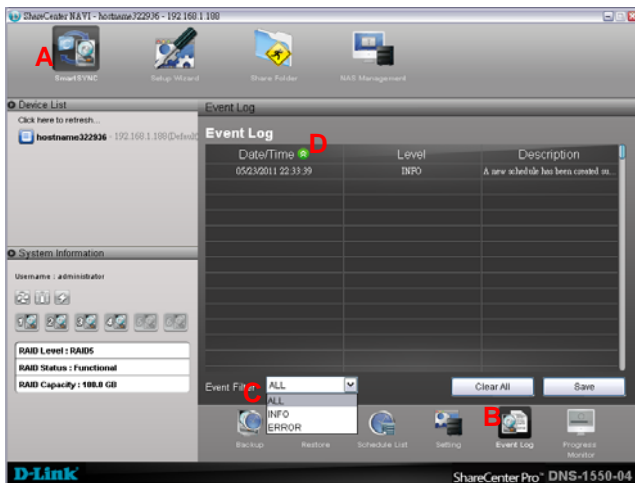



Note

For NAS system events, see “Viewing the System Event Log” on page 129.

4.2.8 Saving the Event Log

This function saves a copy of the Backup Event Log as a text file onto your PC.

The text file records the events displayed in the Event Log window.

Set the Event Filter dropdown menu to display:

- All events
- Information events only
- Error events only

Click the arrow on the **Date/Time** header to reverse the chronological order.

To save a copy of the Backup Event Log as a text file:

1. Go to the **Main Window**.
2. Click the **SmartSYNC** icon.
3. Click the **Event Log** button.
4. Click the **Save** button.

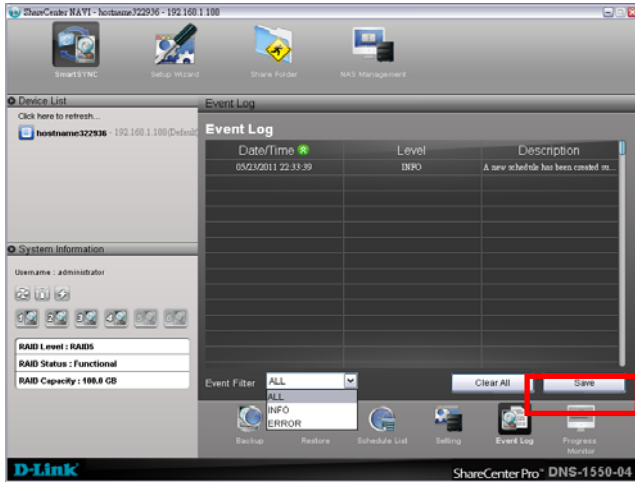

5. Optional. Change the file name or save to a different location.
6. Click the **Save** button in the Save dialog box.

4.2.9 Clearing the Event Log



Note

Before you clear the Backup Event Log, consider saving a copy for future reference. See “Saving the Event Log” on page 111.

To clear the Backup Event Log:

1. Go to the **Main Window**.
2. Click the **SmartSYNC** icon.
3. Click the **Event Log** button.
4. Click the **Clear All** button.

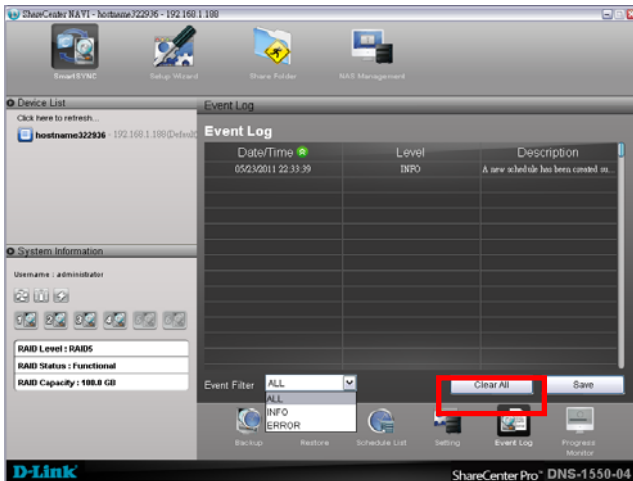

5. Click the **Yes** button in the confirmation box.

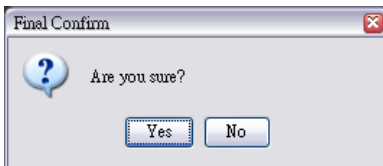

4.2.10 Setting the Port

By using port setting, the public services like a WWW server or an FTP server, and others running on your private network may become accessible from the Internet.

To set the Port:

1. Go to the **Main Window**.
2. Click the **SmartSYNC** icon. (A)
3. Click the **Setting** button. (B)
4. Type the Port number in the field Provided. The default number is 873. (C)
5. Click the **OK** button. (D)

The setting begins immediately.

6. Click the **OK** button in the confirmation box. The Setting is successful.

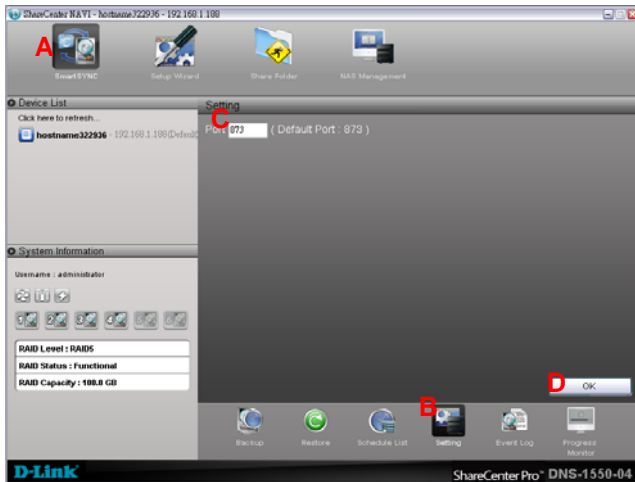

4.3 Managing Share Folders

4.3.1 Opening a Share Folder

This feature opens share folders in the file browser.

From the **Device List**:

1. Right-click the system in the **Device List** whose share folders you want to open.
2. Choose the **Share Folders** item.



All share folders open in your PC's file browser.

From the **Main Window**:

1. Click the **Share Folder** icon.

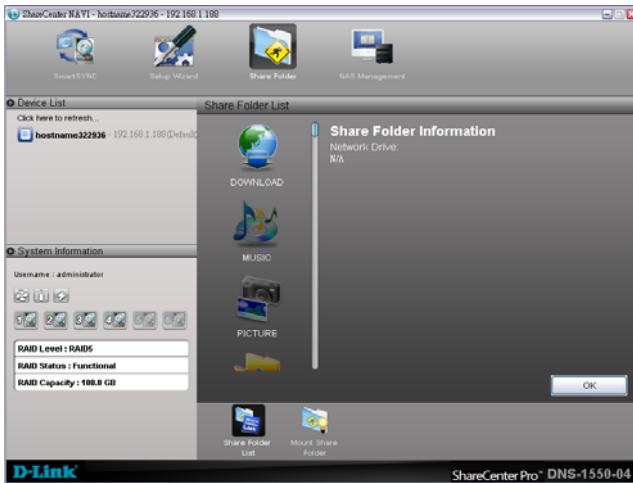

2. Double-click the folder in the **Share Folder List** that you want to open.
The share folder opens in your PC's file browser.

From the Tray Icon:

1. Right-click the **ShareCenter® NAVI** icon in the application tray.
 2. Choose **Share Folder** in the popup menu.
- All share folders open in your PC's file browser.

4.3.2 Viewing a List of Share Folders

To view a list of Share Folders:

1. Go to the **Main Window**.
2. Click the **Share Folder** icon.
3. Click the **Share Folder List** button.

The Share Folder List appears.

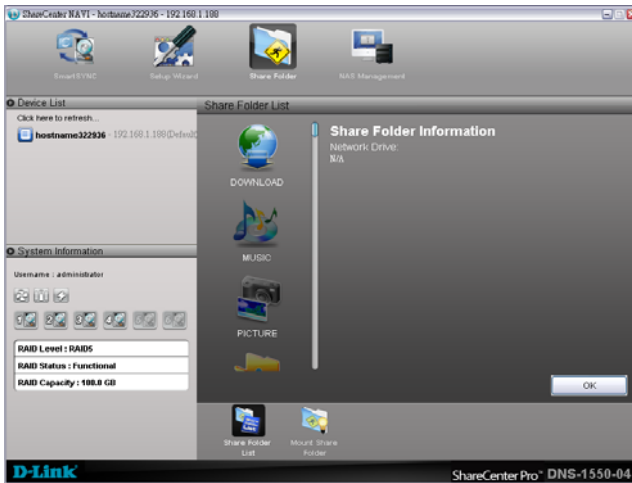

4. Double-click the individual share folder to view its contents.

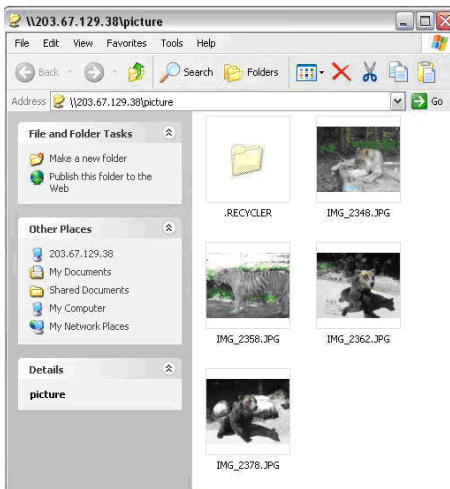

4.3.3 Mounting a Share Folder /Creating a Network Drive

To mount a share folder or create a network drive (Windows):

1. Go to the **Main Window**.
2. Click the **Share Folder** icon. (A)
3. Click the **Mount Share Folder** button. (B)
Click the share folder you want to mount or make a network drive. (C)
4. The folder name will become highlighted.
5. Choose a device name (drive letter) from the dropdown menu. (D)
6. Click the **Mount** button. (E)

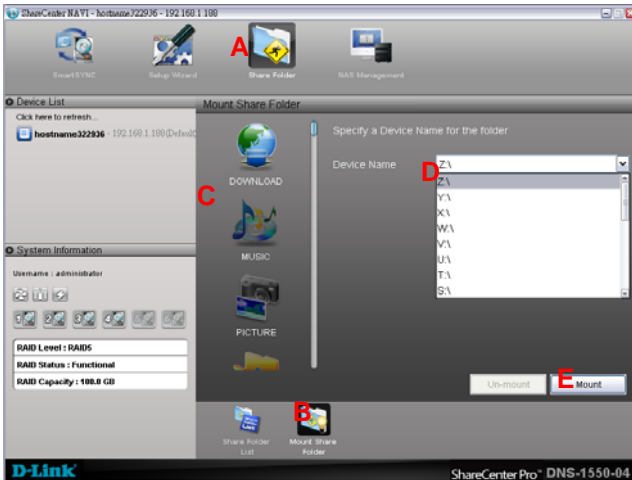

The share folder appears on your PC as a mounted or network drive.

4.3.4 Un-mounting a Share Folder /Disconnecting a Network Drive

To un-mount a share folder or disconnect a network drive (Windows):

1. Go to the **Main Window**.
2. Click the **Share Folder** icon. (A)
3. Click the **Mount Share Folder** button. (B)
4. Click the share folder you want to un-mount or delete as a network drive. (C)
The folder name will become highlighted.
5. Click the **Un-Mount** button. (D)

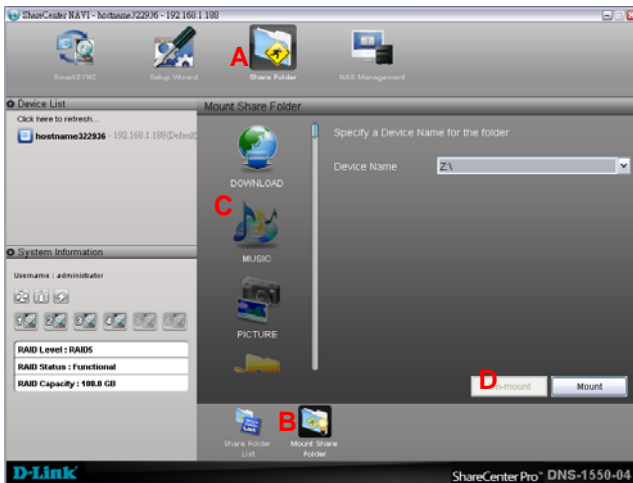

6. Click the **Yes** button in the confirmation box.

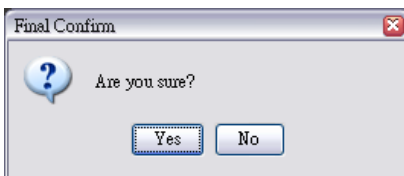

The share folder is un-mounted or disconnected but the link remains (Windows).

4.3.5 Setting up a Share Folder for Time Machine

Time Machine is a backup utility included with Mac OS X 10.5 “Leopard” or more.

Before you begin, be sure your Mac is running and connected to the same network as the ShareCenter® Pro DNS-1550-04.

On ShareCenter® NAVI

To set up a ShareCenter® Pro DNS-1550-04 folder for Time Machine backups:

1. Go to the **Main Window**.
2. Click the **Share Folder** icon.
3. Click the **Mount Share Folder** button.
4. Click the share folder you want to use for Time Machine backups.
5. Check the **Support TimeMachine** box.
6. Click the **Mount** button.

If the Process goes correctly, the following message appears:

This folder has been set to a network drive.

On the Mac

Follow this Procedure if you have not set up Time Machine.

To set up the Mac for backups with ShareCenter® Pro DNS-1550-04:

1. On the desktop, go to the Dock and click the **Time Machine** icon. A popup message informs you that no storage location is set up.
2. In the popup message, click the **Set Up Time Machine** button. The Time Machine dialog box appears.
3. In the Time Machine dialog box, click the **Choose Backup Disk...** button.
4. In the list of external drives, choose the share folder that you mounted on the ShareCenter® Pro DNS-1550-04 and click the **Use for Backup** button. A Name and Password dialog box appears.
5. In the dialog box, enter your username and password of NAS authentication, then click the **Connect** button.

Pre-existing Time Machine Configuration on the Mac

Follow this Procedure if you currently have a Time Machine configuration.

To set up the Mac for backups with ShareCenter[®] Pro DNS-1550-04:

1. On the desktop, go to the Dock and click the **Time Machine** icon. The Time Machine dialog box appears.
2. In the Time Machine dialog box, click the **Change Disk...** button.
3. In the list of external drives, choose the share folder that you mounted on the ShareCenter[®] Pro DNS-1550-04 and click the **Use for Backup** button. A Name and Password dialog box appears.
4. In the dialog box, enter your username and password, then click the **Connect** button.

4.4 Making Management Settings

4.4.1 Configuring a NAS System

The Setup Wizard has two modes:

- **One Click Setup** - Loads a collection of default settings. Recommended for most users.
- **Advanced Setup** - Enables you to make your own settings. Recommended for advanced users.



Caution

Do NOT run the Setup Wizard on a NAS system that is already configured! That action will delete your data and network drives!

One Click Setup

To configure your NAS system using One Click Setup:

1. Go to the **Main Window**.
2. Click the **Setup Wizard** icon.
3. Click the **One Click Setup** button.
4. Click the **OK** button to continue.

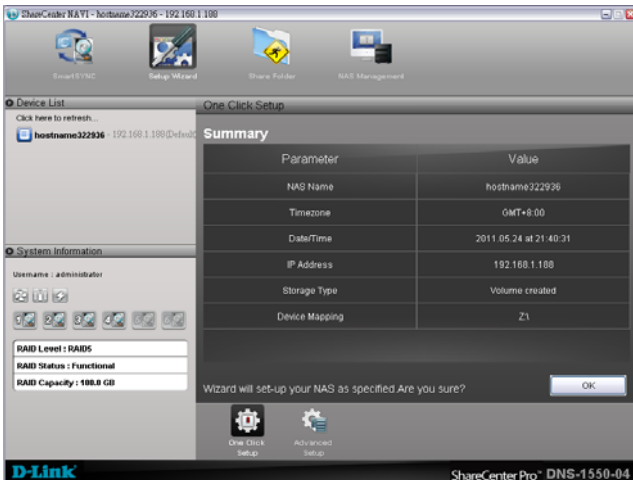

5. Click the **Yes** button in the confirmation box.

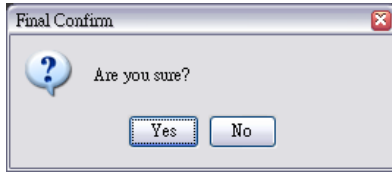

The NAS reboots. Then your RAID volume is ready.

Advanced Setup

To configure your NAS system using Advanced Setup:

1. Go to the **Main Window**.
2. Click the **Setup Wizard** icon. (A)
3. Click the **Advanced Setup** button. (B)
4. Choose **Automatic** (DHCP) or **Manual** network settings. (C)

If you chose **Manual** settings, type entries for each of the following parameters in the fields Provided: (D)

- Computer (NAS system) Name
- IP Address
- Subnet Mask
- Gateway
- Primary and Secondary DNS – optional

Click the **Next** button to continue. (E)



5. Choose the following values from their respective dropdown menus:

- Timezone
- Year
- Month
- Day
- Time in Hours, Minutes, and Seconds

Click the **Next** button to continue.

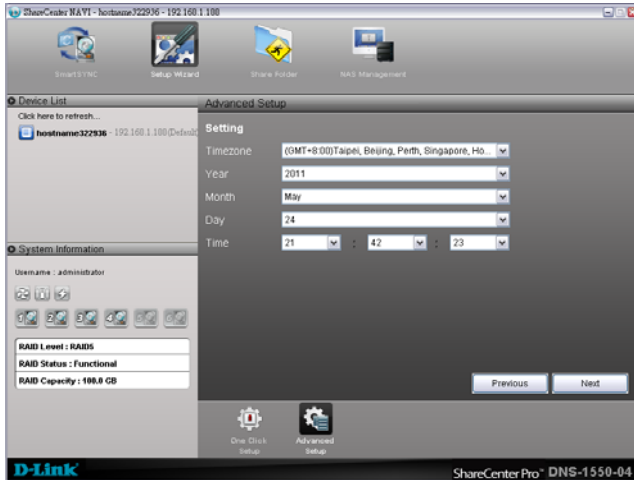

6. Choose Automatic or Manual RAID Volume creation.
If you chose Manual, choose the type of RAID Volume you want:
 - Maximum Capacity and performance - RAID 0, using all disk drives
 - Data Protection - RAID 5, using all disk drivesClick the **Next** button to continue.
7. Choose a network drive letter from the dropdown menu.
This drive will be mapped as a network drive on your PC.
The list begins with S and goes in reverse alphabetical order.
Click the **Next** button to continue.

8. Review your parameters.

To make changes, click the **Previous** button.

To accept the parameters and configure your NAS system, click the **OK** button.

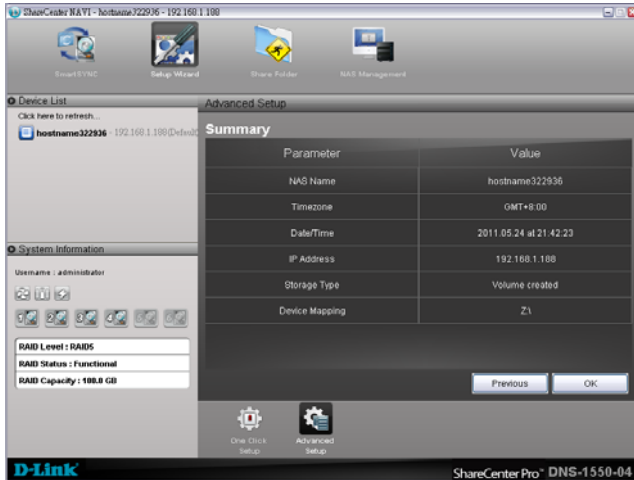

9. Click the **Yes** button in the confirmation box.

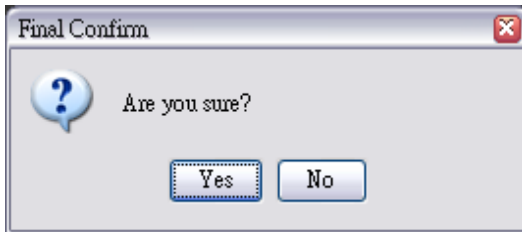

10. The NAS reboots. Then your RAID volume is ready.

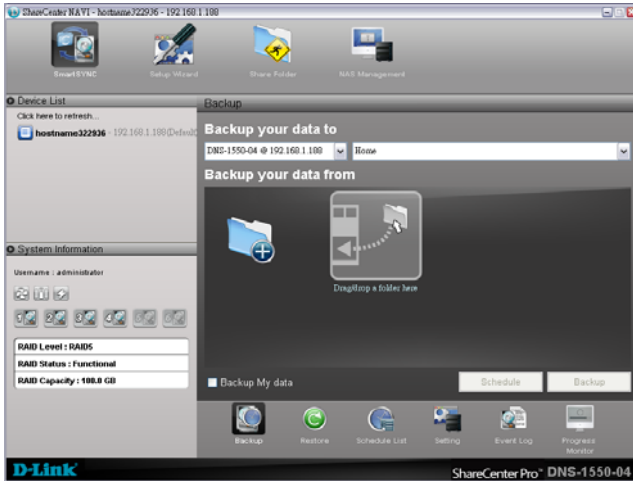

4.4.2 Locating the ShareCenter[®] Pro DNS-1550-04

This feature helps you to physically locate a NAS system.

To locate a ShareCenter[®] Pro DNS-1550-04:

1. Go to the **Main Window**.
2. Right-click the system in the **Device List** that you want to locate.
3. Choose the **Locate NAS** item.

On the NAS system you chose:

- The buzzer sounds three times
- The Status LED blinks RED three times

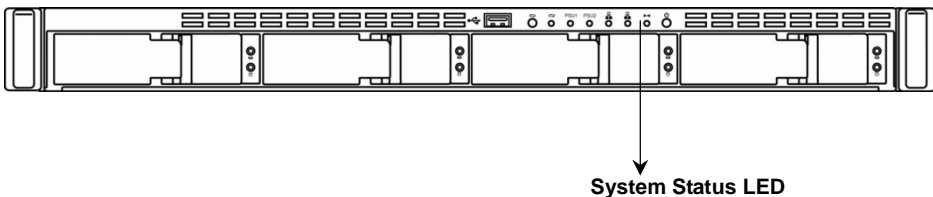

4.4.3 Wake-on-LAN

This feature allows you to turn on or wake up the ShareCenter® Pro DNS-1550-04 by means of the Locate NAS feature.

To wake up a ShareCenter® Pro DNS-1550-04:

1. Go to the **Main Window**.
2. Right-click the system in the **Device List** that you want to wake up.
3. Choose the **Locate NAS** item.

It takes about a minute to boot the ShareCenter® Pro DNS-1550-04.

When fully booted:

- The System Status LED turns blue.
- The buzzer beeps one time.

4.4.4 Choosing a Default NAS System

This feature sets the default NAS system (ShareCenter® Pro DNS-1550-04) for the Main Window and ShareCenter® NAVI tray icon. The default NAS feature activates several important functions, including:

- Share Folder: Opening a Share Folder
- Backup Now: Performing an Immediate Backup
- Open Advanced Management: Starting the Advanced Storage Manager
- Event Notice: Enabling Event Notification

If you do not choose a default NAS, ShareCenter® NAVI sets the default NAS after you first log on.

To set a default NAS:

1. Go to the **Main Window**.
2. Right-click the system in the **Device List** that you want to make the default.
3. Choose the **Default NAS** item.

The default NAS is highlighted in the Device List.



4.4.5 Viewing the System Event Log

NAS events report functions and status of the NAS system. The Event Log displays the 20 most recent events.

Events are reported by date, time, severity (information or warning) and description.

To view the NAS system is Event Log:

1. Go to the **Main Window**.
2. Click the **Smart SYNC** icon.
3. Click the **Event Log** button.

Click the arrow on the **Date/Time** header to reverse the chronological order.

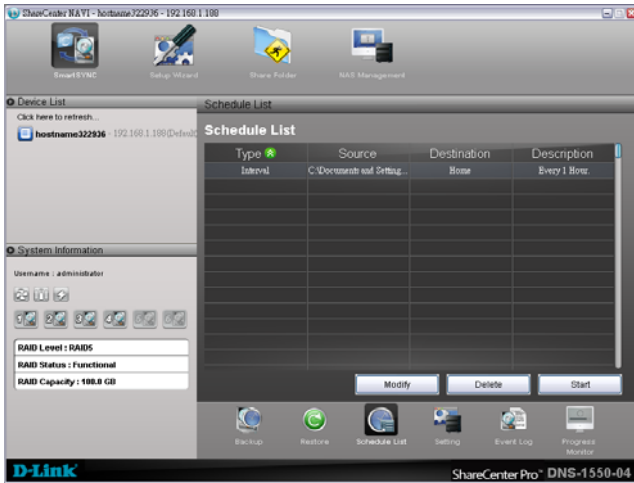

Note

For backup system events, see “Viewing the Backup Event Log” on page 110.



Warning

Do not disconnect the power or shut down the ShareCenter® Pro DNS-1550-04 while the plug-in installation is running!

4. Click the **Configure Plugin** button.
The newly added plug-in appears in the list. Its Service Status is OFF.
5. Click the plug-in to choose it.
The plug-in’s name will become highlighted.

6. Click the **Enable** button.

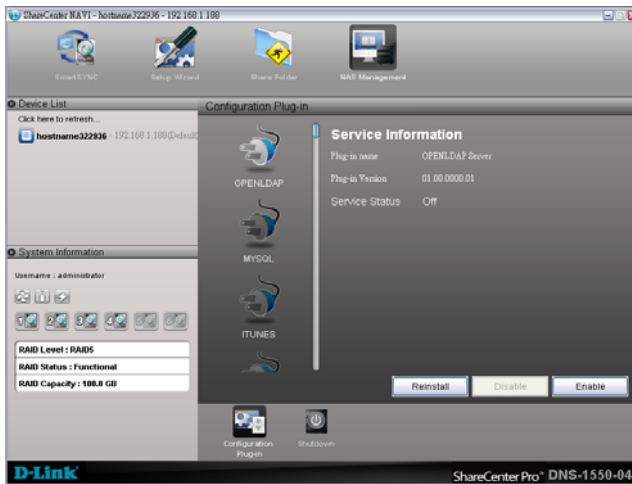

After a moment, the Service Status changes to ON.

The plug-in is now installed ShareCenter® Pro DNS-1550-04.

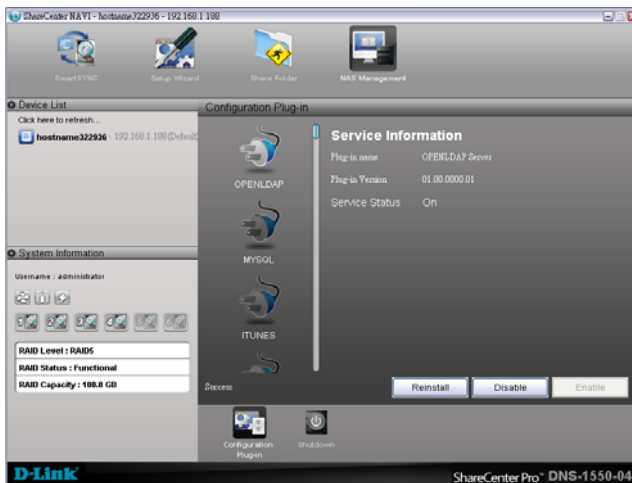

4.4.6 Viewing a List of Plug-ins

To view a list of installed plug-ins:

1. Go to the **Main Window**.
2. Click the **NAS Management** icon.
3. Click the **Configuration Plug-in** button.

Currently installed plug-ins appear in the **Configuration Plug-in** list.

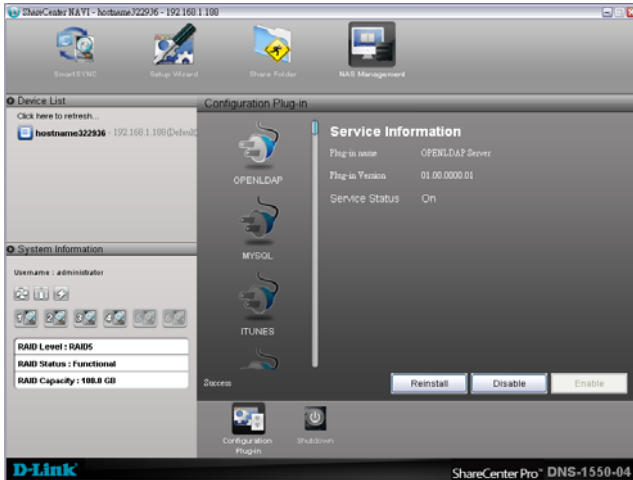

4.4.7 Viewing Plug-in Version Numbers

To view plug-in version numbers:

1. Right-click the **ShareCenter® NAVI** icon in the application tray.

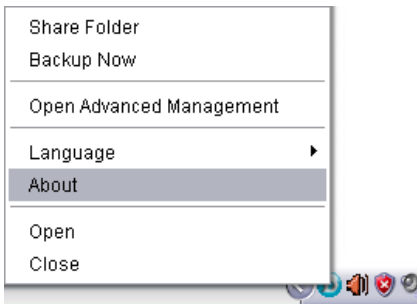

-
2. Choose **About** from the popup menu.

The About window appears. The About window includes a list of installed plug-ins and their version numbers.

When you are done with the About window, click the **Close** button.

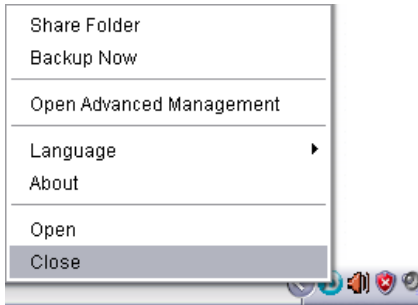

4.4.8 Enabling and Disabling Plug-ins

Enabling Plug-ins

You must add a plug-in to the ShareCenter[®] Pro DNS-1550-04 before you can use this function.

To enable a plug-in:

1. Go to the **Main Window**.
2. Click the **NAS Management** icon. (A)
3. Click the **Configuration Plug-in** button. (B)
4. Click the Plug-in you want to enable. (C)

The plug-in's name will become highlighted.

5. Click the **Enable** button. (D)

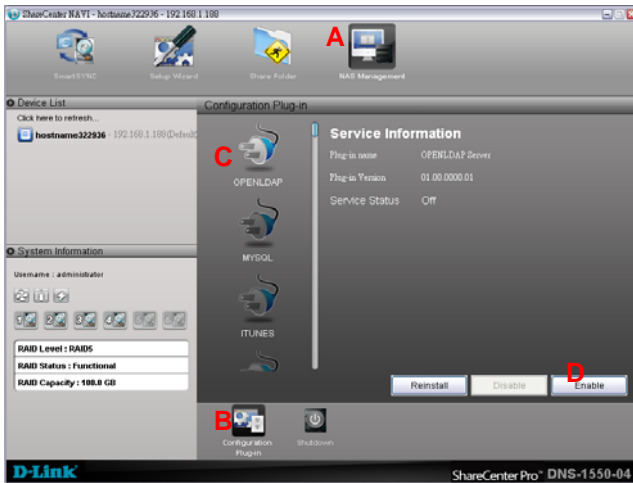

After a moment, the Service Status changes to ON.

The plug-in is now enabled on ShareCenter® Pro DNS-1550-04.

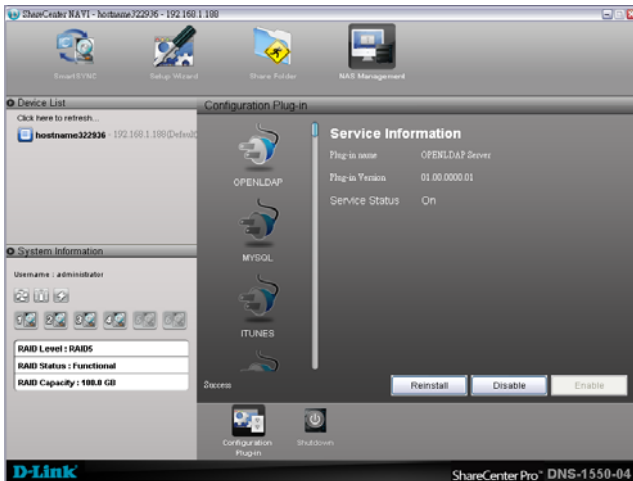

Disabling Plug-ins

Disabling a plug-in saves memory space and Processing time on the ShareCenter Pro DNS-1550-04. If you do not use a feature, consider disabling its plug-in.

To disable a plug-in:

1. Go to the **Main Window**.
2. Click the **NAS Management** icon (A).
3. Click the **Configuration Plug-in** button (B).
4. Click the Plug-in you want to disable (C).
The plug-ins name will become highlighted.
5. Click the **Disable** button (D).

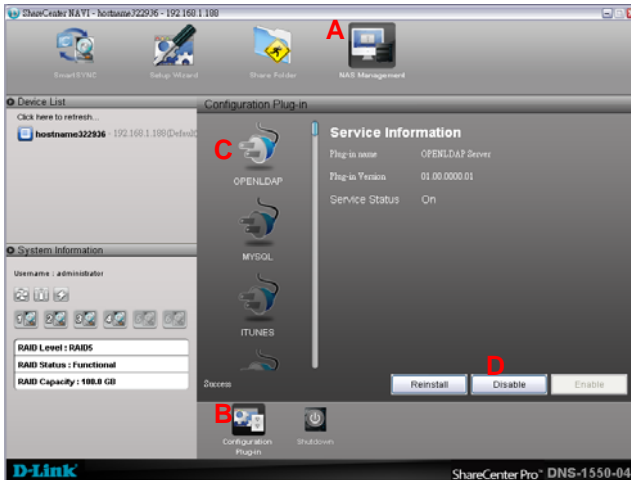

After a moment, the Service Status changes to OFF.
The plug-in is now disabled.

4.4.9 Removing Plug-ins

There are two reasons to remove a plug-in:

- To replace the old plug-in with a new one
- You know that you will never use the plug-in

To remove a plug-in:

1. Go to the **Main Window**.
2. Click the **NAS Management** icon. (A)
3. Click the **Configuration Plugin** button. (B)
4. Click the Plug-in you want to remove. (C)
The plug-ins name will become highlighted.
5. Click the **Remove** button. (D)

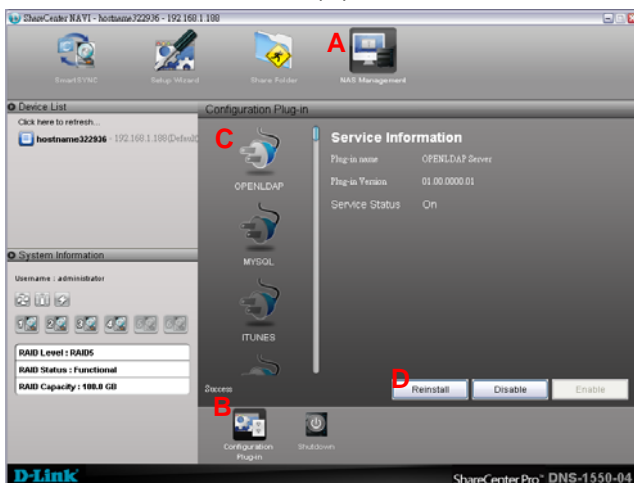

6. Click the **Yes** button in the confirmation box.

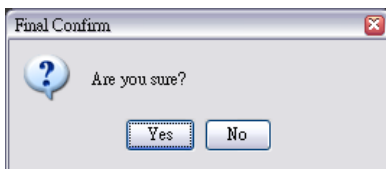

The plug-in is removed from ShareCenter[®] NAVI.

4.4.10 Rebooting the ShareCenter® Pro DNS-1550-04

Normally you will only need to reboot the ShareCenter® Pro DNS-1550-04 is after a firmware upgrade or a plug-in installation. During the reboot, none of your folders will be accessible from your networked PCs.

To reboot the ShareCenter® Pro DNS-1550-04:

1. Go to the **Main Window**.
2. Click the **NAS Management** icon. (A)
3. Click the **Shutdown** button. (B)
4. Click the **Restart** option (C)
5. Click the **OK** button. (D)



6. The reboot runs automatically.



When the ShareCenter® Pro DNS-1550-04 is fully booted:

- The system status LED turns blue
- The buzzer beeps one time (if the buzzer is enabled)

4.4.11 Shutting Down the ShareCenter® Pro DNS-1550-04

The only time you need to shut down the ShareCenter® Pro DNS-1550-04 is to replace the disk drive cooling fan or the power supply.

During and after the shutdown, none of your folders will be accessible from your networked PCs.

Using ShareCenter® NAVI

To shut down the ShareCenter® Pro DNS-1550-04:

1. Go to the **Main Window**.
2. Click the **NAS Management** icon. (A)
3. Click the **Shutdown** button. (B)
4. Click the **Shutdown** option. (C)
5. Click the **OK** button. (D)

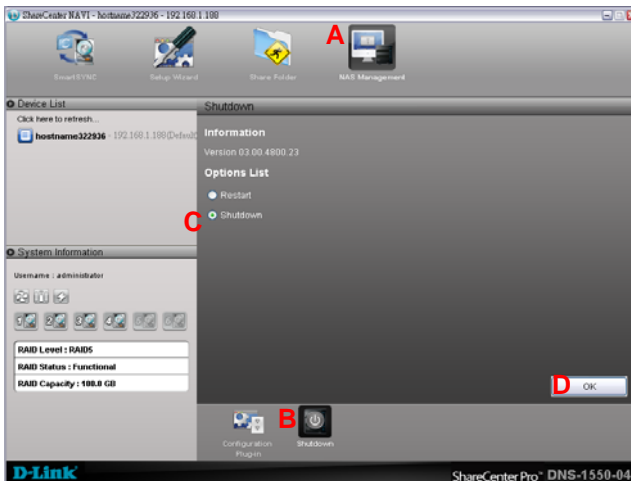

6. The shutdown runs automatically.



Chapter 5: Troubleshooting

5.1 WebPAM PROe system event log

Controller	Corrective Action
The controller parameter(s) changed by user	The user successfully changed controller settings.
The controller has new crash information	Check the event logs.
Controller temperature is above the warning threshold	The controller is overheating. Check for airflow around and through the controller, and verify that all fans are working. Replace fans as needed.
Controller temperature is above the critical threshold	The controller is seriously overheating. Check for airflow around and through the controller, and verify that all fans are working. Replace fans as needed.
Controller temperature is within the warning threshold	Normal.

Disk Array	Corrective Action
New disk array has been created	Result of settings or user action. Normal.
Disk array has been deleted	Result of settings or user action. Normal.
Disk array has been added	Result of settings or user action. Normal.
Disk array has been removed	The physical drives of the disk array were removed from the enclosure.
Disk array settings have been changed	The user successfully disk array settings.

Enclosure	Corrective Action
Enclosure temperature is above the warning threshold	The chassis is overheating. Check for airflow around and through the chassis, and verify that all fans are working. Replace fans as needed.
Enclosure temperature is above the critical threshold	The chassis is seriously overheating. Check for airflow around and through the chassis, and verify that all fans are working. Replace fans as needed.
Enclosure temperature is within the normal range	Normal.

Event Log	Corrective Action
Event log buffer is cleared in RAM	The event log was cleared.
Event log buffer is cleared in NVRAM	The non-volatile RAM event log was cleared.

Front End Driver	Corrective Action
Host interface link is up	Normal.
Host interface link is down	Check network cable/switch.
Host interface controller settings have changed	Result of settings or user action. Normal.

Host Interface Controller	Corrective Action
Host-interface controller has detected bus reset	The initiator sent a reset command. If this message appears repeatedly, contact Technical Support.
Host-interface controller has encountered an unrecoverable error	Restart the NAS.
Host-interface controller has received an abort task/abort task set/clear task set command.	Result of user action. Normal.
Host-interface controller has received a clear ACA command.	Result of clearing an auto contingent alliance condition. If this message appears repeatedly, contact Technical Support.
Host-interface controller has received a LUN reset command.	Result of user action. Normal.
Host-interface controller has received a bus reboot	The NAS rebooted itself. If this message appears repeatedly, contact Technical Support.
Host-interface controller has encountered an unknown error	An unidentified error occurred. If this message appears repeatedly, contact Technical Support.
Host-interface controller has encountered a system error	A NAS system error occurred. If this message appears repeatedly, contact Technical Support.
Host-interface controller has encountered a fatal error	Restart the NAS. If this message appears repeatedly, contact Technical Support.
Host-interface controller settings have changed	Result of user action. Normal.

Logical Drive	Corrective Action
Logical drive initialization has started	Result of user action. Normal.
Logical drive initialization has completed	Logical drive is ready to use. Normal.
Logical drive initialization has paused	Initialization paused because of user intervention, schedule or a higher priority background activity.
Logical drive initialization has resumed	Initialization has resumed again after a pause.
Logical drive initialization has stopped	Initialization stopped because of user intervention, schedule or the logical drive was deleted or went critical or offline.
Logical drive initialization marks the logical drive offline	Initialization failure due to a failed disk drive. Replace the disk drive, delete and recreate the logical drive.
Logical drive initialization is aborted due to an internal error.	System resources are low. Reduce system load or restart the NAS.
Logical drive initialization is queued	Initialization has been set manually or by schedule.
A new logical drive has been created	Result of user action. Normal.
Logical drive has been deleted	Result of user action. Normal.
Logical drive has been placed online	The physical drives of the array are restored to online status.
Logical drive has been placed offline. Possible data loss	One or more physical drives in the array went offline.
Logical drive has been set to critical.	One or more physical drives in the array went offline.
Logical drive axle has been placed online	RAID 5 and 6. One of the axles (RAID 5 or 6 arrays) returned on online status.

Media Patrol	Corrective Action
Media patrol is started	Result of settings or user action. Normal.
Media patrol is completed	Normal.
Media patrol is paused	Media patrol paused because of user intervention, schedule or a higher priority background activity.
Media patrol is resumed	Media patrol has resumed again after a pause.

Media patrol is stopped	Media patrol stopped because of user intervention, schedule or the logical drive was deleted or went critical or offline.
Media patrol is aborted due to an internal error.	System resources are low. Reduce system load or restart the NAS.
Media patrol is queued	Media patrol has been set manually or by schedule.
Media patrol is stopped internally	Media patrol stopped because the disk array was deleted or removed.

Online Capacity Expansion	Corrective Action
Online capacity expansion has started	Result of settings or user action. Normal.
Online capacity expansion has completed	Normal.
Online capacity expansion has paused	Expansion paused because of user intervention, schedule or higher priority background activity.
Online capacity expansion has resumed	Expansion has resumed again after a pause or a reboot.
Online capacity expansion has stopped	Expansion stopped because of user intervention, schedule or the logical drive was deleted or went critical or offline.
Online capacity expansion has encountered a physical disk error	Bad block found on a disk drive. Migration will finish. Check the disk drive check table after migration and replace disk drive as needed.
Online capacity expansion is aborted due to an internal error.	System resources are low. Reduce system load or restart the NAS.
Online capacity expansion is queued	Synchronization has been set manually or by schedule.

PDM	Corrective Action
PDM is started	Result of settings or user action. Normal.
PDM is completed	Normal.
PDM is paused	PDM paused because of user intervention, schedule or a higher priority background activity.
PDM is resumed	PDM has resumed again after a pause.
PDM is stopped	PDM stopped because of user

	intervention, schedule or the logical drive was deleted or went critical or offline.
PDM is switched to rebuild.	PDM changed to rebuild because the logical drive went critical
PDM is stopped internally	The destination drive was removed or used for a rebuild.

Physical Disk	Corrective Action
Physical disk is marked online	Disk drive restored to normal operation.
Physical disk is marked as dead.	Disk drive failure. Replace the disk drive.
Physical disk is marked as dead after it was removed and reinserted by the user.	Try forcing the disk online.
Physical disk has been reset	Disk drive reset after error and should function normally.
Physical disk assigned as global spare	Result of settings or user action. Normal.
Physical disk is no longer assigned as global spare	Result of settings or user action. Normal.
Physical disk assigned as dedicated spare	Result of settings or user action. Normal.
Physical disk is no longer assigned as dedicated spare	Result of settings or user action. Normal.
Physical disk has been inserted	A disk drive has been inserted into the NAS system.
Physical disk has been removed	A disk drive has been removed from the NAS system.
Bad sector is found on physical disk	Disk drive has a bad sector. The drive should remap around the bad sector. If this message appears repeatedly, replace the disk drive.
Error is detected in remap sectors	Disk drive has a bad remap sectors. If this message appears repeatedly, replace the disk drive.
Command times out on physical drive	Disk drive not responding to commands. If this message appears repeatedly, replace the disk drive.
Physical disk negotiation speed is decreased.	Disk drive had to reduce its data rate. If this message appears repeatedly, replace the disk drive.
Previously configured disk is	Disk drive may have failed or was

no longer found	removed from the enclosure. Replace or reinstall the disk drive as needed.
A physical disk has encountered an unknown (non-ECC) media error.	Disk drive experienced an unknown error. If this message appears repeatedly, replace the disk drive.
A physical disk has encountered PFA condition	A potentially faulty address or bad sector was found.
A configured dead physical drive has been inserted	The disk drive inserted into the RAID was marked as dead and will not work on the RAID. Replace the disk drive.
A physical drive page 0/1 settings have been changed	Result of settings or user action. Normal.
Physical disk is marked as dead due to removal/failure of reassign sectors/PFA condition/forced offline state	Replace the disk drive.

RAID Level Migration	Corrective Action
RAID Level migration is started	Result of settings or user action. Normal.
RAID Level migration is completed	Normal.
RAID Level migration is paused	Migration paused because of user intervention, schedule or a higher priority background activity.
RAID Level migration is resumed	Migration has resumed again after a pause.
RAID Level migration is stopped	Migration stopped because of user intervention, schedule or the logical drive was deleted or went critical or offline.
RAID Level migration has encountered a physical disk error	Bad block found on a disk drive. Migration will finish. Check the disk drive check table after migration and replace disk drive as needed.
RAID Level migration is aborted due to an internal error.	System resources are low. Reduce system load or restart the NAS.
RAID Level migration is queued	Migration has been set manually or by schedule.
Migration has detected/cleared stale NV Watermark	Watermarks are Progress markers left as the result of interrupted RAID migrations. If the watermark was cleared, migration should finish.

Array was incomplete due to missing NV Watermark	RAID migration was interrupted by a shutdown. If array is online, try migration again. If array is offline, delete and recreate array.
--	--

Rebuild	Corrective Action
Rebuild is started	Result of settings or user action. Normal.
Rebuild is completed	Normal.
Rebuild is paused	Rebuild paused because of user intervention, schedule or a higher priority background activity.
Rebuild is resumed	Rebuild has resumed again after a pause.
Rebuild is stopped	Rebuild stopped because of user intervention, schedule or the logical drive was deleted or the target disk drive encountered an error. If rebuild stopped by the user, restart the rebuild.
Rebuild stopped internally	The logical drive is offline.
Rebuild is aborted due to an internal error.	System resources are low. Reduce system load or restart the NAS.
Rebuild is queued	Rebuild has been set manually or by schedule.
Rebuild marks logical drive synchronized upon rebuild completion	Result of successful rebuild. Normal.

Redundancy Check	Corrective Action
Redundancy Check is started	Redundancy Check has started manually or by schedule.
Redundancy Check is completed	Redundancy Check has finished.
Redundancy Check is paused	Redundancy Check paused because of user intervention, schedule or a higher priority background activity.
Redundancy Check is resumed	Redundancy Check has resumed again after a pause.
Redundancy Check is stopped	Redundancy Check stopped because of user intervention, schedule or the logical drive was deleted or went critical or offline.
Redundancy Check is aborted	System resources are low. Reduce

due to internal error	system load or restart the NAS.
Redundancy Check encountered inconsistent block(s)	Check the logical drive's inconsistent block table. Rebuild the disk array if necessary.
Redundancy Check task is queued	Redundancy Check has been set manually or by schedule.
Redundancy Check task is stopped internally	The logical drive is offline.

Spare Check	Corrective Action
Spare check started on the given spare drive	Result of settings or user action. Normal.
Spare check completed successfully on the given spare drive	Normal.

Spare Drives	Corrective Action
Physical disk assigned as global spare	Result of settings or user action. Normal.
Physical disk is no longer assigned as global spare	Result of settings or user action. Normal.
Global Spare has been deleted	Result of settings or user action. Normal.
Physical disk assigned as dedicated spare	Result of settings or user action. Normal.
Physical disk is no longer assigned as dedicated spare	Result of settings or user action. Normal.
Dedicated Spare has been deleted	Result of settings or user action. Normal.

SMART	Corrective Action
SMART error is received	A disk drive reported a SMART error. If this message appears repeatedly, replace the disk drive.

Synchronization	Corrective Action
Synchronization is started	Result of settings or user action.
Synchronization is completed	Normal.
Synchronization is paused	Synchronization paused because of user intervention, schedule or higher priority background activity.
Synchronization is resumed	Synchronization has resumed again after

	a pause or a reboot.
Synchronization is stopped	Synchronization stopped because of user intervention, schedule or the logical drive was deleted or went critical or offline.
Synchronization is aborted due to an internal error.	System resources are low. Reduce system load or restart the NAS.
Synchronization is queued	Synchronization is already running on another logical drive in the same array.
Synchronization is stopped internally	Synchronization stopped because the disk array was deleted or removed.

System (NAS)	Corrective Action
The system is started	The NAS has been started. Normal.
The system is stopped	The NAS was shut down. Normal.
A nas user has been added	Result of settings or user action. Normal.
A nas user has been deleted	Result of settings or user action. Normal.
A nas user password has been changed	Result of settings or user action. Normal.
A nas group has been added	Result of settings or user action. Normal.
A nas group has been removed	Result of settings or user action. Normal.
The members has been changed in a NAS group	Result of settings or user action. Normal.
Windows/CIFS file service start	
FTP service start	Result of settings or user action. Normal.
NFS for Linux start	Result of settings or user action. Normal.
Fail to start CIFS Protocol	Check the file system status.
Fail to start FTP Protocol	Check the file system status.
Fail to start NFS Protocol	Check the file system status.
Windows/CIFS file service has been stopped	Result of settings or user action. Normal.
FTP Protocol has been stopped	Result of settings or user action. Normal.
NFS Protocol has been stopped	Result of settings or user action. Normal.
NAS settings for windows client has been changed	Result of settings or user action. Normal.
FTP settings has been changed	Result of settings or user action. Normal.
A NAS sharing folder has been created	Result of settings or user action. Normal.

A NAS sharing folder has been removed	Result of settings or user action. Normal.
A NAS sharing folder has been modified	Result of settings or user action. Normal.
NFS setting has been changed	Result of settings or user action. Normal.
CIFS setting has been changed	Result of settings or user action. Normal.
FTP setting has been changed	Result of settings or user action. Normal.
A NAS volume has been created	Result of settings or user action. Normal.
A NAS volume has been deleted	Result of settings or user action. Normal.
File system expansion Start	Result of settings or user action. Normal.
File system expansion Failure	Confirm free capacity. If capacity is enough, restart the NAS. If this message appears repeatedly, contact Technical Support.
File system expansion Done	Normal.
Remote synchronization start	Normal.
Remote synchronization complete	Normal.
Remote synchronization failure	Close all opened file and try again.
Remote synchronization configuration changed	Result of settings or user action. Normal.
NAS mounting points conflict during array transportation	
Create a Snapshot	Result of settings or user action. Normal.
Delete a Snapshot	Result of settings or user action. Normal.
Create Snapshot Fail	Space is not enough to create snapshot. Reduce created snapshot size.
Recover from Snapshot success	Normal.
Recover from Snapshot Fail	The snapshot is over size.

Transition	Corrective Action
Transition is started	Result of settings or user action. Normal.
Transition is completed	Normal.
Transition is paused	Transition paused because of user intervention, schedule or a higher priority background activity
Transition is resumed	Transition has resumed again after a

	pause.
Transition is stopped	Transition stopped because of user intervention or the logical drive was deleted.
Transition was switched to rebuild	Transition changed to rebuild because the logical drive went critical.

Watermark	Corrective Action
Migration has detected stale NV Watermark	Watermarks are Progress markers left as the result of interrupted RAID migrations.
Migration has cleared stale NV Watermark	If the watermark was cleared, migration should finish.

5.2 How to use USB Retrieval to export system information

With the USB Retrieval application, you can easily export the system information to the log file.

1. Download the ShareCenter® Pro DNS-1550-04 USB Retrieval application from CD.
2. Copy “OPAS_general.zip” to your USB Pen Drive.
3. Insert the USB Pen Drive into the USB port on the front panel of NAS.
4. When done, you will be Prompted by a “beep” sound by the system.
5. Remove the USB Pen Drive. The log file that contains the detailed system information will be saved automatically in the “OPAS_OUTPUT” folder of USB Pen drive.

D-Link®

Version 1.00(DI)
July 06, 2011