



Quick Installation Guide

Wireless AC1300 Wave 2 Dual-Band PoE Access Point

This document will guide you through the basic installation process for your new D-Link Wireless AC Access Point.

DAP-2610



Quick Installation Guide
Installationsanleitung
Guide d'installation
Guía de instalación
Guida di Installazione

Documentation also available on
CD and via the D-Link Website

DAP-2610 Quick Install Guide

This installation guide provides basic instructions for installing the DAP-2610 Wireless Access Point on your network. For additional information about how to use the Access Point, please see the User's Manual which is available on the CD included in this package or from the D-Link support website.

System Requirements

Minimum System Requirements:

- CD-ROM Drive
- an Ethernet port, or an installed Ethernet adapter
- Internet Explore 11, Safari 7, Firefox 28, Google Chrome 33 or later versions of these browsers

1. Package Contents

- DAP-2610 802.11ac Power over Ethernet (PoE) Access Point
- Mounting Brackets
- CD-ROM

If any of the above items are missing, please contact your reseller.

NOTE no PSU supplied. To power the units use an D-Link PoE switch or the D-Link DPE-101GI PoE injector.

2. Hardware Overview

LED

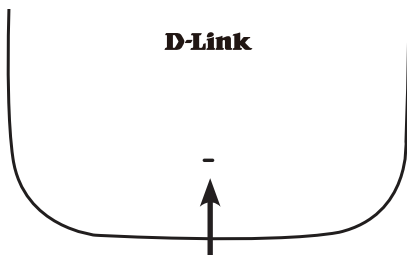

Power/Status LED - Dual color (Red/green)

- . Flash Red during booting up or malfunction
- . Static Green while it's ready/working
- . Solid Red while boot up fail

Interfaces

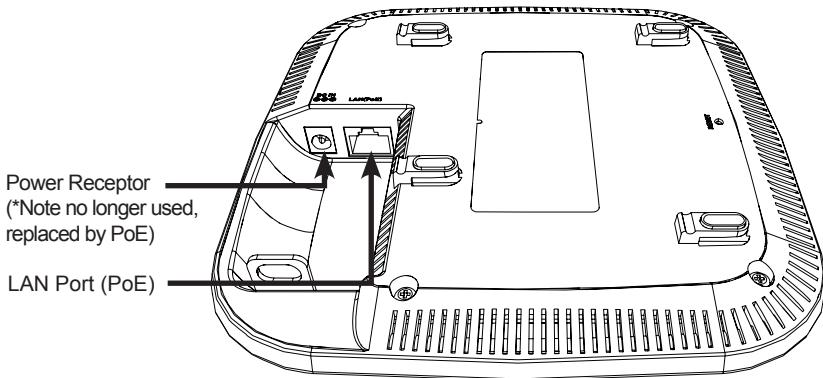

* PoE kit (injector and adapter) is NOT include in the package and it can be purchased with the model name "DPE-101GI".

3. Installation

Power on the access point

To power on the DAP-2610, you can use ONE of the following methods:

1. Plug one end of your Ethernet cable into the LAN port of the DAP-2610, and the other end into a port on a PoE switch.
2. Purchase separately a DPE-101GI PoE injector if you need to connect the Access Point without a PoE Switch.

Configure the access point

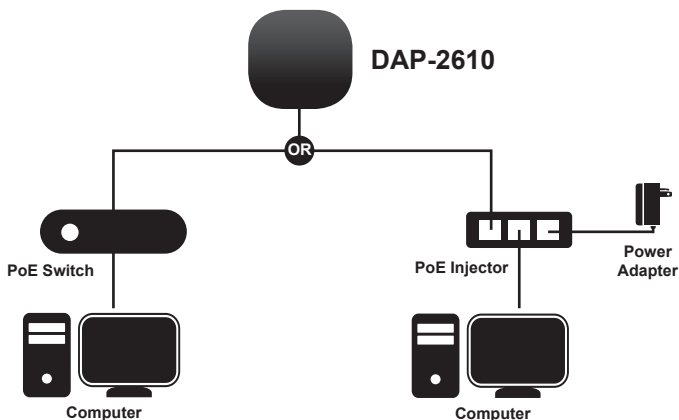

To set up and manage the DAP-2610, use one of the following methods:

1. Connect the access point and your computer via DPE-101GI. Manage the access point from the computer.

Ensure your computer is configured with a static IP address in 192.168.0.0/24 subnet.

Launch a web browser, type the default IP address of the access point (<http://192.168.0.50>) and then press Enter.

Log in to the Administration Web pages. The default login information is:

Username: admin

Password: (Leave the password field blank)

2. Connect the access point and your computer to the same switch. Manage the access point from the computer.

Enter 192.168.0.50 in the address field of your browser, which is the default IP address of the access point.

Log in to the Administration Web pages. The default login information is:

Username: admin

Password: (Leave the password field blank)

Solid wall or ceiling

Installation

1. Place the mounting bracket on a wall or ceiling.
4. Use the supplied screws to attach the mounting ring to the wall.

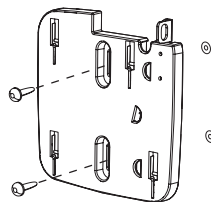
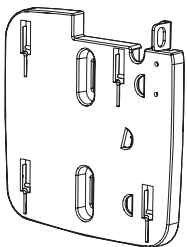

2. Mark the points where you will insert the screws. Take out the mounting ring.
3. Drill holes in the marked points and insert the plastic wall anchors.
5. Plug the Ethernet cable into the LAN port on the access point.
6. To attach the access point to the mounting bracket.

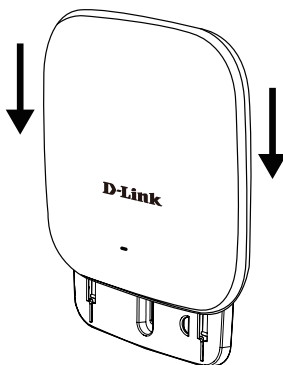
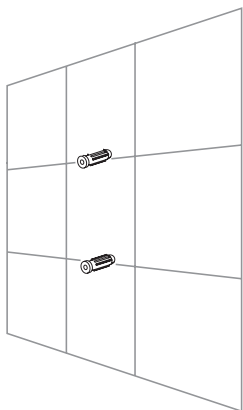

Mounting with a ceiling bracket

Installation

1. Clip two ceiling brackets onto the ceiling panels. Make sure both brackets are in line with each other.

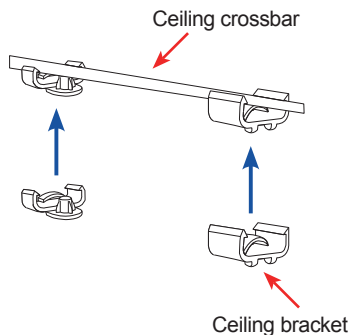

2. Use the provided screws to attach the mounting ring to the ceiling bracket.

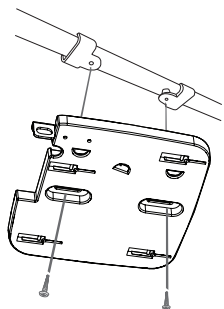

3. Plug the Ethernet cable into the LAN port on the access point.
4. Place the DAP-2610's male bracket in the mounting bracket's female bracket. Click DAP-2610 and the mounting bracket to lock in position.

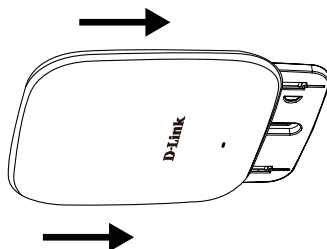

DAP-2610 Installationsanleitung

Diese Installationsanleitung bietet Ihnen grundlegende Anleitungen zur Installation des DAP-2610 Wireless Access Point in Ihrem Netzwerk. Zusätzliche Informationen zur Verwendung des Access Point finden Sie im Benutzerhandbuch, das Ihnen auf der CD, die diesem Paket beiliegt, oder über die D-Link Support-Website zur Verfügung steht.

Systemanforderungen

Mindestsystemanforderungen:

- CD-ROM-Laufwerk
- ein Ethernet-Port oder ein installierter Ethernet-Adapter
- Internal Explore 11, Safari 7, Firefox 28, Google Chrome 33 oder spätere Versionen dieser Browser

1. Packungsinhalt

- DAP-2610 802.11ac Power over Ethernet (PoE) Access Point
- Halterungen
- CD-ROM

Sollte einer der oben aufgeführten Artikel fehlen, wenden Sie sich bitte an Ihren Fachhändler.

HINWEIS: keine Stromversorgungseinheiten im Lieferumfang. Zur Stromversorgung der Einheiten nutzen Sie einen D-Link PoE Switch oder den D-Link DPE-101GI PoE-Injektor.

2. Hardware-Überblick

LED

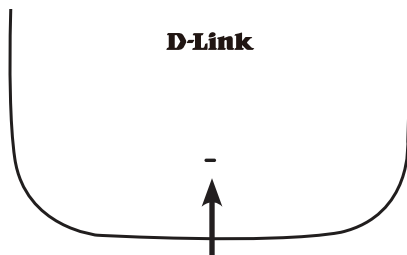

Betriebsanzeige-/Status-LED - Zweifarbige LED-Anzeige (Rot/Grün)

- Blinkt rot während Kaltstart oder Störung
- . Durchgehend grün bei Betriebsbereitschaft/Betrieb
- . Durchgehend rot bei fehlgeschlagenem Hochfahrvorgang

Schnittstellen

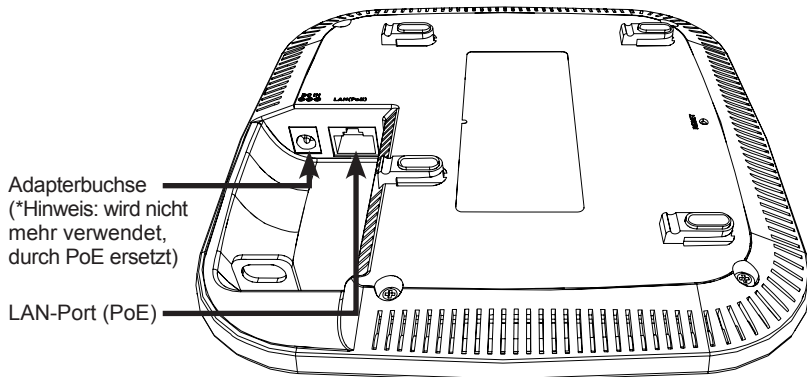

* PoE-Kit (Injektor und Adapter) ist NICHT im Lieferumfang enthalten und kann unter der Modellbezeichnung DPE-101GI gesondert erworben werden.

3. Installation

Access Point - Stromzufuhr

Zur Stromversorgung des DAP-2610 wählen Sie EINE der folgenden Optionen:

1. Stecken Sie ein Ende Ihres Ethernet-Kabels in den LAN-Port des DAP-2610 und das andere Ende in einen Port an einem PoE-Switch.
2. Sie müssen einen DPE-101GI PoE-Injektor gesondert erwerben, soll der Access Point ohne einen PoE Switch angeschlossen werden.

Access Point - Konfiguration

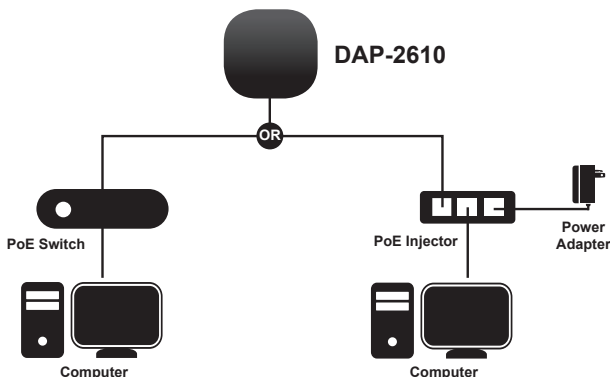

Um Ihren DAP-2610 einzurichten und zu verwalten, verwenden Sie eine der folgenden Methoden:

1. Verbinden Sie den Access Point und Ihren Computer direkt über ein Straight-Through-Kabel (1:1 Kabel) Ethernet-Kabel miteinander. Verwaltung des Access Point über Ihren Computer.

Stellen Sie sicher, dass Ihr Computer mit einer statischen IP-Adresse im Subnetz 192.168.0.0/24 konfiguriert ist.

Öffnen Sie einen Webbrowser, geben Sie die Standard-IP-Adresse des Access Point (<http://192.168.0.50>) ein und drücken Sie dann auf die Eingabetaste.

Melden Sie sich auf den Administrations-Webseiten an. Die standardmäßigen Anmeldeinformationen lauten:

Username (Benutzername): admin

Password (Kennwort): (Lassen Sie das Feld leer)

2. Schließen Sie den Access Point und Ihren Computer an den gleichen Switch an. Führen Sie die Verwaltungsaufgaben für den Access Point von Ihrem Computer aus durch.

Geben Sie in der Adresszeile Ihres Browsers 192.168.0.50 ein. Das ist die Standard-IP-Adresse des Access Point.

Melden Sie sich auf den Administrations-Webseiten an. Die standardmäßigen Anmeldeinformationen lauten:

Username (Benutzername): admin

Password (Kennwort): (Lassen Sie das Feld leer)

Massive Wand oder Decke

Installation

1. Bestimmen Sie einen Platz für die Montagehalterung an einer Wand oder Decke.

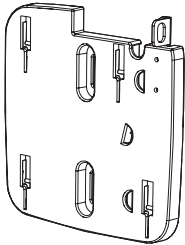

4. Bringen Sie den Befestigungsring mithilfe der mitgelieferten Schrauben an der Wand an.

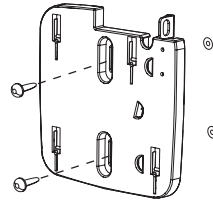

2. Markieren Sie die Punkte, an denen die Schrauben angebracht werden sollen. Entnehmen Sie den Befestigungsring der Verpackung.

5. Stecken Sie das Ethernet-Kabel in den LAN-Port am Access Point.

3. Bohren Sie Löcher an den von Ihnen gekennzeichneten Stellen und setzen Sie die Plastikdübel in die Bohrlöcher ein.

6. Bringen Sie den Access Point auf der Halterung an.

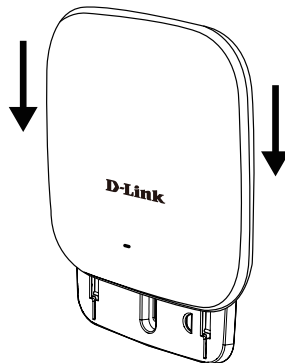
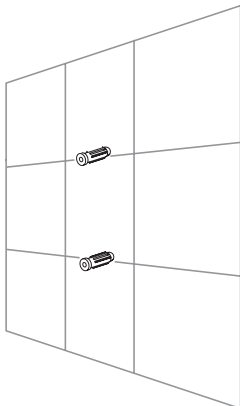

Montage mithilfe einer Deckenhalterung

Installation

1. Bringen Sie zwei Deckenbügelhalterungen an den Deckenpaneelen bzw. Querlatten an. Stellen Sie sicher, dass die beiden Bügelhalterungen entsprechend ausgerichtet sind.

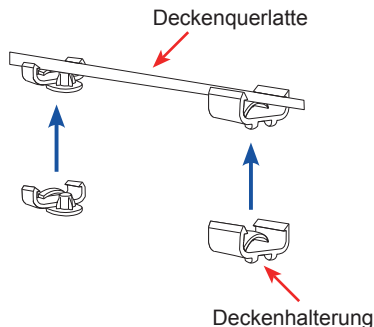

2. Bringen Sie den Befestigungsring mithilfe der mitgelieferten Schrauben an der Deckenhalterung an.

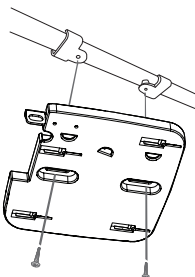

3. Stecken Sie das Ethernet-Kabel in den LAN-Port am Access Point.
4. Setzen Sie die Steckhalterungselemente des DAP-2610 auf die Einstecklöcher der Montagehalterung. Schieben und klicken Sie den DAP-2610 und die Montagehalterung zum Einrasten in der vorgesehenen Position zusammen.

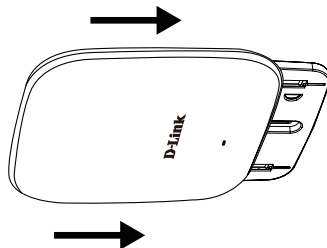

Guide d'installation rapide du DAP-2610

Ce guide d'installation fournit les instructions de base pour l'installation du point d'accès sans fil DAP-2610 sur votre réseau. Pour obtenir des informations complémentaires sur l'utilisation du point d'accès, consultez le Manuel d'utilisation, disponible sur le CD joint à ce coffret, ou sur le site Web d'assistance de D-Link.

Configuration système requise

Configuration minimale requise :

- Lecteur de CD-ROM
- Un port Ethernet ou un adaptateur Ethernet installé
- Internal Explore 11, Safari 7, Firefox 28, Google Chrome 33 ou des versions ultérieures de ces navigateurs

1. Contenu de la boîte

- Point d'accès DAP-2610 802.11ac PoE (alimentation électrique par câble Ethernet)
- Supports de fixation
- CD-ROM

Contactez immédiatement votre revendeur s'il manque l'un des éléments ci-dessus.

REMARQUE : aucune unité d'alimentation fournie. Pour alimenter les appareils, utilisez un commutateur PoE de D-Link ou l'injecteur PoE DPE-101GI de D-Link.

2. Description du matériel

Voyant lumineux

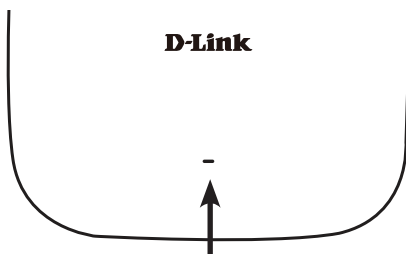

Voyant d'alimentation/état - bicolore (rouge/vert)

- . Clignote en rouge pendant le démarrage ou en cas de dysfonctionnement
- . Reste allumé en vert lorsque le périphérique est prêt/fonctionne
- . Reste allumé en rouge en cas d'échec du démarrage

Interfaces

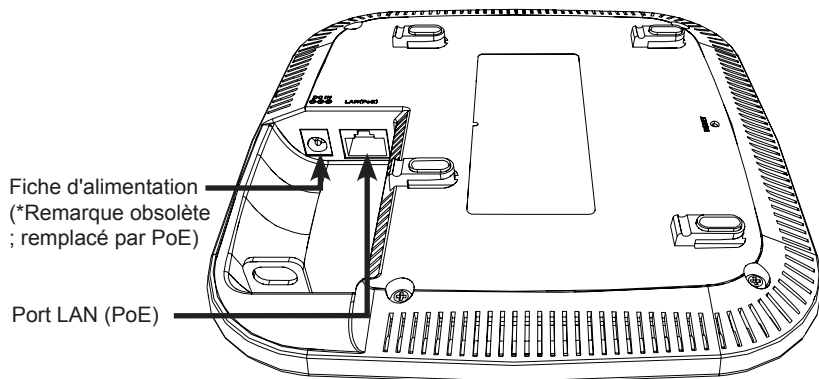

* Le kit PoE (injecteur et adaptateur) n'est PAS inclus dans la boîte. Il porte le nom de modèle « DPE-101GI » et peut être acheté séparément.

3. Installation

Mise sous tension du point d'accès

Pour alimenter le DAP-2610, vous pouvez procéder de l'UNE des façons suivantes :

1. Branchez une extrémité du câble Ethernet au port LAN du DAP-2610 et l'autre extrémité au port d'un commutateur PoE.
2. Achetez séparément un injecteur PoE DPE-101GI si vous devez connecter le point d'accès sans un commutateur PoE.

Configuration du point d'accès

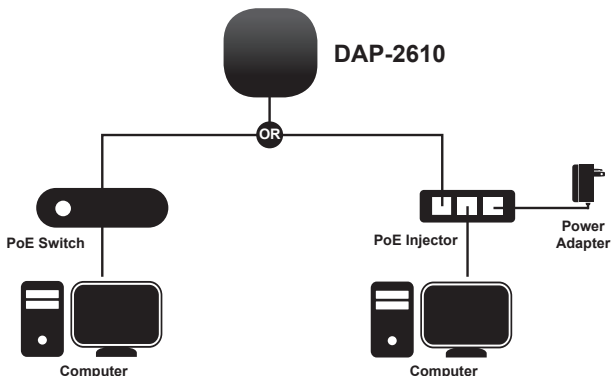

Pour configurer et gérer le DAP-2610, vous pouvez procéder de l'une des façons suivantes :

1. Connectez le point d'accès et votre ordinateur directement à l'aide d'un câble Ethernet droit. Gérez le point d'accès à partir de l'ordinateur.

Assurez-vous que votre ordinateur est configuré avec une adresse IP statique dans le sous-réseau 192.168.0.0/24.

Lancez un navigateur web, saisissez l'adresse IP par défaut du point d'accès (<http://192.168.0.50>), puis appuyez sur Entrée.

Connectez-vous à la page d'administration Web. Par défaut, les informations d'ouverture de session sont les suivantes :

Nom d'utilisateur : admin

Mot de passe : (Laissez le champ du mot de passe vide)

2. Connectez le point d'accès et votre ordinateur au même commutateur. Gérez le point d'accès à partir de l'ordinateur.

Saisissez 192.168.0.50, l'adresse IP par défaut du point d'accès, dans le champ d'adresse de votre navigateur.

Connectez-vous à la page d'administration Web. Par défaut, les informations d'ouverture de session sont les suivantes :

Nom d'utilisateur : admin

Mot de passe : (Laissez le champ du mot de passe vide)

Paroi solide ou plafond

Installation

1. Placez le support de montage sur un mur ou au plafond.
4. Utilisez les vis fournies pour fixer le support de montage au mur.

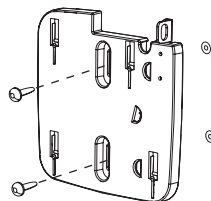
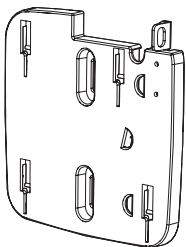

2. Marquez les points où vous allez insérer les vis. Enlevez le support de montage.
3. Percez des trous dans les points marqués et insérez les chevilles en plastique.
5. Branchez le câble Ethernet au port LAN du point d'accès..
6. Pour fixer le point d'accès au support de montage.

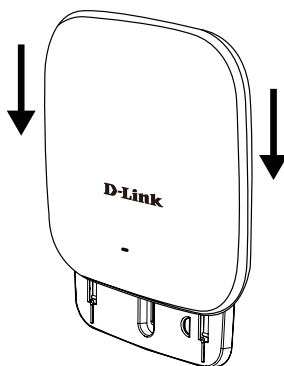
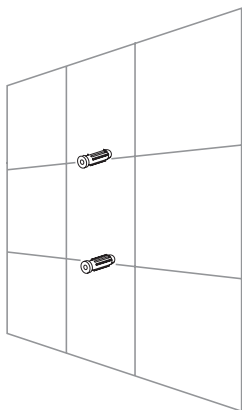

Montage avec un support de fixation au plafond

Installation

1. Accrochez deux supports de fixation au panneau du plafond. Assurez-vous que les deux supports sont alignés l'un par rapport à l'autre.

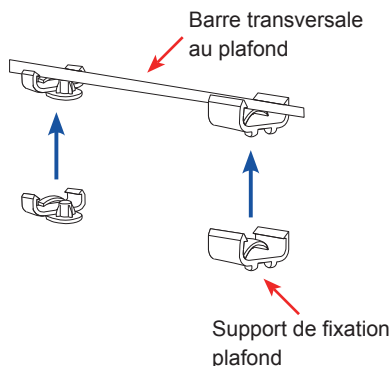

2. Utilisez les vis fournies pour fixer le support de montage au support de fixation du plafond.

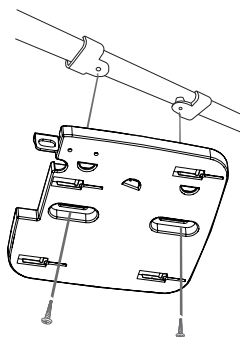

3. Branchez le câble Ethernet au port LAN du point d'accès..
4. Insérez le support mâle du DAP-2610 dans le support femelle du support de montage. Appuyez sur le DAP-2610 et le support de montage jusqu'à ce qu'ils s'enclenchent en place.

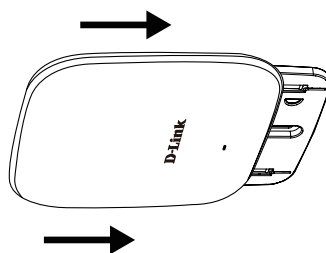

Guía de instalación rápida de DAP-2610

Esta guía de instalación proporciona instrucciones básicas para la instalación del punto de acceso inalámbrico DAP-2610 en su red. Para obtener información adicional acerca de cómo utilizar el punto de acceso, consulte el Manual del usuario disponible en el CD incluido en el paquete o en el sitio web de asistencia de D-Link.

Requisitos del sistema

Requisitos mínimos del sistema:

- Unidad de CD-ROM
- Un puerto Ethernet o un adaptador Ethernet instalado
- Internet Explore 11, Safari 7, Firefox 28, Google Chrome 33 o versiones posteriores de estos exploradores

1. ¿Qué contiene la caja?

- DAP-2610 Punto de acceso 802.11ac con alimentación a través de Ethernet (PoE).
- Soportes de montaje
- CD-ROM

Si falta cualquiera de los componentes anteriores, póngase en contacto con el proveedor.

Tenga en cuenta que el dispositivo se suministra SIN fuente de alimentación. Para la alimentación del mismo, utilice un conmutador PoE de D-Link o el inyector PoE DPE-101GI de D-Link.

2. Descripción general del hardware

LED

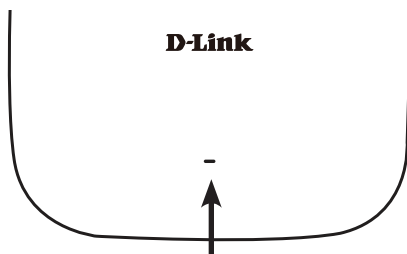

LED de alimentación/estado: dos colores (rojo/verde)

- . Parpadeo en rojo durante el arranque o cuando funciona mal
- . Verde fijo mientras está preparado/en funcionamiento
- . Rojo continuo cuando falla el arranque

Interfaces

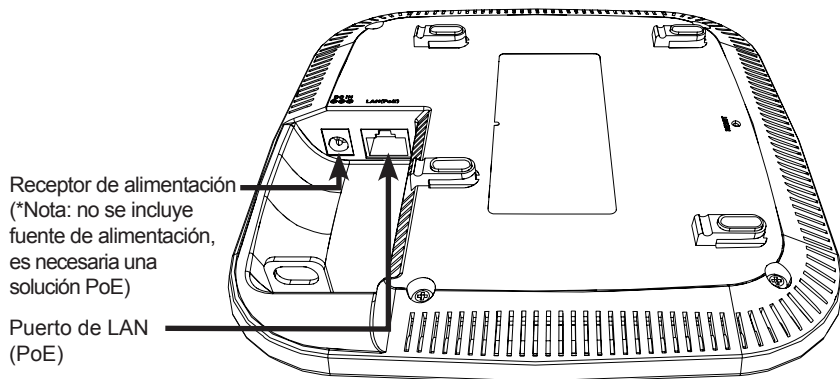

* El kit PoE (inyector y adaptador) NO se incluye en el paquete, pero se puede adquirir por separado. La referencia del mismo es "DPE-101GI".

3. Instalación

Encendido del punto de acceso

Para alimentar el DAP-2610, puede utilizar UNO de los métodos siguientes:

1. Enchufar un extremo del cable Ethernet al puerto de LAN del DAP-2610 y el otro extremo a un puerto en un conmutador PoE.
2. Adquiera un inyector PoE, DPE-101GI, por separado para alimentar el punto de acceso sino dispone de un conmutador PoE.

Configuración del punto de acceso

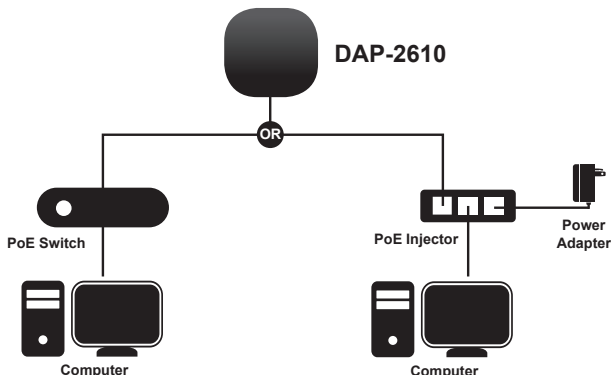

Para configurar y gestionar el DAP-2610, utilice uno de los métodos siguientes:

1. Conectar el punto de acceso y el ordenador directamente a través de un cable Ethernet directo. Gestione el punto de acceso desde el ordenador.

Asegúrese de que el ordenador se ha configurado con una dirección IP estática en la subred 192.168.0.0/24.

Inicie un explorador de web, escriba la dirección IP predeterminada del punto de acceso (<http://192.168.0.50>) y, a continuación, pulse Intro.

Inicie sesión en las páginas web de administración. La información predeterminada de inicio de sesión es:

Nombre de usuario: admin

Contraseña: (deje en blanco el campo de la contraseña)

2. Conectar el punto de acceso y el ordenador al mismo interruptor. Gestione el punto de acceso desde el ordenador.

En el campo de dirección del explorador, escriba 192.168.0.50, que es la dirección IP predeterminada del punto de acceso.

Inicie sesión en las páginas web de administración. La información predeterminada de inicio de sesión es:

Nombre de usuario: admin

Contraseña: (deje en blanco el campo de la contraseña)

Pared sólida o techo

Instalación

1. Coloque el soporte de montaje en una pared o en el techo.

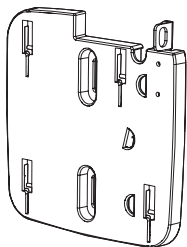

4. Utilice los tornillos suministrados para acoplar el aro de montaje a la pared.

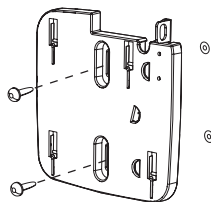

2. Marque los puntos en los que introducirá los tornillos. Saque el aro de montaje.

3. Taladre los orificios en los puntos marcados e introduzca los anclajes de pared de plástico.

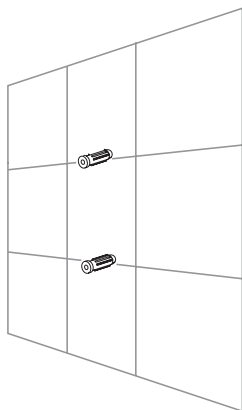

5. Enchufe el cable Ethernet en el puerto LAN en el punto de acceso.

6. Acoplar el punto de acceso al soporte de montaje.

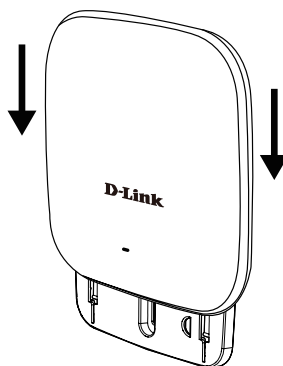

Montaje con un soporte para techo

Instalación

1. Ajuste dos soportes para techo en los paneles del techo. Asegúrese de que ambos soportes están alineados entre sí.

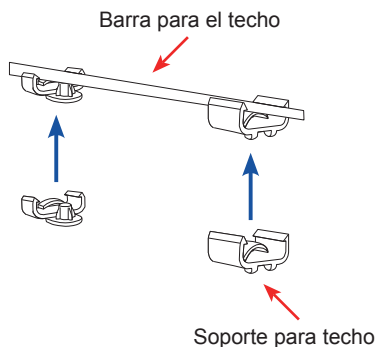

2. Utilice los tornillos suministrados para acoplar el aro de montaje al soporte para techo.

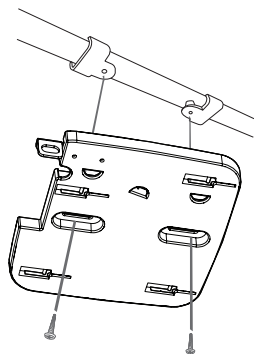

3. Enchufe el cable Ethernet en el puerto LAN en el punto de acceso.
4. Coloque el soporte macho del DAP-2610 en el soporte hembra del soporte de montaje. Haga clic en el DAP-2610 y en el soporte de montaje para bloquearlo en su posición.

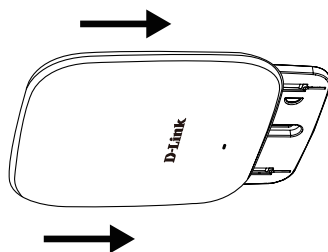

Guida di installazione rapida di DAP-2610

In questa guida di installazione sono riportate le istruzioni di base per installare il punto di accesso wireless DAP-2610 in rete. Per ulteriori informazioni sull'utilizzo del punto di accesso, consultare il manuale utente disponibile sul CD incluso nella confezione o scaricabile dal sito Web di supporto di D-Link.

Requisiti di sistema

Requisiti minimi di sistema:

- Unità CD-ROM
- Porta Ethernet o scheda Ethernet installata
- Internet Explore 11, Safari 7, Firefox 28, Google Chrome 33 o versioni successive di questi browser

1. Contenuto della confezione

- DAP-2610 802.11ac Punto di accesso Power over Ethernet (PoE)
- Staffe per il montaggio
- CD-ROM

Se uno o più degli articoli sopra elencati risultano mancanti, rivolgersi al rivenditore.

NOTA nessuna PSU fornita. Per alimentare le unità utilizzare uno switch PoE D-Link o l'iniettore PoE D-Link DPE-101GI.

2. Panoramica hardware

LED

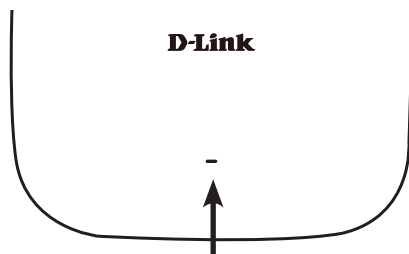

LED Power/Status - A due colori (rosso/verde)

- . Lampeggia in rosso durante l'avvio o in caso di guasto
- . È verde fisso quando il dispositivo è pronto/funzionante
- . È rosso fisso in caso di mancato avvio

Interfacce

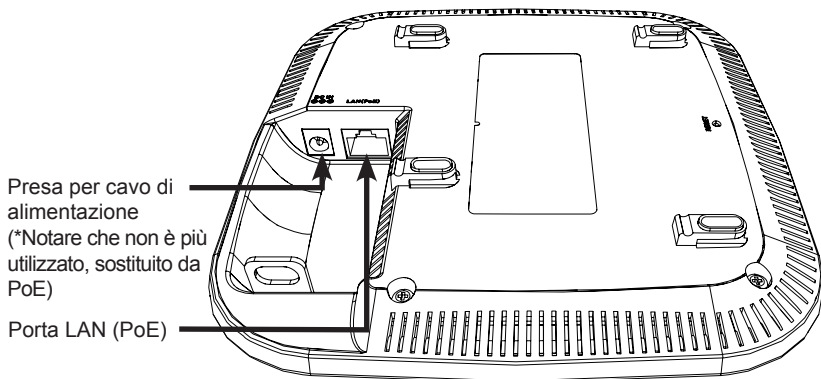

* Kit PoE (iniettore e adattatore) NON incluso nel pacchetto; può essere acquistato con il nome del modello "DPE-101G1".

3. Installazione

Accensione del punto di accesso

Per accendere il dispositivo DAP-2610, è possibile utilizzare UNO dei seguenti metodi:

1. Collegare un'estremità del cavo Ethernet alla porta LAN del dispositivo DAP-2610 e l'altra estremità a una porta di uno switch PoE.
2. Acquistare separatamente un iniettore PoE DPE-101GI per collegare il punto d'accesso senza uno Switch PoE.

Configurazione del punto di accesso

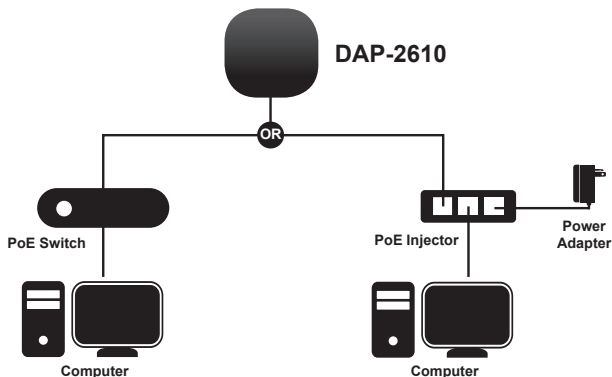

Per configurare e gestire il dispositivo DAP-2610, è possibile utilizzare uno dei seguenti metodi:

1. Collegare il punto di accesso al computer direttamente tramite un cavo Ethernet diritto. Gestire il punto di accesso dal computer.

Verificare che il computer sia configurato con un indirizzo IP statico nella subnet 192.168.0.0/24.

Avviare un browser Internet, digitare l'indirizzo IP predefinito del punto di accesso (<http://192.168.0.50>) e quindi premere Invio.

Accedere alle pagine Web di amministrazione. Le informazioni di default per l'accesso sono le seguenti:

Nome utente: admin

Password: (lasciare vuoto il campo Password)

2. Collegare il punto di accesso e il computer allo stesso switch. Gestire il punto di accesso dal computer.

Nel campo relativo all'indirizzo del browser immettere 192.168.0.50, che corrisponde all'indirizzo IP di default del punto di accesso.

Accedere alle pagine Web di amministrazione. Le informazioni di default per l'accesso sono le seguenti:

Nome utente: admin

Password: (lasciare vuoto il campo Password)

Su parete solida o a soffitto

Installazione

1. Installare la staffa per il montaggio su una parete o a soffitto.

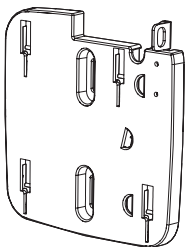

4. Utilizzare le viti fornite per fissare l'anello di montaggio alla parete.

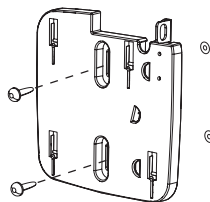

2. Contrassegnare i punti in cui verranno inserite le viti. Estrarre l'anello di montaggio.

3. Praticare con il trapano dei punti in corrispondenza dei punti contrassegnati e inserirvi i tasselli in plastica.

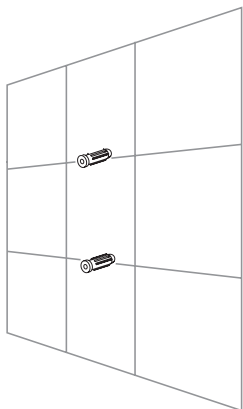

5. Collegare il cavo Ethernet alla porta LAN del punto di accesso.

6. Fissare il punto di accesso alla staffa di montaggio.

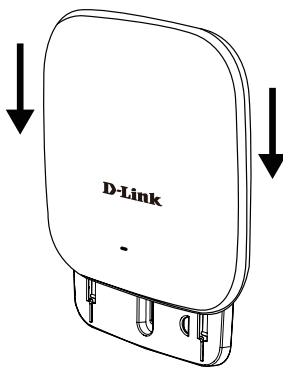

Montaggio con un staffa a soffitto

Installazione

1. Agganciare le due staffe sui pannelli a soffitto, assicurandosi che siano allineate.

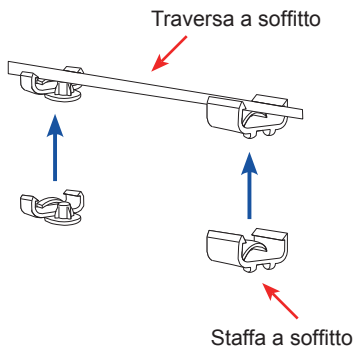

2. Utilizzare le viti fornite per fissare l'anello di montaggio alla staffa a soffitto.

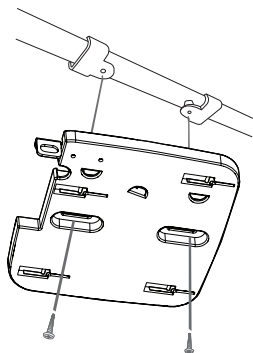

3. Collegare il cavo Ethernet alla porta LAN del punto di accesso.

4. Inserire la staffa maschio del dispositivo DAP-2610 nella parte femmina della staffa di montaggio. Inserire bene il dispositivo DAP-2610 nella staffa di montaggio per bloccarlo in posizione.

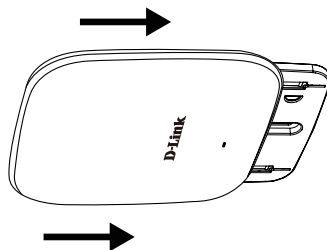

FREE Central WiFiManager Software

DOWNLOAD NOW

DLINK.COM/WIFIDOWNLOAD

With the easy-to-use web-based interface you can...

- Configure once and apply to multiple Access Points
- Install on Windows PC
- Access on any device using a web-browser, e.g. smartphone or notebook
- Utilise user authentication and access control
- Monitor your entire wireless network in real time¹
- Access detailed reports
- Optimise your bandwidth

FREE Central WiFiManager User Interface



Supports multiple languages



1. see overleaf for selected product information.

Connect to More
www.dlink.com/wifidownload

D-Link[®]
Building Networks for People

FREE Central WiFiManager

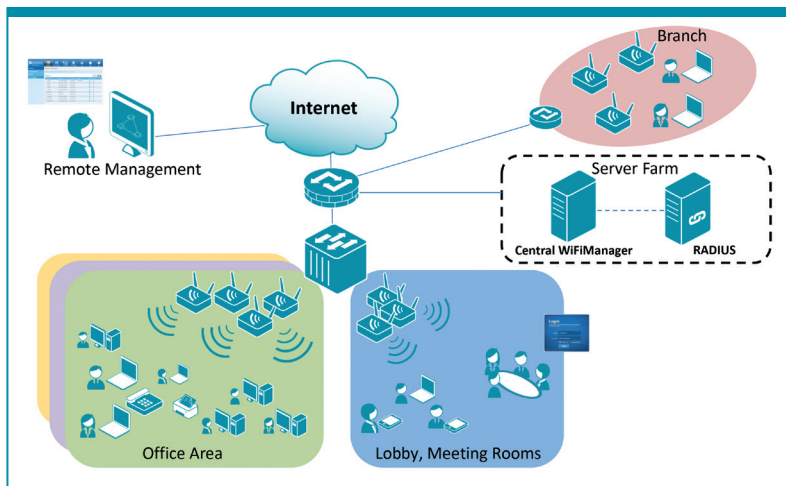

Available on the following products²:

DAP-2695

Wireless AC1750 Indoor Access Point

Designed to support small to medium business or enterprise environments. Secure, manageable dual-band wireless LAN options.



DAP-2610

Wireless AC1200 Indoor Ceiling Access Point

Providing enhanced speeds of Wireless AC as well as dual-band connectivity to reduce interference, for a faster and more efficient network.



DAP-2310

Wireless N Indoor Access Point

Ideal for creating or expanding capacity of a wireless network; mainly used in high-traffic areas such as airports, coffee shops, sports venues, and university campus deployments.



DAP-2360

Wireless N PoE Access Point

For advanced indoor installations, this high-speed Access Point has integrated PoE support, allowing installation in areas where power outlets are not readily available.



DAP-2690

Wireless N Simultaneous Dual-Band PoE Access Point

Designed for indoor installation where power outlets are not readily available. Enables deployment of a highly manageable, robust and secure wireless network.



DAP-2330

Wireless N PoE Access Point

Ideal for wireless networks in high-traffic areas such as airports, coffee shops, shopping centres, sporting venues, hotels and campus deployments. PoE offers installation where power outlets are not available.



2. Visit dlink.com for selected Hardware & Software versions.

Connect to More
www.dlink.com/wifidownload

D-Link[®]
 Building Networks for People

NOTES

D-Link®



Ver. 1.00(EU)_130x183
2016/12/28
6AP2610Q..E1G