

DAP-2660

Version 1.01

Wireless AC1200
Dual Band Gigabit PoE Access Point

User Manual

Business Class Networking

Table of Contents

Product Overview	4	Advanced Settings	24
Introduction	4	Performance	25
Features.....	5	Wireless Resource Control	27
Package Contents.....	6	Multi-SSID.....	29
System Requirements	6	VLAN.....	31
Hardware Overview	7	VLAN List.....	31
LEDs.....	7	Port List.....	32
Connections	7	Add/Edit VLAN	33
Basic Installation	8	PVID Settings.....	34
Hardware Setup	8	Intrusion	35
Method 1 - PoE with PoE Switch or Router.....	8	Schedule	36
Method 2 - PoE without PoE Switch or Router.....	9	Internal RADIUS Server	37
Method 3 - No PoE.....	10	ARP Spoofing Prevention	38
Web User Interface	11	Bandwidth Optimization	39
Wireless	12	AP Array	41
Access Point Mode	12	AP Array Scan	41
WDS with AP Mode.....	14	Configuration Settings.....	42
WDS Mode	16	Auto-RF.....	46
Wireless Client Mode.....	18	Load Balance	47
Wireless Security	19	Captive Portal	48
Wired Equivalent Privacy (WEP)	19	Authentication Settings - Ticket	48
Wi-Fi Protected Access (WPA / WPA2).....	20	Authentication Settings - User/Password	49
LAN	22	Authentication Settings - Remote RADIUS.....	50
IPv6	23	Authentication Settings - LDAP	51
		Authentication Settings - POP3.....	52
		Login Page Upload	53

Web Redirection.....	54	Login Settings	74
DHCP Server	55	Console Settings	74
Dynamic Pool Settings.....	55	SNMP Settings	75
Static Pool Setting	56	Administration.....	76
Current IP Mapping List.....	57	Central WiFiManager Settings.....	76
Filters.....	58	Firmware and SSL Upload.....	77
Wireless MAC ACL.....	58	Configuration File Upload	78
WLAN Partition	59	Time and Date Settings	79
Traffic Control.....	60	Configuration and System.....	80
Uplink/Downlink Setting	60	System Settings.....	81
QoS.....	61	Help	82
Traffic Manager.....	62	Knowledge Base	83
Status	63	Wireless Basics	83
Device Information	64	Wireless Installation Considerations.....	84
Client Information	65	Troubleshooting	85
WDS Information Page	66	Why can't I access the web-based configuration utility?	85
Channel Analyze	67	What can I do if I forgot my password?.....	85
Stats Page.....	68	How to check your IP address?	86
Ethernet Traffic Statistics.....	68	How to statically assign an IP address?.....	87
WLAN Traffic Statistics.....	69	Technical Specifications	88
Log	70	Antenna Pattern	89
View Log.....	70		
Log Settings.....	71		
Maintenance Section	72		
Administration.....	73		
Limit Administrator	73		
System Name Settings.....	74		

Product Overview

Introduction

D-Link, an industry pioneer in wireless networking, introduces a solution for businesses seeking to deploy next generation 802.11ac LANs. D-Link unveils its new DAP-2660, designed specifically for environments with high traffic areas such as airports, coffee shops, shopping centers, sporting venues, and school campuses to provide secure and manageable dual band wireless network options for network administrators.

Versatile Access Point

The DAP-2660 Access Point allows network administrators to deploy a highly manageable and extremely robust dual band wireless network. For advanced installations, this new high-speed Access Point has integrated 802.3af Power over Ethernet (PoE) support, allowing installation of this device in areas where power outlets are not readily available. In addition to bridging 802.11ac and 802.11b/g/n wireless networks, the DAP-2660 can bridge to wired networks with its integrated Gigabit (10/100/1000Mbps) Ethernet port.

Enhanced Performance

The DAP-2660 delivers reliable wireless performance with maximum wireless signal rates of up to 1200Mbps. This, coupled with support for Wi-Fi Multimedia™ (WMM) Quality of Service features, makes it an ideal access point for audio, video, and voice applications.

Security

To help maintain a secure wireless network, the DAP-2660 provides the latest in wireless security technologies by supporting both Personal and Enterprise versions of WPA and WPA2 (802.11i) with support for RADIUS server back end. To further protect your wireless network, MAC Address Filtering, Wireless LAN segmentation, Disable SSID Broadcast, Rogue AP Detection, and Wireless Broadcast Scheduling are also included.

* Maximum wireless signal rate derived from IEEE Standard 802.11ac, 802.11g, 802.11a, and 802.11n specifications. Actual data throughput will vary. Network conditions and environmental factors, including volume of network traffic, building materials and construction, and network overhead, lower actual data throughput rate. Environmental conditions will adversely affect wireless signal range.

Features

- Provide Ethernet to Wireless LAN bridge fully IEEE 802.3/u/ab compatible on the Ethernet side and fully interoperable with IEEE 802.11ac and b/g/n compliant equipment
- Compatible with IEEE 802.11b high rate standard to provide wireless 11Mbps data rate*
- Compatible with IEEE 802.11g higher speed standard to provide wireless 54Mbps data rate*
- Compatible with IEEE 802.11a higher speed standard to provide wireless 54Mbps data rate*
- Compatible with IEEE 802.11n higher speed standard to provide wireless 300Mbps data rate*
- Compatible with IEEE 802.11ac higher speed standard to provide wireless 900Mbps data rate*
- Operation at 2.4~2.5GHz and 5.15~5.85GHz** frequency band to meet worldwide regulations
- Supports IEEE 802.11ac and b/g/n wireless data encryption with 64/128-bit WEP for security
- Supports enhanced security – WPA-PSK and WPA2-PSK, RADIUS client, and Cipher negotiation
- Allows auto fallback data rate for reliability, optimized throughput and transmission range
- Web-based configuration and management
- Supports 802.3af PoE
- Supports 802.3az
- Supports one Gigabit Ethernet port
- AP Mode, WDS Mode, WDS with AP, and Wireless Client Mode
- Supports SNMP v1,v2,v3
- Support Trap server (SNMP v1, v2c)
- Support Central WiFiManager
- Support AP Array and AP Array Setup Tool

* Maximum wireless signal rate derived from IEEE Standard 802.11ac, 802.11g, 802.11a, and 802.11n specifications. Actual data throughput will vary. Network conditions and environmental factors, including volume of network traffic, building materials and construction, and network overhead, lower actual data throughput rate. Environmental conditions will adversely affect wireless signal range.

**Please note that operating frequency ranges vary depending on the regulations of individual countries and jurisdictions. The DAP-2660 isn't supported in the 5.25~5.35GHz and 5.47 ~ 5.725GHz frequency ranges in some regions.

Package Contents

- DAP-2660 Access Point
- Power Adapter
- Mounting Plate and Hardware
- Ethernet Cable
- CD (with software and user manual)

Note: *Using a power supply with a different voltage rating than the one included with the DAP-2660 will cause damage and void the warranty for this product.*

System Requirements

- Computers with Windows®, Macintosh®, or Linux-based operating systems with an installed Ethernet Adapter
- Internet Explorer Version 7.0, Chrome 12, Safari 4, or Firefox 12 and above (for web-based configuration)

Hardware Overview

LEDs



1	Power/Status	Solid Red	Indicates the access point has malfunctioned.
		Blinking Red	This LED will blink during boot-up.
		Solid Green	Indicates that the DAP-2660 is working properly.
		Blinking Green	This light will blink green during data transmission.

Connections



2	Power Receptor	Connect the supplied power adapter.
3	LAN (PoE) Port	Connect to a Power over Ethernet (PoE) switch or router via an Ethernet cable.
4	Reset Button	Press and hold for five seconds to reset the access point to the factory default settings. Press and hold for one second to reboot the access point.

Basic Installation

Hardware Setup

To power the access point, you can use one of the following 3 methods:

Method 1 - Use if you have a PoE switch or router.

Method 2 - Use if you do not have a PoE switch or router and do not have a power outlet near the location of the access point.

Method 3 - Use if you do not have a PoE switch or router and have a power outlet near the location of the access point.

Method 1 - PoE with PoE Switch or Router

1. Connect one end of your Ethernet cable to the LAN (PoE) port on the access point.
2. Connect the other end into one port on a PoE switch or router.



Method 2 - PoE without PoE Switch or Router

1. Connect one end of an Ethernet cable into the **Data In** port on the PoE base unit and the other end into one port on your switch, router, or computer.
2. Connect one end of an Ethernet cable into the **P+Data Out** port on the PoE base unit and the other end into the LAN (PoE) port on the Access Point.
3. Use the supplied power adapter. Connect the power adapter to the **Power In** receptor on the PoE adapter.
4. Connect the power cable to the power adapter and then connect the other end into a power outlet.

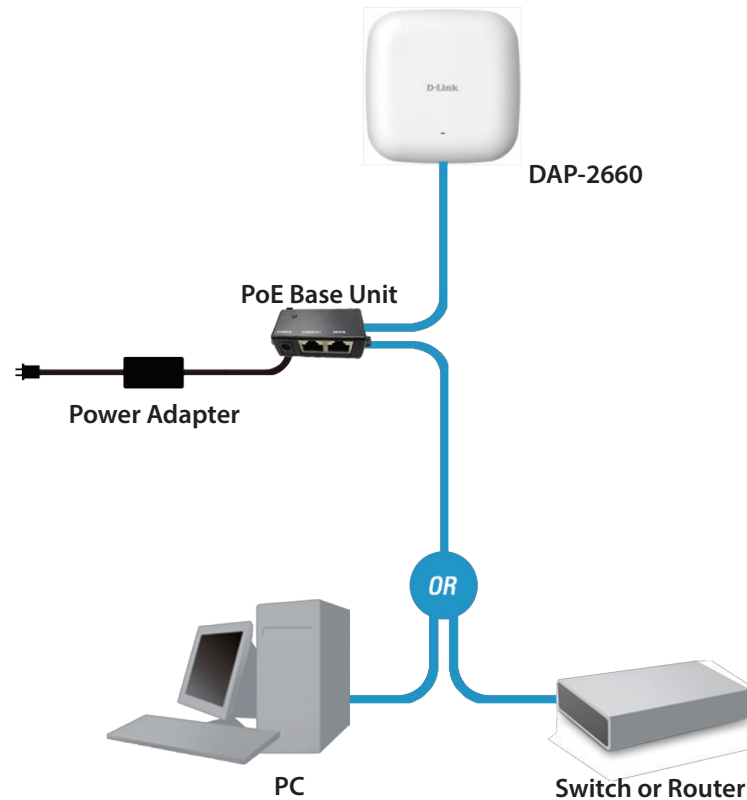

Method 3 - No PoE

1. Connect one end of your Ethernet cable into the LAN (PoE) port and then connect the other end to a switch, router, or computer.
2. Use the supplied power adapter. Connect the power adapter to the Power receptor on the Access Point.
3. Connect the power cable to the power adapter and then connect the other end into a power outlet.

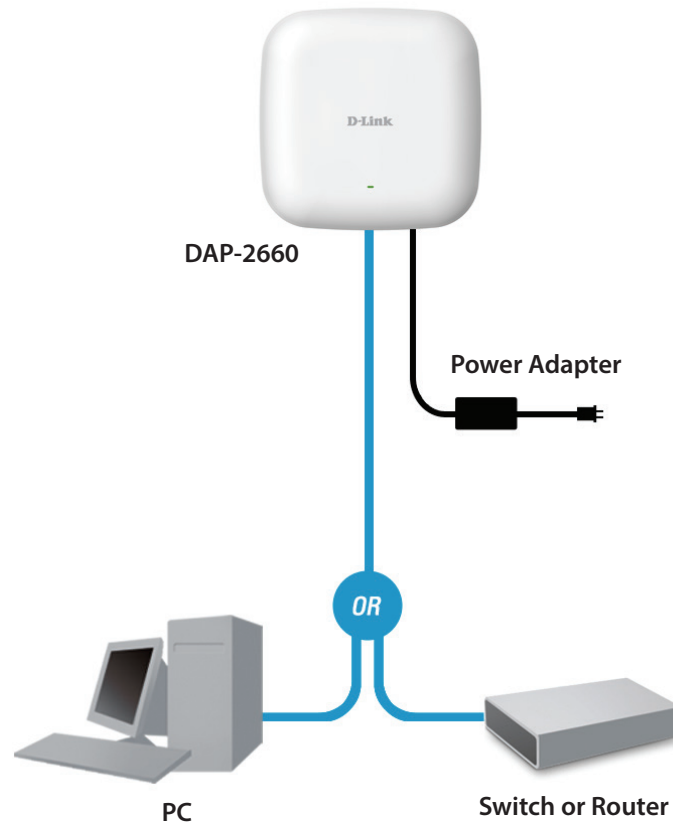

Web User Interface

The DAP-2660 supports an elaborate web user interface where the user can configure and monitor the device. Most of the configurable settings are located in the left menu of the web GUI which contains section called **Basic Settings**, **Advanced Settings** and **Status**.

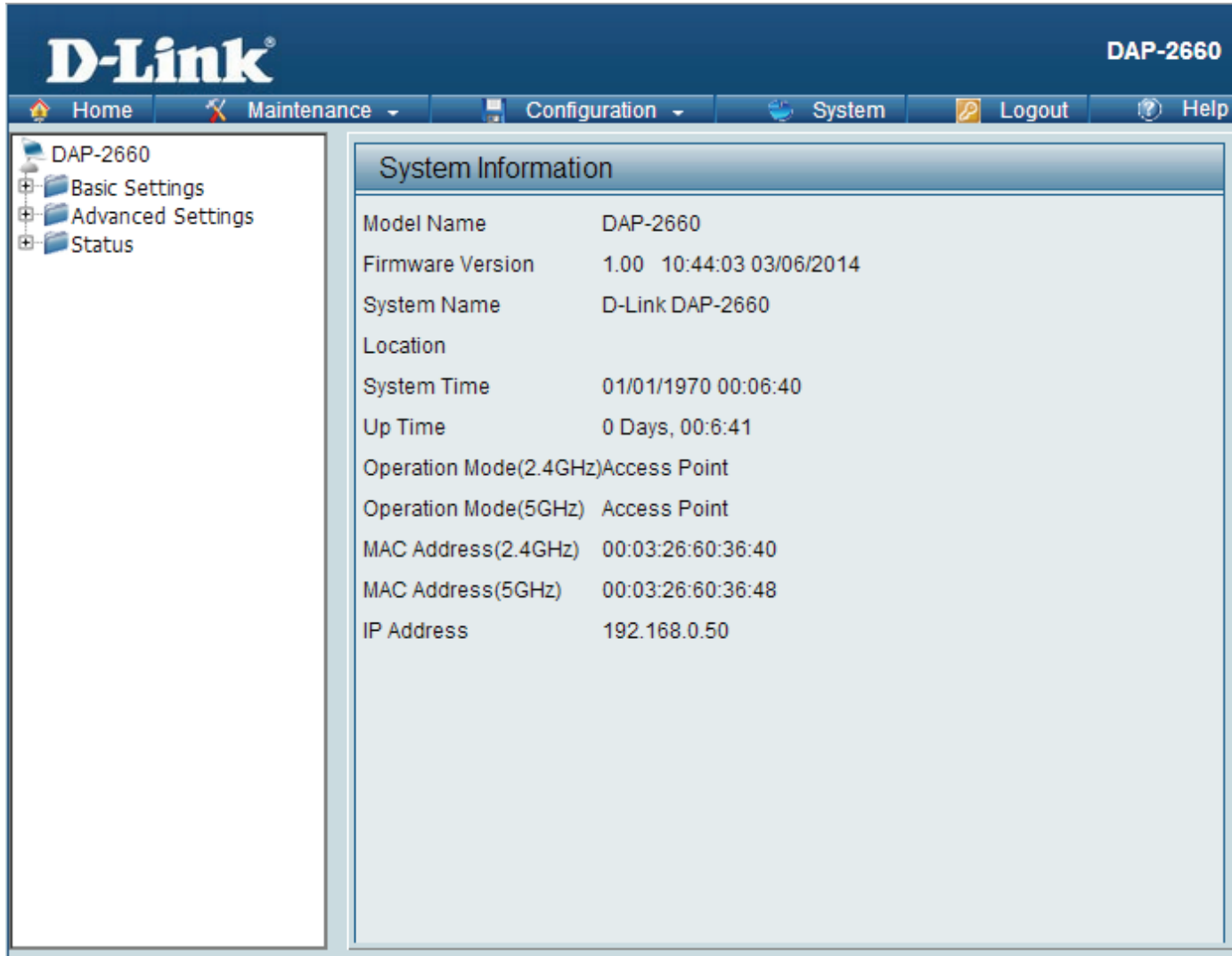

The screenshot displays the web user interface for the D-Link DAP-2660. The interface features a dark blue header with the D-Link logo on the left and the device model 'DAP-2660' on the right. Below the header is a navigation bar with buttons for Home, Maintenance, Configuration, System, Logout, and Help. A left-hand menu contains expandable sections for DAP-2660, Basic Settings, Advanced Settings, and Status. The main content area is titled 'System Information' and displays the following details:

Model Name	DAP-2660
Firmware Version	1.00 10:44:03 03/06/2014
System Name	D-Link DAP-2660
Location	
System Time	01/01/1970 00:06:40
Up Time	0 Days, 00:6:41
Operation Mode(2.4GHz)	Access Point
Operation Mode(5GHz)	Access Point
MAC Address(2.4GHz)	00:03:26:60:36:40
MAC Address(5GHz)	00:03:26:60:36:48
IP Address	192.168.0.50

Wireless

On the wireless settings page, you can setup the basic wireless configuration for the access point. The user can choose from 4 different wireless modes:

Access Point - Used to create a wireless LAN

WDS with AP - Used to connect multiple wireless networks while still functioning as a wireless access point

WDS - Used to connect multiple wireless networks

Wireless Client - Used when the access point needs to act as a wireless network adapter for an Ethernet enabled device

Access Point Mode

Wireless Band: Select either **2.4 GHz** or **5 GHz** from the drop-down menu.

Mode: Select **Access Point** from the drop-down menu.

Network Name (SSID): Service Set Identifier (SSID) is the name designated for a specific wireless local area network (WLAN). The SSID's factory default setting is **dlink**. The SSID can be easily changed to connect to an existing wireless network or to establish a new wireless network. The SSID can be up to 32 characters and is case-sensitive.

SSID Visibility: Select **Enable** to broadcast the SSID across the network, thus making it visible to all network users. Select **Disable** to hide the SSID from the network.

Auto Channel Selection: This feature when enabled automatically selects the channel that provides the best wireless performance. The channel selection process only occurs when the AP is booting up. To manually select a channel, set this option to Disable and select a channel from the drop-down menu.

The screenshot displays the D-Link DAP-2660 configuration interface. The main content area is titled "Wireless Settings" and contains the following fields and options:

- Wireless Band:** 2.4GHz (dropdown)
- Mode:** Access Point (dropdown)
- Network Name (SSID):** dlink (text input)
- SSID Visibility:** Enable (dropdown)
- Auto Channel Selection:** Enable (dropdown)
- Channel:** 1 (dropdown)
- Channel Width:** 20 MHz (dropdown)
- Captive Profile:** Disable (dropdown)
- Authentication:** Open System (dropdown)
- Key Settings:**
 - Encryption:** Disable Enable
 - Key Type:** HEX (dropdown)
 - Key Size:** 64 Bits (dropdown)
 - Key Index(1~4):** 1 (dropdown)
 - Network Key:** (text input)
 - Confirm Key:** (text input)

A "Save" button is located at the bottom right of the settings area. The background shows a navigation menu with "Home", "Maintenance", "Configuration", "System", "Logout", and "Help".

Channel: To change the channel, first toggle the *Auto Channel Selection* setting to **Disable**, and then use the drop-down menu to make the desired selection.

Note: *The wireless adapters will automatically scan and match the wireless settings.*

Channel Width: Allows you to select the channel width you would like to operate in. Select 20 MHz if you are not using any 802.11n wireless clients. Auto 20/40 MHz allows you to connect to both 802.11n and 802.11b/g or 802.11a wireless devices on your network.

Captive Profile: Enable or disable captive port profile for user authentication.

Authentication: Use the drop-down menu to choose **Open System, Shared Key, WPA-Personal, WPA-Enterprise, or 802.1x.**

- Select **Open System** to communicate the key across the network (WEP).
- Select **Shared Key** to limit communication to only those devices that share the same WEP settings. If multi-SSID is enabled, this option is not available.
- Select **WPA-Personal** to secure your network using a password and dynamic key changes. No RADIUS server is required.
- Select **WPA-Enterprise** to secure your network with the inclusion of a RADIUS server.
- Select **802.1X** if your network is using port-based Network Access Control.

WDS with AP Mode

Wireless Band: Select either 2.4GHz or 5GHz from the drop-down menu.

Mode: WDS with AP mode is selected from the drop-down menu.

Network Name (SSID): Service Set Identifier (SSID) is the name designated for a specific wireless local area network (WLAN). The SSID's factory default setting is dlink. The SSID can be easily changed to connect to an existing wireless network or to establish a new wireless network.

SSID Visibility: Enable or Disable SSID visibility. Enabling this feature broadcasts the SSID across the network, thus making it visible to all network users.

Auto Channel Selection: Enabling this feature automatically selects the channel that will provide the best wireless performance. This feature is not supported in WDS with AP mode. The channel selection process only occurs when the AP is booting up.

Channel: All devices on the network must share the same channel. To change the channel, use the drop-down menu to make the desired selection. (Note: The wireless adapters will automatically scan and match the wireless settings.)

Channel Width: Allows you to select the channel width you would like to operate in. Select 20 MHz if you are not using any 802.11n wireless clients. Auto 20/40 MHz allows you to connect to both 802.11n and 802.11b/g or 802.11a wireless devices on your network.

Wireless Settings

Wireless Band	2.4GHz ▾
Mode	WDS with AP ▾
Network Name (SSID)	dlink
SSID Visibility	Enable ▾
Auto Channel Selection	Disable ▾
Channel	1 ▾
Channel Width	20 MHz ▾
Captive Profile	Disable ▾

WDS

Remote AP MAC Address

1. <input style="width: 90%;" type="text"/>	2. <input style="width: 90%;" type="text"/>	3. <input style="width: 90%;" type="text"/>	4. <input style="width: 90%;" type="text"/>
5. <input style="width: 90%;" type="text"/>	6. <input style="width: 90%;" type="text"/>	7. <input style="width: 90%;" type="text"/>	8. <input style="width: 90%;" type="text"/>

Site Survey Scan

CH	RSSI	BSSID	Security	SSID

Authentication Open System ▾

Key Settings

Encryption Disable Enable

Key Type Key Size

HEX ▾ 64 Bits ▾

Key Index(1~4) Network Key

1 ▾

(0-9,a-z,A-Z,~!@#%&^&*()_+`-={}|:~\|,./<>?)

Save

Captive Profile: Enable or disable captive port profile for user authentication.

Remote AP MAC Address: Enter the MAC addresses of the APs on your network that will serve as bridges to wirelessly connect multiple networks.

Site Survey: Click on the **Scan** button to search for available wireless networks, then click on the available network that you want to connect with.

Authentication: Use the drop-down menu to choose **Open System**, **Shared Key**, or **WPA-Personal**.

- Select Open System to communicate the key across the network.
- Select Shared Key to limit communication to only those devices that share the same WEP settings. If multi-SSID is enabled, this option is not available.
- Select WPA-Personal to secure your network using a password and dynamic key changes. No RADIUS server is required.

WDS Mode

Wireless Band: Select either 2.4GHz or 5GHz from the drop-down menu.

Mode: WDS is selected from the drop-down menu.

Network Name (SSID): Service Set Identifier (SSID) is the name designated for a specific wireless local area network (WLAN). The SSID's factory default setting is **dlink**. The SSID can be easily changed to connect to an existing wireless network or to establish a new wireless network.

SSID Visibility: Enable or Disable SSID visibility. Enabling this feature broadcasts the SSID across the network, thus making it visible to all network users.

Auto Channel Selection: Enabling this feature automatically selects the channel that will provide the best wireless performance. This feature is not supported in WDS mode.

Channel: All devices on the network must share the same channel. To change the channel, use the drop-down menu to make the desired selection.

Channel Width: Use the drop-down menu to choose 20 MHz or Auto 20/40 MHz.

Captive Profile: Enable or disable captive port profile for user authentication.

Remote AP MAC Address: Enter the MAC addresses of the APs on your network that will serve as bridges to wirelessly connect multiple networks.

Wireless Settings

Wireless Band 2.4GHz ▾

Mode WDS ▾

Network Name (SSID) dlink

SSID Visibility Enable ▾

Auto Channel Selection Disable ▾

Channel 1 ▾

Channel Width 20 MHz ▾

Captive Profile Disable ▾

WDS

Remote AP MAC Address

1. 2. 3. 4.

5. 6. 7. 8.

Site Survey Scan

CH	RSSI	BSSID	Security	SSID

Authentication Open System ▾

Key Settings

Encryption Disable Enable

Key Type HEX ▾ Key Size 64 Bits ▾

Key Index(1~4) 1 ▾

Network Key

Confirm Key

(0-9,a-z,A-Z,~!@#\$\$%^&*()_+`-={}|:~\|,./<>?)

Save

Site Survey: Click on the **Scan** button to search for available wireless networks, then click on the available network that you want to connect with.

Authentication: Use the drop-down menu to choose **Open System**, **Shared Key**, or **WPA-Personal**.

- Select Open System to communicate the key across the network.
- Select Shared Key to limit communication to only those devices that share the same WEP settings.
- Select WPA-Personal to secure your network using a password and dynamic key changes. No RADIUS server is required.

Wireless Client Mode

Wireless Band: Select either 2.4 GHz or 5 GHz from the drop-down menu.

Mode: Wireless Client is selected from the drop-down menu.

Network Name (SSID): Service Set Identifier (SSID) is the name designated for a specific wireless local area network (WLAN). The SSID's factory default setting is dlink. The SSID can be easily changed to connect to an existing wireless network.

SSID Visibility: This option is unavailable in Wireless Client mode.

Auto Channel Selection: Enabling this feature automatically selects the channel that will provide the best wireless performance. This feature is not supported in Wireless Client mode.

Channel: The channel used will be displayed, and matches the AP that the DAP-2660 is connected to when set to Wireless Client mode.

Channel Width: Use the drop-down menu to choose 20 MHz or Auto 20/40 MHz.

Site Survey: Click on the **Scan** button to search for available wireless networks, then click on the available network that you want to connect with.

Captive Profile: Enable or disable captive port profile for user authentication.

Authentication: Will be explained in the next topic.

Wireless Settings

Wireless Band 2.4GHz ▾

Mode Wireless Client ▾

Network Name (SSID)

SSID Visibility Enable ▾

Auto Channel Selection Enable ▾

Channel 1 ▾

Channel Width Auto 20/40 MHz ▾

Captive Profile Disable ▾

Site Survey

CH	RSSI	BSSID	Security	SSID

Authentication Open System ▾

Key Settings

Encryption Disable Enable

Key Type Key Size 64 Bits ▾

Key Type HEX ▾

Key Index(1~4) 1 ▾

Network Key

Confirm Key

(0-9,a-z,A-Z,~!@#\$\$%^&*()_+`-={}|:~\./<>?)

Wireless MAC Clone

Enable

MAC Source Auto ▾

MAC Address : : : : :

MAC Address

Wireless Security

Wireless security is a key concern for any wireless network installed. Unlike any other networking method wireless networks will broadcast its presence for anyone to connect to it. Today, wireless security has advanced to a level where it is virtually impenetrable.

There are mainly two forms of wireless encryption and they are called Wired Equivalent Privacy (WEP) and Wi-Fi Protected Access (WPA). WEP was the first security method developed. It is a low level encryption but better than now encryption. WPA is the newest encryption standard and with the advanced WPA2 standard wireless networks have finally reach a point where the security is strong enough to give users the peace of mind when installing wireless networks.

Wired Equivalent Privacy (WEP)

WEP provides two variations called **Open System** and **Shared Key**.

Open System will send a request to the access point and if the key used matches the one configured on the access point, the access point will return a success message back to the wireless client. If the key does not match the one configured on the access point, the access point will deny the connection request from the wireless client.

Shared Key will send a request to the access point and if the key used matches the one configured on the access point, the access point will send a challenge to the client. The client will then again send a confirmation of the same key back to the access point where the access point will either return a successful or a denial packet back to the wireless client.

Encryption: Use the radio button to disable or enable encryption.

Key Type*: Select HEX or ASCII.

Key Size: Select 64 Bits or 128 Bits.

Key Index (1-4): Select the 1st through the 4th key to be the active key.

Key: Input up to four keys for encryption. You will select one of these keys in the Key Index drop-down menu.

**Hexadecimal (HEX) digits consist of the numbers 0-9 and the letters A-F.

*ASCII (American Standard Code for Information Interchange) is a code that represents English letters using numbers ranging from 0-127.

The screenshot displays the 'Wireless Settings' configuration interface. The 'Key Settings' section is expanded, showing the following options:

- Encryption: Enable
- Key Type: HEX
- Key Size: 64 Bits
- Key Index(1~4): 1
- Network Key: [Redacted]
- Confirm Key: [Redacted]

Below the key input fields, a validation string is shown: (0-9,a-z,A-Z,~!@#%&^&*()_+~={}|:~\|,./<>?)

Wi-Fi Protected Access (WPA / WPA2)

WPA was created by the Wi-Fi Alliance to address the limitations and weaknesses found in WEP. This protocol is mainly based on the 802.11i standard. There are also two variations found in WPA called WPA-Personal (PSK) and WPA-Enterprise (EAP).

WPA-EAP requires the user to install a Radius Server on the network for authentication.

WPA-Personal does not require the user to install a Radius Server on the network.

Comparing WPA-PSK with WPA-EAP, WPA-PSK is seen as a weaker authentication but comparing WPA-PSK to WEP, WPA-PSK is far more secure than WEP. WPA-EAP is the highest level of wireless security a user can use for wireless today.

WPA2 is an upgrade of WPA. WPA2 yet again solves some possible security issues found in WPA. WPA2 has two variations called WPA2-Personal (PSK) and WPA2-Enterprise (EAP) which is the same as found with WPA.

WPA Mode: When WPA-Personal is selected for Authentication type, you must also select a WPA mode from the drop-down menu: AUTO (WPA or WPA2), WPA2 Only, or WPA Only. WPA and WPA2 use different algorithms. AUTO (WPA or WPA2) allows you to use both WPA and WPA2.

Cipher Type: When you select WPA-Personal, you must also select AUTO, AES, or TKIP from the pull down menu.

Group Key Update: Select the interval during which the group key will be valid. The default value of 1800 is recommended.

Pass Phrase: When you select WPA-Personal, please enter a Pass Phrase in the corresponding field.

Wireless Settings

Wireless Band: 2.4GHz

Mode: Access Point

Network Name (SSID): dlink

SSID Visibility: Enable

Auto Channel Selection: Enable

Channel: 1

Channel Width: 20 MHz

Captive Profile: Disable

Authentication: WPA-Personal

PassPhrase Settings

WPA Mode: AUTO (WPA or WPA2)

Cipher Type: Auto Group Key Update Interval: 3600 (Seconds)

Manual Periodical Key Change

Activated From: Sun : 00 : 00

Time Interval: 1 (1~168)hour(s)

PassPhrase:

Confirm PassPhrase:

notice: 8~63 in ASCII or 64 in Hex
(0-9,a-z,A-Z,~!@#\$\$%^&*()_+`-={}|:~\|,./<>?)

Save

WPA Mode: When WPA-Enterprise is selected, you must also select a WPA mode from the drop-down menu: AUTO (WPA or WPA2), WPA2 Only, or WPA Only. WPA and WPA2 use different algorithms. AUTO (WPA or WPA2) allows you to use both WPA and WPA2.

Cipher Type: When WPA-Enterprise is selected, you must also select a cipher type from the drop-down menu: Auto, AES, or TKIP.

Group Key Update Interval: Select the interval during which the group key will be valid. 1800 is the recommended value as a lower interval may reduce data transfer rates.

Network Access Protection: Enable or disable Microsoft Network Access Protection.

RADIUS Server: Enter the IP address of the RADIUS server.

RADIUS Port: Enter the RADIUS port.

RADIUS Secret: Enter the RADIUS secret.

Account Server: Enter the IP address of the Account Server

Account Port: Enter the Account port

Account Secret: Enter the Account secret

Wireless Settings

Wireless Band	2.4GHz ▾	
Mode	Access Point ▾	
Network Name (SSID)	dlink	
SSID Visibility	Enable ▾	
Auto Channel Selection	Enable ▾	
Channel	1 ▾	
Channel Width	20 MHz ▾	
Captive Profile	Disable ▾	
Authentication	WPA-Enterprise ▾	

RADIUS Server Settings

WPA Mode	AUTO (WPA or WPA2) ▾	
Cipher Type	Auto ▾	Group Key Update Interval <input style="width: 50px;" type="text" value="3600"/> (Seconds)

Network Access Protection

Network Access Protection Disable Enable

RADIUS Server Mode

RADIUS Server External Internal

Primary RADIUS Server Setting

RADIUS Server	<input style="width: 150px;" type="text" value="192.168.0.100"/>	RADIUS Port	<input style="width: 50px;" type="text" value="1812"/>
RADIUS Secret	<input style="width: 150px;" type="password" value="*****"/>		

(0-9,a-z,A-Z,~!@#\$\$%^&*()_+`-={}|;'\":/,<>?)

Backup RADIUS Server Setting (Optional)

RADIUS Server	<input style="width: 150px;" type="text" value="192.168.0.101"/>	RADIUS Port	<input style="width: 50px;" type="text" value="1812"/>
RADIUS Secret	<input style="width: 150px;" type="password" value="*****"/>		

(0-9,a-z,A-Z,~!@#\$\$%^&*()_+`-={}|;'\":/,<>?)

Primary Accounting Server Setting

Accounting Mode	Enable ▾		
Accounting Server	<input style="width: 150px;" type="text" value="192.168.0.200"/>	Accounting Port	<input style="width: 50px;" type="text" value="1813"/>
Accounting Secret	<input style="width: 150px;" type="password" value="*****"/>		

(0-9,a-z,A-Z,~!@#\$\$%^&*()_+`-={}|;'\":/,<>?)

Backup Accounting Server Setting (Optional)

Accounting Server	<input style="width: 150px;" type="text" value="192.168.0.201"/>	Accounting Port	<input style="width: 50px;" type="text" value="1813"/>
Accounting Secret	<input style="width: 150px;" type="password" value="*****"/>		

(0-9,a-z,A-Z,~!@#\$\$%^&*()_+`-={}|;'\":/,<>?)

LAN

LAN is short for Local Area Network. This is considered your internal network. These are the IP settings of the LAN interface for the DAP-2660. These settings may be referred to as private settings. You may change the LAN IP address if needed. The LAN IP address is private to your internal network and cannot be seen on the Internet.

Get IP From: **Static IP (Manual)** is chosen here. Choose this option if you do not have a DHCP server in your network, or if you wish to assign a static IP address to the DAP-2660. When **Dynamic IP (DHCP)** is selected, the other fields here will be grayed out. Please allow about 2 minutes for the DHCP client to be functional once this selection is made.

IP Address: The default IP address is 192.168.0.50. Assign a static IP address that is within the IP address range of your network.

Subnet Mask: Enter the subnet mask. All devices in the network must share the same subnet mask.

Default Gateway: Enter the IP address of the gateway/router in your network.

DNS: Enter a DNS server IP address. This is usually the local IP address of your gateway/router.



The screenshot shows the 'LAN Settings' configuration window. It features a title bar with the text 'LAN Settings'. Below the title bar, there are five rows of configuration options, each with a label on the left and a corresponding input field on the right. The 'Get IP From' field is a dropdown menu currently set to 'Static IP (Manual)'. The 'IP Address' field contains the text '192.168.0.50'. The 'Subnet Mask' field contains '255.255.255.0'. The 'Default Gateway' and 'DNS' fields are currently empty. A 'Save' button is located in the bottom right corner of the window.

Field	Value
Get IP From	Static IP (Manual)
IP Address	192.168.0.50
Subnet Mask	255.255.255.0
Default Gateway	
DNS	

IPv6

Enable IPv6: Check to enable the IPv6

Get IP From: Auto is chosen here. Choose this option the DAP-2660 can get IPv6 address automatically or use Static to set IPv6 address manually. When Auto is selected, the other fields here will be grayed out.

IP Address: Enter the LAN IPv6 address used here.

Prefix: Enter the LAN subnet prefix length value used here.

Default Gateway: Enter the LAN default gateway IPv6 address used here.

The screenshot shows the 'IPv6 Settings' window. At the top, there is a title bar. Below it, the 'Enable IPv6' checkbox is checked. The 'Get IP From' dropdown menu is open, showing 'Auto' (selected), 'Static', and 'Auto'. Below the dropdown are input fields for 'IP Address', 'Prefix', and 'Default Gateway', all of which are grayed out. A 'Save' button is located in the bottom right corner.

Advanced Settings

In the Advanced Settings Section the user can configure advanced settings concerning Performance, Multiple SSID, VLAN, Security, Quality of Service, AP Array, Web Redirection, DHCP Server, Filters and Scheduling. The following pages will explain settings found in the Advanced Settings section in more detail.

The screenshot displays the D-Link DAP-2660 web management interface. The top navigation bar includes 'Home', 'Maintenance', 'Configuration', 'System', 'Logout', and 'Help'. A left sidebar shows a tree view of settings categories, with 'Advanced Settings' expanded to show 'Performance' selected. The main content area is titled 'Performance Settings' and contains the following configuration options:

Wireless band	2.4GHz
Wireless	On
Wireless Mode	Mixed 802.11n, 802.11g and 802.11b
Data Rate	Best(Up to 300) (Mbps)
Beacon Interval (40-500)	100
DTIM Interval (1-15)	1
Transmit Power	100%
WMM (Wi-Fi Multimedia)	Enable
Ack Time Out (2.4GHz, 48~200)	48 (μs)
Short GI	Enable
IGMP Snooping	Disable
Multicast Rate	Disable (Mbps)
Multicast Bandwidth Control	Disable
Maximum Multicast Bandwidth	100 kbps
HT20/40 Coexistence	Enable

A 'Save' button is located at the bottom right of the settings panel.

Performance

On the Performance Settings page the users can configure more advanced settings concerning the wireless signal and hosting.

Wireless Band: Select either 2.4GHz or 5GHz.

Wireless: Use the drop-down menu to turn the wireless function On or Off.

Wireless Mode: The different combination of clients that can be supported include Mixed 802.11n, 802.11g and 802.11b, Mixed 802.11g and 802.11b and 802.11n Only in the 2.4 GHz band and Mixed 802.11n, 802.11a, 802.11a only, and 802.11n Only in the 5 GHz band. Please note that when backwards compatibility is enabled for legacy (802.11a/g/b) clients, degradation of 802.11n (draft) wireless performance is expected.

Data Rate*: Indicate the base transfer rate of wireless adapters on the wireless LAN. The AP will adjust the base transfer rate depending on the base rate of the connected device. If there are obstacles or interference, the AP will step down the rate. This option is enabled in Mixed 802.11g and 802.11b mode (for 2.4 GHz) and 802.11a only mode (for 5 GHz). The choices available are Best (Up to 54), 54, 48, 36, 24, 18, 12, 9, 6 for 5 GHz and Best (Up to 54), 54, 48, 36, 24, 18, 12, 9, 6, 11, 5.5, 2 or 1 for 2.4 GHz.

Beacon Interval (25-500): Beacons are packets sent by an access point to synchronize a wireless network. Specify a value in milliseconds. The default (100) is recommended. Setting a higher beacon interval can help to save the power of wireless clients, while setting a lower one can help a wireless client connect to an access point faster.

DTM Interval (1-15): Select a Delivery Traffic Indication Message setting between 1 and 15. 1 is the default setting. DTIM is a countdown informing clients of the next window for listening to broadcast and multicast messages.

Performance Settings	
Wireless band	2.4GHz ▾
Wireless	On ▾
Wireless Mode	Mixed 802.11n, 802.11g and 802.11b ▾
Data Rate	Best(Up to 300) ▾ (Mbps)
Beacon Interval (40-500)	100
DTIM Interval (1-15)	1
Transmit Power	100% ▾
WMM (Wi-Fi Multimedia)	Enable ▾
Ack Time Out (2.4GHz, 48~200)	48 (μs)
Short GI	Enable ▾
IGMP Snooping	Disable ▾
Multicast Rate	Disable ▾ (Mbps)
Multicast Bandwidth Control	Disable ▾
Maximum Multicast Bandwidth	100 kbps
HT20/40 Coexistence	Enable ▾

Save

Transmit Power: This setting determines the power level of the wireless transmission. Transmitting power can be adjusted to eliminate overlapping of wireless area coverage between two access points where interference is a major concern. For example, if wireless coverage is intended for half of the area, then select 50% as the option. Use the drop-down menu to select 100%, 50%, 25%, or 12.5%.

WMM (Wi-Fi Multimedia): WMM stands for Wi-Fi Multimedia. Enabling this feature will improve the user experience for audio and video applications over a Wi-Fi network.

Ack Time Out (2.4 GHZ, 64~200): To effectively optimize throughput over long distance links enter a value for Acknowledgement Time Out between 25 and 200 microseconds for 5 GHz or from 64 to 200 microseconds in the 2.4 GHz in the field provided.

Short GI: Select Enable or Disable. Enabling a short guard interval can increase throughput. However, be aware that it can also increase the error rate in some installations due to increased sensitivity to radio-frequency installations.

IGMP Snooping: Select Enable or Disable. Internet Group Management Protocol allows the AP to recognize IGMP queries and reports sent between routers and an IGMP host (wireless STA). When IGMP snooping is enabled, the AP will forward multicast packets to an IGMP host based on IGMP messages passing through the AP.

Multicast Bandwidth Control: Adjust the multicast packet data rate here. The multicast rate is supported in AP mode, (2.4 GHZ and 5 GHZ) and WDS with AP mode, including Multi-SSIDs

HT20/40 Coexistence : Enable this option to reduce interference from other wireless networks in your area. If the channel width is operating at 40MHz and there is another wireless network's channel over-lapping and causing interference, the Access Point will automatically change to 20MHz

Wireless Resource Control

The Wireless Resource Control window is used to configure the wireless connection settings so that the device can detect the better wireless connection in your environment.

Wireless band: Select **2.4GHz** or **5GHz**.

Band Steering: Use the drop-down menu to **Enable** the 5G Preferred function. When the wireless clients support both 2.4GHz and 5GHz and the 2.4GHz signal is not strong enough, the device will use 5G as higher priority.

Band Steering Age: Enter the time in seconds to specify the interval of updating information.

Band Steering Difference: The 5G preferred difference value is equal to the number of 5GHz wireless client connections minus the number of 2.4GHz wireless client connections. If the number of 5GHz wireless client connections minus the number of 2.4GHz wireless client connections exceed this value, the extra 5GHz wireless client connections will be forced to connect to the 2.4GHz band and not the 5GHz band.

Band Steering Refuse Number: Enter the maximum 5G connection attempts allowed before the 5G preferred function will be disabled for the wireless station connection.

Connection Limit: Select **Enable** or **Disable**. This is an option for load balancing. This determines whether to limit the number of users accessing this device. The exact number is entered in the User Limit field below. This feature allows the user to share the wireless network traffic and the client using multiple APs. If this function is enabled and when the number of users exceeds this value, or the network utilization of this AP exceeds the percentage that has been specified, the DAP-2660 will not allow clients to associate with the AP.

User Limit: Set the maximum amount of users that are allowed access (zero to 64 users) to the device using the specified wireless band. The default setting is 20.

Wireless Resource Control	
Wireless band	2.4GHz ▾
Band Steering	Disable ▾
Band Steering Age	180 (s)
Band Steering Difference	2
Band Steering Refuse Number	3
Connection Limit	Disable ▾
User Limit (0 - 64)	20
11n Preferred	Disable ▾
Network Utilization	100% ▾
Aging out	Disable ▾
RSSI Threshold	100% ▾
Data Rate Threshold	54 ▾
ACL RSSI	Disable ▾
ACL RSSI Threshold	60% ▾

Save

11n Preferred: Use the drop-down menu to **Enable** the 11n Preferred function. The wireless clients with 802.11n protocol will have higher priority to connect to the device.

Network Utilization: Set the maximum utilization of this access point for service. The DAP-2660 will not allow any new clients to associate with the AP if the utilization exceeds the value the user specifies. Select a utilization percentage between 100%, 80%, 60%, 40%, 20%, or 0%. When this network utilization threshold is reached, the device will pause one minute to allow network congestion to dissipate.

Aging out: Use the drop-down menu to select the criteria of disconnecting the wireless clients. Available options are **RSSI** and **Data Rate**.

RSSI Threshold: When **RSSI** is selected in the **Aging out** drop-down menu, select the percentage of RSSI here. When the RSSI of wireless clients is lower than the specified percentage, the device disconnects the wireless clients.

Data Rate Threshold: When **Data Rate** is selected in the **Aging out** drop-down menu, select the threshold of data rate here. When the data rate of wireless clients is lower than the specified number, the device disconnects the wireless clients.

ACL RSSI: Use the drop-down menu to **Enable** the function. When enabled, the device denies the connection request from the wireless clients with the RSSI lower than the specified threshold below.

ACL RSSI Threshold: Set the ACL RSSI Threshold.

Multi-SSID

The device supports up to four multiple Service Set Identifiers. You can set the Primary SSID in the Basic > Wireless section. The SSID's factory default setting is dlink. The SSID can be easily changed to connect to an existing wireless network or to establish a new wireless network.

Enable Multi-SSID: Check to enable support for multiple SSIDs.

Band: Select **2.4GHz** or **5GHz**.

Index: You can select up to three multi-SSIDs. With the Primary SSID, you have a total of four multi-SSIDs.

SSID: Service Set Identifier (SSID) is the name designated for a specific wireless local area network (WLAN). The SSID's factory default setting is **dlink**. The SSID can be easily changed to connect to an existing wireless network or to establish a new wireless network.

SSID Visibility: Enable or Disable SSID visibility. Enabling this feature broadcasts the SSID across the network, thus making it visible to all network users.

Security: The Multi-SSID security can be Open System, WPA-Personal, or WPA-Enterprise. For a detailed description of the Open System parameters please go to page 23. For a detailed description of the WPA-Personal parameters please go to page 24. For a detailed description of the WPA-Enterprise parameters please go to page 25.

Priority: Select the priority level of the SSID selected.

WMM (Wi-Fi Multimedia): WMM stands for Wi-Fi Multimedia. Enabling this feature will improve the user experience for audio and video applications over a Wi-Fi network.

Captive Profile: Enable or disable captive port profile for user authentication.

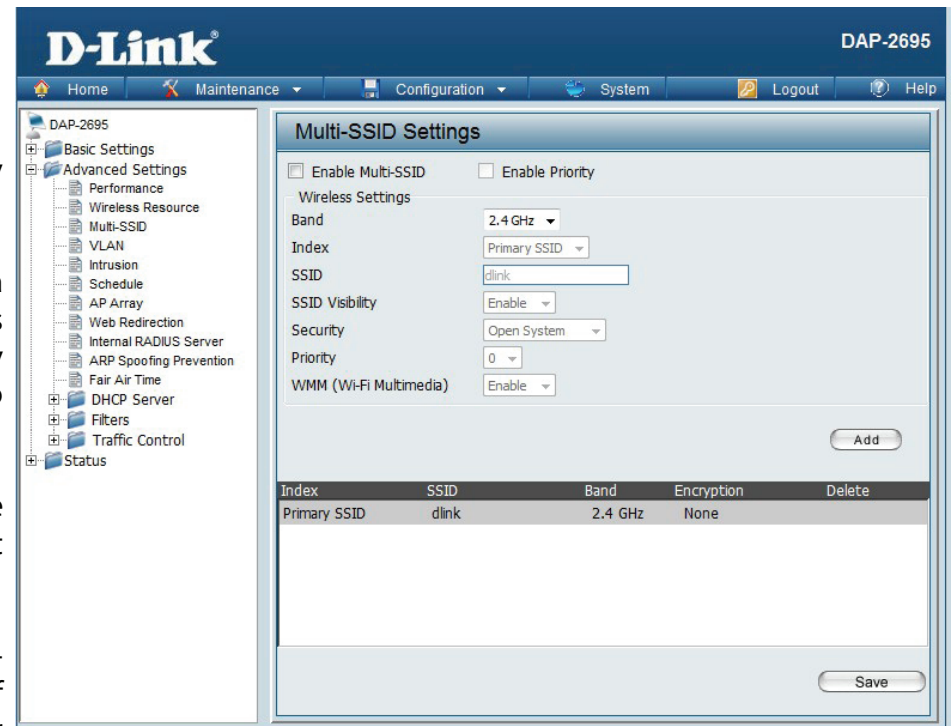

Encryption: When you select Open System, toggle between Enable and Disable. If Enable is selected, the Key Type, Key Size, Key Index (1~4), Key, and Confirm Keys must also be configured.

Key Type: Select HEX or ASCII.

Key Size: Select 64-bit or 128-bit.

Key Index (1-4): Select from the 1st to 4th key to be set as the active key.

Key: Input up to four keys for encryption. You will select one of these keys in the Key Index drop-down menu.

WPA Mode: When you select either WPA-Personal or WPA-Enterprise, you must also choose a WPA mode from the drop-down menu: AUTO (WPA or WPA2), WPA2 Only, or WPA Only. WPA and WPA2 use different algorithms. AUTO (WPA or WPA2) allows you to use both WPA and WPA2. In addition, you must configure Cipher Type, and Group Key Update Interval.

Cipher Type: Select Auto, AES, or TKIP from the drop-down menu.

Group Key Update Interval: Select the interval during which the group key will be valid. The default value of 1800 seconds is recommended.

Pass Phrase: When you select WPA-Personal, please enter a Pass Phrase in the corresponding field.

Confirm Pass Phrase: When you select WPA-Personal, please re-enter the Pass Phrase entered in the previous item in the corresponding field.

RADIUS Server: When you select WPA-Enterprise, enter the IP address of the RADIUS server. In addition, you must configure RADIUS Port and RADIUS Secret.

RADIUS Port: Enter the RADIUS port.

RADIUS Secret: Enter the RADIUS secret.

VLAN

VLAN List

The DAP-2660 supports VLANs. VLANs can be created with a Name and VID. Mgmt (TCP stack), LAN, Primary/Multiple SSID, and WDS connection can be assigned to VLANs as they are physical ports. Any packet which enters the DAP-2660 without a VLAN tag will have a VLAN tag inserted with a PVID. The VLAN List tab displays the current VLANs.

VLAN Status: Use the radio button to toggle to Enable. Next, go to the Add/Edit VLAN tab to add or modify an item on the VLAN List tab.

VLAN Mode: The current VLAN mode is displayed.

VLAN Settings

VLAN Status : Disable Enable Save

VLAN Mode : Static(2.4G), Static(5G)

VLAN List				
VID	VLAN Name	Untag VLAN Ports	Tag VLAN Ports	Edit Delete
1	default	Mgmt, LAN, Primary(2.4G), S-1(2.4G), S-2(2.4G), S-3(2.4G), S-4(2.4G), S-5(2.4G), S-6(2.4G), S-7(2.4G), W-1(2.4G), W-2(2.4G), W-3(2.4G), W-4(2.4G), W-5(2.4G), W-6(2.4G), W-7(2.4G), W-8(2.4G), Primary(5G), S-1(5G), S-2(5G), S-3(5G), S-4(5G), S-5(5G), S-6(5G), S-7(5G), W-1(5G), W-2(5G), W-3(5G), W-4(5G), W-5(5G), W-6(5G), W-7(5G), W-8(5G)		

Port List

The Port List tab displays the current ports. If you want to configure the guest and internal networks on a Virtual LAN (VLAN), the switch and DHCP server you are using must also support VLANs. As a prerequisite step, configure a port on the switch for handling VLAN tagged packets as described in the IEEE 802.1Q standard.

VLAN Status: Use the radio button to toggle to Enable. Next, go to the Add/Edit VLAN tab to add or modify an item on the VLAN List tab.

Port Name: The name of the port is displayed in this column.

Tag VID: The Tagged VID is displayed in this column.

Untag VID: The Untagged VID is displayed in this column.

PVID: The Port VLAN Identifier is displayed in this column.

VLAN Settings			
VLAN Status : <input type="radio"/> Disable <input checked="" type="radio"/> Enable <input type="button" value="Save"/>			
VLAN Mode : Static(2.4G), Static(5G)			
<input type="button" value="VLAN List"/>	<input checked="" type="button" value="Port List"/>	<input type="button" value="Add/Edit VLAN"/>	<input type="button" value="PVID Setting"/>
Port Name	Tag VID	Untag VID	PVID
Mgmt		1	1
LAN		1	1
Primary(2.4G)		1	1
Primary(5G)		1	1
S-1(2.4G)		1	1
S-2(2.4G)		1	1
S-3(2.4G)		1	1
S-4(2.4G)		1	1
S-5(2.4G)		1	1
S-6(2.4G)		1	1
S-7(2.4G)		1	1
W-1(2.4G)		1	1
W-2(2.4G)		1	1
W-3(2.4G)		1	1
W-4(2.4G)		1	1
W-5(2.4G)		1	1
W-6(2.4G)		1	1
W-7(2.4G)		1	1
W-8(2.4G)		1	1
S-1(5G)		1	1
S-2(5G)		1	1
S-3(5G)		1	1
S-4(5G)		1	1
S-5(5G)		1	1
S-6(5G)		1	1
S-7(5G)		1	1
W-1(5G)		1	1
W-2(5G)		1	1
W-3(5G)		1	1
W-4(5G)		1	1
W-5(5G)		1	1
W-6(5G)		1	1
W-7(5G)		1	1
W-8(5G)		1	1

Add/Edit VLAN

The Add/Edit VLAN tab is used to configure VLANs. Once you have made the desired changes, click the Save button to let your changes take effect.

VLAN Status: Use the radio button to toggle to Enable.

VLAN ID: Provide a number between 1 and 4094 for the Internal VLAN.

VLAN Name: Enter the VLAN to add or modify.

VLAN Settings

VLAN Status : Disable Enable Save

VLAN Mode : Static(2.4G), Static(5G)

VLAN List | Port List | **Add/Edit VLAN** | PVID Setting

VLAN ID (VID) VLAN Name

Port	Select All	Mgmt	LAN
Untag	All	<input type="radio"/>	<input type="radio"/>
Tag	All	<input type="radio"/>	<input type="radio"/>
Not Member	All	<input type="radio"/>	<input type="radio"/>

2.4GHz

MSSID Port	Select All	Primary	S-1	S-2	S-3	S-4	S-5	S-6	S-7
Untag	All	<input type="radio"/>	<input type="radio"/>	<input type="radio"/>	<input type="radio"/>	<input type="radio"/>	<input type="radio"/>	<input type="radio"/>	<input type="radio"/>
Tag	All	<input type="radio"/>	<input type="radio"/>	<input type="radio"/>	<input type="radio"/>	<input type="radio"/>	<input type="radio"/>	<input type="radio"/>	<input type="radio"/>
Not Member	All	<input type="radio"/>	<input type="radio"/>	<input type="radio"/>	<input type="radio"/>	<input type="radio"/>	<input type="radio"/>	<input type="radio"/>	<input type="radio"/>

WDS Port	Select All	W-1	W-2	W-3	W-4	W-5	W-6	W-7	W-8
Untag	All	<input type="radio"/>	<input type="radio"/>	<input type="radio"/>	<input type="radio"/>	<input type="radio"/>	<input type="radio"/>	<input type="radio"/>	<input type="radio"/>
Tag	All	<input type="radio"/>	<input type="radio"/>	<input type="radio"/>	<input type="radio"/>	<input type="radio"/>	<input type="radio"/>	<input type="radio"/>	<input type="radio"/>
Not Member	All	<input type="radio"/>	<input type="radio"/>	<input type="radio"/>	<input type="radio"/>	<input type="radio"/>	<input type="radio"/>	<input type="radio"/>	<input type="radio"/>

5GHz

MSSID Port	Select All	Primary	S-1	S-2	S-3	S-4	S-5	S-6	S-7
Untag	All	<input type="radio"/>	<input type="radio"/>	<input type="radio"/>	<input type="radio"/>	<input type="radio"/>	<input type="radio"/>	<input type="radio"/>	<input type="radio"/>
Tag	All	<input type="radio"/>	<input type="radio"/>	<input type="radio"/>	<input type="radio"/>	<input type="radio"/>	<input type="radio"/>	<input type="radio"/>	<input type="radio"/>
Not Member	All	<input type="radio"/>	<input type="radio"/>	<input type="radio"/>	<input type="radio"/>	<input type="radio"/>	<input type="radio"/>	<input type="radio"/>	<input type="radio"/>

WDS Port	Select All	W-1	W-2	W-3	W-4	W-5	W-6	W-7	W-8
Untag	All	<input type="radio"/>	<input type="radio"/>	<input type="radio"/>	<input type="radio"/>	<input type="radio"/>	<input type="radio"/>	<input type="radio"/>	<input type="radio"/>
Tag	All	<input type="radio"/>	<input type="radio"/>	<input type="radio"/>	<input type="radio"/>	<input type="radio"/>	<input type="radio"/>	<input type="radio"/>	<input type="radio"/>
Not Member	All	<input type="radio"/>	<input type="radio"/>	<input type="radio"/>	<input type="radio"/>	<input type="radio"/>	<input type="radio"/>	<input type="radio"/>	<input type="radio"/>

Save

PVID Settings

The PVID Setting tab is used to enable/disable the Port VLAN Identifier Auto Assign Status as well as to configure various types of PVID settings. Click the Save button to let your changes take effect.

VLAN Status: Use the radio button to toggle between Enable and Disable.

PVID Auto Assign Status: Use the radio button to toggle PVID auto assign status to Enable.

VLAN Settings

VLAN Status : Disable Enable Save

VLAN Mode : Static(2.4G), Static(5G)

VLAN List
Port List
Add/Edit VLAN
PVID Setting

PVID Auto Assign Status Disable Enable

Port	Mgmt	LAN
PVID	1	1

2.4GHz

MSSID Port	Primary	S-1	S-2	S-3	S-4	S-5	S-6	S-7
PVID	1	1	1	1	1	1	1	1
WDS Port	W-1	W-2	W-3	W-4	W-5	W-6	W-7	W-8
PVID	1	1	1	1	1	1	1	1

5GHz

MSSID Port	Primary	S-1	S-2	S-3	S-4	S-5	S-6	S-7
PVID	1	1	1	1	1	1	1	1
WDS Port	W-1	W-2	W-3	W-4	W-5	W-6	W-7	W-8
PVID	1	1	1	1	1	1	1	1

Save

Intrusion

The Wireless Intrusion Protection window is used to set APs as All, Valid, Neighborhood, Rogue, and New. Click the Save button to let your changes take effect.

Wireless Band: Select 2.4GHz or 5GHz.

AP List: The choices include All, Valid, Neighbor, Rogue, and New.

Detect: Click this button to initiate a scan of the network.

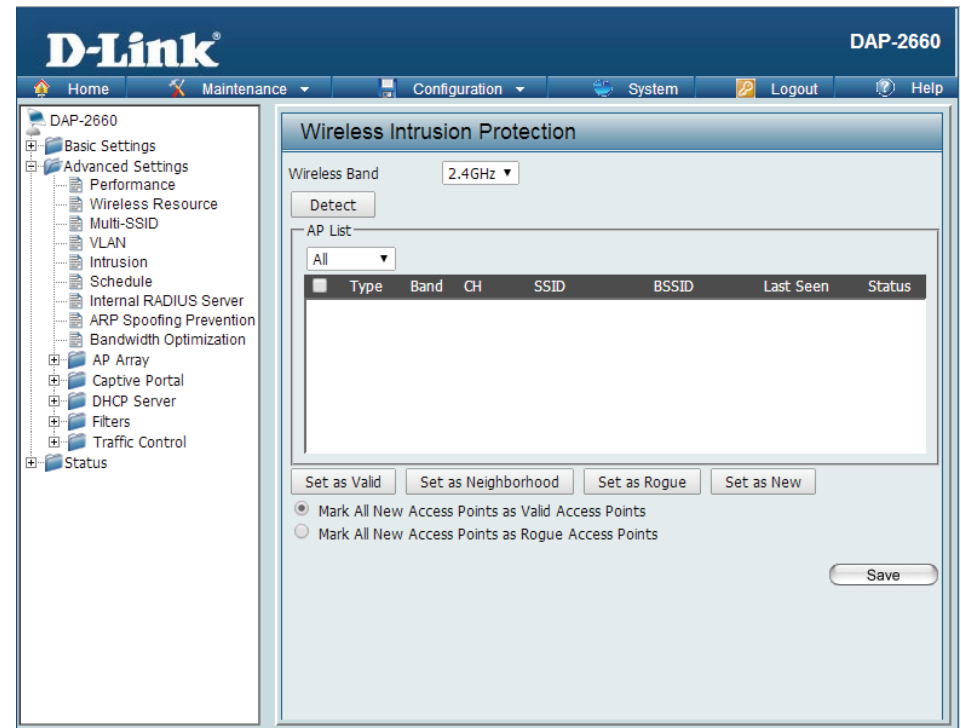

Schedule

The Wireless Schedule Settings window is used to add and modify scheduling rules on the device. Click the Save button to let your changes take effect.

Wireless Schedule: Use the drop-down menu to enable the device's scheduling feature.

Name: Enter a name for the new scheduling rule in the field provided.

Index: Use the drop-down menu to select the desired SSID.

SSID: This read-only field indicates the current SSID in use. To create a new SSID, go to the Wireless Settings window (Basic Settings > Wireless).

Day(s): Toggle the radio button between All Week and Select Day(s). If the second option is selected, check the specific days you want the rule to be effective on.

All Day(s): Check this box to have your settings apply 24 hours a day.

Start Time: Enter the beginning hour and minute, using a 24-hour clock.

End Time: Enter the ending hour and minute, using a 24-hour clock.

Wireless Schedule Settings

Wireless Schedule:

Add Schedule Rule

Name:

Index:

SSID:

Day(s): All Week Select Day(s)

Sun Mon Tue Wed Thu Fri Sat

All Day(s):

Start Time: : (hour:minute, 24 hour time)

End Time: : (hour:minute, 24 hour time) Overnight

Schedule Rule List

Name	SSID Index	SSID	Day(s)	Time Frame	Wireless Edit	DEL
+: To the end time of the next day overnight.						

Internal RADIUS Server

The DAP-2660 features a built-in RADIUS server. Once you have finished adding a RADIUS account, click the Save button to let your changes take effect. The newly-created account will appear in this RADIUS Account List. The radio buttons allow the user to enable or disable the RADIUS account. Click the icon in the delete column to remove the RADIUS account. We suggest you limit the number of accounts below 30.

User Name: Enter a name to authenticate user access to the internal RADIUS server.

Password: Enter a password to authenticate user access to the internal RADIUS server. The length of your password should be 8~64.

Status: Toggle the drop-down menu between Enable and Disable.

RADIUS Account List: Displays the list of users.

The screenshot displays the D-Link DAP-2660 web interface. The top navigation bar includes 'Home', 'Maintenance', 'Configuration', 'System', 'Logout', and 'Help'. The left sidebar shows a tree view of configuration options, with 'Internal RADIUS Server' selected. The main content area is titled 'Internal RADIUS Server' and contains two sections: 'Add RADIUS Account' and 'RADIUS Account list'. The 'Add RADIUS Account' section has input fields for 'User Name' and 'Password', and a 'Status' dropdown menu set to 'Enable'. The 'RADIUS Account list' section is currently empty, with a 'Save' button at the bottom right.

ARP Spoofing Prevention

The ARP Spoofing Prevention feature allows users to add IP/MAC address mapping to prevent arp spoofing attack.

ARP Spoofing Prevention: This check box allows you to enable the arp spoofing prevention function.

Gateway IP Address: Enter a gateway IP address.

Gateway MAC Address: Enter a gateway MAC address.

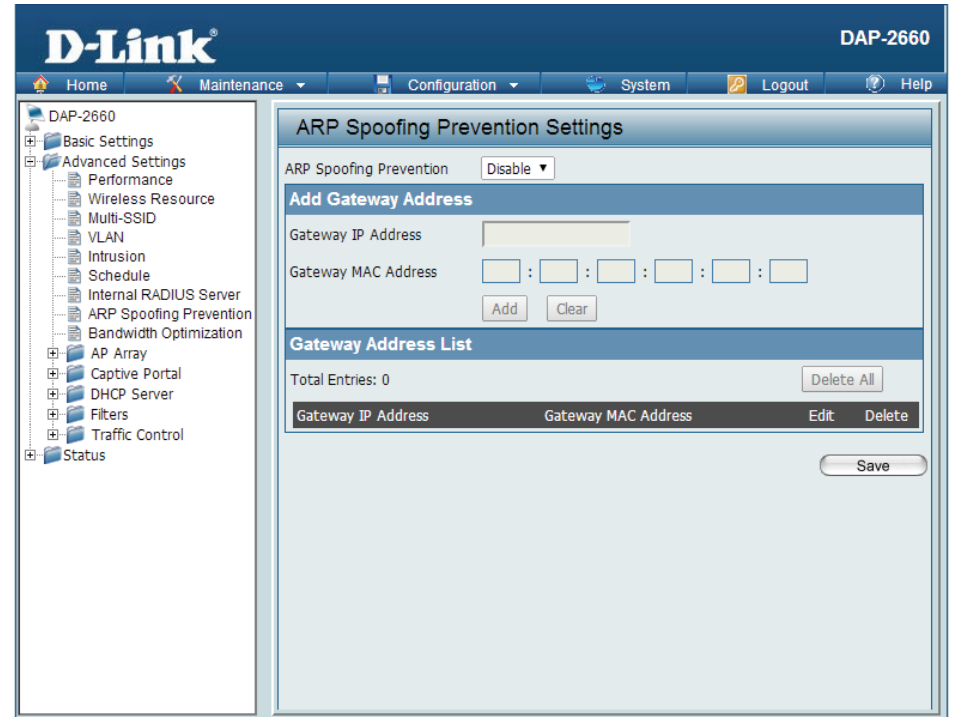

Bandwidth Optimization

The Bandwidth Optimization window allows the user to manage the bandwidth of the device and arrange the bandwidth for various wireless clients. When the Bandwidth Optimization rule is finished, click the **Add** button. To discard the Add Bandwidth Optimization Rule settings, click the **Clear** button. Click the **Save** button to let your changes take effect.

Enable Bandwidth Optimization: Use the drop-down menu to Enable the Bandwidth Optimization function.

Downlink Bandwidth: Enter the downlink bandwidth of the device in Mbits per second.

Uplink Bandwidth: Enter the uplink bandwidth of the device in Mbits per second.

Allocate average BW for each station: AP will distribute average bandwidth for each client.

Allocate maximum BW for each station: Specify the maximum bandwidth for each connected client. Reserve certain bandwidth for future clients.

Allocate different BW for a/b/g/n stations: The weight of 11b/g/n and 11a/n client are 10%/20%/70% ; 20%/80%. AP will distribute different bandwidth for 11a/b/g/n clients.

Allocate specific BW for SSID: All clients share the total bandwidth.

Rule Type: Use the drop-down menu to select the type that is applied to the rule. Available options are: **Allocate average BW for each station**, **Allocate maximum BW for each station**, **Allocate different BW for 1a/b/g/n stations**, and **Allocate specific BW for SSID**.

Bandwidth Optimization

Enable Bandwidth Optimization Enable

Downlink Bandwidth Mbits/sec

Uplink Bandwidth Mbits/sec

Add Bandwidth Optimization Rule

Rule Type Allocate average BW for each station

Band 2.4 GHz

SSID Index Primary SSID

Downlink Speed Kbits/sec

Uplink Speed Kbits/sec

Bandwidth Optimization Rules

Band	Type	SSID Index	Downlink Speed	Uplink Speed	Edit	Del

Band: Use the drop-down menu to toggle the wireless band between 2.4GHz and 5GHz.

SSID Index: Use the drop-down menu to select the SSID for the specified wireless band.

Downlink Speed: Enter the limitation of the downloading speed in either Kbits/sec or Mbits/sec for the rule.

Uplink Speed: Enter the limitation of the uploading speed in either Kbits/sec or Mbits/sec for the rule.

AP Array

AP Array Scan

The AP Array window is used to create up to 32 APs on a local network to be organized into a single group in order to increase ease of management. Click the **Save** button to let your changes take effect. Central WiFiManager and AP Array are mutually exclusive functions.

Enable AP Array: Select the check box to enable the AP array function. The three modes that are available are **Master**, **Backup Master**, and **Slave**. APs in the same array will use the same configuration. The configuration will sync the Master AP to the Slave AP and the Backup Master AP when a Slave AP and a Backup Master AP join the AP array.

AP Array Name: Enter an AP array name for the group here.

AP Array Password: Enter an AP array password for the group here. This password must be the same on all the APs in the group.

Scan AP Array List: Click this button to initiate a scan of all the available APs currently on the network.

Connection Status: Display the AP array connection status.

AP Array List: This table displays the current AP array status for the following parameters: Array Name, Master IP, MAC, Master, Backup Master, Slave, and Total.

Current Members: This table displays all the current array members. The DAP-2660 AP array feature supports up to eight AP array members.

The screenshot shows the D-Link DAP-2660 web interface. The main content area is titled "AP Array Scan" and includes the following elements:

- Enable AP Array (Version: 2.0)
- Mode selection: Master, Backup Master, Slave
- AP Array Name:
- AP Array Password:
- Scan AP Array List:
- Connection Status: Disconnect
- AP Array List table:

Array Name	Master IP	MAC	Master	Backup Master	Slave	Total

Current Members table:

Index	Role	IP Address	MAC Address	Location

At the bottom right of the configuration area is a button.

Configuration Settings

In the AP array configuration settings windows, users can specify which settings all the APs in the group will inherit from the master AP. Make the required selection in this window and click the **Save** button to accept the changes made.

- Enable AP Array Configuration:** Select to **Enable** or **Disable** the AP array configuration feature here.
- Wireless Basic Settings:** Select this option to specify the basic wireless settings that the APs in the group will inherit.
- Wireless Advanced Settings:** Select this option to specify the advanced wireless settings that the APs in the group will inherit.
- Multiple SSID & VLAN:** Select this option to specify the multiple SSIDs and VLAN settings that the APs in the group will inherit.
- Advanced Functions:** Select this option to specify the other advanced settings that the APs in the group will inherit.
- Administration Settings:** Select this option to specify the administrative settings that the APs in the group will inherit.

The screenshot shows the 'AP Array Configuration' window. At the top, there is a section for 'Enable AP Array Configuration' with a dropdown menu set to 'Enable' and a 'Clear all' button. Below this are five expandable sections, each with a checkbox: 'Wireless Basic Settings', 'Wireless Advanced Settings', 'Multiple SSID & VLAN', 'Advanced Functions', and 'Administration Settings'. A 'Save' button is located at the bottom right of the window.

Wireless Basic Settings

Network Name (SSID): Select this option to use the same SSID.

SSID Visibility: Select this option to enable SSID visibility.

Auto Channel Selection: Select this option to use auto channel selection.

Channel Width: Select this option to use the same channel width.

Security: Select this option to use the same wireless security.

Captive Profile: Select this option to use the same captive profile settings.

Band: Select this option to use the same wireless band.

Wireless Basic Settings <input checked="" type="checkbox"/>			
Network Name (SSID)	<input checked="" type="checkbox"/>	SSID Visibility	<input checked="" type="checkbox"/>
Auto Channel Selection	<input checked="" type="checkbox"/>	Channel Width	<input checked="" type="checkbox"/>
Security	<input checked="" type="checkbox"/>	Captive Profile	<input checked="" type="checkbox"/>
Band	<input checked="" type="checkbox"/>		

Wireless Advanced Settings

Wireless: Select this option to use the same wireless settings.

Wireless Mode: Select this option to use the same wireless mode.

Data Rate: Select this option to use the same data rate.

Beacon Interval: Select this option to use the same beacon interval.

DTIM Interval: Select this option to use the same DTIM interval.

Transmit Power: Select this option to use the same transmit power.

WMM (Wi-Fi Multimedia): Select this option to use the same WMM settings.

Ack Time Out: Select this option to use the same ACK timeout value.

Wireless ACL: Select this option to use the same wireless ACL settings.

Wireless Advanced Settings <input checked="" type="checkbox"/>			
Wireless	<input checked="" type="checkbox"/>	Wireless Mode	<input checked="" type="checkbox"/>
Data Rate	<input checked="" type="checkbox"/>	Beacon Interval	<input checked="" type="checkbox"/>
DTIM Interval	<input checked="" type="checkbox"/>	Transmit Power	<input checked="" type="checkbox"/>
WMM (Wi-Fi Multimedia)	<input checked="" type="checkbox"/>	Ack Time Out	<input checked="" type="checkbox"/>
Wireless ACL	<input checked="" type="checkbox"/>	Short GI	<input checked="" type="checkbox"/>
Link Integrity	<input checked="" type="checkbox"/>	Connection Limit	<input checked="" type="checkbox"/>
IGMP Snooping	<input checked="" type="checkbox"/>		

Short GI: Select this option to use the same short GI settings.

Link Integrity: Select this option to use the same link integrity settings.

Connection Limit: Select this option to use the same connection limit value.

IGMP Snooping: Select this option to use the same IGMP snooping settings.

Multiple SSID & VLAN

SSID: Select this option to use the same multi-SSIDs.

SSID Visibility: Select this option to use the same SSID visible.

Security: Select this option to use the same wireless security settings.

WMM: Select this option to use the same WMM settings.

Captive Profile: Select this option to use the same captive profile settings.

VLAN: Select this option to use the same VLAN settings.

Multiple SSID & VLAN <input checked="" type="checkbox"/>			
SSID	<input checked="" type="checkbox"/>	SSID Visibility	<input checked="" type="checkbox"/>
Security	<input checked="" type="checkbox"/>	WMM	<input checked="" type="checkbox"/>
Captive Profile	<input checked="" type="checkbox"/>	VLAN	<input checked="" type="checkbox"/>

Advanced Functions

Schedule Settings: Select this option to use the same schedule settings.

QoS Settings: Select this option to use the same Quality of Service settings.

Log Settings: Select this option to use the same log settings.

Time and Date Settings: Select this option to use the same time and date settings.

Advanced Functions <input checked="" type="checkbox"/>			
Schedule Settings	<input checked="" type="checkbox"/>	QoS Settings	<input checked="" type="checkbox"/>
Log Settings	<input checked="" type="checkbox"/>	Time and Date Settings	<input checked="" type="checkbox"/>
ARP Spoofing Prevention	<input checked="" type="checkbox"/>	Bandwidth Optimization	<input checked="" type="checkbox"/>
Captive Portal	<input checked="" type="checkbox"/>	Auto RF	<input checked="" type="checkbox"/>
Load Balance	<input checked="" type="checkbox"/>	DHCP server Settings	<input checked="" type="checkbox"/>

ARP Spoofing Prevention: Select this option to use the same ARP spoofing prevention settings.

Bandwidth Optimization: Select this option to use the same bandwidth optimization settings.

Captive Portal: Select this option to use the same captive portal settings.

Auto RF: Select this option to use the same auto-RF settings.

Load Balance: Select this option to use the same load balancing settings.

DHCP Server Settings: Select this option to use the same DHCP server settings.

Administration Settings

System Name Settings: Select this option to use the same system name.

SNMP Settings: Select this option to use the same SNMP settings.

Login Settings: Select this option to use the same login settings.

Console Settings: Select this option to use the same console settings.

Limit Administrator: Select this option to use the same limit administrator settings.

Ping Control Setting: Select this option to use the same ping control settings.

Administration Settings <input checked="" type="checkbox"/>	
System Name Settings <input checked="" type="checkbox"/>	SNMP Settings <input checked="" type="checkbox"/>
Login Settings <input checked="" type="checkbox"/>	Console Settings <input checked="" type="checkbox"/>
Limit Administrator <input checked="" type="checkbox"/>	Ping Control Setting <input checked="" type="checkbox"/>

Auto-RF

In this windows, users can view and configure the automatic radio frequency settings as well as configure the the auto-initiate period and threshold values. Click the **Save** button to accept the changes made.

Enable: Auto-RF: Select to **Enable** or **Disable** the auto-RF feature here.

Initiate Auto-RF: Click the **Auto-RF Optimize** button to initiate the auto-RF optimization feature.

Auto-Initiate: Select the **Enable** or **Disable** the auto-initiate feature here.

Auto-Initiate Period: After enabling the auto-initiate option, the auto-initiate period value can be entered here. This value must be between 1 and 24 hours.

RSSI Threshold: Select the RSSI threshold value here. This value is listed in the drop-down menu in increments of 10% from **10%** to **100%**.

RF Report Frequency: Enter the RF report frequency value here.

The screenshot shows the 'Auto-RF' configuration window with the following settings:

Setting	Value
Enable Auto-RF	Disable
Initiate Auto-RF	Auto-RF Optimize
Auto-Initiate	Disable
Auto-Initiate Period	24 (hours)
RSSI Threshold	40%
RF Report Frequency	10 (Seconds)

A 'Save' button is located at the bottom right of the window.

Load Balance

In this window, users can view and configure the AP array's load balancing settings. Click the Save button to accept the changes made.

Enable Load Balance: Select to **Enable** or **Disable** the load balance feature here.

Active Threshold: Enter the active threshold value here.

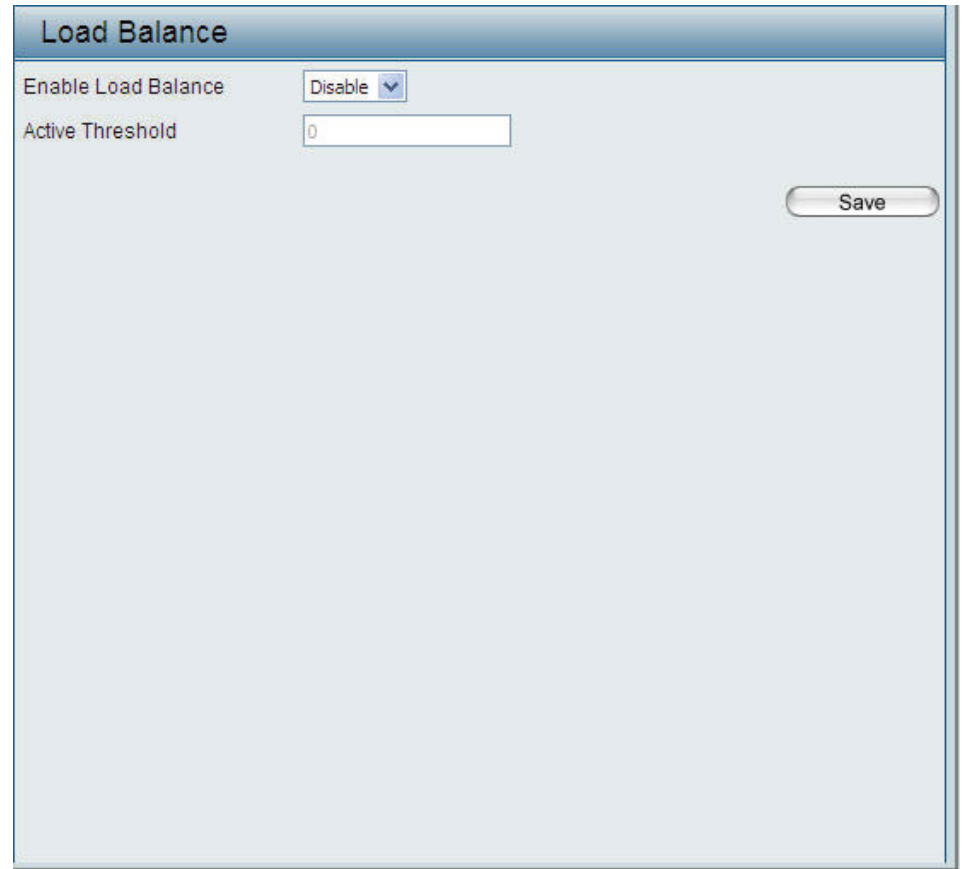

The screenshot shows a web-based configuration window titled "Load Balance". It contains two main settings:

- Enable Load Balance:** A dropdown menu currently set to "Disable".
- Active Threshold:** A text input field containing the value "0".

A "Save" button is located in the bottom right corner of the window.

Captive Portal

Authentication Settings - Ticket

The Captive Portal is a built-in web authentication server. When a station connects to an AP, the web browser will be redirected to a web authentication page. In this windows, user can view and configure the Captive Portal settings. Click the **Add** button to add a new entry. Click the **Delete** or **Delete All** button to remove a specific entry or all the entries configured.

Encryption Type: Select the captive portal encryption type here. Options to choose from are **Ticket, User/Password, Remote Radius, LDAP** and **POP3**. In this section we'll discuss the **Ticket** option.

Ticket Quantity: Enter the number of ticket that will be used here.

Duration: Enter the duration value, in hours, for this ticket.

Last Active Day: Select the last active date for this ticket here. **Year, Month** and **Day** selections can be made.

User Limit: Enter the maximum amount of users that can use this ticket at the same time.

Captive Portal Authentication

Encryption Type Ticket

Ticket Settings

Ticket Quantity

Duration Hours

Last Active Day Year Month Day

User Limit

Ticket	Duration	Last Active Day	User Limit	Delete

Captive Profile	Edit	Delete

Authentication Settings - User/Password

Encryption Type: Select the captive portal encryption type here. Options to choose from are **Ticket**, **User/Password**, **Remote Radius**, **LDAP** and **POP3**. In this section we'll discuss the **User/Password** option.

Restricted Subnets: Enter the restricted subnets here. Access to these subnets will be denied to guest accounts. Up to four restricted subnet entries can be defined.

Username: Enter the username for the new account here.

Password: Enter the password for the new account here.

Group: Select the group for the new account here. Options to choose from are **Manager** and **Guest**. Guest accounts will have limited access.

Captive Portal Authentication

Encryption Type Username/Password ▾

[Username/Password Settings](#)

IP Filter Settings

Restricted Subnets (example:192.168.0.0/16)

1. 2. 3. 4.

Username/Password Rule Settings

Username

Password

Group Manager ▾

Username	Group	Edit	Delete

Captive Profile	Edit	Delete

Authentication Settings - Remote RADIUS

Encryption Type: Select the captive portal encryption type here. Options to choose from are **Ticket**, **User/Password**, **Remote Radius**, **LDAP** and **POP3**. In this section we'll discuss the **Remote Radius** option.

Remote Radius Type: Select the remote RADIUS server type here. Currently, only **SPAP** will be used.

Radius Server: Enter the RADIUS server's IP address here.

Radius Port: Enter the RADIUS server's port number here.

Radius Secret: Enter the RADIUS server's shared secret here.

Accounting Mode: Select to **Enable** or **Disable** the accounting mode here.

Accounting Server: Enter the accounting server's IP address here.

Accounting Port: Enter the accounting server's port number here.

Accounting Secret: Enter the accounting server's shared secret here.

Captive Portal Authentication

Encryption Type: Remote RADIUS

Remote RADIUS Settings

Remote RADIUS Type: SPAP

Radius Server Settings

Radius Server: Radius Port: 1812

Radius Secret:

Accounting Server Settings

Accounting Mode: Disable

Accounting Server: Accounting Port: 1813

Accounting Secret:

Add

Captive Profile	Edit	Delete

Authentication Settings - LDAP

Encryption Type: Select the captive portal encryption type here. Options to choose from are **Ticket**, **User/Password**, **Remote Radius**, **LDAP** and **POP3**. In this section we'll discuss the **LDAP** option.

Server: Enter the LDAP server's IP address or domain name here.

Port: Enter the LDAP server's port number here.

Authenticate Mode: Select the authentication mode here. Options to choose from are **Simple** and **TLS**.

Username: Enter the LDAP server account's username here.

Password: Enter the LDAP server account's password here.

Base DN: Enter the administrator's domain name here.

Account Attribute: Enter the LDAP account attribute string here. This string will be used to search for clients.

Identity: Enter the identity's full path string here. Alternatively, select the **Auto Copy** checkbox to automatically add the generic full path of the web page in the identity field.

Captive Portal Authentication

Encryption Type: **LDAP**

LDAP Settings

Server:

Port:

Authenticate Mode: **Simple**

Username:

Password:

Base DN: (ou=,dc=)

Account Attribute: (ex.cn)

Identity: Auto Copy

Add

Captive Profile	Edit	Delete

Authentication Settings - POP3

Encryption Type: Select the captive portal encryption type here. Options to choose from are **Ticket, User/Password, Remote Radius, LDAP** and **POP3**. In this section we'll discuss the **Ticket** option.

Server: Enter the POP3 server's IP address or domain name here.

Port: Enter the POP server's port number here.

Connection Type: Select the connection type here. Options to choose from are **None** and **SSL/TLS**.

The screenshot shows the 'Captive Portal Authentication' configuration page. At the top, the title is 'Captive Portal Authentication'. Below the title, there are three main sections: 'Encryption Type', 'POP3 Settings', and a table area. The 'Encryption Type' section has a dropdown menu set to 'POP3'. The 'POP3 Settings' section contains three fields: 'Server' (an empty text box), 'Port' (a text box containing '110'), and 'Connection Type' (a dropdown menu set to 'None'). To the right of these settings is an 'Add' button. Below the settings is a table with three columns: 'Captive Profile', 'Edit', and 'Delete'. The table is currently empty.

Captive Profile	Edit	Delete
-----------------	------	--------

Login Page Upload

In this window, users can upload a custom login page picture that will be used by the captive portal feature. Click the **Browse** button to navigate to the image file, located on the managing computer and then click the **Upload** button to initiate the upload.

Upload picture from file: In this field the path to the image file, that will be uploaded, will be displayed. Alternatively, the path can be manually entered here.

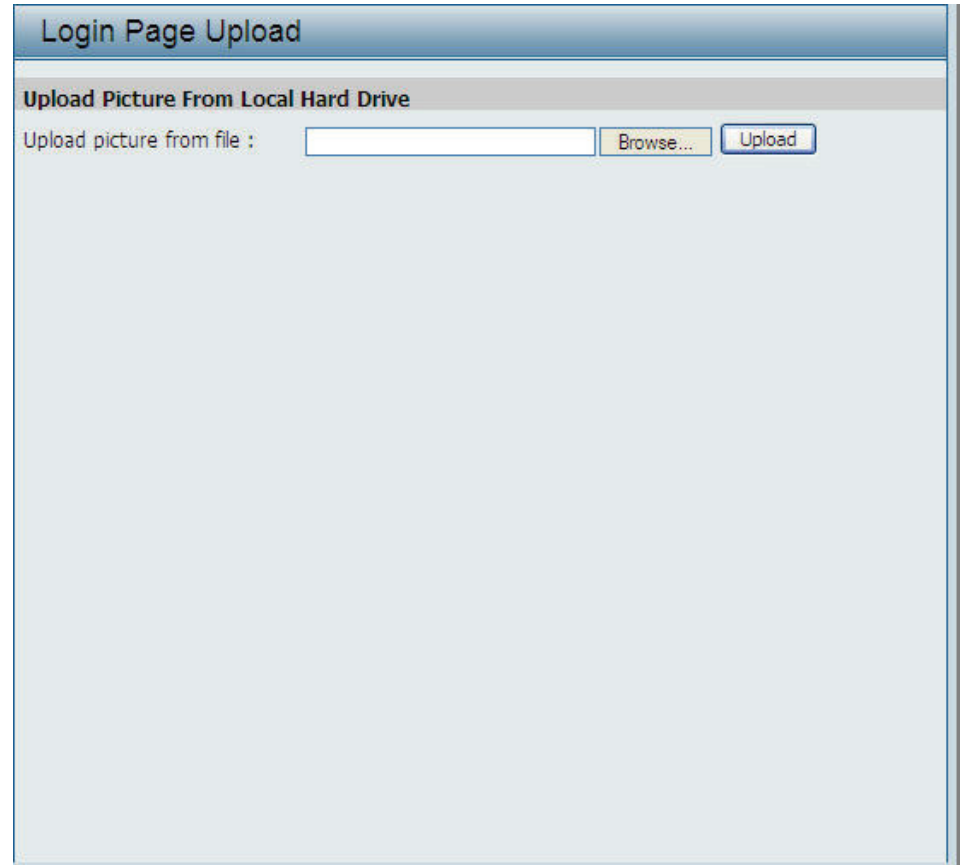

The screenshot shows a web interface window titled "Login Page Upload". Below the title bar is a sub-header "Upload Picture From Local Hard Drive". The main content area contains the text "Upload picture from file :" followed by a text input field. To the right of the input field are two buttons: "Browse..." and "Upload".

Web Redirection

In this windows, users can view and configure the Web redirection settings for the captive portal hosted by this access point. Wireless clients will be redirected to this web site prior and after authentication. Click the **Save** button to accept the changes made.

Web Redirection: Select this checkbox to enable the Web redirection feature.

Web Site: Enter the destination web site's address here.

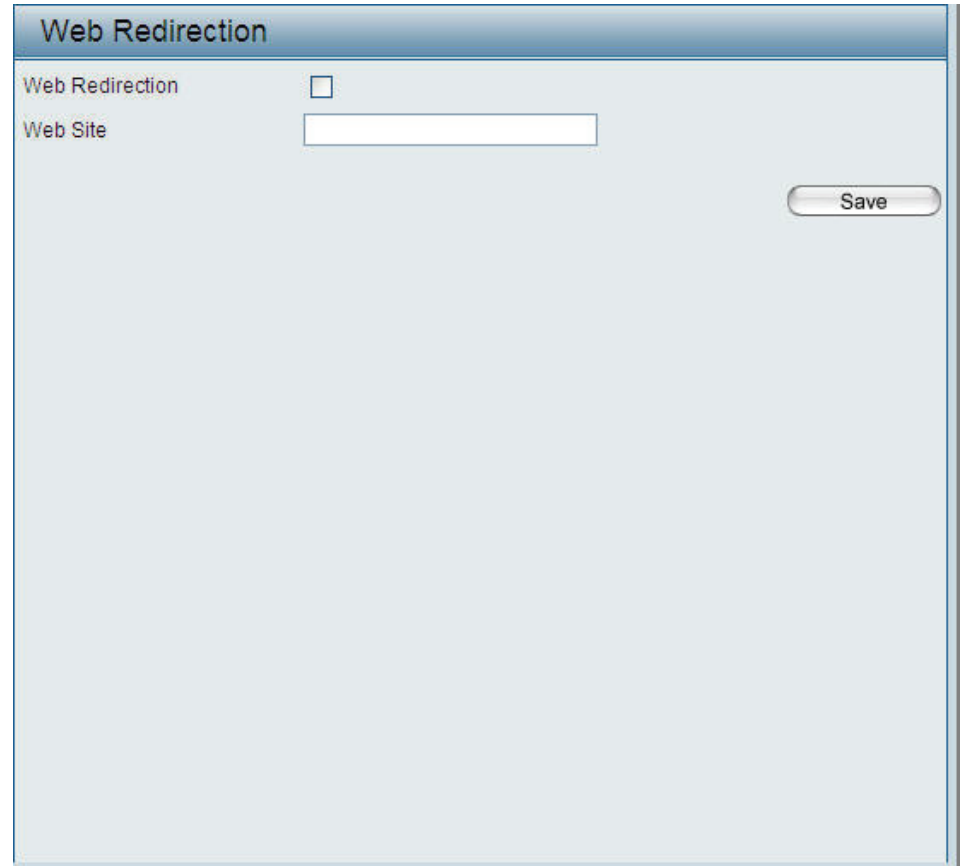

The screenshot shows a configuration window titled "Web Redirection". It contains two main settings: "Web Redirection" with an unchecked checkbox, and "Web Site" with an empty text input field. A "Save" button is located in the bottom right corner of the window.

DHCP Server

Dynamic Pool Settings

The DHCP address pool defines the range of the IP address that can be assigned to stations in the network. A Dynamic Pool allows wireless stations to receive an available IP with lease time control. If needed or required in the network, the DAP-2660 is capable of acting as a DHCP server.

Function Enable/Disable: Dynamic Host Configuration Protocol (DHCP) assigns dynamic IP addresses to devices on the network. This protocol simplifies network management and allows new wireless devices to receive IP addresses automatically without the need to manually assign new IP addresses. Select Enable to allow the DAP-2660 to function as a DHCP server.

IP Assigned From: Input the first IP address available for assignment on your network.

The Range of Pool (1-254): Enter the number of IP addresses available for assignment. IP addresses are increments of the IP address specified in the "IP Assigned From" field.

Subnet Mask: All devices in the network must have the same subnet mask to communicate. Enter the subnet mask for the network here.

Gateway: Enter the IP address of the gateway on the network.

WINS: Specify the Windows Internet Naming Service (WINS) server address for the wireless network. WINS is a system that determines the IP address of a network computer that has a dynamically assigned IP address.

DNS: Enter the IP address of the Domain Name System (DNS) server. The DNS server translates domain names such as www.dlink.com into IP addresses.

Domain Name: Enter the domain name of the network, if applicable. (An example of a domain name is: www.dlink.com.)

Lease Time: The lease time is the period of time before the DHCP server will assign new IP addresses.

The screenshot shows the D-Link DAP-2660 web interface. The main content area is titled "Dynamic Pool Settings". Under "DHCP Server Control", the "Function Enable/Disable" dropdown is set to "Disable". Under "Dynamic Pool Settings", the "IP Assigned From" field is set to "192.168.0.20", "The Range of Pool (1-254)" is set to "235", and "Subnet Mask" is set to "255.255.255.0". Other fields include "Gateway", "WINS", "DNS", "Domain Name" (set to "dlink-ap"), and "Lease Time (60 - 31536000 sec)" (set to "604800"). A "Save" button is located at the bottom right of the configuration area.

Static Pool Setting

The DHCP address pool defines the range of IP addresses that can be assigned to stations on the network. A static pool allows specific wireless stations to receive a fixed IP without time control.

Function Enable/Disable: Dynamic Host Configuration Protocol (DHCP) assigns IP addresses to wireless devices on the network. This protocol simplifies network management and allows new wireless devices to receive IP addresses automatically without the need to manually assign IP addresses. Select Enable to allow the DAP-2660 to function as a DHCP server.

Assigned IP: Use the Static Pool Settings to assign the same IP address to a device every time you start up. The IP addresses assigned in the Static Pool list must NOT be in the same IP range as the Dynamic Pool. After you have assigned a static IP address to a device via its MAC address, click Apply; the device will appear in the Assigned Static Pool at the bottom of the screen. You can edit or delete the device in this list.

Assigned MAC Address: Enter the MAC address of the device requesting association here.

Subnet Mask: Define the subnet mask of the IP address specified in the "IP Assigned From" field.

Gateway: Specify the Gateway address for the wireless network.

WINS: Specify the Windows Internet Naming Service (WINS) server address for the wireless network. WINS is a system that determines the IP address of a network computer with a dynamically assigned IP address, if applicable.

DNS: Enter the DNS server address for your wireless network.

Domain Name: Specify the domain name for the network.

Static Pool Settings

DHCP Server Control

Function Enable/Disable: Enable

Static Pool Setting

Host Name:

Assigned IP:

Assigned MAC Address: : : : : :

Subnet Mask: 255.255.255.0

Gateway:

WINS:

DNS:

Domain Name: dlink-ap

Save

Host Name	MAC Address	IP Address	Edit	Delete

Current IP Mapping List

This window displays information about the current assigned DHCP dynamic and static IP address pools. This information is available when you enable DHCP server on the AP and assign dynamic and static IP address pools.

Current DHCP Dynamic Profile: These are IP address pools the DHCP server has assigned using the dynamic pool setting.

Binding MAC Address: The MAC address of a device on the network that is assigned an IP address from the DHCP dynamic pool.

Assigned IP Address: The current corresponding DHCP-assigned IP address of the device.

Lease Time: The length of time that the dynamic IP address will be valid.

Current DHCP Static Pools: These are the IP address pools of the DHCP server assigned through the static pool settings.

Binding MAC Address: The MAC address of a device on the network that is within the DHCP static IP address pool.

Assigned IP Address: The current corresponding DHCP-assigned static IP address of the device.

Binding MAC Address: The MAC address of a device on the network that is assigned an IP address from the DHCP dynamic pool.

Assigned IP Address: The current corresponding DHCP-assigned static IP address of the device.

Current IP Mapping List			
Current DHCP Dynamic Pools			
Host Name	Binding MAC Address	Assigned IP Address	Lease Time
Current DHCP Static Pools			
Host Name	Binding MAC Address	Assigned IP Address	

Filters

Wireless MAC ACL

This page allows the user to configure Wireless MAC ACL settings for access control.

Wireless Band: Displays the current wireless band rate.

Access Control List: Select **Disable** to disable the filters function.

Select **Accept** to accept only those devices with MAC addresses in the Access Control List. All other devices not on the list will be rejected.

Select **Reject** to reject the devices with MAC addresses on the Access Control List. All other devices not on the list will be accepted.

MAC Address: Enter each MAC address that you wish to include in your filter list, and click Apply.

MAC Address List: When you enter a MAC address, it appears in this list. Highlight a MAC address and click Delete to remove it from this list.

Current Client Information: This table displays information about all the current connected stations.

Wireless MAC ACL Settings

Wireless Band: 2.4GHz

Access Control List: Accept

MAC Address: : : : : : Add

ID	MAC Address	Delete

Current Client Information

MAC Address	SSID	Band	Authentication	Signal	Add
00:1F:3B:AD:35:0B	dlink	N	OPEN	98%	<input type="checkbox"/>

Upload ACL File

Upload File : Browse... Upload

Download ACL File

Load ACL File to Local Hard Driver : Download

Save

WLAN Partition

This page allows the user to configure a WLAN Partition.

Wireless Band: Displays the current wireless band.

Link Integrity: Select **Enable** or **Disable**. If the Ethernet connection between the LAN and the AP is disconnected, enabling this feature will cause the wireless segment associated with the AP to be disassociated from the AP.

Ethernet WLAN Access: The default is Enable. When disabled, all data from the Ethernet to associated wireless devices will be blocked. Wireless devices can still send data to the Ethernet.

Internal Station Connection: The default value is Enable, which allows stations to intercommunicate by connecting to a target AP. When disabled, wireless stations cannot exchange data on the same Multi-SSID. In Guest mode, wireless stations cannot exchange data with any station on your network.

WLAN Partition		
Wireless Band	2.4GHz ▼	
Link Integrity	Disable ▼	
Ethernet to WLAN Access	Enable ▼	
Internal Station Connection		
Primary SSID	<input checked="" type="radio"/> Enable	<input type="radio"/> Disable <input type="radio"/> Guest mode
Multi-SSID 1	<input type="radio"/> Enable	<input type="radio"/> Disable <input type="radio"/> Guest mode
Multi-SSID 2	<input type="radio"/> Enable	<input type="radio"/> Disable <input type="radio"/> Guest mode
Multi-SSID 3	<input type="radio"/> Enable	<input type="radio"/> Disable <input type="radio"/> Guest mode
Multi-SSID 4	<input type="radio"/> Enable	<input type="radio"/> Disable <input type="radio"/> Guest mode
Multi-SSID 5	<input type="radio"/> Enable	<input type="radio"/> Disable <input type="radio"/> Guest mode
Multi-SSID 6	<input type="radio"/> Enable	<input type="radio"/> Disable <input type="radio"/> Guest mode
Multi-SSID 7	<input type="radio"/> Enable	<input type="radio"/> Disable <input type="radio"/> Guest mode
<input type="button" value="Save"/>		

Traffic Control

Uplink/Downlink Setting

The uplink/downlink setting allows users to customize the downlink and uplink interfaces including specifying downlink/uplink bandwidth rates in Mbits per second. These values are also used in the QoS and Traffic Manager windows. Once the desired uplink and downlink settings are finished, click the **Save** button to let your changes take effect.

Downlink Bandwidth: The downlink bandwidth in Mbits per second.

Uplink Bandwidth: Uplink Bandwidth: The uplink bandwidth in Mbits per second.

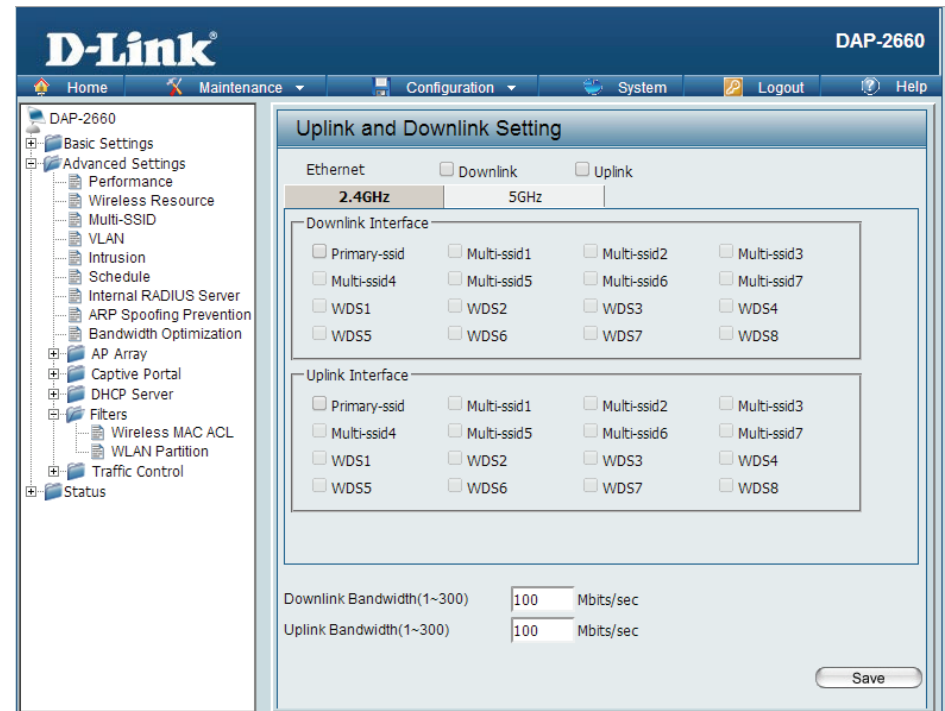

QoS

Quality of Service (QoS) enhances the experience of using a network by prioritizing the traffic of different applications. The DAP-2660 supports four priority levels. Once the desired QoS settings are finished, click the **Save** button to let your changes take effect.

Enable QoS: Check this box to allow QoS to prioritize traffic. Use the drop-down menus to select the four levels of priority. Click the Save button when you are finished.

Downlink Bandwidth: Downlink Bandwidth: The downlink bandwidth in Mbits per second. This value is entered in the Uplink/Downlink Setting window.

Uplink Bandwidth: Uplink Bandwidth: The uplink bandwidth in Mbits per second. This value is entered in the Uplink/Downlink Setting window.

The screenshot shows the QoS configuration window with the following settings:

Category	Value	Unit
Downlink Bandwidth	100	Mbits/sec
Uplink Bandwidth	100	Mbits/sec
ACK/DHCP/ICMP/DNS Priority	Highest Priority	Limit: 100 % Port: 53,67,68,546,547
Web Traffic Priority	Third Priority	Limit: 100 % Port: 80,443,3128,8080
Mail Traffic Priority	Second Priority	Limit: 100 % Port: 25,110,465,995
Ftp Traffic Priority	Low Priority	Limit: 100 % Port: 20,21
User Defined-1 Priority	Highest Priority	Limit: 100 % Port: 0 - 0
User Defined-2 Priority	Second Priority	Limit: 100 % Port: 0 - 0
User Defined-3 Priority	Third Priority	Limit: 100 % Port: 0 - 0
User Defined-4 Priority	Low Priority	Limit: 100 % Port: 0 - 0
Other Traffic Priority	Low Priority	Limit: 100 %

A **Save** button is located at the bottom right of the window.

Traffic Manager

The traffic manager feature allows users to create traffic management rules that specify how to deal with listed client traffic and specify downlink/ uplink speed for new traffic manager rules. Click the **Save** button to let your changes take effect.

Traffic Manager: Use the drop-down menu to **Enable** the traffic manager feature.

Unlisted Client Traffic: Select **Deny** or **Forward** to determine how to deal with unlisted client traffic.

Downlink Bandwidth: The downlink bandwidth in Mbits per second. This value is entered in the Uplink/Downlink Setting window.

Uplink Bandwidth: Uplink Bandwidth: The uplink bandwidth in Mbits per second. This value is entered in the Uplink/Downlink Setting window.

Traffic Manager

Traffic Manager Disable ▾

Unlisted Clients Traffic Deny Forward

Downlink Bandwidth Mbits/sec

Uplink Bandwidth Mbits/sec

Add Traffic Manager Rule

Name

Client IP(optional)

Client MAC(optional)

Downlink Speed Mbits/sec

Uplink Speed Mbits/sec

Traffic Manager Rules

Name	Client IP	Client MAC	Downlink Speed	Uplink Speed	Edit	Del
<input type="button" value="Save"/>						

Status

In the Status Section the user can monitor and view configuration settings of the access point. Here the user can also view statistics about client information, WDS information and more. The following pages will explain settings found in the Status section in more detail.

The screenshot shows the D-Link DAP-2660 web interface. The top navigation bar includes Home, Maintenance, Configuration, System, Logout, and Help. The left sidebar shows a tree view with 'Status' selected. The main content area displays the following information:

Device Information	
Firmware Version:1.00	
Ethernet MAC Address:	00:03:26:60:36:40
Wireless MAC Address(2.4GHz):	Primary: 00:03:26:60:36:40 SSID 1~7: 00:03:26:60:36:41 ~ 00:03:26:60:36:47
Wireless MAC Address(5GHz):	Primary: 00:03:26:60:36:48 SSID 1~7: 00:03:26:60:36:49 ~ 00:03:26:60:36:4f
Ethernet	
IP Address	192.168.0.50
Subnet Mask	255.255.255.0
Gateway	N/A
DNS	
Wireless (2.4GHz)	
Network Name (SSID)	dlink
Channel	1
Data Rate	Auto
Security	None
Wireless (5GHz)	
Network Name (SSID)	dlink
Channel	36
Data Rate	Auto

Device Information

This page displays the current information like firmware version, Ethernet and wireless parameters, as well as the information regarding CPU and memory utilization.

Device Information: This read-only window displays the configuration settings of the DAP-2660, including the firmware version and the device's MAC address.

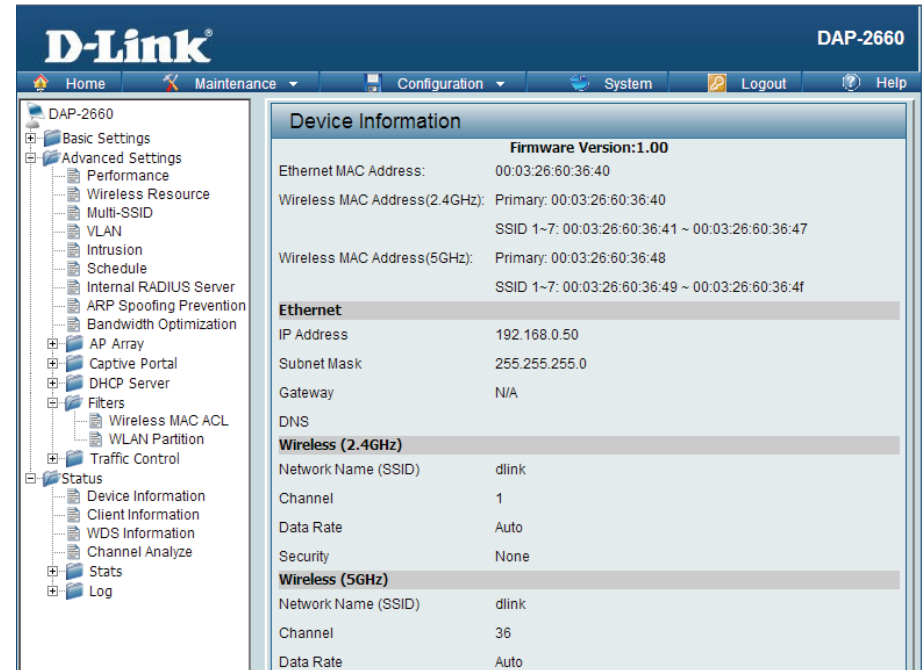

The screenshot shows the D-Link DAP-2660 web interface. The top navigation bar includes Home, Maintenance, Configuration, System, Logout, and Help. The left sidebar shows a tree view of configuration options, with 'Status' > 'Device Information' selected. The main content area displays the 'Device Information' page with the following details:

Device Information	
Firmware Version: 1.00	
Ethernet MAC Address:	00:03:26:60:36:40
Wireless MAC Address(2.4GHz):	Primary: 00:03:26:60:36:40 SSID 1~7: 00:03:26:60:36:41 ~ 00:03:26:60:36:47
Wireless MAC Address(5GHz):	Primary: 00:03:26:60:36:48 SSID 1~7: 00:03:26:60:36:49 ~ 00:03:26:60:36:4f
Ethernet	
IP Address	192.168.0.50
Subnet Mask	255.255.255.0
Gateway	N/A
DNS	
Wireless (2.4GHz)	
Network Name (SSID)	dlink
Channel	1
Data Rate	Auto
Security	None
Wireless (5GHz)	
Network Name (SSID)	dlink
Channel	36
Data Rate	Auto

Client Information

This page displays the associated clients SSID, MAC, band, authentication method, signal strength, and power saving mode for the DAP-2660 network.

Client Information: This window displays the wireless client information for clients currently connected to the DAP-2660.

SSID: Displays the SSID of the client.

MAC: Displays the MAC address of the client.

Band: Displays the wireless band that the client is connected to.

Authentication: Displays the type of authentication being used.

RSSI: Displays the client's signal strength.

Power Saving Mode: Displays the status of the power saving feature.

Client Information						
Client Information		Station association (2.4GHz) : 2				
SSID	MAC	Band	Authentication	RSSI	Power Saving Mode	
Primary SSID	F8:A4:5F:72:C7:5C	N	OPEN	11%	On	
Primary SSID	04:FE:31:D5:08:06	N	OPEN	67%	Off	
Client Information		Station association(5GHz) : 0				
SSID	MAC	Band	Authentication	RSSI	Power Saving Mode	

WDS Information Page

This page displays the access points SSID, MAC, band, authentication method, signal strength, and status for the DAP-2660's Wireless Distribution System network.

WDS Information: This window displays the Wireless Distribution System information for clients currently connected to the DAP-2660.

Name: Displays the SSID of the client.

MAC: Displays the MAC address of the client.

Authentication: Displays the type of authentication being used.

Signal: Displays the client's signal strength.

Status: Displays the status of the power saving feature.



WDS Information				
Channel : 1 (2.412 GHz)				
Name	MAC	Authentication	Signal	Status

WDS Information				
Channel : 36 (5.18 GHz)				
Name	MAC	Authentication	Signal	Status

Channel Analyze

Wireless Band: Select either 2.4Ghz or 5GHz.

Detect: Click the Detect button to scan.

AP List: This will list the transmitting channels and quality.

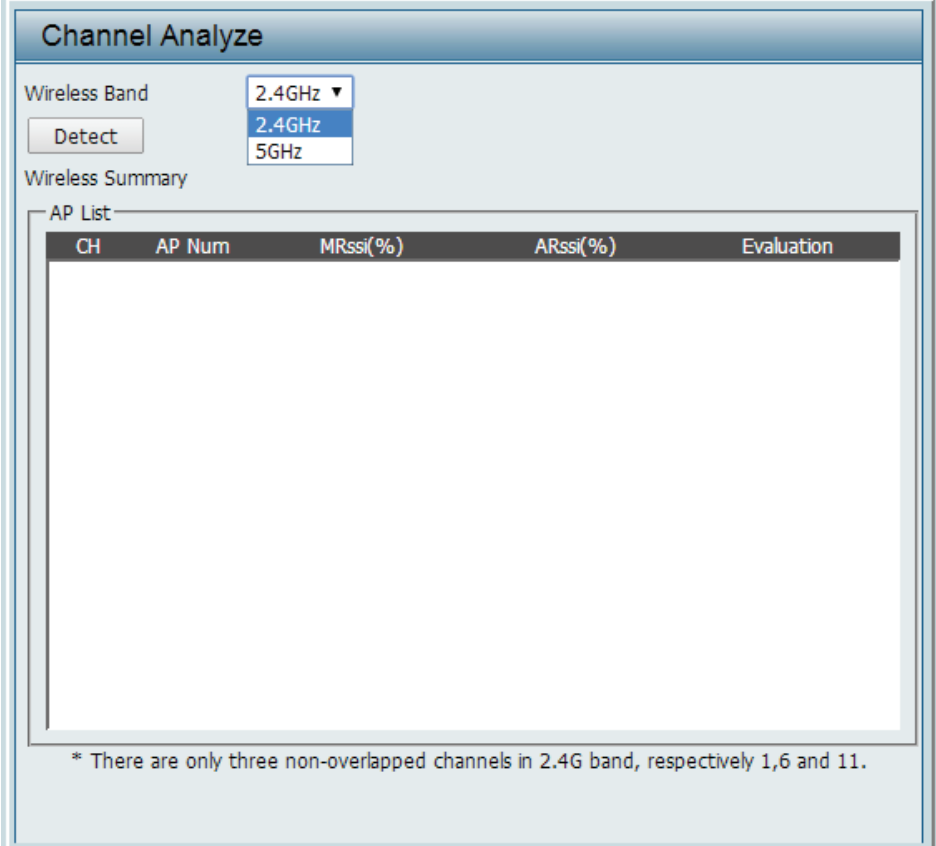

Channel Analyze

Wireless Band: 2.4GHz ▾
2.4GHz
5GHz

Detect

Wireless Summary

AP List

CH	AP Num	MRssi(%)	ARssi(%)	Evaluation
----	--------	----------	----------	------------

* There are only three non-overlapped channels in 2.4G band, respectively 1,6 and 11.

Stats Page

Ethernet Traffic Statistics

Displays wired interface network traffic information.

Ethernet Traffic Statistics: This page displays transmitted and received count statistics for packets and bytes.

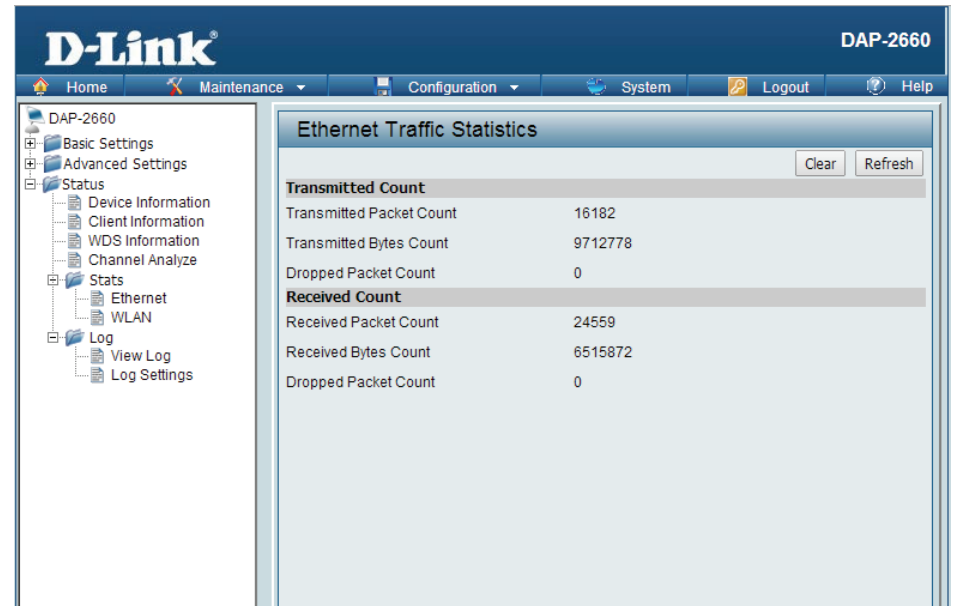

WLAN Traffic Statistics

Displays throughput, transmitted frame, received frame, and WEP frame error information for the AP network.

WLAN Traffic Statistics: This page displays wireless network statistics for data throughput, transmitted and received frames, and frame errors.

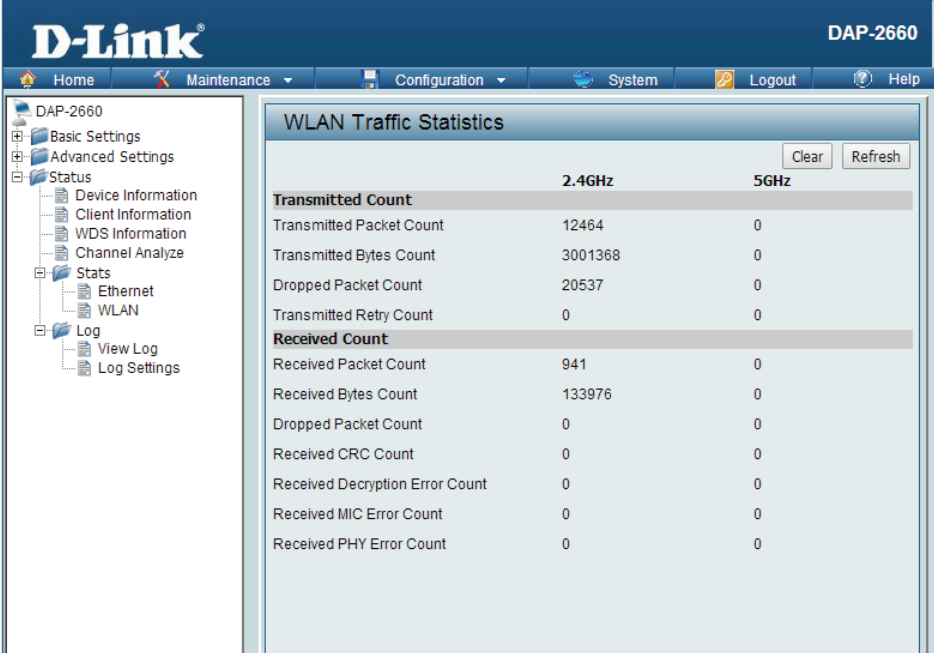

The screenshot shows the D-Link DAP-2660 web interface. The navigation menu on the left includes: DAP-2660, Basic Settings, Advanced Settings, Status (Device Information, Client Information, WDS Information, Channel Analyze), Stats (Ethernet, WLAN), Log (View Log, Log Settings). The main content area is titled "WLAN Traffic Statistics" and features a "Clear" and "Refresh" button. The table below displays statistics for 2.4GHz and 5GHz bands.

	2.4GHz	5GHz
Transmitted Count		
Transmitted Packet Count	12464	0
Transmitted Bytes Count	3001368	0
Dropped Packet Count	20537	0
Transmitted Retry Count	0	0
Received Count		
Received Packet Count	941	0
Received Bytes Count	133976	0
Dropped Packet Count	0	0
Received CRC Count	0	0
Received Decryption Error Count	0	0
Received MIC Error Count	0	0
Received PHY Error Count	0	0

Log

View Log

The AP's embedded memory holds logs here. The log information includes but is not limited to the following items: cold start AP, upgrading firmware, client associate and disassociate with AP, and web login. The web page holds up to 500 logs.

View Log: The AP's embedded memory displays system and network messages including a time stamp and message type. The log information includes but is not limited to the following items: cold start AP, upgrading firmware, client associate and disassociate with AP, and web login. The web page holds up to 500 logs.

The screenshot shows the D-Link DAP-2660 web interface. The top navigation bar includes Home, Maintenance, Configuration, System, Logout, and Help. The left sidebar menu shows the following structure:

- DAP-2660
 - Basic Settings
 - Advanced Settings
 - Status
 - Device Information
 - Client Information
 - WDS Information
 - Channel Analyze
 - Stats
 - Ethernet
 - WLAN
 - Log
 - View Log
 - Log Settings

The main content area is titled "View Log" and includes navigation buttons: First Page, Last Page, Previous, Next, and Clear. Below the buttons, it indicates "Page 1 of 3". The log entries are displayed in a table with the following columns: Time, Priority, and Message.

Time	Priority	Message
Uptime 0 day 04:04:45	[SYSACT]	Web login success from 192.168.0.2
Uptime 0 day 03:16:01	[Wireless]	2.4G:Deauth:Aging STA F8:A4:5F:72:C7:5C
Uptime 0 day 03:09:00	[SYSACT]	Web logout from 192.168.0.2
Uptime 0 day 03:05:16	[Wireless]	2.4G:Deauth:Aging STA 04:FE:31:D5:08:06
Uptime 0 day 03:01:47	[SYSACT]	Web login success from 192.168.0.2
Uptime 0 day 03:00:05	[Wireless]	2.4G:Association Success:STA 04:FE:31:D5:08:06
Uptime 0 day 02:54:35	[SYSACT]	Web logout from 192.168.0.2
Uptime 0 day 02:51:29	[SYSACT]	Web login success from 192.168.0.2
Uptime 0 day 02:49:22	[Wireless]	2.4G:Association Success:STA F8:A4:5F:72:C7:5C
Uptime 0 day 02:47:01	[SYSACT]	Web login success from 192.168.0.2
Uptime 0 day 02:09:31	[Wireless]	2.4G:Deauth:Aging STA E8:99:C4:A2:01:D0
Uptime 0 day 02:04:10	[Wireless]	2.4G:Association Success:STA E8:99:C4:A2:01:D0
Uptime 0 day 01:23:01	[Wireless]	2.4G:Deauth:Aging STA E8:99:C4:AE:0C:22
Uptime 0 day 01:17:46	[Wireless]	2.4G:Deauth:Aging STA 04:FE:31:D5:08:06
Uptime 0 day 01:17:33	[Wireless]	2.4G:Association Success:STA E8:99:C4:AE:0C:22
Uptime 0 day 01:14:55	[Wireless]	2.4G:Association Success:STA 04:FE:31:D5:08:06

Log Settings

Enter the log server's IP address to send the log to that server. Check or uncheck System Activity, Wireless Activity, or Notice to specify what kind of log type you want it to log.

Log Server/IP Address: Enter the IP address of the server you would like to send the DAP-2660 log to.

Log Type: Check the box for the type of activity you want to log. There are three types: System Activity, Wireless Activity, and Notice.

E-mail Notification: Support Simple Mail Transfer Protocol for log schedule and periodical change key. It can not support Gmail SMTP port 465. Please set to Gmail SMTP port 25 or 587.

E-mail Log Schedule: Use the drop-down menu to set the e-mail log schedule.

The screenshot shows the D-Link DAP-2660 web interface. The top navigation bar includes Home, Maintenance, Configuration, System, Logout, and Help. The left sidebar shows a tree view with categories: DAP-2660, Basic Settings, Advanced Settings, Status (Device Information, Client Information, WDS Information, Channel Analyze), Stats (Ethernet, WLAN), Log (View Log, Log Settings). The main content area is titled 'Log Settings' and contains the following sections:

- Log Settings:**
 - Log Server / IP Address: [Text Input Field]
 - Log Type:
 - System Activity
 - Wireless Activity
 - Notice
- Email Notification:**
 - Email Notification: Enable
 - Outgoing mail server (SMTP): [Internal ▼]
 - Authentication: Enable
 - SSL/TLS: Enable
 - From Email Address: [Text Input Field]
 - To Email Address: [Text Input Field]
 - Email Server Address: [Text Input Field]
 - SMTP Port: [Text Input Field]
 - User Name: [Text Input Field]
 - Password: [Text Input Field]
 - Confirm Password: [Text Input Field]
- Email Log Schedule:**
 - Schedule: [0 ▼] hours or when Log is full

A 'Save' button is located at the bottom right of the form.

Maintenance Section

In the Status Section the user can monitor and view configuration settings of the access point. Here the user can also view statistics about client information, WDS information and more. The following pages will explain settings found in the maintenance section in more detail.

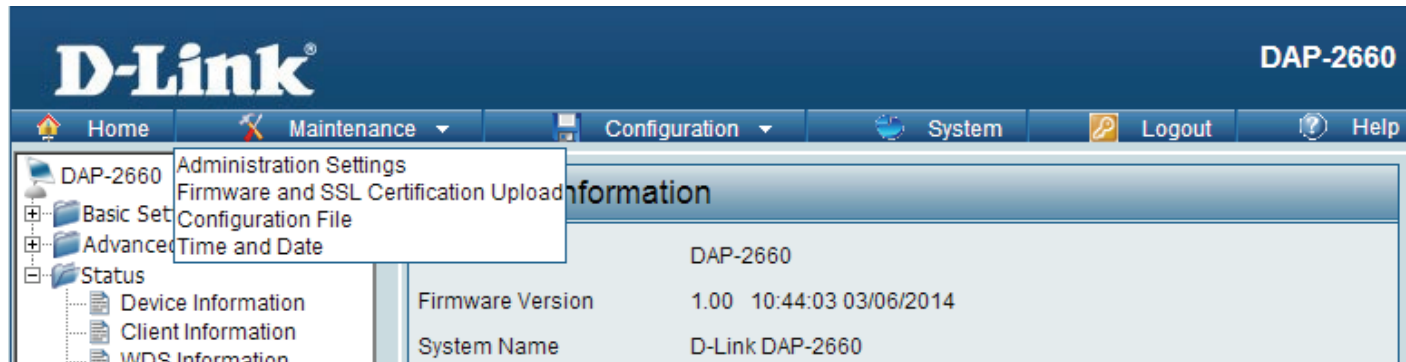

Administration

Limit Administrator

Check one or more of the five main categories to display the various hidden administrator parameters and settings displayed on the next five pages. Each of the five main categories display various hidden administrator parameters and settings.

Limit Administrator VLAN ID: Check the box provided and the ID: enter the specific VLAN ID that the administrator will be allowed to log in from.

Limit Administrator IP: Check to enable the Limit Administrator IP address.

IP Range: Enter the IP address range that the administrator will be allowed to log in from and then click the Add button.

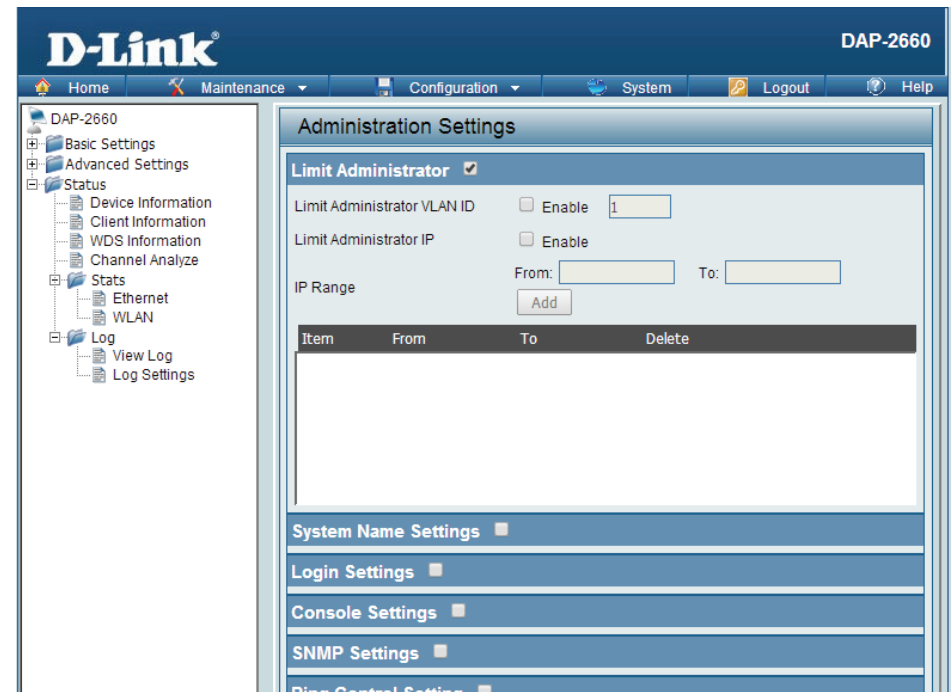

The screenshot shows the D-Link DAP-2660 Administration Settings page. The left sidebar contains a tree view with categories: Basic Settings, Advanced Settings, Status, Device Information, Client Information, WDS Information, Channel Analyze, Stats, Ethernet, WLAN, Log, View Log, and Log Settings. The main content area is titled "Administration Settings" and features a "Limit Administrator" section with a checked checkbox. Below this, there are three rows of settings: "Limit Administrator VLAN ID" with an "Enable" checkbox and a text input field containing "1"; "Limit Administrator IP" with an "Enable" checkbox; and "IP Range" with "From:" and "To:" text input fields and an "Add" button. Below these settings is a table with columns "Item", "From", "To", and "Delete". At the bottom of the page, there are sections for "System Name Settings", "Login Settings", "Console Settings", "SNMP Settings", and "Ring Control Settings", each with a small square icon.

System Name Settings

Each of the five main categories display various hidden administrator parameters and settings.

System Name: The name of the device. The default name is D-Link DAP-2660.

Location: The physical location of the device, e.g. 72nd Floor, D-Link HQ.

System Name Settings <input checked="" type="checkbox"/>	
System Name	<input type="text" value="D-Link DAP-2553"/>
Location	<input type="text"/>

Login Settings

Each of the five main categories display various hidden administrator parameters and settings.

User Name: Enter a user name. The default is admin.

Old Password: When changing your password, enter the old password here.

New Password: When changing your password, enter the new password here. The password is case-sensitive. "A" is a different character than "a." The length should be between 0 and 12 characters.

Confirm Password: Enter the new password a second time for confirmation purposes.

Login Settings <input checked="" type="checkbox"/>	
Login Name	<input type="text" value="admin"/>
Old Password	<input type="text"/>
New Password	<input type="text"/>
Confirm Password	<input type="text"/>

Console Settings

Each of the five main categories display various hidden administrator parameters and settings.

Status: Status is enabled by default. Uncheck the box to disable the console.

Console Protocol: Select the type of protocol you would like to use, Telnet or SSH.

Time-out: Set to 1 Min, 3 Mins, 5 Mins, 10 Mins, 15 Mins or Never.

Console Settings <input checked="" type="checkbox"/>	
Status	<input checked="" type="checkbox"/> Enable
Console Protocol	<input checked="" type="radio"/> Telnet <input type="radio"/> SSH
Timeout	3 Mins <input type="button" value="v"/>

SNMP Settings

Each of the five main categories display various hidden administrator parameters and settings.

Status: Check the box to enable the SNMP functions. This is enabled by default.

Public Community String: Enter the public SNMP community string.

Private Community String: Enter the private SNMP community string.

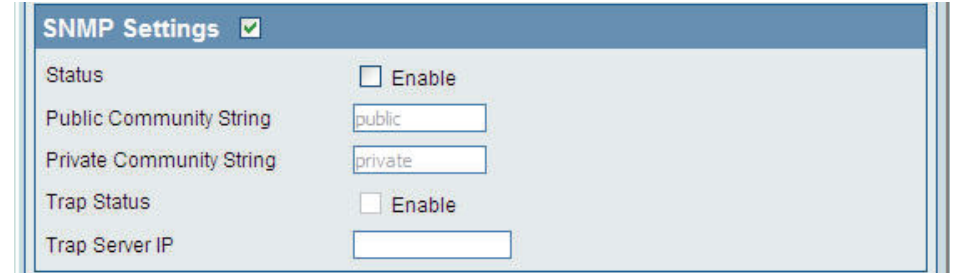

SNMP Settings <input checked="" type="checkbox"/>	
Status	<input type="checkbox"/> Enable
Public Community String	<input type="text" value="public"/>
Private Community String	<input type="text" value="private"/>
Trap Status	<input type="checkbox"/> Enable
Trap Server IP	<input type="text"/>

Administration

Central WiFiManager Settings

The Central WiFiManager section is used to create a set of APs on the Internet to be organized into a single group in order to increase ease of management. Central WiFiManager and AP Array are mutually exclusive functions.

Enable Central WiFiManager: Select to enable or disable the Central WiFiManager.

Enable Backup Central WiFiManager: Select to enable or disable the backup Central WiFiManager.

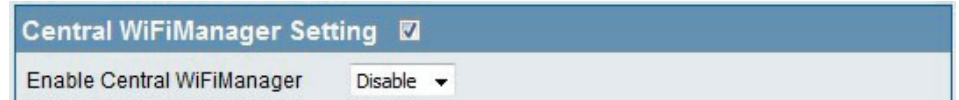

Firmware and SSL Upload

This page allows the user to perform a firmware upgrade. A Firmware upgrade is a function that upgrade the running software used by the access point. This is a useful feature that prevents future bugs and allows for new features to be added to this product. Please go to your local D-Link website to see if there is a newer version firmware available.

Firmware and SSL Certification Upload: You can upload files to the access point.

Upload Firmware from Local Hard Drive: The current firmware version is displayed above the file location field. After the latest firmware is downloaded, click on the "Choose File" button to locate the new firmware. Once the file is selected, click on the "Open" and "Upload" button to begin updating the firmware. Please don't turn the power off while upgrading.

Upload SSL Certification from Local Hard Drive: After you have downloaded a SSL certification to your local drive, click "Choose File." Select the certification and click "Open" and "Upload" to complete the upgrade.

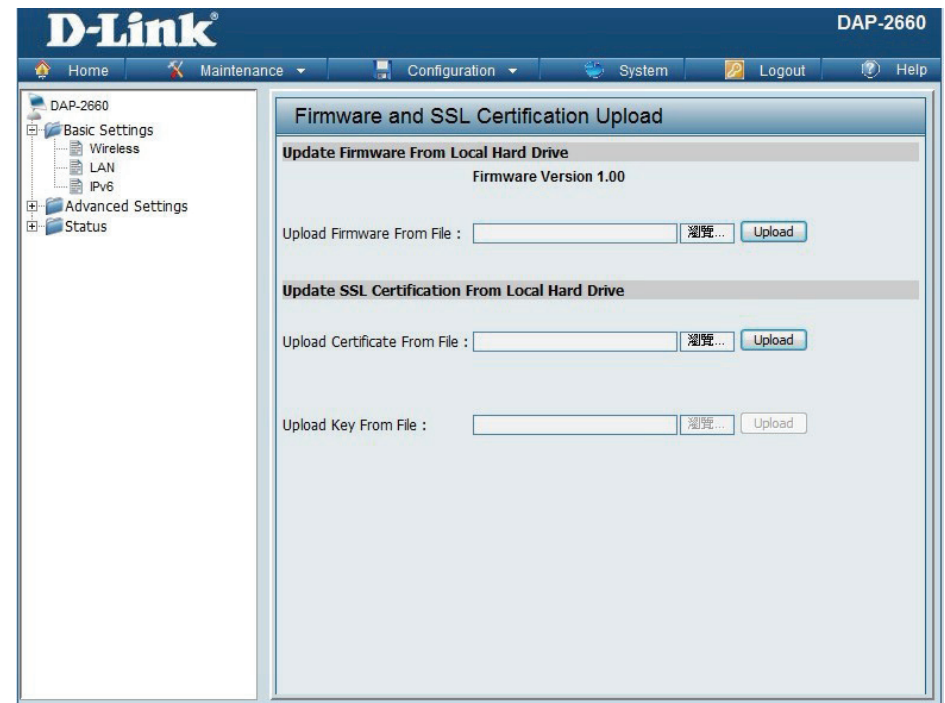

Configuration File Upload

This page allows the user to backup and recover the current configuration of the access point in case of a unit failure.

Configuration File Upload and Download: You can upload and download configuration files of the access point.

Upload Configuration File: Browse to the saved configuration file you have in local drive and click "Open" and "Upload" to update the configuration.

Download Configuration File: Click "Download" to save the current configuration file to your local disk. Note that if you save one configuration file with the administrator's password now, after resetting your DAP-2660 and then updating to this saved configuration file, the password will be gone.

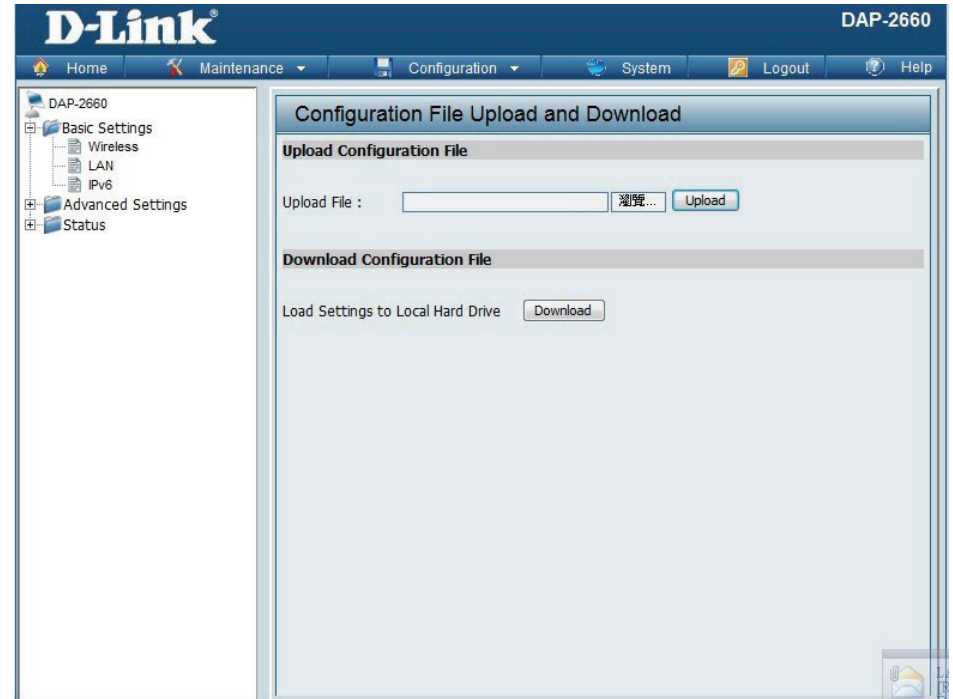

Time and Date Settings

Enter the NTP server IP, choose the time zone, and enable or disable daylight saving time.

Current Time: Displays the current time and date settings.

Enable NTP Server: Check to enable the AP to get system time from an NTP server from the Internet.

NTP Server: Enter the NTP server IP address.

Time Zone: Use the drop-down menu to select your correct Time Zone.

Enable Daylight Saving: Check the box to enable Daylight Saving Time.

Daylight Saving Dates: Use the drop-down menu to select the correct Daylight Saving offset.

Set the Date and Time Manually: A user can either manually set the time for the AP here, or click the Copy Your Computer's Time Settings button to copy the time from the computer in use (Make sure that the computer's time is set correctly).

The screenshot shows the D-Link DAP-2660 web interface. The top navigation bar includes Home, Maintenance, Configuration, System, Logout, and Help. The left sidebar shows the navigation menu with DAP-2660, Basic Settings, Advanced Settings, and Status. The main content area is titled "Time and Date Settings" and contains the following sections:

- Time Configuration:** Shows the current time as 01/01/1970 04:15:56.
- Automatic Time Configuration:**
 - Enable NTP Server:
 - NTP Server:
 - Time Zone: (GMT+08:00) Ulaan Bataar
 - Enable Daylight Saving:
- Set the Date and Time Manually:**
 - Date And Time:
 - Year: 2014
 - Month: Mar
 - Day: 12
 - Hour: 15
 - Minute: 13
 - Second: 5
 - Copy Your Computer's Time Settings:

A Save button is located at the bottom right of the form.

Configuration and System

These options are the remaining option to choose from in the top menu. Configuration allows the user to save and activate or discard the configurations done. System allows the user to restart the unit, perform a factory reset or clear the language pack settings. Logout allows the user to safely log out from the access point's web configuration. Help allows the user to read more about the given options to configure without the need to consult the manual. The following pages will explain settings found in the configuration and system section in more detail.

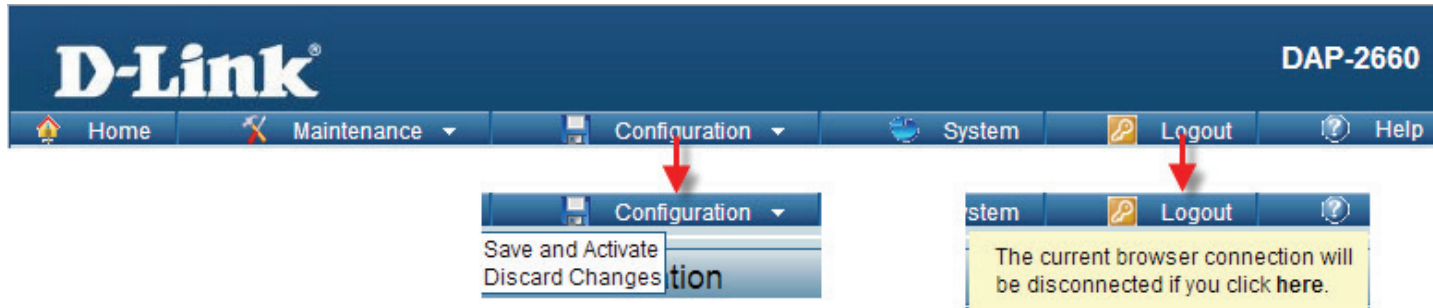

System Settings

On this page the user can restart the unit, perform a factory reset of the access point or clear the added language pack.

Restart the Device: Click Restart to restart the DAP-2660.

Restore to Factory Default Settings: Click Restore to restore the DAP-2660 back to factory default settings.

Clear Language Pack: Click to clear the current Language pack running.

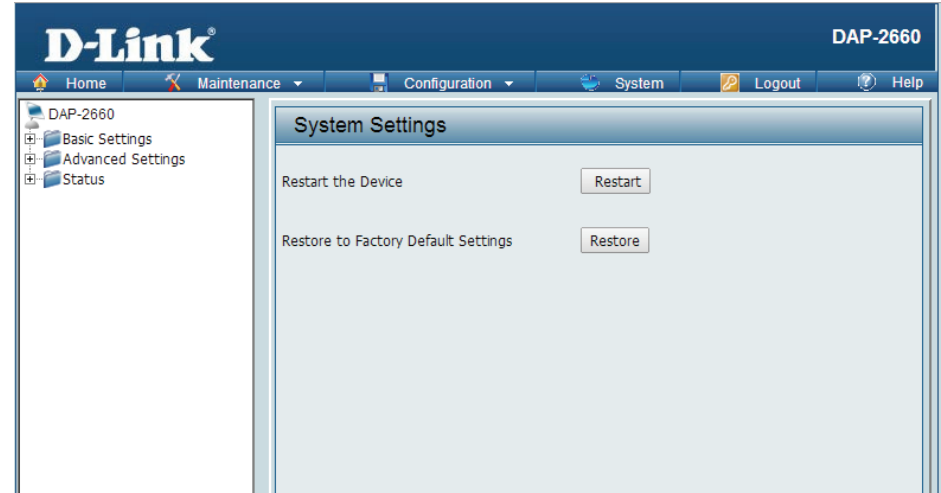

Help

The help page is useful to view a brief description of a function available on the access point in case the manual is not present.

Help: Scroll down the Help page for topics and explanations.

Basic Settings

Wireless Settings

Allow you to change the wireless settings to fit an existing wireless network or to customize your wireless network.

Wireless Band
Operating frequency band. Choose 2.4GHz for visibility to legacy devices and for longer range. Choose 5GHz for least interference; interference can hurt performance. This AP will operate one band at a time.

Application
This option allows the user to choose for indoor or outdoor mode at the 5G Band.

Mode
Select a function mode to configure your wireless network. Function modes include AP, WDS (Wireless Distribution System) with AP, WDS and Wireless Client. Function modes are designed to support various wireless network topology and applications.

Network Name (SSID)
Also known as the Service Set Identifier, this is the name designated for a specific wireless local area network (WLAN). The factory default setting is "dlink". The SSID can be easily changed to connect to an existing wireless network or to establish a new wireless network.

SSID Visibility
Indicate whether or not the SSID of your wireless network will be broadcasted. The default value of SSID Visibility is set to "Enable," which allow wireless clients to detect the wireless network. By changing this setting to "Disable," wireless clients can no longer detect the wireless network and can only connect if they have the correct SSID entered.

Auto Channel Selection
If you check Auto Channel Scan, everytime when AP is booting up, the AP will automatically find the best channel to use. This is enabled by default.

Channel
Indicate the channel setting for the DAP-2553. By default, the AP is set to Auto Channel Scan. The Channel can be changed to fit the channel setting for an existing wireless network or to customize the wireless network.

Channel Width
Allows you to select the channel width you would like to operate in. Select 20MHz if you are not using any 802.11n wireless clients. Auto 20/40MHz allows your to use both 802.11n and non-802.11n wireless devices in your network.

Authentication

Knowledge Base

Wireless Basics

D-Link wireless products are based on industry standards to provide high-speed wireless connectivity that is easy to use within your home, business or public access wireless networks. D-Link wireless products provides you with access to the data you want, whenever and wherever you want it. Enjoy the freedom that wireless networking can bring to you.

WLAN use is not only increasing in both home and office environments, but in public areas as well, such as airports, coffee shops and universities. Innovative ways to utilize WLAN technology are allowing people to work and communicate more efficiently. Increased mobility and the absence of cabling and other types of fixed infrastructure have proven to be beneficial to many users.

Wireless adapter cards used on laptop and desktop systems support the same protocols as Ethernet adapter cards, allowing wireless users to use the same applications as those used on a wired network.

People use WLAN technology for many different purposes:

- **Mobility** - productivity increases when people can have access to data in any location within the operating range of their WLAN. Management decisions based on real-time information can significantly improve the efficiency of a worker.
- **Low implementation costs** - WLANs are easy to set up, manage, change and relocate. Networks that frequently change can benefit from WLAN's ease of implementation. WLANs can operate in locations where installation of wiring may be impractical.
- **Installation and network expansion** - by avoiding the complications of troublesome cables, a WLAN system can be fast and easy during installation, especially since it can eliminate the need to pull cable through walls and ceilings. Wireless technology provides more versatility by extending the network beyond the home or office.
- **Inexpensive solution** - wireless network devices are as competitively priced as conventional Ethernet network devices. The DAP-2660 saves money by providing users with multi-functionality configurable in four different modes.
- **Scalability** - Configurations can be easily changed and range from Peer-to-Peer networks, suitable for a small number of users to larger Infrastructure networks to accommodate hundreds or thousands of users, depending on the number of wireless devices deployed.

Wireless Installation Considerations

The D-Link Access Point lets you access your network using a wireless connection from virtually anywhere within the operating range of your wireless network. Keep in mind, however, that the number, thickness and location of walls, ceilings, or other objects that the wireless signals must pass through, may limit the range. Typical ranges vary depending on the types of materials and background RF (radio frequency) noise in your home or business. The key to maximizing wireless range is to follow these basic guidelines:

1. Keep the number of walls and ceilings between the access point and other network devices to a minimum. Each wall or ceiling can reduce your adapter's range from 3-90 feet (1-30 meters.) Position your devices so that the number of walls or ceilings is minimized.
2. Be aware of the direct line between network devices. A wall that is 1.5 feet thick (.5 meters), at a
3. 45-degree angle appears to be almost 3 feet (1 meter) thick. At a 2-degree angle it looks over 42 feet (14 meters) thick! Position devices so that the signal will travel straight through a wall or ceiling (instead of at an angle) for better reception.
4. Building Materials make a difference. A solid metal door or aluminum studs may have a negative effect on the range. Try to position access points, wireless routers, and computers so that the signal passes through drywall or open doorways. Materials and objects such as glass, steel, metal, walls with insulation, water (fish tanks), mirrors, file cabinets, brick, and concrete will degrade your wireless signal.
5. Keep your product away (at least 3-6 feet or 1-2 meters) from electrical devices or appliances that generate RF noise.
6. If you are using 2.4GHz cordless phones or X-10 (wireless products such as ceiling fans, lights, and home security systems), your wireless connection may degrade dramatically or drop completely. Make sure your 2.4GHz phone base is as far away from your wireless devices as possible. The base transmits a signal even if the phone is not in use.

Troubleshooting

This chapter provides solutions to problems that can occur during the installation and operation of the DAP-2660. Read the following descriptions if you are having problems. (The examples below are illustrated in Windows® XP. If you have a different operating system, the screenshots on your computer will look similar to the following examples.)

Why can't I access the web-based configuration utility?

When entering the IP address of the D-Link access point (192.168.0.50 for example), you are not connecting to a website on the Internet or have to be connected to the Internet. The device has the utility built-in to a ROM chip in the device itself. Your computer must be on the same IP subnet to connect to the web-based utility.

- Make sure you have an updated Java-enabled web browser. We recommend the following:
 - Internet Explorer 7.0 or higher, Chrome, Firefox, or Safari 4 or higher
- Verify physical connectivity by checking for solid link lights on the device. If you do not get a solid link light, try using a different cable or connect to a different port on the device if possible. If the computer is turned off, the link light may not be on.
- Disable any internet security software running on the computer. Software firewalls such as Zone Alarm, Black Ice, Sygate, Norton Personal Firewall, and Windows® firewall may block access to the configuration pages. Check the help files included with your firewall software for more information on disabling or configuring it.
- Configure your Internet settings:
 - Go to Start > Settings > Control Panel. Double-click the Internet Options Icon. From the Security tab, click the button to restore the settings to their defaults.
 - Click the Connection tab and set the dial-up option to Never Dial a Connection. Click the LAN Settings button. Make sure nothing is checked. Click OK.
 - Go to the Advanced tab and click the button to restore these settings to their defaults. Click OK three times.
 - Close your web browser (if open) and open it.
- Access the web management. Open your web browser and enter the IP address of your D-Link access point in the address bar. This should open the login page for your the web management.
- If you still cannot access the configuration, unplug the power to the access point for 10 seconds and plug back in. Wait about 30 seconds and try accessing the configuration. If you have multiple computers, try connecting using a different computer.

What can I do if I forgot my password?

If you forgot your password, you must reset your access point. Unfortunately, this process will change all your settings back to the factory defaults.

To reset the access point, locate the reset button (hole) on the rear panel of the unit. With the access point powered on, use a paperclip to hold the button down for 10 seconds. Release the button and the access point will go through its reboot process. Wait about 30 seconds to access the access point. The default IP address is 192.168.0.50. When logging in, the username is admin and leave the password box empty.

How to check your IP address?

After you install your network adapter, by default, the TCP/IP settings should be set to obtain an IP address from a DHCP server (i.e. wireless router) automatically. To verify your IP address, please follow the steps below.

Click on Start > Run. In the run box type cmd and click OK.

At the prompt, type ipconfig and press Enter.

This will display the IP address, subnet mask, and the default gateway of your adapter.

If the address is 0.0.0.0, check your adapter installation, security settings, and the settings on your router. Some firewall software programs may block a DHCP request on newly installed adapters.

If you are connecting to a wireless network at a hotspot (e.g. hotel, coffee shop, airport), please contact an employee or administrator to verify their wireless network settings.

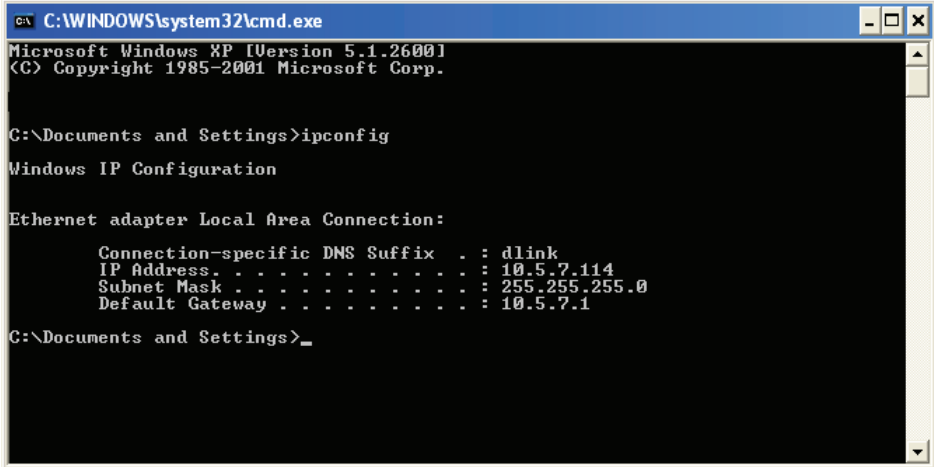

```
C:\WINDOWS\system32\cmd.exe
Microsoft Windows XP [Version 5.1.2600]
(C) Copyright 1985-2001 Microsoft Corp.

C:\Documents and Settings>ipconfig

Windows IP Configuration

Ethernet adapter Local Area Connection:

    Connection-specific DNS Suffix  . : dlink
    IP Address . . . . . : 10.5.7.114
    Subnet Mask . . . . . : 255.255.255.0
    Default Gateway . . . . . : 10.5.7.1

C:\Documents and Settings>_
```

How to statically assign an IP address?

If you are not using a DHCP capable gateway/router, or you need to assign a static IP address, please follow the steps below:

Step 1:

Windows® 2000: Click on Start > Settings > Control Panel > Network Connections

Windows XP: Click on Start > Control Panel > Network Connections

Windows Vista®: Click on Start > Control Panel > Network and Internet > Network and Sharing Center > Manage network connections

Step 2:

Right-click on the Local Area Connection which represents your network adapter and select Properties.

Step 3:

Highlight Internet Protocol (TCP/IP) and click Properties.

Step 4:

Click Use the following IP address and enter an IP address that is on the same subnet as your network or the LAN IP address on your router.

Example: If the router's LAN IP address is 192.168.0.1, make your IP address 192.168.0.X where X is a number between 2 and 99. Make sure that the number you choose is not in use on the network. Set Default Gateway the same as the LAN IP address of your router (192.168.0.1).

Set Primary DNS the same as the LAN IP address of your router (192.168.0.1). The Secondary DNS is not needed or you may enter a DNS server from your ISP.

Step 5:

Click OK twice to save your settings.

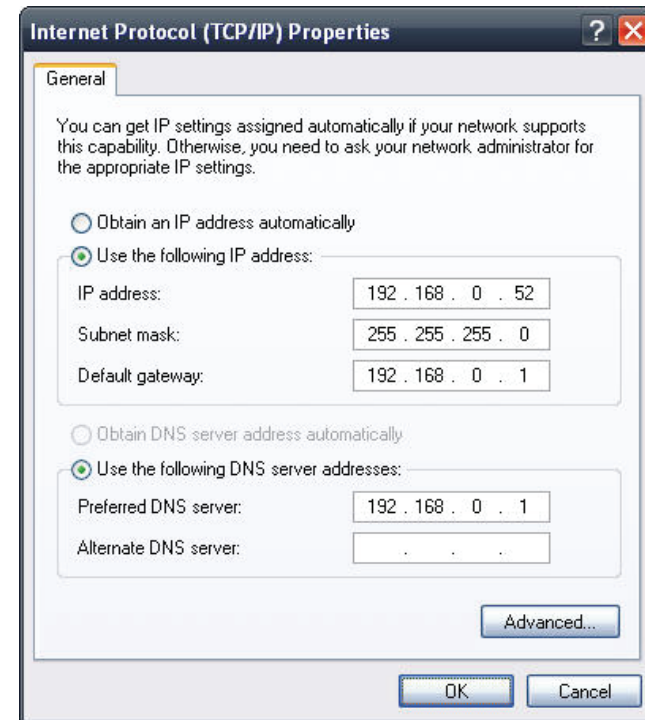

Technical Specifications

Standards

- IEEE 802.11ac
- IEEE 802.11n
- IEEE 802.11g
- IEEE 802.11a
- IEEE 802.3
- IEEE 802.3u
- IEEE 802.3ab
- IEEE 802.3af
- IEEE 802.3x

Network Management

- Web Browser interface (HTTP, Secure HTTP (HTTPS))
- Central WiFiManager
- SNMP Support (Private MIB)
- Command Line Interface (Telnet, Secure SSH Telnet)

Security

- WPA™ Personal/Enterprise
- WPA2™ Personal/Enterprise
- WEP™ 64-/128-bit

Wireless Frequency Range

- 2.4 to 2.4835 GHz and 5.15 to 5.85 GHz**

Operating Voltage

- 48V DC +/- 10% for PoE or 12V/1A

Antenna Type

- 2x Detachable 3 dBi Omni antennas @2.4GHz
- 2x Detachable 4 dBi Omni antennas @5GHz

LEDs

- Power/Status

Temperature

- Operating: 0°C to 40°C
- Storing: -20°C to 65°C

Humidity

- Operating: 10%~90% (non-condensing)
- Storing: 5%~95% (non-condensing)

Certifications

- FCC Class B
- CE
- UL
- IC
- C-Tick
- CSA
- Wi-Fi

Dimensions

- L = 170 mm
- W = 170 mm
- H = 28 mm

Antenna Pattern

