

Web UI Reference Guide

Product Model: DGS-1510 Series

Gigabit Ethernet SmartPro Switch

Release 1.10

Information in this document is subject to change without notice. Reproduction of this document in any manner, without the written permission of the D-Link Corporation, is strictly forbidden.

Trademarks used in this text: D-Link and the D-Link logo are trademarks of the D-Link Corporation; Microsoft and Windows are registered trademarks of the Microsoft Corporation.

Other trademarks and trade names may be used in this document to refer to either as the entities claiming the marks and the names or their products. D-Link Corporation disclaims any proprietary interest in trademarks and trade names other than its own.

© 2014 D-Link Corporation. All rights reserved.

April, 2014

Table of Contents

1. Introduction	1
Audience	1
Other Documentation	1
Conventions	1
Notes, Notices, and Cautions	1
2. Web-based Switch Configuration	3
Management Options	3
Connecting using the Web User Interface	3
Logging onto the Web Manager	3
Smart Wizard	4
Web User Interface (Web UI)	8
Areas of the User Interface	8
3. System	9
Device Information	9
System Information Settings	9
Peripheral Settings	10
Port Configuration	11
Port Settings	11
Port Status	12
Port Auto Negotiation	13
Error Disable Settings	14
Jumbo Frame	15
PoE (DGS-1510-28P Only)	16
PoE System	16
PoE Status	17
PoE Configuration	18
PoE Statistics	19
PoE Measurement	20
PoE LLDP Classification	21
System Log	22
System Log Settings	22
System Log Discriminator Settings	23
System Log Server Settings	24
System Log	25
System Attack Log	25
Time and SNTP	26
Clock Settings	26
Time Zone Settings	26
SNTP Settings	28
Time Range	29
4. Management	31
User Account Settings	31
Password Encryption	32
Login Method	33

SNMP	34
SNMP Global Settings	35
SNMP Linkchange Trap Settings	36
SNMP View Table Settings.....	37
SNMP Community Table Settings	38
SNMP Group Table Settings	39
SNMP Engine ID Local Settings	41
SNMP User Table Settings.....	41
SNMP Host Table Settings	42
RMON	43
RMON Global Settings	43
RMON Statistics Settings	44
RMON History Settings.....	45
RMON Alarm Settings	45
RMON Event Settings.....	46
Telnet/Web.....	47
Session Timeout	48
DHCP	49
Service DHCP.....	49
DHCP Class Settings.....	49
DHCP Relay.....	51
DHCPv6 Relay.....	56
DHCP Auto Configuration.....	58
DNS.....	58
DNS Global Settings.....	59
DNS Name Server Settings	60
DNS Host Settings.....	60
IP Source Interface	61
File System	61
Physical Stacking.....	63
Virtual Stacking (SIM)	68
Single IP Settings	70
Topology	71
Firmware Upgrade	78
Configuration File Backup/Restore	79
Upload Log File.....	79
D-Link Discovery Protocol.....	80
5. Layer 2 Features.....	82
FDB	82
Static FDB.....	82
MAC Address Table Settings.....	83
MAC Address Table.....	84
MAC Notification	85
VLAN.....	87
802.1Q VLAN.....	87
GVRP.....	88
Asymmetric VLAN.....	91
VLAN Interface	92

Auto Surveillance VLAN	95
Voice VLAN.....	98
Spanning Tree	101
STP Global Settings	103
STP Port Settings	105
MST Configuration Identification	106
STP Instance	107
MSTP Port Information	108
Loopback Detection	108
Link Aggregation	110
L2 Multicast Control	112
IGMP Snooping	113
MLD Snooping.....	118
Multicast Filtering.....	125
LLDP	126
LLDP Global Settings	126
LLDP Port Settings	127
LLDP Management Address List.....	129
LLDP Basic TLVs Settings.....	129
LLDP Dot1 TLVs Settings.....	130
LLDP Dot3 TLVs Settings.....	131
LLDP-MED Port Settings	132
LLDP Statistics Information	133
LLDP Local Port Information.....	134
LLDP Neighbor Port Information	136
6. Layer 3 Features.....	137
ARP	137
ARP Aging Time	137
Static ARP.....	137
Proxy ARP	138
ARP Table.....	139
Gratuitous ARP	139
IPv4 Interface.....	140
IPv4 Static/Default Route.....	142
IPv4 Route Table	143
IPv6 Interface.....	144
IPv6 Neighbor	146
IPv6 Static/Default Route.....	147
IPv6 Route Table	147
7. Quality of Service (QoS).....	149
Basic Settings	149
Port Default CoS.....	149
Port Scheduler Method.....	149
Queue Settings	151
CoS to Queue Mapping	152
Port Rate Limiting	152
Queue Rate Limiting	153
Advanced Settings	155

DSCP Mutation Map	155
Port Trust State and Mutation Binding.....	156
DSCP CoS Mapping	156
CoS Color Mapping	157
DSCP Color Mapping	158
Class Map	159
Aggregate Policer	161
Policy Map	164
Policy Binding	167
8. Access Control List (ACL).....	169
ACL Configuration Wizard	169
ACL Access List.....	202
Standard IP ACL.....	203
Extended IP ACL	206
Standard IPv6 ACL	225
Extended IPv6 ACL	229
Extended MAC ACL.....	241
Extended Expert ACL	245
ACL Interface Access Group	270
ACL VLAN Access Map	271
ACL VLAN Filter.....	273
9. Security	275
Port Security.....	275
Port Security Global Settings.....	275
Port Security Port Settings.....	276
Port Security Address Entries.....	277
802.1X.....	278
802.1X Global Settings.....	283
802.1X Port Settings.....	283
Authentication Session Information	285
Authenticator Statistics	285
Authenticator Session Statistics	286
Authenticator Diagnostics	286
AAA.....	287
AAA Global Settings	287
Application Authentication Settings	287
Application Accounting Settings	288
Authentication Settings.....	289
Accounting Settings	291
RADIUS.....	292
RADIUS Global Settings.....	292
RADIUS Server Settings.....	293
RADIUS Group Server Settings	294
RADIUS Statistic.....	295
TACACS.....	296
TACACS Server Settings.....	296
TACACS Group Server Settings	296
TACACS Statistic.....	297

IMPB	298
IPv4	298
IPv6	311
DHCP Server Screening	317
DHCP Server Screening Global Settings	317
DHCP Server Screening Port Settings	318
ARP Spoofing Prevention	319
BPDU Attack Protection	319
MAC Authentication	321
Web-based Access Control	322
Web Authentication	325
WAC Port Settings	326
WAC Customize Page	326
Japanese Web-based Access Control	327
JWAC Global Settings	327
JWAC Port Settings	330
JWAC Customize Page Language	331
JWAC Customize Page	331
Network Access Authentication	332
Guest VLAN	332
Network Access Authentication Global Settings	333
Network Access Authentication Port Settings	335
Network Access Authentication Sessions Information	336
Safeguard Engine	337
Safeguard Engine Settings	338
CPU Protect Counters	339
CPU Protect Sub-Interface	340
CPU Protect Type	340
Trusted Host	341
Traffic Segmentation Settings	342
Storm Control	342
DoS Attack Prevention Settings	345
SSH	346
SSH Global Settings	347
Host Key	347
SSH Server Connection	348
SSH User Settings	348
SSL	349
SSL Global Settings	350
Crypto PKI Trustpoint	351
SSL Service Policy	352
10. OAM	353
Cable Diagnostics	353
DDM	353
DDM Settings	354
DDM Temperature Threshold Settings	354
DDM Voltage Threshold Settings	355
DDM Bias Current Threshold Settings	356

DDM TX Power Threshold Settings.....	356
DDM RX Power Threshold Settings	357
DDM Status Table	358
11. Monitoring.....	359
Utilization.....	359
Port Utilization.....	359
Statistics.....	360
Port	360
Port Counters.....	361
Counters	363
Mirror Settings.....	365
Device Environment.....	367
12. Green	368
Power Saving	368
EEE	369
13. Save and Tools.....	371
Save Configuration	371
Firmware Upgrade & Backup.....	371
Firmware Upgrade from HTTP	371
Firmware Upgrade from TFTP.....	372
Firmware Backup to HTTP	372
Firmware Backup to TFTP.....	373
Configuration Restore & Backup	373
Configuration Restore from HTTP	373
Configuration Restore from TFTP	374
Configuration Backup to HTTP.....	375
Configuration Backup to TFTP	375
Log Backup	376
Log Backup to HTTP	376
Log Backup to TFTP.....	376
Ping.....	377
Trace Route	379
Language Management.....	381
Reset.....	381
Reboot System	382
Appendix A - System Log Entries	383
Appendix B - Trap Entries	407
Appendix C - RADIUS Attributes Assignment	418
Appendix D - IETF RADIUS Attributes Support	421

1. Introduction

This manual's command descriptions are based on the software release 1.10. The commands listed here are the subset of commands that are supported by the DGS-1510 Series SmartPro switch.

Audience

This reference manual is intended for network administrators and other IT networking professionals responsible for managing the switch by using the Web User Interface (Web UI). The Web UI is the secondary management interface to the DGS-1510 Series switch, which will be generally be referred to simply as “the Switch” within this manual. This manual is written in a way that assumes that you already have the experience and knowledge of Ethernet and modern networking principles for Local Area Networks.

Other Documentation

The documents below are a further source of information in regards to configuring and troubleshooting the switch. All the documents are available either from the CD, bundled with this switch, or from the D-Link website. Other documents related to this switch are:

- *DGS-1510 Series Gigabit Ethernet SmartPro Switch Hardware Installation Guide*
- *DGS-1510 Series Gigabit Ethernet SmartPro Switch CLI Reference Guide*

Conventions

Convention	Description
Boldface Font	Indicates a button, a toolbar icon, menu, or menu item. For example: Open the File menu and choose Cancel . Used for emphasis. May also indicate system messages or prompts appearing on screen. For example: You have mail . Bold font is also used to represent filenames, program names and commands. For example: use the copy command.
Initial capital letter	Indicates a window name. Names of keys on the keyboard have initial capitals. For example: Click Enter.
Menu Name > Menu Option	Indicates the menu structure. Device > Port > Port Properties means the Port Properties menu option under the Port menu option that is located under the Device menu.
<i>Blue Courier Font</i>	This convention is used to represent an example of a screen console display including example entries of CLI command input with the corresponding output.

Notes, Notices, and Cautions

Below are examples of the three types of indicators used in this manual. When administering your switch using the information in this document, you should pay special attention to these indicators. Each example below provides an explanatory remark regarding each type of indicator.



NOTE: A note indicates important information that helps you make better use of your device.



NOTICE: A notice indicates either potential damage to hardware or loss of data and tells you how to avoid the problem.



CAUTION: A caution indicates a potential for property damage, personal injury, or death.

2. Web-based Switch Configuration

Management Options

Connecting using the Web User Interface

Logging onto the Web Manager

Smart Wizard

Web User Interface (Web UI)

Management Options

The Switch provides multiple access platforms that can be used to configure, manage and monitor networking features available on the Switch. Currently there are three management platforms available and they are described below.

The Command Line Interface (CLI) through the RJ45 Console port or remote Telnet

The Switch can be managed, out-of-band, by using the console port on the front panel of the Switch. Alternatively, the Switch can also be managed, in-band, by using a Telnet connection to any of the LAN ports on the Switch. The command line interface provides complete access to all switch management features.

SNMP-based Management

The Switch can be managed with an SNMP-compatible console program. The Switch supports SNMP version 1.0, version 2.0 and version 3.0. The SNMP agent decodes the incoming SNMP messages and responds to requests with MIB objects stored in the database. The SNMP agent updates the MIB objects to generate statistics and counters.

Web-based Management Interface

After successfully installing the Switch, the user can configure the Switch, monitor the LED panel, and display statistics graphically using a Web browser, such as Microsoft® Internet Explorer, Mozilla Firefox, Safari, or Google Chrome.

Connecting using the Web User Interface

Most software functions of the DGS-1510 Series switches can be managed, configured and monitored via the embedded web-based (HTML) interface. Manage the Switch from remote stations anywhere on the network through a standard web browser. The web browser acts as a universal access tool and can communicate directly with the Switch using the HTTP or HTTPS protocol.



NOTE: The Command Line Interface (CLI) provides the functionality of managing, configuring, and monitoring **all** of the software features that are available on the Switch.

Logging onto the Web Manager

To access the Web User Interface, simply open a standard web browser on the management PC and enter the Switch's default IP address into the address bar of the browser and press the **Enter** key.



NOTE: The default IP address of this switch is **10.90.90.90**, with a subnet mask of **255.0.0.0**.



Figure 2-1 Displays entering the IP address in Internet Explorer

This will open the user authentication window, as seen below.

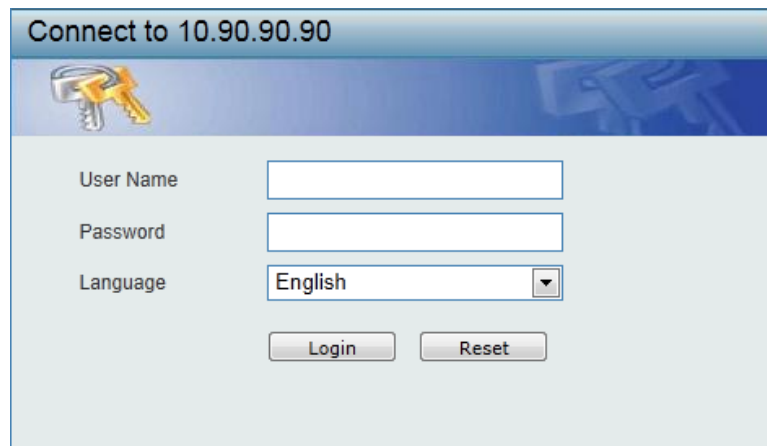

Figure 2-2 User Authentication window

By default, there is no username or password configured on this switch. When connecting to the Web UI for the first time simply leave the **User Name** and **Password** fields blank and click the **Login** button.

Smart Wizard

After a successfully connecting to the Web User Interface for the first time, the Smart Wizard embedded Web utility will be launched. This wizard will guide the user through basic configuration steps that is essential for first time connection to the Switch.

Step 1 – System IP Information

In this window, the user can configure the IP address assignment method, the static IP address, Netmask and Gateway address.

Figure 2-3 System IP Information window

The fields that can be configured are described below:

Parameter	Description
Static	Select this option to manually configure and use IP address settings on this switch.
DHCP	Select this option to obtain IP address settings from a DHCP server.
IP Address	Enter the IP address of the Switch here.
Netmask	Select the Netmask option here.
Gateway	Enter the default gateway IP address here.

Tick the **Ignore the wizard next time** option to skip the Smart Wizard on the next login.

Click the **Exit** button to discard the changes made, exit the Smart Wizard, and continue to the Web UI.

Click the **Next** button to accept the changes made and continue to the next step.

Step 2 – SNMP Settings

In this window, the user can enable or disable the SNMP function.

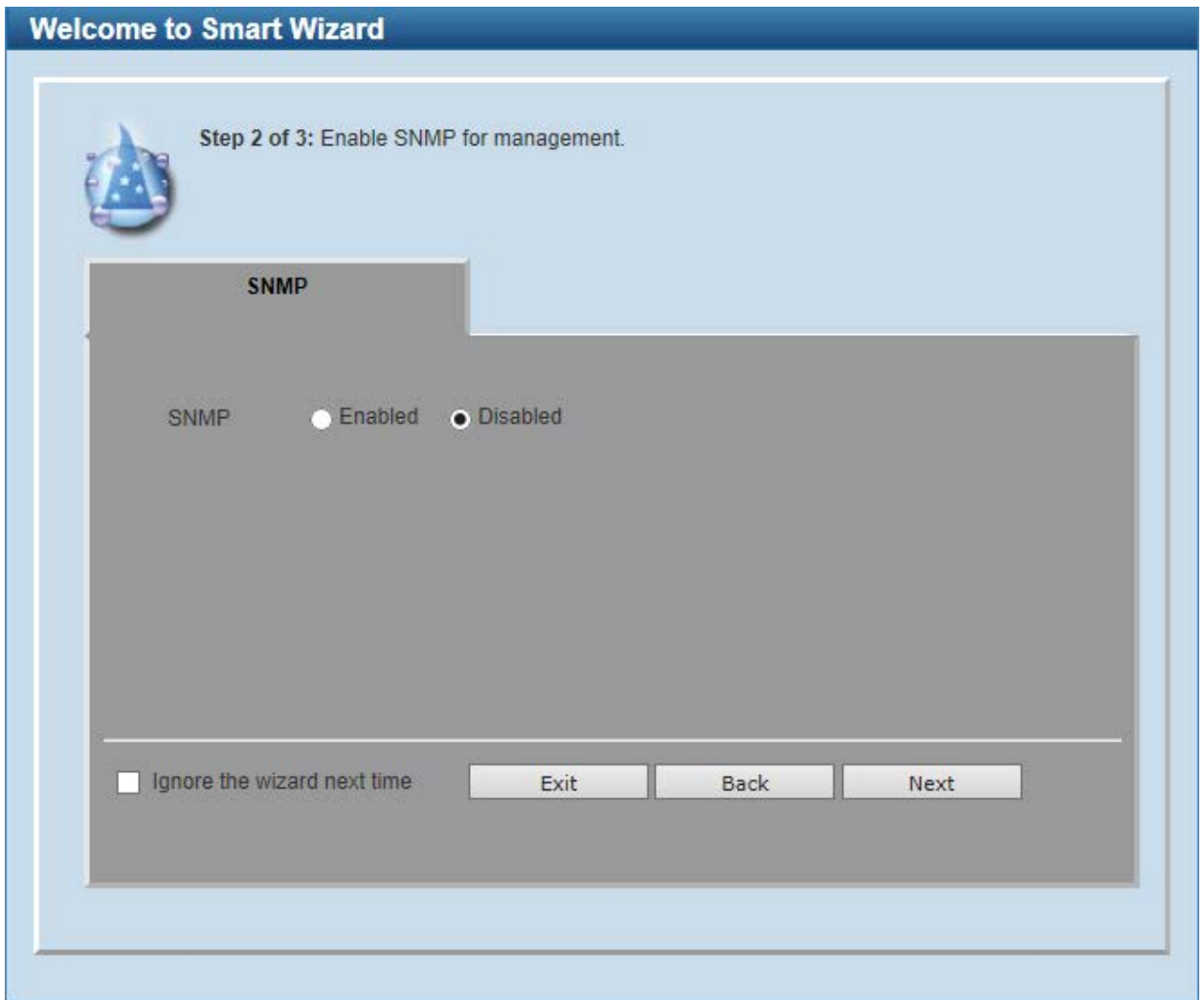

Figure 2-4 SNMP window

The fields that can be configured are described below:

Parameter	Description
SNMP	Select the Enabled option to enable the SNMP function. Select the Disabled option to disable the SNMP function.

Tick the **Ignore the wizard next time** option to skip the Smart Wizard on the next login.

Click the **Exit** button to discard the changes made, exit the Smart Wizard, and continue to the Web UI.

Click the **Back** button to discard the changes made and return to the previous step.

Click the **Apply** button to accept the changes made and continue to the Web UI.

Step 3 – User Accounts Settings

In this window, the user can configure the user account settings.

Welcome to Smart Wizard

Step 3 of 3: Configure User Account for management.

User Accounts Settings

User Name: 32 chars

Privilege (1-15):

Password Type: None

Password:

Ignore the wizard next time

Exit Back Apply

Figure 2-5 SNMP window

The fields that can be configured are described below:

Parameter	Description
User Name	Enter the username for the new user account here.
Privilege	Enter the privilege level for the user account here. This value must be between 1 and 15. The higher this value is, the more privileges will be assigned to the user account.
Password Type	Select the password type here. Options to choose from are None , Plain Text , and Encrypted .
Password	After selecting either Plain Text or Encrypted as the Password Type , this field will be available. Enter the password for the user account here.

Tick the **Ignore the wizard next time** option to skip the Smart Wizard on the next login.

Click the **Exit** button to discard the changes made, exit the Smart Wizard, and continue to the Web UI.

Click the **Back** button to discard the changes made and return to the previous step.

Click the **Apply** button to accept the changes made and continue to the Web UI.

Web User Interface (Web UI)

By clicking the **Exit** button in the Smart Wizard, you will enter the Web-based Management interface.

Areas of the User Interface

The figure below shows the user interface. Three distinct areas that divide the user interface, as described in the table.

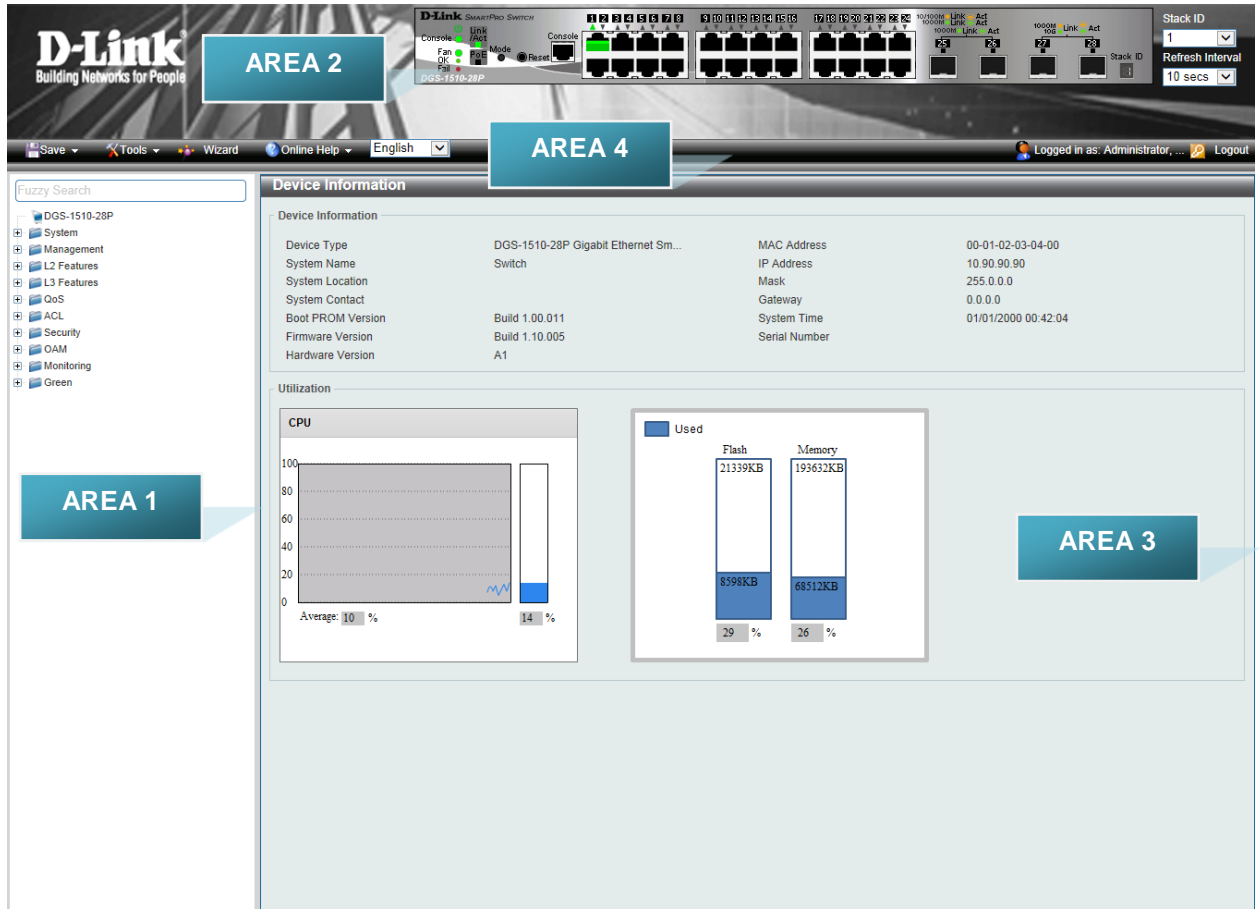

Figure 2-6 Main Web UI window

Area Number	Description
AREA 1	Select the folder or window to display. Open folders and click the hyperlinked window buttons and subfolders contained within them to display windows.
AREA 2	Presents a graphical near real-time image of the front panel of the Switch. This area displays the Switch's ports and expansion modules and shows port activity, depending on the specified mode. Some management functions, including port monitoring are accessible here. Click the D-Link logo to go to the D-Link Website.
AREA 3	Presents Switch status based on user selection and the entry of configuration data. In addition, hyperlinks are offered for many Switch features to enable quick configuration.
AREA 4	Presents a toolbar used to access function like Save , Tools , the Wizard , Online Help , and Language preference.

3. System

[Device Information](#)
[System Information Settings](#)
[Peripheral Settings](#)
[Port Configuration](#)
[PoE \(DGS-1510-28P Only\)](#)
[System Log](#)
[Time and SNTP](#)
[Time Range](#)

Device Information

In this window, the Device Information, CPU, and Used status are displayed. It appears automatically when you log in the Switch. To return to the Device Information window after viewing other windows, click the **DGS-1510-28P** link.

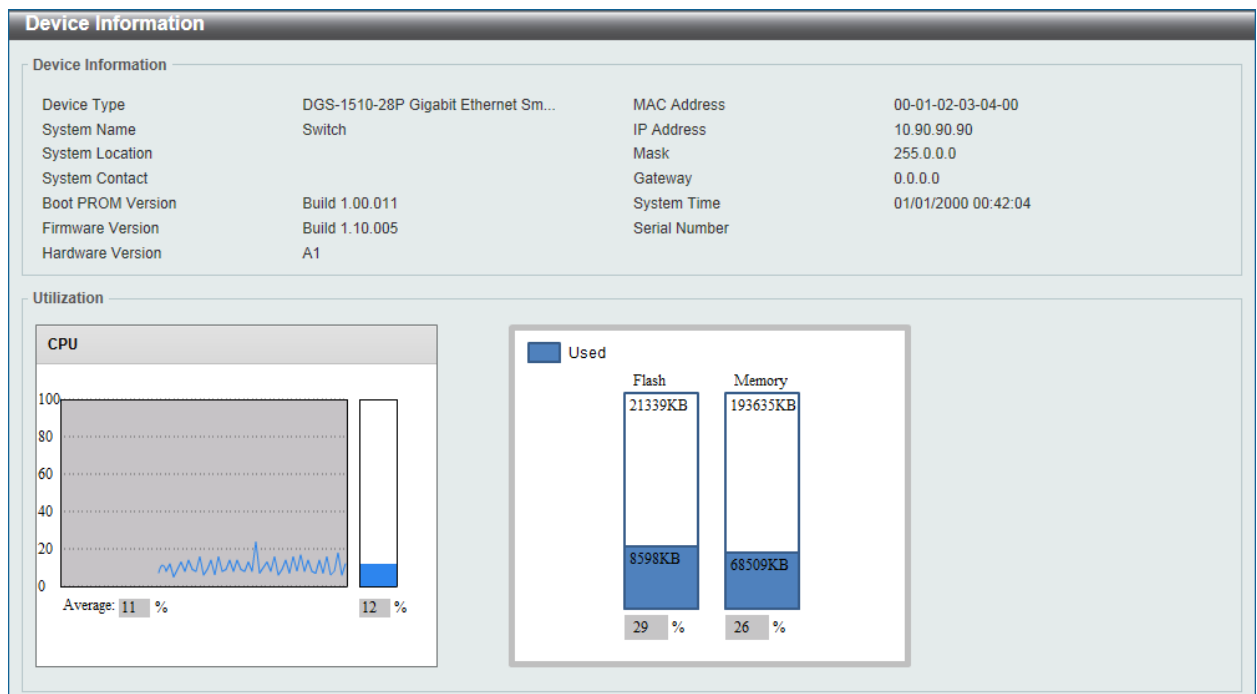

Figure 3-1 Device Information window

System Information Settings

The user can enter a System Name, System Location, and System Contact to aid in defining the Switch. To view the following window, click **System > System Information Settings**, as shown below:

Figure 3-2 System Information Settings window

The fields that can be configured are described below:

Parameter	Description
System Name	Enter a system name for the Switch, if so desired. This name will identify it in the Switch network.
System Location	Enter the location of the Switch, if so desired. This string can be up to 255 characters long.
System Contact	Enter a contact name for the Switch, if so desired. This string can be up to 255 characters long.

Click the **Apply** button to accept the changes made.

Peripheral Settings

This window is used to configure the environment trap settings and environment temperature threshold settings.

To view the following window, click **System > Peripheral Settings**, as shown below:

Figure 3-3 Peripheral Settings window

The fields that can be configured are described below:

Parameter	Description
Fan Trap	Click to enable or disable the fan trap state for waning fan event (fan failed or fan recover).
Power Trap	Click to enable or disable the power trap state for waning power event (power failed or power recover).
Temperature Trap	Click to enable or disable the temperature trap state for waning temperature event (temperature exceeds the thresholds or temperature recover).

Unit	Select the switch unit that will be used for this configuration here.
Thermal	Select the thermal sensor ID.
High Threshold	Enter the high threshold value of the warning temperature setting. The range is from -100 to 200 Celsius degree. Tick the Default check box to return to the default value.
Low Threshold	Enter the low threshold value of the warning temperature setting. The range is from -100 to 200 Celsius degree. Tick the Default check box to return to the default value.

Click the **Apply** button to accept the changes made.

Port Configuration

Port Settings

This window is used to view and configure the Switch's port settings.

To view the following window, click **System > Port Configuration > Port Settings**, as shown below:

The screenshot shows the 'Port Settings' window. At the top, there are configuration fields for 'Unit' (1), 'From Port' (eth1/0/1), 'To Port' (eth1/0/1), 'State' (Enabled), 'MDIX' (Auto), 'Auto Downgrade' (Disabled), and 'Flow Control' (Off). Below these are fields for 'Duplex' (Auto), 'Speed' (Auto), 'Capability Advertised' (10M, 100M, 1000M), and 'Description' (64 chars). An 'Apply' button is located to the right of the description field.

Below the configuration fields is a table titled 'Unit 1 Settings' with the following data:

Port	Link Status	State	MDIX	Flow Control		Duplex	Speed	Auto Downgrade	Description
				Send	Receive				
eth1/0/1	Up	Enabled	Auto-MDIX	Off	Off	Auto-duplex	Auto-speed	Disabled	
eth1/0/2	Down	Enabled	Auto-MDIX	Off	Off	Auto-duplex	Auto-speed	Disabled	
eth1/0/3	Down	Enabled	Auto-MDIX	Off	Off	Auto-duplex	Auto-speed	Disabled	
eth1/0/4	Down	Enabled	Auto-MDIX	Off	Off	Auto-duplex	Auto-speed	Disabled	
eth1/0/5	Down	Enabled	Auto-MDIX	Off	Off	Auto-duplex	Auto-speed	Disabled	
eth1/0/6	Down	Enabled	Auto-MDIX	Off	Off	Auto-duplex	Auto-speed	Disabled	
eth1/0/7	Down	Enabled	Auto-MDIX	Off	Off	Auto-duplex	Auto-speed	Disabled	
eth1/0/8	Down	Enabled	Auto-MDIX	Off	Off	Auto-duplex	Auto-speed	Disabled	
eth1/0/9	Down	Enabled	Auto-MDIX	Off	Off	Auto-duplex	Auto-speed	Disabled	
eth1/0/10	Down	Enabled	Auto-MDIX	Off	Off	Auto-duplex	Auto-speed	Disabled	
eth1/0/11	Down	Enabled	Auto-MDIX	Off	Off	Auto-duplex	Auto-speed	Disabled	
eth1/0/12	Down	Enabled	Auto-MDIX	Off	Off	Auto-duplex	Auto-speed	Disabled	
eth1/0/13	Down	Enabled	Auto-MDIX	Off	Off	Auto-duplex	Auto-speed	Disabled	
eth1/0/14	Down	Enabled	Auto-MDIX	Off	Off	Auto-duplex	Auto-speed	Disabled	
eth1/0/15	Down	Enabled	Auto-MDIX	Off	Off	Auto-duplex	Auto-speed	Disabled	
eth1/0/16	Down	Enabled	Auto-MDIX	Off	Off	Auto-duplex	Auto-speed	Disabled	
eth1/0/17	Down	Enabled	Auto-MDIX	Off	Off	Auto-duplex	Auto-speed	Disabled	
eth1/0/18	Down	Enabled	Auto-MDIX	Off	Off	Auto-duplex	Auto-speed	Disabled	
eth1/0/19	Down	Enabled	Auto-MDIX	Off	Off	Auto-duplex	Auto-speed	Disabled	
eth1/0/20	Down	Enabled	Auto-MDIX	Off	Off	Auto-duplex	Auto-speed	Disabled	

Figure 3-4 Port Settings window

The fields that can be configured are described below:

Parameter	Description
Unit	Select the switch unit that will be used for this configuration here.

From Port / To Port	Select the appropriate port range used for the configuration here.
State	Select this option to enable or disable the physical port here.
MDIX	Select the Medium Dependent Interface Crossover (MDIX) option here. Options to choose from are Auto , Normal , and Cross . Auto - Select this option for auto-sensing of the optimal type of cabling. Normal - Select this option for normal cabling. If this option is selected, the port is in the MDIX mode and can be connected to a PC's NIC using a straight-through cable or a port (in the MDIX mode) on another switch through a cross-over cable. Cross - Select this option for cross cabling. If this option is selected, the port is in the MDI mode and can be connected to a port (in the MDIX mode) on another switch through a straight cable.
Auto Downgrade	Select this option to enable or disable automatically downgrading advertised speed in case a link cannot be established at the available speed.
Flow Control	Select to either turn flow control On or Off here. Ports configured for full-duplex use 802.3x flow control, half-duplex ports use back-pressure flow control, and Auto ports use an automatic selection of the two.
Duplex	Select the duplex mode used here. Options to choose from are Auto , Half , and Full .
Speed	Select the port speed option here. This option will manually force the connected on the selected port to only connect at the speed specified here. Options to choose from are Auto , 10M , 100M , 1000M , 1000M Master , 1000M Slave , and 10G . The Switch allows users to configure two types of gigabit connections; 1000M Master and 1000M Slave which refer to connections running a 1000BASE-T cable for connection between the Switch port and another device capable of a gigabit connection. The master setting (1000M Master) will allow the port to advertise capabilities related to duplex, speed and physical layer type. The master setting will also determine the master and slave relationship between the two connected physical layers. This relationship is necessary for establishing the timing control between the two physical layers. The timing control is set on a master physical layer by a local source. The slave setting (1000M Slave) uses loop timing, where the timing comes from a data stream received from the master. If one connection is set for 1000M Master, the other side of the connection must be set for 1000M Slave. Any other configuration will result in a link down status for both ports.
Capability Advertised	When the Speed is set to Auto , these capabilities are advertised during auto-negotiation.
Description	Enter a 64 characters description for the corresponding port here.

Click the **Apply** button to accept the changes made.

Port Status

This window is used to view the Switch's physical port status and settings.

To view the following window, click **System > Port Configuration > Port Status**, as shown below:

Port	Status	MAC Address	VLAN	Flow Control Operator		Duplex	Speed	Type
				Send	Receive			
eth1/0/1	Connected	00-01-02-03-04-01	1	Off	Off	Auto-Full	Auto-1000M	1000BASE-T
eth1/0/2	Not-Connected	00-01-02-03-04-02	1	Off	Off	Auto	Auto	1000BASE-T
eth1/0/3	Not-Connected	00-01-02-03-04-03	1	Off	Off	Auto	Auto	1000BASE-T
eth1/0/4	Not-Connected	00-01-02-03-04-04	1	Off	Off	Auto	Auto	1000BASE-T
eth1/0/5	Not-Connected	00-01-02-03-04-05	1	Off	Off	Auto	Auto	1000BASE-T
eth1/0/6	Not-Connected	00-01-02-03-04-06	1	Off	Off	Auto	Auto	1000BASE-T
eth1/0/7	Not-Connected	00-01-02-03-04-07	1	Off	Off	Auto	Auto	1000BASE-T
eth1/0/8	Not-Connected	00-01-02-03-04-08	1	Off	Off	Auto	Auto	1000BASE-T
eth1/0/9	Not-Connected	00-01-02-03-04-09	1	Off	Off	Auto	Auto	1000BASE-T
eth1/0/10	Not-Connected	00-01-02-03-04-0A	1	Off	Off	Auto	Auto	1000BASE-T
eth1/0/11	Not-Connected	00-01-02-03-04-0B	1	Off	Off	Auto	Auto	1000BASE-T
eth1/0/12	Not-Connected	00-01-02-03-04-0C	1	Off	Off	Auto	Auto	1000BASE-T
eth1/0/13	Not-Connected	00-01-02-03-04-0D	1	Off	Off	Auto	Auto	1000BASE-T
eth1/0/14	Not-Connected	00-01-02-03-04-0E	1	Off	Off	Auto	Auto	1000BASE-T
eth1/0/15	Not-Connected	00-01-02-03-04-0F	1	Off	Off	Auto	Auto	1000BASE-T
eth1/0/16	Not-Connected	00-01-02-03-04-10	1	Off	Off	Auto	Auto	1000BASE-T
eth1/0/17	Not-Connected	00-01-02-03-04-11	1	Off	Off	Auto	Auto	1000BASE-T
eth1/0/18	Not-Connected	00-01-02-03-04-12	1	Off	Off	Auto	Auto	1000BASE-T
eth1/0/19	Not-Connected	00-01-02-03-04-13	1	Off	Off	Auto	Auto	1000BASE-T
eth1/0/20	Not-Connected	00-01-02-03-04-14	1	Off	Off	Auto	Auto	1000BASE-T
eth1/0/21	Not-Connected	00-01-02-03-04-15	1	Off	Off	Auto	Auto	1000BASE-T

Figure 3-5 Port Status window

The fields that can be configured are described below:

Parameter	Description
Unit	Select the switch unit that will be used for this configuration here.

Port Auto Negotiation

This window is used to view detailed port auto-negotiation information.

To view the following window, click **System > Port Configuration > Port Auto Negotiation**, as shown below:

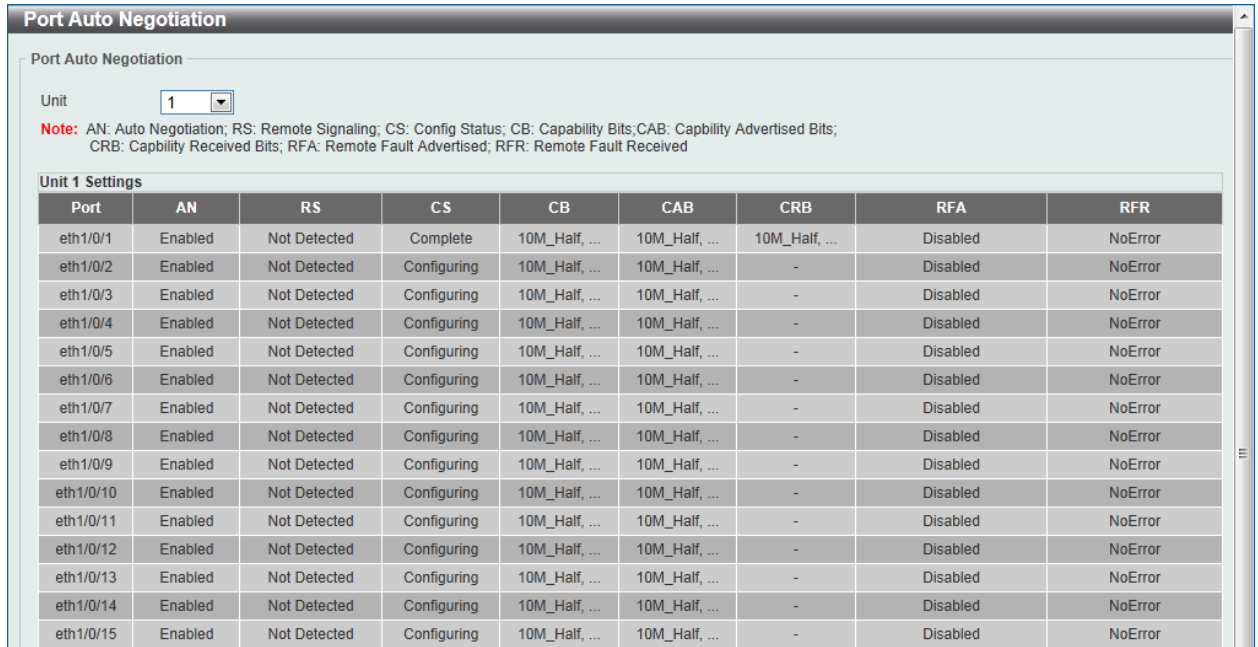

Figure 3-6 Port Auto Negotiation window

The fields that can be configured are described below:

Parameter	Description
Unit	Select the switch unit that will be used for this configuration here.

Error Disable Settings

This window is used to configure the sending of SNMP notifications for error disable state.

To view the following window, click **System > Port Configuration > Error Disable Settings**, as shown below:

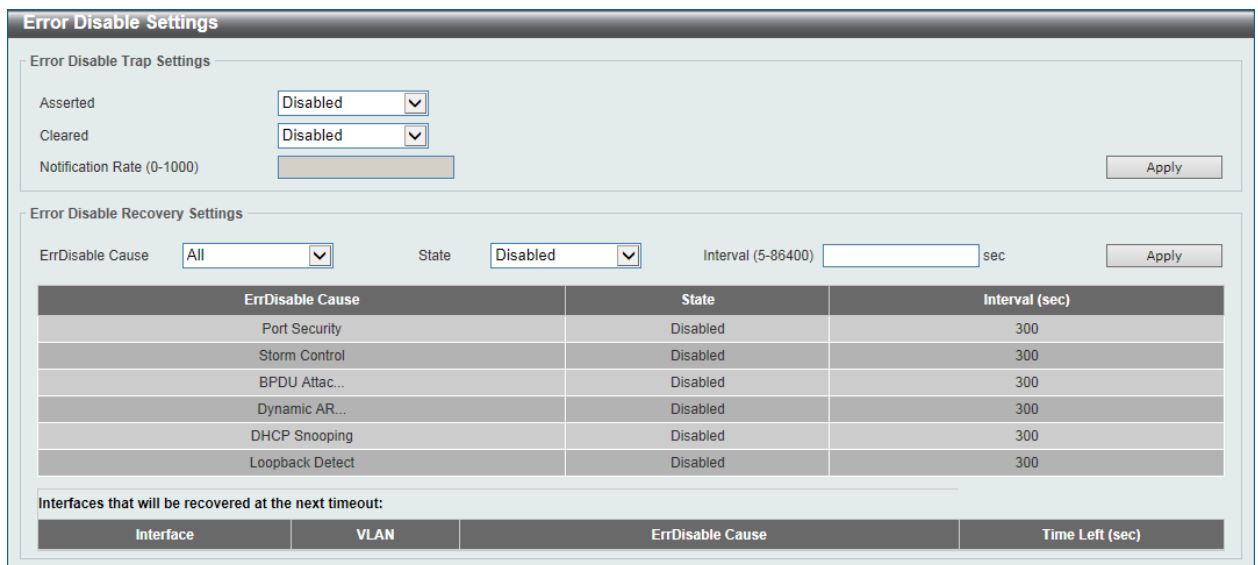

Figure 3-7 Error Disable Settings window

The fields that can be configured for **Error Disable Trap Settings** are described below:

Parameter	Description
Asserted	Select this option to enable or disable the notifications when entering into the error disabled state.
Cleared	Select this option to enable or disable the notifications when exiting from the error disabled state.
Notification Rate	Enter the number of traps per minute. The packets that exceed the rate will be dropped. The value is between 0 and 1000.

Click the **Apply** button to accept the changes made.

The fields that can be configured for **Error Disable Recovery Settings** are described below:

Parameter	Description
ErrDisable Cause	Select the error disable causes here. Options to choose from are All , Port Security , Storm Control , BPDU Attack Protection , Dynamic ARP Inspection , DHCP Snooping , and Loopback Detect .
State	Select this option to enable or disable the auto-recovery for an error port caused by the specified cause.
Interval	Enter the time between 5 and 86400 seconds to recover the port.

Click the **Apply** button to accept the changes made.

Jumbo Frame

This window is used to view and configure the Jumbo Frame size and settings. The Switch supports jumbo frames. Jumbo frames are Ethernet frames with more than 1,518 bytes of payload. The Switch supports jumbo frames with a maximum frame size of up to 9216 bytes.

To view the following window, click **System > Port Configuration > Jumbo Frame**, as shown below:

Jumbo Frame

Jumbo Frame

Unit: 1 From Port: eth1/0/1 To Port: eth1/0/1 Maximum Receive Frame Size (64-9216): 1536 bytes Apply

Unit 1 Settings

Port	Maximum Receive Frame Size (bytes)
eth1/0/1	1536
eth1/0/2	1536
eth1/0/3	1536
eth1/0/4	1536
eth1/0/5	1536
eth1/0/6	1536
eth1/0/7	1536
eth1/0/8	1536
eth1/0/9	1536
eth1/0/10	1536
eth1/0/11	1536
eth1/0/12	1536
eth1/0/13	1536
eth1/0/14	1536
eth1/0/15	1536

Figure 3-8 Jumbo Frame window

The fields that can be configured are described below:

Parameter	Description
Unit	Select the switch unit that will be used for this configuration here.
From Port / To Port	Select the appropriate port range used for the configuration here.
Maximum Receive Frame Size	Enter the maximum receive frame size value here. This value must be between 64 and 9216 bytes. By default, this value is 1536 bytes.

Click the **Apply** button to accept the changes made.

PoE (DGS-1510-28P Only)

The DGS-1510-28P switch supports Power over Ethernet (PoE) as defined by the IEEE 802.3af and 802.3at. All ports can support PoE up to 30W. Ports 1-24 can supply about 48 VDC power to Powered Devices (PDs) over Category 5 or Category 3 UTP Ethernet cables. The Switch follows the standard PSE (Power Sourcing Equipment) pinout *Alternative A*, whereby power is sent out over pins 1, 2, 3 and 6. The Switches work with all D-Link 802.3af capable devices.

The Switch includes the following PoE features:

- Auto-discovery recognizes the connection of a PD (Powered Device) and automatically sends power to it.
- The Auto-disable feature occurs under two conditions: firstly, if the total power consumption exceeds the system power limit; and secondly, if the per port power consumption exceeds the per port power limit.
- Active circuit protection automatically disables the port if there is a short. Other ports will remain active.

Based on 802.3af/at PDs receive power according to the following classification:

Class	Maximum power used by PD
0	12.95W
1	3.84W
2	6.49W
3	12.95W
4	25.5W

PSE provides power according to the following classification:

Class	Max power supplied by PSE
0	16.2W
1	4.2W
2	7.4W
3	16.2W
4	31.6W

PoE System

This window is used to configure the PoE system, and display the detailed power information and PoE chip parameters for PoE modules.

To view the following window, click **System > PoE > PoE System**, as shown below:

Unit	Delivered (W)	Power Budget (W)	Usage Threshold (%)	Policy Preempt	Trap State
1	0	193	99	Disabled	Disabled

Figure 3-9 PoE System window

The fields that can be configured are described below:

Parameter	Description
Unit	Select the switch unit that will be used for this configuration here.
Usage Threshold	Enter the usage threshold to generate a log and send the corresponding standard notification. The range is from 1 to 99 percent.
Policy Preempt	Select this option to enable or disable the disconnection of PD which in power-provisioned with lower priority in order to release the power to the new connected PD with higher priority under power shortage conditions.
Trap State	Select this option to enable or disable the sending of PoE notifications.

Click the **Apply** button to accept the changes made.

Click the **Show Detail** button to see the PoE system Parameters table at the bottom of the window.

After clicking the **Show Detail** button, the following table will appear.

Unit	Max Ports	Device ID	SW Version
1	24	E111	13

PoE Status

This window is used to configure the description, and display the PoE status of each port.

To view the following window, click **System > PoE > PoE Status**, as shown below:

PoE Status

PoE Status

Unit: 1 From Port: eth1/0/1 To Port: eth1/0/1 Description: 32 chars

Unit 1 Settings

Port	State	Class	Max (W)	Used (W)	Description
eth1/0/1	Searching	N/A	0.0	0.0	<input type="button" value="Delete Description"/>
eth1/0/2	Searching	N/A	0.0	0.0	<input type="button" value="Delete Description"/>
eth1/0/3	Searching	N/A	0.0	0.0	<input type="button" value="Delete Description"/>
eth1/0/4	Searching	N/A	0.0	0.0	<input type="button" value="Delete Description"/>
eth1/0/5	Searching	N/A	0.0	0.0	<input type="button" value="Delete Description"/>
eth1/0/6	Searching	N/A	0.0	0.0	<input type="button" value="Delete Description"/>
eth1/0/7	Searching	N/A	0.0	0.0	<input type="button" value="Delete Description"/>
eth1/0/8	Searching	N/A	0.0	0.0	<input type="button" value="Delete Description"/>
eth1/0/9	Searching	N/A	0.0	0.0	<input type="button" value="Delete Description"/>
eth1/0/10	Searching	N/A	0.0	0.0	<input type="button" value="Delete Description"/>
eth1/0/11	Searching	N/A	0.0	0.0	<input type="button" value="Delete Description"/>
eth1/0/12	Searching	N/A	0.0	0.0	<input type="button" value="Delete Description"/>
eth1/0/13	Searching	N/A	0.0	0.0	<input type="button" value="Delete Description"/>
eth1/0/14	Searching	N/A	0.0	0.0	<input type="button" value="Delete Description"/>
eth1/0/15	Searching	N/A	0.0	0.0	<input type="button" value="Delete Description"/>
eth1/0/16	Searching	N/A	0.0	0.0	<input type="button" value="Delete Description"/>
eth1/0/17	Searching	N/A	0.0	0.0	<input type="button" value="Delete Description"/>
eth1/0/18	Searching	N/A	0.0	0.0	<input type="button" value="Delete Description"/>
eth1/0/19	Searching	N/A	0.0	0.0	<input type="button" value="Delete Description"/>
eth1/0/20	Searching	N/A	0.0	0.0	<input type="button" value="Delete Description"/>
eth1/0/21	Searching	N/A	0.0	0.0	<input type="button" value="Delete Description"/>
eth1/0/22	Searching	N/A	0.0	0.0	<input type="button" value="Delete Description"/>
eth1/0/23	Searching	N/A	0.0	0.0	<input type="button" value="Delete Description"/>
eth1/0/24	Searching	N/A	0.0	0.0	<input type="button" value="Delete Description"/>

Note:
Faulty Code:

Figure 3-10 PoE Status window

The fields that can be configured are described below:

Parameter	Description
Unit	Select the switch unit that will be used for this configuration here.
From Port / To Port	Select the appropriate port range used for the configuration here.
Description	Enter the text that describes the PD connected to a PoE interface. The maximum length is 32 characters.

Click the **Delete Description** button to clear the setting in the corresponding Description field.

Click the **Apply** button to accept the changes made.

PoE Configuration

This window is used to configure the PoE port.

To view the following window, click **System > PoE > PoE Configuration**, as shown below:

PoE Configuration

PoE Configuration

Unit: 1 From Port: eth1/0/1 To Port: eth1/0/1 Priority: Low Legacy Support: Disabled Mode: Auto Max Wattage (1000-30000): Time Range:

Apply

Unit 1 Settings

Port	Admin	Priority	Legacy Support	Time Range	
eth1/0/1	Auto	Low	Disabled		Delete Time Range
eth1/0/2	Auto	Low	Disabled		Delete Time Range
eth1/0/3	Auto	Low	Disabled		Delete Time Range
eth1/0/4	Auto	Low	Disabled		Delete Time Range
eth1/0/5	Auto	Low	Disabled		Delete Time Range
eth1/0/6	Auto	Low	Disabled		Delete Time Range
eth1/0/7	Auto	Low	Disabled		Delete Time Range
eth1/0/8	Auto	Low	Disabled		Delete Time Range
eth1/0/9	Auto	Low	Disabled		Delete Time Range
eth1/0/10	Auto	Low	Disabled		Delete Time Range
eth1/0/11	Auto	Low	Disabled		Delete Time Range

Figure 3-11 PoE Configuration window

The fields that can be configured are described below:

Parameter	Description
Unit	Select the switch unit that will be used for this configuration here.
From Port / To Port	Select the appropriate port range used for the configuration here.
Priority	Select the priority for provisioning power to the port. Options to choose from are Critical , High and Low .
Legacy Support	Select this option to enable or disable the support of legacy PD.
Mode	Select the power management mode for the PoE ports. Options to choose from are Auto and Never .
Max Wattage	When selecting Auto in the Mode drop-down list, this option appears. Tick the check box and enter the maximum wattage of power that can be provisioned to the auto-detected PD. If the value is not entered, the class of the PD automatically determines the maximum wattage which can be provisioned. The valid range for maximum wattage is between 1000 mW and 30000 mW.
Time Range	When selecting Auto in the Mode drop-down list, this option appears. Tick the check box and enter the name of the time range to determine the activation period.

Click the **Delete Time Range** button to clear the setting in the corresponding Time Range field.

Click the **Apply** button to accept the changes made.

PoE Statistics

This window is used to display the PoE statistics.

To view the following window, click **System > PoE > PoE Statistics**, as shown below:

PoE Statistics						
PoE Statistics Table						
Unit	1					
Unit 1 Settings						
						Clear All
Port	MPS Absent	Overload	Short	Power Denied	Invalid Signature	
eth1/0/1	0	0	0	0	44	Clear
eth1/0/2	0	0	0	0	46	Clear
eth1/0/3	0	0	0	0	46	Clear
eth1/0/4	0	0	0	0	46	Clear
eth1/0/5	0	0	0	0	133	Clear
eth1/0/6	0	0	0	0	133	Clear
eth1/0/7	0	0	0	0	133	Clear
eth1/0/8	0	0	0	0	128	Clear
eth1/0/9	0	0	0	0	245	Clear
eth1/0/10	0	0	0	0	245	Clear
eth1/0/11	0	0	0	0	246	Clear
eth1/0/12	0	0	0	0	245	Clear
eth1/0/13	0	0	0	0	187	Clear
eth1/0/14	0	0	0	0	188	Clear
eth1/0/15	0	0	0	0	188	Clear
eth1/0/16	0	0	0	0	187	Clear
eth1/0/17	0	0	0	0	4	Clear
eth1/0/18	0	0	0	0	5	Clear
eth1/0/19	0	0	0	0	5	Clear
eth1/0/20	0	0	0	0	5	Clear
eth1/0/21	0	0	0	0	191	Clear
eth1/0/22	0	0	0	0	191	Clear
eth1/0/23	0	0	0	0	192	Clear
eth1/0/24	0	0	0	0	192	Clear

Figure 3-12 PoE Statistics window

The fields that can be configured are described below:

Parameter	Description
Unit	Select the switch unit that will be used for this configuration here.

Click the **Clear All** button to clear PoE statistics for all ports.

Click the **Clear** button to clear the PoE statistics for the corresponding port.

PoE Measurement

This window is used to display the PoE measurement.

To view the following window, click **System > PoE > PoE Measurement**, as shown below:

PoE Measurement Table

Unit: 1

Unit 1 Settings

Port	Voltage (V)	Current (mA)	Temperature (C)	Power (W)
eth1/0/1	N/A	N/A	N/A	N/A
eth1/0/2	N/A	N/A	N/A	N/A
eth1/0/3	N/A	N/A	N/A	N/A
eth1/0/4	N/A	N/A	N/A	N/A
eth1/0/5	N/A	N/A	N/A	N/A
eth1/0/6	N/A	N/A	N/A	N/A
eth1/0/7	N/A	N/A	N/A	N/A
eth1/0/8	N/A	N/A	N/A	N/A
eth1/0/9	N/A	N/A	N/A	N/A
eth1/0/10	N/A	N/A	N/A	N/A
eth1/0/11	N/A	N/A	N/A	N/A
eth1/0/12	N/A	N/A	N/A	N/A
eth1/0/13	N/A	N/A	N/A	N/A
eth1/0/14	N/A	N/A	N/A	N/A
eth1/0/15	N/A	N/A	N/A	N/A
eth1/0/16	N/A	N/A	N/A	N/A
eth1/0/17	N/A	N/A	N/A	N/A
eth1/0/18	N/A	N/A	N/A	N/A
eth1/0/19	N/A	N/A	N/A	N/A
eth1/0/20	N/A	N/A	N/A	N/A
eth1/0/21	N/A	N/A	N/A	N/A
eth1/0/22	N/A	N/A	N/A	N/A
eth1/0/23	N/A	N/A	N/A	N/A
eth1/0/24	N/A	N/A	N/A	N/A

Figure 3-13 PoE Measurement window

The fields that can be configured are described below:

Parameter	Description
Unit	Select the switch unit that will be used for this configuration here.

PoE LLDP Classification

This window is used to display the PoE LLDP Classification.

To view the following window, click **System > PoE > PoE LLDP Classification**, as shown below:

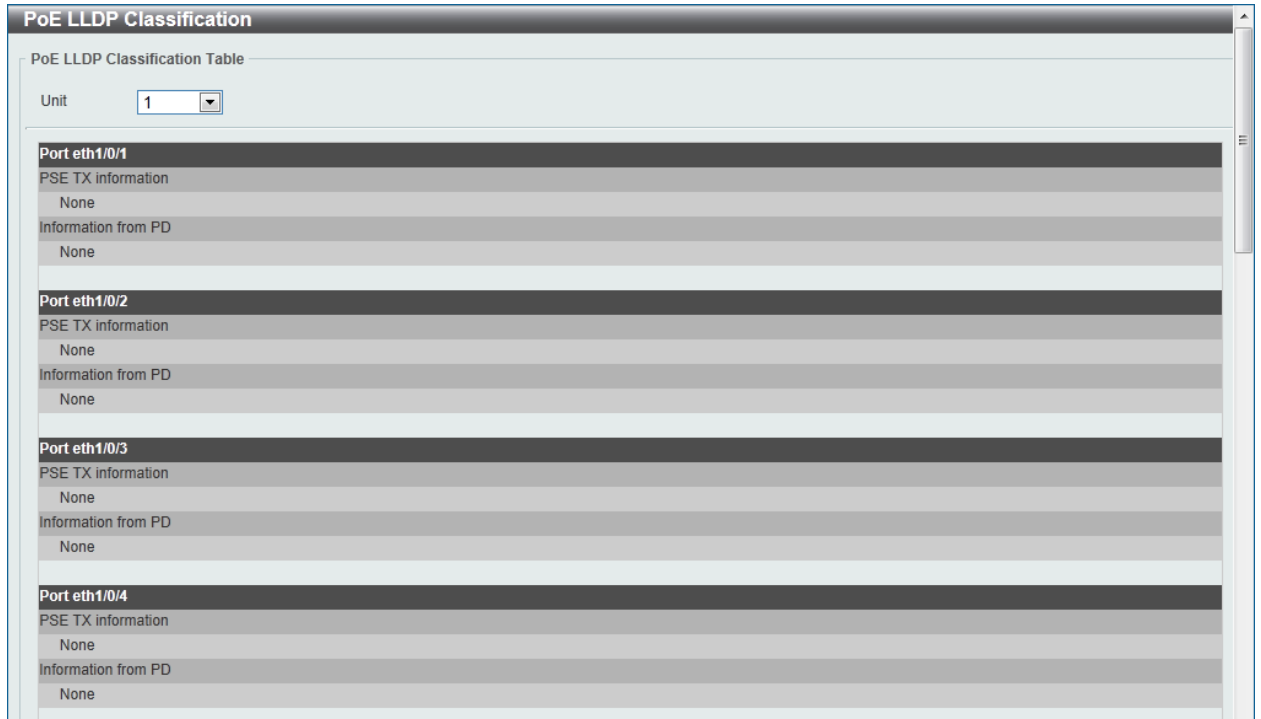

Figure 3-14 PoE LLDP Classification window

The fields that can be configured are described below:

Parameter	Description
Unit	Select the switch unit that will be used for this configuration here.

System Log

System Log Settings

This window is used to view and configure the system's log settings.

To view the following window, click **System > System Log > System Log Settings**, as shown below:

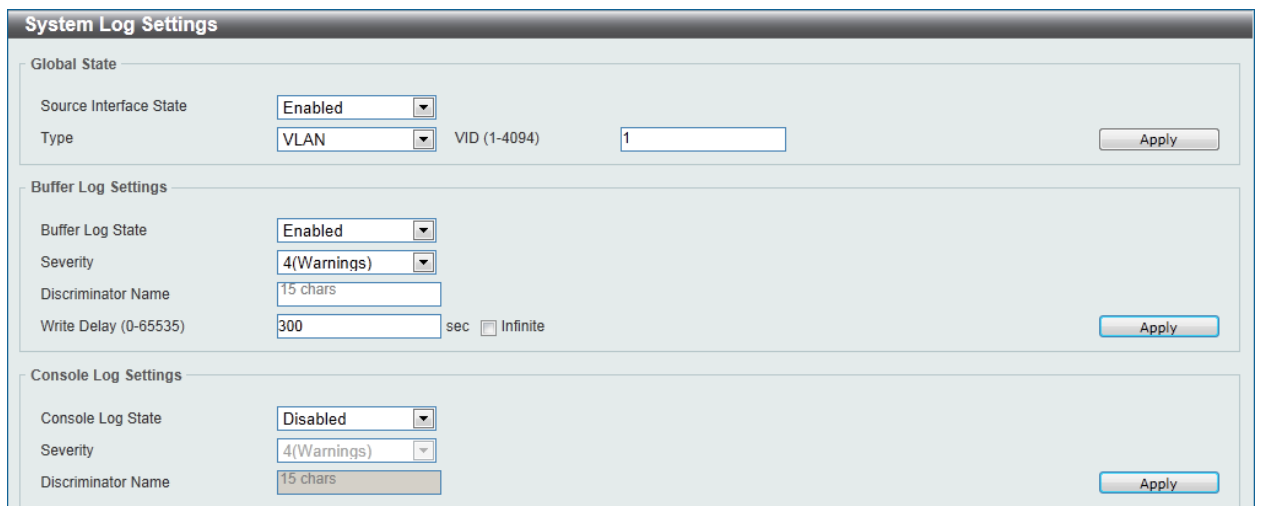

Figure 3-15 System Log Settings window

The fields that can be configured for **Global State** are described below:

Parameter	Description
Source Interface State	Select this option to enable or disable the source interface's global state.
Type	Select the type of interface that will be used. Option to choose from is VLAN .
VID	Enter the VLAN ID used here. The value is between 1 and 4094.

Click the **Apply** button to accept the changes made.

The fields that can be configured for **Buffer Log Settings** are described below:

Parameter	Description
Buffer Log State	Select whether the enable or disable the buffer log's global state here. Options to choose from are Enable , Disabled , and Default . When selecting the Default option, the buffer log's global state will follow the default behavior.
Severity	Select the severity value of the type of information that will be logged. Options to choose from are 0 (Emergencies) , 1 (Alerts) , 2 (Critical) , 3 (Errors) , 4 (Warnings) , 5 (Notifications) , 6 (Informational) , and 7 (Debugging) .
Discriminator Name	Enter the discriminator name used here. This name can be up to 15 characters long.
Write Delay	Enter the interval for periodic writing of the logging buffer to FLASH. This value must be between 0 and 65535 seconds. By default, this value is 300 seconds. Tick the Infinite option, to disable the write delay feature.

Click the **Apply** button to accept the changes made.

The fields that can be configured for **Console Log Settings** are described below:

Parameter	Description
Console Log State	Select whether the enable or disable the console log's global state here.
Severity	Select the severity value of the type of information that will be logged. Options to choose from are 0 (Emergencies) , 1 (Alerts) , 2 (Critical) , 3 (Errors) , 4 (Warnings) , 5 (Notifications) , 6 (Informational) , and 7 (Debugging) .
Discriminator Name	Enter the discriminator name used here. This name can be up to 15 characters long.

Click the **Apply** button to accept the changes made.

System Log Discriminator Settings

This window is used to view and configure the system log's discriminator settings.

To view the following window, click **System > System Log > System Log Discriminator Settings**, as shown below:

Name	Action	Facility List	Severity	Severity List
Discriminato...	Drops	LAC,QOS,STORM_CTRL,D...		

Figure 3-16 System Log Discriminator Settings window

The fields that can be configured are described below:

Parameter	Description
Discriminator	Enter the discriminator name here. This name can be up to 15 characters long.
Facility	Select the facility's behavior option and the type of facility that will be associated with the selected behavior here. Behavior options to choose from are Drops and Includes .
Severity	Select the severity behavior option and the value of the type of information that will be logged. Behavior options to choose from are Drops and Includes . Severity value options to choose from are 0 (Emergencies) , 1 (Alerts) , 2 (Critical) , 3 (Errors) , 4 (Warnings) , 5 (Notifications) , 6 (Informational) , and 7 (Debugging) .

Click the **Apply** button to accept the changes made.

Click the **Delete** button to remove the specified entry.

System Log Server Settings

This window is used to view and configure system log's server settings.

To view the following window, click **System > System Log > System Log Server Settings**, as shown below:

Server IP	Severity	Facility	Discriminator Name	UDP Port
10.90.90.254	Warnings	0		514

Figure 3-17 System Log Server Settings window

The fields that can be configured are described below:

Parameter	Description
Host IPv4 Address	Enter the system log server's IPv4 address here.
Host IPv6 Address	Enter the system log server's IPv6 address here.
UDP Port	Enter the system log server's UDP port number here. This value must be 514 or between 1024 and 65535. By default, this value is 514.
Severity	Select the severity value of the type of information that will be logged. Options to choose from are 0 (Emergencies) , 1 (Alerts) , 2 (Critical) , 3 (Errors) , 4 (Warnings) , 5 (Notifications) , 6 (Informational) , and 7 (Debugging) .
Facility	Select the facility value here. Options to choose from are 0 to 23.
Discriminator Name	Enter the discriminator name here. This name can be up to 15 characters long.

Click the **Apply** button to accept the changes made.

Click the **Delete** button to remove the specified entry.

System Log

This window is used to view and clear the system log.

To view the following window, click **System > System Log > System Log**, as shown below:

Index	Time	Level	Log Description
2	2000-01-01 00:00:36	CRIT(2)	System started up
1	2000-01-01 00:00:36	CRIT(2)	System warm start

Figure 3-18 System Log window

Click the **Clear Log** button to clear the system log entries displayed in the table.

Enter a page number and click the **Go** button to navigate to a specific page when multiple pages exist.

System Attack Log

This window is used to view and clear the system attack log.

To view the following window, click **System > System Log > System Attack Log**, as shown below:

Figure 3-19 System Attack Log window

The fields that can be configured are described below:

Parameter	Description
Unit	Select the switch unit that will be used for this configuration here.

Click the **Clear Attack Log** button to clear the system attack log entries displayed in the table.

Time and SNTP

The Simple Network Time Protocol (SNTP) is a protocol for synchronizing computer clocks through the Internet. It provides comprehensive mechanisms to access national time and frequency dissemination services, organize the SNTP subnet of servers and clients, and adjust the system clock in each participant.

Clock Settings

This window is used to configure the time settings for the Switch.

To view the following window, click **System > Time and SNTP > Clock Settings**, as shown below:

Figure 3-20 Clock Settings window

The fields that can be configured are described below:

Parameter	Description
Time (HH:MM:SS)	Enter the current time in hours, minutes, and seconds.
Date (DD / MM / YYYY)	Enter the current day, month, and year to update the system clock.

Click the **Apply** button to accept the changes made.

Time Zone Settings

This window is used to configure time zones and Daylight Savings Time settings for SNTP.

To view the following window, click **System > Time and SNTP > Time Zone Settings**, as shown below:

The screenshot shows the 'Time Zone Settings' window. It is divided into three sections:

- Summer Time State:** A dropdown menu set to 'Disabled'.
- Time Zone:** A dropdown menu with '+' and '0' buttons, and another dropdown set to '0'.
- Recurring Setting:**
 - From: Week of the Month: Last
 - From: Day of the Week: Sun
 - From: Month: Jan
 - From: Time (HH:MM): 00:00
 - To: Week of the Month: Last
 - To: Day of the Week: Sun
 - To: Month: Jan
 - To: Time (HH:MM): 00:00
 - Offset: 60
- Date Setting:**
 - From: Date of the Month: 01
 - From: Month: Jan
 - From: Year: (empty)
 - From: Time (HH:MM): 00:00
 - To: Date of the Month: 01
 - To: Month: Jan
 - To: Year: (empty)
 - To: Time (HH:MM): 00:00
 - Offset: 60

An 'Apply' button is located at the bottom right of the window.

Figure 3-21 Time Zone Settings window

The fields that can be configured are described below:

Parameter	Description
Summer Time State	Select the summer time setting. Options to choose from are Disabled , Recurring Setting , and Date Setting . Disabled - Select to disable the summer time setting. Recurring Setting - Select to configure the summer time that should start and end on the specified week day of the specified month. Date Setting - Select to configure the summer time that should start and end on the specified date of the specified month.
Time Zone	Select to specify your local time zone's offset from Coordinated Universal Time (UTC).

The fields that can be configured for **Recurring Setting** are described below:

Parameter	Description
From: Week of the Month	Select week of the month that summer time will start.
From: Day of the Week	Select the day of the week that summer time will start.
From: Month	Select the month that summer time will start.
From: Time (HH:MM)	Select the time of the day that summer time will start.
To: Week of the Month	Select week of the month that summer time will end.
To: Day of the Week	Select the day of the week that summer time will end.

To: Month	Select the month that summer time will end.
To: Time (HH:MM)	Select the time of the day that summer time will end.
Offset	Enter the number of minutes to add during summer time. The default value is 60. The range of this offset is 30, 60, 90 and 120.

The fields that can be configured for **Date Setting** are described below:

Parameter	Description
From: Date of the Month	Select date of the month that summer time will start.
From: Month	Select the month that summer time will start.
From: Year	Enter the year that the summer time will start.
From: Time (HH:MM)	Select the time of the day that summer time will start.
To: Date of the Month	Select date of the month that summer time will end.
To: Month	Select the month that summer time will end.
To: Year	Enter the year that the summer time will end.
To: Time (HH:MM)	Select the time of the day that summer time will end.
Offset	Enter the number of minutes to add during summer time. The default value is 60. The range of this offset is 30, 60, 90 and 120.

Click the **Apply** button to accept the changes made.

SNTP Settings

This window is used to configure the time settings for the Switch.

To view the following window, click **System > Time and SNTP > SNTP Settings**, as shown below:

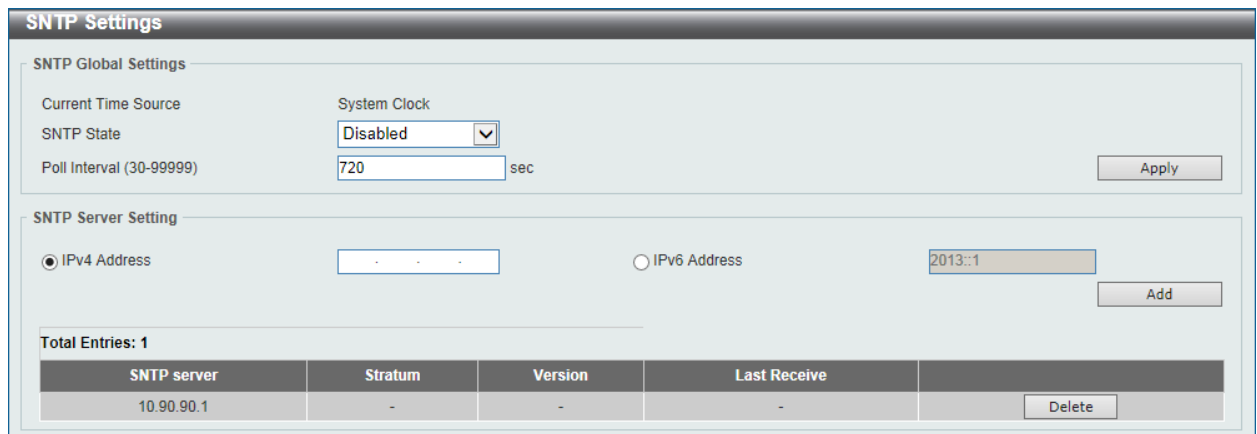

Figure 3-22 SNTP Settings window

The fields that can be configured for **SNTP Global Settings** are described below:

Parameter	Description
SNTP State	Select this option to enable or disable SNTP.
Poll Interval	Enter the synchronizing interval in seconds. The value is from 30 to 99999 seconds. The default interval is 720 seconds.

Click the **Apply** button to accept the changes made.

The fields that can be configured for **SNTP Server Setting** are described below:

Parameter	Description
IPv4 Address	Enter the IP address of the SNTP server which provides the clock synchronization.
IPv6 Address	Enter the IPv6 address of the SNTP server which provides the clock synchronization.

Click the **Add** button to add the SNTP server.

Click the **Delete** button to remove the specified entry.

Time Range

This window is used to view and configure the time range settings.

To view the following window, click **System > Time Range**, as shown below:

Figure 3-23 Time Range window

The fields that can be configured are described below:

Parameter	Description
Range Name	Enter the name of the time range. This name can be up to 32 characters long.
From Week / To Week	Select the starting and ending days of the week that will be used for this time range. Tick the Daily option to use this time range for every day of the week. Tick the End Week Day option to use this time range from the starting day of the week until the end of the week, which is Sunday.
From Time / To Time	Select the starting and ending time of the day that will be used for this time range. The first drop-down menu selects the hour and the second drop-down menu selects the minute.

Click the **Apply** button to accept the changes made.

Click the **Find** button to locate a specific entry based on the information entered.

Click the **Delete Periodic** button to delete the periodic entry.

Click the **Delete** button to remove the specified entry.

Enter a page number and click the **Go** button to navigate to a specific page when multiple pages exist.

4. Management

User Account Settings
Password Encryption
Login Method
SNMP
RMON
Telnet/Web
Session Timeout
DHCP
DNS
IP Source Interface
File System
Physical Stacking
Virtual Stacking (SIM)
D-Link Discovery Protocol

User Account Settings

This window is used to create and configure the user accounts. The active user account sessions can be viewed.



NOTE: By default, there is no user account created on the Switch.

There are several configuration options available in the Web User Interface (Web UI). The set of configuration options available to the user depends on the account's **Privilege Level**. A user account created with a higher privilege level will be given access to configure more features than a user account created with a lower privilege level.

The pre-defined user account privilege levels supported by this switch are:

- **Basic User - Privilege Level 1.** This user account level has the lowest priority of the user accounts. The purpose of this type of user account level is for basic system checking.
- **Operator - Privilege Level 12.** This user account level is used to grant system configuration rights for users who need to change or monitor system configuration, except for security related information such as user accounts and SNMP account settings.
- **Administrator - Privilege Level 15.** This administrator user account level can monitor all system information and change any of the system configuration settings expressed in this guide.

To view the following window, click **Management > User Account Settings**, as shown below:

User Accounts Settings

User Management Settings | Session Table

User Name: 32 chars | Privilege (1-15): | Password Type: None | Password: | Apply

Total Entries: 1

User Name	Privilege	Password
admin	15	*****

1/1 | < > | 1 | > > | Go

Figure 4-1 User Management Settings window

The fields that can be configured are described below:

Parameter	Description
User Name	Enter the user account name here. This name can be up to 32 characters long.
Privilege	Enter the privilege level for this account here. This value must be between 1 and 15.
Password Type	Select the password type for this user account here. Options to choose from are None , Plain Text , and Encrypted .
Password	After selecting either Plain Text or Encrypted as the password type, enter the password for this user account here.

Click the **Apply** button to accept the changes made.

Click the **Delete** button to remove the specified user account entry.

Enter a page number and click the **Go** button to navigate to a specific page when multiple pages exist.

After clicking the **Session Table** tab, the following page will appear.

User Accounts Settings

User Management Settings | Session Table

Total Entries: 1

Type	User Name	Privilege	Login Time	IP Address
console	anonymous	1	2H42M3S	

Figure 4-2 Session Table window

A list of active user account session will be displayed.

Password Encryption

This window is used to configure whether to save the encryption of the password in the configuration file.

To view the following window, click **Management > Password Encryption**, as shown below:

Figure 4-3 Password Encryption window

The fields that can be configured are described below:

Parameter	Description
Password Encryption State	Select this option to enable or disable the encryption of the password before stored in the configuration file.

Click the **Apply** button to accept the changes made.

Login Method

This window is used to configure the login method for each management interface that this Switch supports.

To view the following window, click **Management > Login Method**, as shown below:

Figure 4-4 Login Method window

The **Login Method** section will only be available when Authentication, Authorization, and Accounting (AAA) feature is disabled. The fields that can be configured for **Login Method** settings are described below:

Parameter	Description
Login Method	After clicking the Edit button this parameter can be configured. Select the login method for the specified application here. Options to choose from are No Login , Login and Login Local . No Login , as the name implies, requires no login authentication to access the specified application. Login will require the user to at least enter a password when trying to access the application specified. Login Local requires the user to enter a username and a password to access the specified application.

The fields that can be configured for **Login Method** settings are described below:

Parameter	Description
Application	Select the application that will be configured here. Options to choose from are Console , Telnet and SSH .
Password Type	Select the password encryption type that will be used here. Options to choose from are Plain Text and Encrypted .
Password	Enter the password for the selected application here. This password will be used when the Login Method for the specified application is set as Login .

Click the **Apply** button to accept the changes made.

Click the **Delete** button to remove the password from the specified application.

SNMP

Simple Network Management Protocol (SNMP) is an OSI Layer 7 (Application Layer) designed specifically for managing and monitoring network devices. SNMP enables network management stations to read and modify the settings of gateways, routers, switches, and other network devices. Use SNMP to configure system features for proper operation, monitor performance and detect potential problems in the Switch, switch group or network.

Managed devices that support SNMP include software (referred to as an agent), which runs locally on the device. A defined set of variables (managed objects) is maintained by the SNMP agent and used to manage the device. These objects are defined in a Management Information Base (MIB), which provides a standard presentation of the information controlled by the on-board SNMP agent. SNMP defines both the format of the MIB specifications and the protocol used to access this information over the network.

The Switch supports the SNMP versions 1, 2c, and 3. The three versions of SNMP vary in the level of security provided between the management station and the network device.

In SNMP v.1 and v.2, user authentication is accomplished using 'community strings', which function like passwords. The remote user SNMP application and the Switch SNMP must use the same community string. SNMP packets from any station that has not been authenticated are ignored (dropped).

The default community strings for the Switch used for SNMP v.1 and v.2 management access are:

- **public** – Allows authorized management stations to retrieve MIB objects.
- **private** – Allows authorized management stations to retrieve and modify MIB objects.

SNMPv3 uses a more sophisticated authentication process that is separated into two parts. The first part is to maintain a list of users and their attributes that are allowed to act as SNMP managers. The second part describes what each user on that list can do as an SNMP manager.

The Switch allows groups of users to be listed and configured with a shared set of privileges. The SNMP version may also be set for a listed group of SNMP managers. Thus, you may create a group of SNMP managers that are allowed to view read-only information or receive traps using SNMPv1 while assigning a higher level of security to another group, granting read/write privileges using SNMPv3.

Using SNMPv3 individual users or groups of SNMP managers can be allowed to perform or be restricted from performing specific SNMP management functions. The functions allowed or restricted are defined using the Object Identifier (OID) associated with a specific MIB. An additional layer of security is available for SNMPv3 in that SNMP messages may be encrypted. To read more about how to configure SNMPv3 settings for the Switch read the next section.

Traps

Traps are messages that alert network personnel of events that occur on the Switch. The events can be as serious as a reboot (someone accidentally turned OFF the Switch), or less serious like a port status change. The Switch generates traps and sends them to the trap recipient (or network manager). Typical traps include trap messages for Authentication Failure, Topology Change and Broadcast\Multicast Storm.

MIBs

The Switch in the Management Information Base (MIB) stores management and counter information. The Switch uses the standard MIB-II Management Information Base module. Consequently, values for MIB objects can be retrieved from any SNMP-based network management software. In addition to the standard MIB-II, the Switch also supports its own proprietary enterprise MIB as an extended Management Information Base. Specifying the MIB Object Identifier may also retrieve the proprietary MIB. MIB values can be either read-only or read-write.

The Switch incorporates a flexible SNMP management for the switching environment. SNMP management can be customized to suit the needs of the networks and the preferences of the network administrator. Use the SNMP V3 menus to select the SNMP version used for specific tasks.

The Switch supports the Simple Network Management Protocol (SNMP) versions 1, 2c, and 3. The administrator can specify the SNMP version used to monitor and control the Switch. The three versions of SNMP vary in the level of security provided between the management station and the network device.

SNMP settings are configured using the menus located on the SNMP V3 folder of the Web manager. Workstations on the network that are allowed SNMP privileged access to the Switch can be restricted with the Management Station IP Address menu.

SNMP Global Settings

This window is used to configure the SNMP global settings and trap settings.

To view the following window, click **Management > SNMP > SNMP Global Settings**, as shown below:

Figure 4-5 SNMP Global Settings window

The fields that can be configured for **SNMP Global Settings** are described below:

Parameter	Description
-----------	-------------

SNMP Global State	Select this option to enable or disable the SNMP feature.
SNMP Response Broadcast Request	Select this option to enable or disable the server to response to broadcast SNMP GetRequest packets.
SNMP UDP Port	Enter the SNMP UDP port number.
Trap Source Interface	Enter the interface whose IP address will be used as the source address for sending the SNMP trap packet.

The fields that can be configured for **Trap Settings** are described below:

Parameter	Description
Trap Global State	Select this option to enable or disable the sending of all or specific SNMP notifications.
SNMP Authentication Trap	Tick this option to control the sending of SNMP authentication failure notifications. An authenticationFailuretrap is generated when the device receives an SNMP message that is not properly authenticated. The authentication method depends on the version of SNMP being used. For SNMPv1 or SNMPv2c, authentication failure occurs if packets are formed with an incorrect community string. For SNMPv3, authentication failure occurs if packets are formed with an incorrect SHA/MD5 authentication key.
Port Link Up	Tick this option to control the sending of port link up notifications. A linkup trap is generated when the device recognizes that one of the communication links has come up.
Port Link Down	Tick this option to control the sending of port link down notifications. A linkDown trap is generated when the device recognizes a failure in one of the communication links.
Coldstart	Tick this option to control the sending of SNMP coldStart notifications.
Warmstart	Tick this option to control the sending of SNMP warmStart notifications.

Click the **Apply** button to accept the changes made.

SNMP Linkchange Trap Settings

This window is used to configure the SNMP link change trap settings.

To view the following window, click **Management > SNMP > SNMP Linkchange Trap Settings**, as shown below:

SNMP Linkchange Trap Settings

Unit: 1 From Port: eth1/0/1 To Port: eth1/0/1 Trap Sending: Disabled Trap State: Disabled Apply

Port	Trap Sending	Trap State
eth1/0/1	Enabled	Enabled
eth1/0/2	Enabled	Enabled
eth1/0/3	Enabled	Enabled
eth1/0/4	Enabled	Enabled
eth1/0/5	Enabled	Enabled
eth1/0/6	Enabled	Enabled
eth1/0/7	Enabled	Enabled
eth1/0/8	Enabled	Enabled
eth1/0/9	Enabled	Enabled
eth1/0/10	Enabled	Enabled
eth1/0/11	Enabled	Enabled
eth1/0/12	Enabled	Enabled
eth1/0/13	Enabled	Enabled
eth1/0/14	Enabled	Enabled
eth1/0/15	Enabled	Enabled

Figure 4-6 SNMP Linkchange Trap Settings window

The fields that can be configured are described below:

Parameter	Description
Unit	Select the switch unit that will be used for this configuration here.
From Port / To Port	Select the appropriate port range used for the configuration here.
Trap Sending	Select this option to enable or disable the sending of the SNMP notification traps that is generated by the system.
Trap State	Select this option to enable or disable the SNMP link change trap.

Click the **Apply** button to accept the changes made.

SNMP View Table Settings

This window is used to assign views to community strings that define which MIB objects can be accessed by a remote SNMP manager. The SNMP Group created with this table maps SNMP users (identified in the SNMP User Table) to the views created in the previous window.

To view the following window, click **Management > SNMP > SNMP View Table Settings**, as shown below:

SNMP View Table Settings

SNMP View Settings

View Name *

Subtree OID *

View Type

* Mandatory Field

Total Entries: 8

View Name	Subtree OID	View Type	
restricted	1.3.6.1.2.1.1	Included	<input type="button" value="Delete"/>
restricted	1.3.6.1.2.1.11	Included	<input type="button" value="Delete"/>
restricted	1.3.6.1.6.3.10.2.1	Included	<input type="button" value="Delete"/>
restricted	1.3.6.1.6.3.11.2.1	Included	<input type="button" value="Delete"/>
restricted	1.3.6.1.6.3.15.1.1	Included	<input type="button" value="Delete"/>
CommunityView	1	Included	<input type="button" value="Delete"/>
CommunityView	1.3.6.1.6.3	Excluded	<input type="button" value="Delete"/>
CommunityView	1.3.6.1.6.3.1	Included	<input type="button" value="Delete"/>

Figure 4-7 SNMP View Table Settings window

The fields that can be configured are described below:

Parameter	Description
View Name	Type an alphanumeric string of up to 32 characters. This is used to identify the new SNMP view being created.
Subtree OID	Type the Object Identifier (OID) Subtree for the view. The OID identifies an object tree (MIB tree) that will be included or excluded from access by an SNMP manager.
View Type	Select the view type here. Options to choose from are Included , and Excluded . Included - Select to include this object in the list of objects that an SNMP manager can access. Excluded - Select to exclude this object from the list of objects that an SNMP manager can access.

Click the **Add** button to add a new entry based on the information entered.

Click the **Delete** button to remove the specified entry.

SNMP Community Table Settings

This window is used to create an SNMP community string to define the relationship between the SNMP manager and an agent. The community string acts like a password to permit access to the agent on the Switch. One or more of the following characteristics can be associated with the community string:

- An Access List of IP addresses of SNMP managers that are permitted to use the community string to gain access to the Switch's SNMP agent.
- Any MIB view that defines the subset of all MIB objects will be accessible to the SNMP community.
- Read/write or read-only level permission for the MIB objects accessible to the SNMP community.

To view the following window, click **Management > SNMP > SNMP Community Table Settings**, as shown below:

The image shows the 'SNMP Community Table Settings' window. It contains several configuration fields: 'Key Type' (set to 'Plain Text'), 'Community Name' (32 chars), 'View Name' (32 chars), 'Access Right' (set to 'Read Only'), and 'IP Access-List Name' (32 chars). An 'Add' button is located to the right of these fields. Below the fields, it says 'Total Entries: 2' and displays a table with two entries. Each entry has a 'Delete' button next to it.

Community Name	View Name	Access Right	IP Access-List Name	
private	CommunityView	rw		Delete
public	CommunityView	ro		Delete

Figure 4-8 SNMP Community Table Settings window

The fields that can be configured are described below:

Parameter	Description
Key Type	Select the key type for the SNMP community. Options to choose from are Plain Text , and Encrypted .
Community Name	Enter an alphanumeric string of up to 32 characters that is used to identify members of an SNMP community. This string is used like a password to give remote SNMP managers access to MIB objects in the Switch's SNMP agent.
View Name	Enter an alphanumeric string of up to 32 characters that is used to identify the group of MIB objects that a remote SNMP manager is allowed to access on the Switch. The view name must exist in the SNMP View Table.
Access Right	Select the access right here. Options to choose from are Read Only , and Read Write . Read Only - SNMP community members using the community string created can only read the contents of the MIBs on the Switch. Read Write - SNMP community members using the community string created can read from, and write to the contents of the MIBs on the Switch.
IP Access-List Name	Enter the name of the standard access list to control the user to use this community string to access to the SNMP agent.

Click the **Add** button to add a new entry based on the information entered.

Click the **Delete** button to remove the specified entry.

SNMP Group Table Settings

An SNMP Group created with this table maps SNMP users (identified in the SNMP User Table) to the views created in the previous window.

To view the following window, click **Management > SNMP > SNMP Group Table Settings**, as shown below:

SNMP Group Table Settings

SNMP Group Settings

Group Name * Read View Name

User-based Security Model Write View Name

Security Level Notify View Name

IP Address-List Name

* Mandatory Field

Total Entries: 5

Group Name	Read View Name	Write View Name	Notify View Name	Security Model	Security Level	IP Address-List Name	
public	CommunityV...		CommunityV...	v1			<input type="button" value="Delete"/>
public	CommunityV...		CommunityV...	v2c			<input type="button" value="Delete"/>
initial	restricted		restricted	v3	NoAuthNoPriv		<input type="button" value="Delete"/>
private	CommunityV...	CommunityV...	CommunityV...	v1			<input type="button" value="Delete"/>
private	CommunityV...	CommunityV...	CommunityV...	v2c			<input type="button" value="Delete"/>

Figure 4-9 SNMP Group Table Settings window

The fields that can be configured are described below:

Parameter	Description
Group Name	Enter the group name of a maximum of 32 characters. The syntax is general string that does not allow space.
User-based Security Model	Select the security model here. Options to choose from are SNMPv1 , SNMPv2c , and SNMPv3 . SNMPv1 - Select to allow the group user to use the SNMPv1 security model. SNMPv2c - Select to allow the group user to use the SNMPv2c security model. SNMPv3 - Select to allow the group user to use the SNMPv3 security model.
Security Level	When selecting SNMPv3 in the User-based Security Model drop-down list, this option is available. NoAuthNoPriv - Specify that there will be no authorization and no encryption of packets sent between the Switch and a remote SNMP manager. AuthNoPriv - Specify that authorization will be required, but there will be no encryption of packets sent between the Switch and a remote SNMP manager. AuthPriv - Specify that authorization will be required, and that packets sent between the Switch and a remote SNMP manger will be encrypted.
IP Address-List Name	Enter the standard IP access control list (ACL) to associate with the group.
Read View Name	Enter the read view name that the group user can access.
Write View Name	Enter the write view name that the group user can access.
Notify View Name	Enter a write view name that the group user can access. The notify view describes the object that can be reported its status via trap packets to the group user.

Click the **Add** button to add a new entry based on the information entered.

Click the **Delete** button to remove the specified entry.

SNMP Engine ID Local Settings

The Engine ID is a unique identifier used for SNMP V3 implementations on the Switch.

To view the following window, click **Management > SNMP > SNMP Engine ID Local Settings**, as shown below:

Figure 4-10 SNMP Engine ID Local Settings window

The fields that can be configured are described below:

Parameter	Description
Engine ID	Enter the engine ID string with the maximum of 24 characters.

Click the **Default** button to revert the engine ID to the default.

Click the **Apply** button to accept the changes made.

SNMP User Table Settings

This window is used to configure and display the SNMP users that are currently configured on the Switch.

To view the following window, click **Management > SNMP > SNMP User Table Settings**, as shown below:

User Name	Group Name	Security Model	Authentication Protocol	Privacy Protocol	Engine ID	IP Address-List Name	
initial	initial	V3	None	None	800000ab03...		Delete

Figure 4-11 SNMP User Table Settings window

The fields that can be configured are described below:

Parameter	Description
User Name	Enter an alphanumeric string of up to 32 characters. This is used to

	identify the SNMP users.
Group Name	Enter the SNMP group name to which the user belongs. The syntax is general string that does not allow spaces.
SNMP Version	Select the SNMP version. Options to choose from are v1 , v2c , and v3 .
SNMP V3 Encryption	When selecting v3 in the SNMP Version drop-down list, this option is available. Options to choose from are None , Password , and Key .
Auth-Protocol	When selecting v3 in the SNMP Version drop-down list, and selecting either Password or Key in the SNMP V3 Encryption drop-down list, this option is available. Select the authentication level. Options to choose from are MD5 , and SHA . MD5 - Select to use the HMAC-MD5-96 authentication level. This field will require the user to enter a password or a key. SHA - Specify that the HMAC-SHA authentication protocol will be used. This field will require the user to enter a password or a key.
Priv-Protocol	When selecting v3 in the SNMP Version drop-down list, and selecting either Password or Key in the SNMP V3 Encryption drop-down list, this option is available. Select the private protocol. Options to choose from are None , and DES56 . None - Specify that no authorization protocol is in use. DES56 - Specify that DES 56-bit encryption is in use, based on the CBC-DES (DES-56) standard. This field will require the user to enter a password or a key.
IP Address-List Name	Enter the standard IP access control list (ACL) to associate with the user.

Click the **Add** button to add a new entry based on the information entered.

Click the **Delete** button to remove the specified entry.

SNMP Host Table Settings

This window is used to configure and display the recipient of the SNMP notification.

To view the following window, click **Management > SNMP > SNMP Host Table Settings**, as shown below:

The screenshot shows the 'SNMP Host Table Settings' window. It contains several configuration fields:

- Host IP Address:** Radio buttons for 'Host IPv4 Address' (selected) and 'Host IPv6 Address' (with value '2013::1').
- User-based Security Model:** A dropdown menu set to 'SNMPv1'.
- Security Level:** A dropdown menu set to 'NoAuthNoPriv'.
- UDP Port (0-65535):** A text input field with the value '162'.
- Community String / SNMPv3 User Name:** A text input field with the value '32 chars'.

 Below these fields is a table showing the current configuration:

Host IP Address	SNMP Version	UDP Port	Community String / SNMPv3 User Name	
10.90.90.20	V1	162	public	Delete

 There are 'Add' and 'Delete' buttons at the bottom right of the configuration area.

Figure 4-12 SNMP Host Table Settings

The fields that can be configured are described below:

Parameter	Description
-----------	-------------

Host IPv4 Address	Enter the IPv4 address of the SNMP notification host.
Host IPv6 Address	Enter the IPv6 address of the SNMP notification host.
User-based Security Model	Select the security model here. Options to choose from are SNMPv1 , SNMPv2c , and SNMPv3 . SNMPv1 - Select to allow the group user to use the SNMPv1 security model. SNMPv2c - Select to allow the group user to use the SNMPv2c security model. SNMPv3 - Select to allow the group user to use the SNMPv3 security model.
Security Level	When selecting SNMPv3 in the User-based Security Model drop-down list, this option is available. NoAuthNoPriv - Specify that there will be no authorization and no encryption of packets sent between the Switch and a remote SNMP manager. AuthNoPriv - Specify that authorization will be required, but there will be no encryption of packets sent between the Switch and a remote SNMP manager. AuthPriv - Specify that authorization will be required, and that packets sent between the Switch and a remote SNMP manger will be encrypted.
UDP Port	Enter the UDP port number. The default trap UDP port number is 162. The range of UDP port numbers is from 0 to 65535. Some port numbers may conflict with other protocols.
Community String / SNMPv3 User Name	Enter the community string to be sent with the notification packet.

Click the **Add** button to add a new entry based on the information entered.

Click the **Delete** button to remove the specified entry.

RMON

RMON Global Settings

This window is used to enable or disable remote monitoring (RMON) for the rising and falling alarm trap feature for the SNMP function on the Switch.

To view the following window, click **Management > RMON > RMON Global Settings**, as shown below:

Figure 4-13 RMON Global Settings window

The fields that can be configured are described below:

Parameter	Description
RMON Rising Alarm Trap	Select this option to enable or disable the RMON Rising Alarm Trap

	Feature.
RMON Falling Alarm Trap	Select this option to enable or disable the RMON Falling Alarm Trap Feature.

Click the **Apply** button to accept the changes made.

RMON Statistics Settings

This window is used to configure and display the RMON statistics on the specified port.

To view the following window, click **Management > RMON > RMON Statistics Settings**, as shown below:

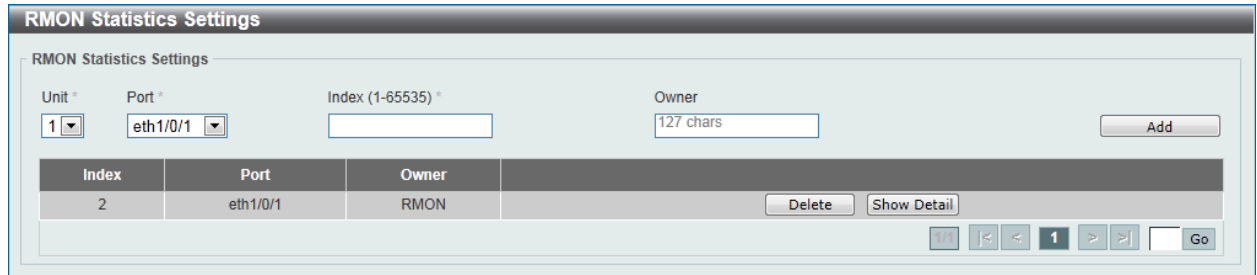

Figure 4-14 RMON Statistics Settings window

The fields that can be configured are described below:

Parameter	Description
Unit	Select the switch unit that will be used for this configuration here.
Port	Select to choose the port.
Index	Enter the RMON table index. The value is from 1 to 65535
Owner	Enter the owner string. The string can be up to 127 characters.

Click the **Add** button to add a new entry based on the information entered.

Click the **Delete** button to remove the specified entry.

Click the **Show Detail** button to see the detail information of the specific port.

Enter a page number and click the **Go** button to navigate to a specific page when multiple pages exist.

After clicking the **Show Detail** button, the following window will appear.

Figure 4-15 RMON Statistics Table window

Click the **Back** button to return to the previous window.

RMON History Settings

This window is used to configure and display RMON MIB history statistics gathering on the specified port. To view the following window, click **Management > RMON > RMON History Settings**, as shown below:

Figure 4-16 RMON History Settings window

The fields that can be configured are described below:

Parameter	Description
Unit	Select the switch unit that will be used for this configuration here.
Port	Select to choose the port.
Index	Enter the history group table index. The value is from 1 to 65535
Bucket Number	Enter Specifies the number of buckets specified for the RMON collection history group of statistics. The range is from 1 to 65535. The default value is 50.
Interval	Enter the time in seconds in each polling cycle. The range is from 1 to 3600.
Owner	Enter the owner string. The string can be up to 127 characters.

Click the **Add** button to add a new entry based on the information entered.

Click the **Delete** button to remove the specified entry.

Click the **Show Detail** button to see the detail information of the specific port.

Enter a page number and click the **Go** button to navigate to a specific page when multiple pages exist.

After clicking the **Show Detail** button, the following window will appear.

Figure 4-17 RMON History Table window

Click the **Back** button to return to the previous window.

RMON Alarm Settings

This window is used to configure and display alarm entries to monitor an interface.

To view the following window, click **Management > RMON > RMON Alarm Settings**, as shown below:

Figure 4-18 RMON Alarm Settings window

The fields that can be configured are described below:

Parameter	Description
Index	Enter the alarm index. The range is from 1 to 65535.
Interval	Enter the interval in seconds for the sampling of the variable and checking against the threshold. The valid range is from 1 to 2147483648 seconds.
Variable	Enter the object identifier of the variable to be sampled.
Type	Select the monitoring type. Options to choose from are Absolute and Delta .
Rising Threshold	Enter the rising threshold value between 0 and 2147483647.
Falling Threshold	Enter the falling threshold value between 0 and 2147483647.
Rising Event Number	Enter the index of the event entry that is used to notify the rising threshold crossing event. The valid range is from 1 to 65535. If not specified, no action is taken while crossing the rising threshold.
Falling Event Number	Enter the index of the event entry that is used to notify the falling threshold crossing event. The valid range is from 1 to 65535. If not specified, no action is taken while crossing the falling threshold.
Owner	Enter the owner string up to 127 characters.

Click the **Add** button to add a new entry based on the information entered.

Click the **Delete** button to remove the specified entry.

Enter a page number and click the **Go** button to navigate to a specific page when multiple pages exist.

RMON Event Settings

This window is used to configure and display event entries.

To view the following window, click **Management > RMON > RMON Event Settings**, as shown below:

RMON Event Settings

RMON Event Settings

Index (1-65535) *

Description 1-127 chars

Type None

Community 1-127 chars

Owner 1-127 chars

Add

Total Entries: 1

Index	Description	Community	Event Trigger	Owner	Last Trigger Time
1	event	commuity	Log and Trap	owner	0d:0h:0m:0s

Delete View Logs

1 Go

Figure 4-19 RMON Event Settings

The fields that can be configured are described below:

Parameter	Description
Index	Enter the index of the alarm entry between 1 and 65535.
Description	Enter a description for the RMON event entry. The string is up to 127 characters long.
Type	Select the RMON event entry type. Options to choose from are None , Log , Trap , and Log and Trap .
Community	Enter the community string. The string can be up to 127 characters.
Owner	Enter the owner string. The string can be up to 127 characters.

Click the **Add** button to add a new entry based on the information entered.

Click the **Delete** button to remove the specified entry.

Click the **View Logs** button to see the detail information of the specific port.

Enter a page number and click the **Go** button to navigate to a specific page when multiple pages exist.

After clicking the **View Logs** button, the following window will appear.

Event Logs Table

Event Logs Table

Event Index: 1

Total Entries: 0

Log Index	Log Time	Log Description
-----------	----------	-----------------

Back

Figure 4-20 Event Logs Table window

Click the **Back** button to return to the previous window.

Telnet/Web

This window is used to configure Telnet and Web settings on the Switch.

To view the following window, click **Management > Telnet/Web**, as shown below:

Figure 4-21 Telnet/Web window

The fields that can be configured for **Telnet Settings** are described below:

Parameter	Description
Telnet State	Select this option to enable or disable the configuration through Telnet.
Port	Enter the TCP port number used for Telnet management of the Switch. The “well-known” TCP port for the Telnet protocol is 23.

Click the **Apply** button to accept the changes made.

The fields that can be configured for **Web Setting** are described below:

Parameter	Description
Web State	Select this option to enable or disable the configuration through the web.
Port	Enter the TCP port number used for Telnet management of the Switch. The “well-known” TCP port for the Telnet protocol is 80.

Click the **Apply** button to accept the changes made.

Session Timeout

This window is used to configure the session timeout.

To view the following window, click **Management > Session Timeout**, as shown below:

Figure 4-22 Session Timeout window

The fields that can be configured are described below:

Parameter	Description
Web Session Timeout	Enter the time in seconds of the web session timeout. Tick the Default

	check box to return to the default setting. The value is from 60 to 36000 seconds. The default value is 180 seconds.
Console Session Timeout	Enter the time in minutes of the web session timeout. Tick the Default check box to return to the default setting. The value is from 0 to 1439 minutes. 0 means never timeout. The default value is 3 minutes.
Telnet Session Timeout	Enter the time in minutes of the Telnet session timeout. Tick the Default check box to return to the default setting. The value is from 0 to 1439 minutes. 0 means never timeout. The default value is 3 minutes.
SSH Session Timeout	Enter the time in minutes of the SSH session timeout. Tick the Default check box to return to the default setting. The value is from 0 to 1439 minutes. 0 means never timeout. The default value is 3 minutes.

Click the **Apply** button to accept the changes made.

DHCP

Service DHCP

This window is used to configure the DHCP relay service on the Switch.

To view the following window, click **Management > DHCP > Service DHCP**, as shown below:

Figure 4-23 Service DHCP window

The fields that can be configured for **Service DHCP** are described below:

Parameter	Description
Service DHCP State	Select this option to enable or disable the DHCP relay service.

Click the **Apply** button to accept the changes made.

The fields that can be configured for **Service IPv6 DHCP** are described below:

Parameter	Description
Service IPv6 DHCP State	Select this option to enable or disable the IPv6 DHCP relay service.

Click the **Apply** button to accept the changes made.

DHCP Class Settings

This window is used to configure and display the DHCP class and the DHCP option matching pattern for the DHCP class.

To view the following window, click **Management > DHCP > Service DHCP**, as shown below:

Figure 4-24 DHCP Class Settings window

The fields that can be configured are described below:

Parameter	Description
Class Name	Enter the DHCP class name with a maximum of 32 characters.

Click the **Apply** button to accept the changes made.

Click the **Edit** button to modify the DHCP option matching pattern for the corresponding DHCP class.

Click the **Delete** button to remove the specified entry.

Enter a page number and click the **Go** button to navigate to a specific page when multiple pages exist.

After clicking the **Edit** button, the following window will appear.

Figure 4-25 DHCP Class Option Settings window

The fields that can be configured are described below:

Parameter	Description
Option	Enter the DHCP option number. The range is from 1 to 255.
Hex	Enter the hex pattern of the specified DHCP option. Tick the * check box not to match the remaining bits of the option.
Bitmask	Enter the hex bit mask for masking of the pattern. The masked pattern bits will be matched. If not specified, all bits entered in Hex will be checked.

Click the **Apply** button to accept the changes made.

Click the **Delete** button to remove the specified entry.

Click the **Back** button to return to the previous window.

DHCP Relay

DHCP Relay Global Settings

This window is used to configure the smart relay feature of the DHCP relay agent.

To view the following window, click **Management > DHCP > DHCP Relay > DHCP Relay Global Settings**, as shown below:

Figure 4-26 DHCP Relay Global Settings window

The fields that can be configured are described below:

Parameter	Description
DCHP Smart Relay State	Select this option to enable or disable the DHCP smart relay.

Click the **Apply** button to accept the changes made.

DHCP Relay Pool Settings

This window is used to configure and display the DHCP relay pool on a DHCP relay agent.

To view the following window, click **Management > DHCP > DHCP Relay > DHCP Relay Pool Settings**, as shown below:

Figure 4-27 DHCP Relay Pool Settings window

The fields that can be configured are described below:

Parameter	Description
Pool Name	Enter the address pool name with a maximum of 32 characters.

Click the **Apply** button to accept the changes made.

Click the **Edit** button to modify the corresponding information of the specific DHCP pool.

Click the **Delete** button to remove the specified entry.

Enter a page number and click the **Go** button to navigate to a specific page when multiple pages exist.

After clicking the **Edit** button under **Source**, the following window will appear.

DHCP Relay Pool Source Settings

DHCP Relay Pool Source Settings

Pool Name: DHCPpool

Source IP Address: 10.90.8.10 Subnet Mask: 255.0.0.0

Total Entries: 1

Source IP Address	Subnet Mask	
10.90.8.10	255.0.0.0	<input type="button" value="Delete"/>

Figure 4-28 DHCP Relay Pool Source Settings window

The fields that can be configured are described below:

Parameter	Description
Source IP Address	Enter the source subnet of client packets.
Subnet Mask	Enter the network mask of the source subnet.

Click the **Apply** button to accept the changes made.

Click the **Delete** button to remove the specified entry.

Click the **Back** button to return to the previous window.

After clicking the **Edit** button under **Destination**, the following window will appear.

DHCP Relay Pool Destination Settings

DHCP Relay Pool Destination Settings

Pool Name: DHCPpool

Relay Destination: 10.90.12.10

Total Entries: 1

Destination	
10.90.12.10	<input type="button" value="Delete"/>

Figure 4-29 DHCP Relay Pool Destination Settings window

The fields that can be configured are described below:

Parameter	Description
Relay Destination	Enter the relay destination DHCP server IP address.

Click the **Apply** button to accept the changes made.

Click the **Delete** button to remove the specified entry.

Click the **Back** button to return to the previous window.

After clicking the **Edit** button under **Class**, the following window will appear.

DHCP Relay Pool Class Settings

DHCP Relay Pool Class Settings

Pool Name: DHCPpool

Class Name: Please Select

Apply

Total Entries: 1

Class Name	
DHCPClass	<input type="button" value="Edit"/> <input type="button" value="Delete"/>

Back

Figure 4-30 DHCP Relay Pool Class Settings window

The fields that can be configured are described below:

Parameter	Description
Class Name	Select the DHCP class name.

Click the **Apply** button to accept the changes made.

Click the **Edit** button to edit more information.

Click the **Delete** button to remove the specified entry.

Click the **Back** button to return to the previous window.

After clicking the **Edit** button, the following window will appear.

DHCP Relay Pool Class Edit Settings

DHCP Relay Pool Class Edit Settings

Pool Name: DHCPpool

Class Name: DHCPClass

Relay Target: . . .

Apply

Total Entries: 1

Target Address	
10.1.2.1	<input type="button" value="Delete"/>

Back

Figure 4-31 DHCP Relay Pool Class Edit Settings window

The fields that can be configured are described below:

Parameter	Description
Relay Target	Enter the DHCP relay target for relaying packets that matches the value pattern of the option defined in the DHCP class.

Click the **Apply** button to accept the changes made.

Click the **Delete** button to remove the specified entry.

Click the **Back** button to return to the previous window.

DHCP Relay Information Settings

This window is used to configure and display the DHCP relay information.

To view the following window, click **Management > DHCP > DHCP Relay > DHCP Relay Information Settings**, as shown below:

Figure 4-32 DHCP Relay Information Settings window

The fields that can be configured are described below:

Parameter	Description
Information Trust All	Select this option to enable or disable the DHCP relay agent to trust the IP DHCP relay information for all interfaces.
Information Check	Select this option to enable or disable the DHCP relay agent to validate and remove the relay agent information option in the received DHCP reply packet.
Information Policy	Select the Option 82 re-forwarding policy for the DHCP relay agent. Options to choose from are Keep , Drop , and Replace . Keep - Select to discard the packet that already has the relay option. Drop - Select that the DHCP request packet that already has the relay option is left unchanged and directly relayed to the DHCP server. Replace - Select that the DHCP request packet that already has the relay option will be replaced by a new option.
Information Option	Select this option to enable or disable the insertion of relay agent information (Option 82) during the relay of DHCP request packets.

Click the **Apply** button to accept the changes made.

Click the **Edit** button to modify the corresponding interface.

Enter a page number and click the **Go** button to navigate to a specific page when multiple pages exist.

DHCP Relay Information Option Format Settings

This window is used to configure and display the DHCP information format.

To view the following window, click **Management > DHCP > DHCP Relay > DHCP Relay Information Option Format Settings**, as shown below:

Figure 4-33 DHCP Relay Information Option Format Settings window

The fields that can be configured for **DHCP Relay Information Option Format Global** are described below:

Parameter	Description
Information Format Remote ID	<p>Select the DHCP information remote ID sub-option. Options to choose from are Default, User Define, Vendor2, and Vendor3.</p> <p>Default - Select to use the Switch's system MAC address as the remote ID.</p> <p>User Define - Select to use a user-defined remote ID. Enter the user-defined string with the maximum of 32 characters in the text box.</p> <p>Vendor2 - Select to use vender 2 as the remote ID.</p> <p>Vendor3 - Select to use vender 3 as the remote ID.</p>
Information Format Circuit ID	<p>Select the DHCP information circuit ID sub-option. Options to choose from are Default, User Define, Vendor1, Vendor2, Vendor3, Vendor4, Vendor5, and Vendor6.</p> <p>Default - Select to use the default circuit ID sub-option.</p> <p>User Define - Select to use a user-defined circuit ID. Enter the user-defined string with the maximum of 32 characters in the text box.</p> <p>Vendor1 - Select to use vender 1 as the circuit ID.</p> <p>Vendor2 - Select to use vender 2 as the circuit ID.</p> <p>Vendor3 - Select to use vender 3 as the circuit ID.</p> <p>Vendor4 - Select to use vender 4 as the circuit ID.</p> <p>Vendor5 - Select to use vender 5 as the circuit ID.</p> <p>Vendor6 - Select to use vender 6 as the circuit ID.</p>

Click the **Apply** button to accept the changes made.

The fields that can be configured for **DHCP Relay Information Option Format Type** are described below:

Parameter	Description
Unit	Select the switch unit that will be used for this configuration here.
From Port / To Port	Select the appropriate port range used for the configuration here.
Format	Select the DHCP information circuit ID format. Option to choose from is Vendor3 .
Type	Select the DHCP information circuit ID format typ. Options to choose from are Remote ID , and Circuit ID .
Value	Enter the vendor-defined string.

Click the **Apply** button to accept the changes made.

DHCP Local Relay VLAN

This window is used to configure local relay on a VLAN or a group of VLANs.

To view the following window, click **Management > DHCP > DHCP Relay > DHCP Local Relay VLAN**, as shown below:

Figure 4-34 DHCP Local Relay VLAN window

The fields that can be configured are described below:

Parameter	Description
DHCP Local Relay VID List	Enter the VLAN ID for DHCP local relay. Tick the All VLANs check box to select all VLANs.
State	Select this option to enable or disable the DHCP local relay on the specific VLAN(s).

Click the **Apply** button to accept the changes made.

DHCPv6 Relay

DHCPv6 Relay Global Settings

This window is used to configure the DHCPv6 relay remote ID.

To view the following window, click **Management > DHCP > DHCPv6 Relay > DHCPv6 Relay Global Settings**, as shown below:

Figure 4-35 DHCPv6 Relay Global Settings window

The fields that can be configured are described below:

Parameter	Description
IPv6 DHCP Relay Remote ID Format	Select to choose the sub-type of the remote ID. Options to choose from are Default , CID with User Define , and User Define .
IPv6 DHCP Relay Remote ID UDF	Select to choose the User Define Field (UDF) for remote ID. Options to choose from are ASCII , and Hex . ASCII - Select to enter the ASCII string with a maximum of 128 characters in the text box. HEX - Select to enter the hexadecimal string with a maximum of 256 characters in the text box.
IPv6 DHCP Relay Remote ID Policy	Select to choose Option 37 forwarding policy for the DHCPv6 relay agent. Options to choose from are Keep , and Drop . Keep - Select to discard the packet that already has the relay agent Remote-ID Option 37. Drop - Select that the DHCPv6 request packet that already has the relay agent Remote-ID option is left unchanged and directly relayed to the DHCPv6 server.
IPv6 DHCP Relay Remote ID Option	Select this option to enable or disable the insertion of the relay agent remote ID Option 37 during the relay of DHCP for IPv6 request packets.

Click the **Apply** button to accept the changes made.

DHCPv6 Relay Interface Settings

This window is used to configure and display the DHCPv6 relay interface settings.

To view the following window, click **Management > DHCP > DHCPv6 Relay > DHCPv6 Relay Interface Settings**, as shown below:

Figure 4-36 DHCPv6 Relay Interface Settings window

The fields that can be configured are described below:

Parameter	Description
Interface VLAN	Enter the VLAN from 1 to 4094 for DHCPv6 relay.
Destination IPv6 Address	Enter the DHCPv6 relay destination address.
Output Interface VLAN	Enter the output interface for the relay destination.

Click the **Apply** button to accept the changes made.

Click the **Find** button to locate a specific entry based on the information entered.

Click the **Delete** button to remove the specified entry.

Enter a page number and click the **Go** button to navigate to a specific page when multiple pages exist.

DHCP Auto Configuration

This window is used to configure the DHCP auto-configuration function.

To view the following window, click **Management > DHCP > DHCP Auto Configuration**, as shown below:

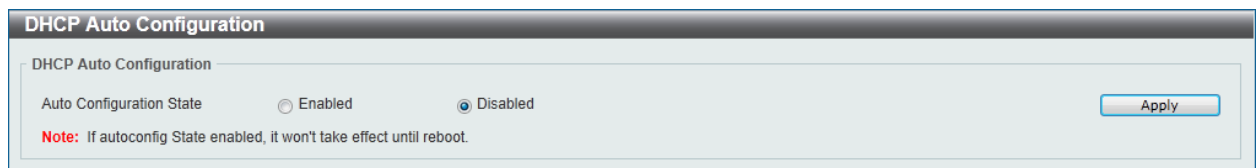

Figure 4-37 DHCP Auto Configuration window

The fields that can be configured are described below:

Parameter	Description
Auto Configuration State	Select this option to enable or disable the auto-configuration function.

Click the **Apply** button to accept the changes made.

DNS

Computer users usually prefer to use text names for computers for which they may want to open a connection. Computers themselves, require 32 bit IP addresses. Somewhere, a database of network devices' text names and their corresponding IP addresses must be maintained.

The Domain Name System (DNS) is used to map names to IP addresses throughout the Internet and has been adapted for use within intranets. For two DNS servers to communicate across different subnets, the DNS Relay of the Switch must be used. The DNS servers are identified by IP addresses.

Mapping Domain Names to Addresses

Name-to-address translation is performed by a program called a Name server. The client program is called a Name resolver. A Name resolver may need to contact several Name servers to translate a name to an address.

The Domain Name System (DNS) servers are organized in a somewhat hierarchical fashion. A single server often holds names for a single network, which is connected to a root DNS server - usually maintained by an ISP.

Domain Name Resolution

The domain name system can be used by contacting the name servers one at a time, or by asking the domain name system to do the complete name translation. The client makes a query containing the name, the type of answer required, and a code specifying whether the domain name system should do the entire name translation, or simply return the address of the next DNS server if the server receiving the query cannot resolve the name.

When a DNS server receives a query, it checks to see if the name is in its sub domain. If it is, the server translates the name and appends the answer to the query, and sends it back to the client. If the DNS server cannot translate the name, it determines what type of name resolution the client requested. A complete translation is called recursive resolution and requires the server to contact other DNS servers until the name is resolved. Iterative resolution specifies that if the DNS server cannot supply an answer, it returns the address of the next DNS server the client should contact.

Each client must be able to contact at least one DNS server, and each DNS server must be able to contact at least one root server.

The address of the machine that supplies domain name service is often supplied by a DHCP or BOOTP server, or can be entered manually and configured into the operating system at startup.

DNS Global Settings

This window is used to configure the DNS global settings.

To view the following window, click **Management > DNS > DNS Global Settings**, as shown below:

Figure 4-38 DNS Global Settings window

The fields that can be configured are described below:

Parameter	Description
IP Domain Lookup	Select this option to enable or disable the DNS to carry out the domain name resolution.
IP Name Server Timeout	Enter the maximum time to wait for a response from a specified name server. This value is between 1 and 60 seconds.

Click the **Apply** button to accept the changes made.

DNS Name Server Settings

This window is used to configure and display the IP address of a domain name server.

To view the following window, click **Management > DNS > DNS Name Server Settings**, as shown below:

Figure 4-39 DNS Name Server Settings window

The fields that can be configured are described below:

Parameter	Description
Name Server IPv4	Select and enter the IPv4 address of the DNS server.
Name Server IPv6	Select and enter the IPv6 address of the DNS server.

Click the **Apply** button to accept the changes made.

Click the **Delete** button to remove the specified entry.

DNS Host Settings

This window is used to configure the static mapping entry for the host name and the IP address in the host table.

To view the following window, click **Management > DNS > DNS Host Settings**, as shown below:

Figure 4-40 DNS Host Settings window

The fields that can be configured are described below:

Parameter	Description
Host Name	Enter the host name of the equipment.
IP Address	Select and enter the IPv4 address of the equipment.

IPv6 Address	Select and enter the IPv6 address of the equipment.
---------------------	---

Click the **Apply** button to accept the changes made.

Click the **Delete** button to remove the specified entry.

IP Source Interface

This window is used to configure the IP source interface settings.

To view the following window, click **Management > IP Source Interface**, as shown below:

Figure 4-41 IP Source Interface window

The fields that can be configured are described below:

Parameter	Description
Source Interface State	Select to Enable or Disable the source interface feature's global state here.
Interface Type	After enabling the Source Interface State option, select the interface type here. The only option available is VLAN .
VID (1-4094)	After selecting the VLAN as the Interface Type , enter the VLAN ID used here. This value must be between 1 and 4094.

Click the **Apply** button to accept the changes made.

File System

Why use flash file system:

In old switch system, the firmware, configuration and log information are saved in a flash with fixed addresses and size. This means that the maximum configuration file can only be 2Mb, and even if the current configuration is only 40Kb, it will still take up 2Mb of flash storage space. The configuration file number and firmware numbers are also fixed. A compatible issue will occur in the event that the configuration file or firmware size exceeds the originally designed size.

Flash File System in our system:

The Flash File System is used to provide the user with flexible file operation on the Flash. All the firmware, configuration information and system log information are stored in the Flash as files. This means that the Flash space taken up by all the files are not fixed, it is the real file size. If the Flash space is enough, the user could download more configuration files or firmware files and use commands to display Flash file information, rename file names, and delete it. Furthermore, the user can also configure the **boot up runtime image** or the **running configuration file** if needed.

To view this window, click **Management > File System** as shown below:

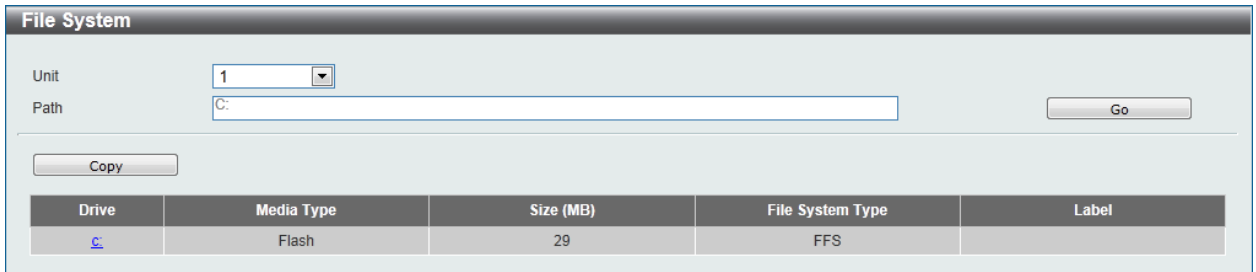

Figure 4-42 File System window

The fields that can be configured are described below:

Parameter	Description
Unit	Select the switch unit that will be used for this configuration here.
Path	Enter the path string

Click the **Go** button to navigate to the path entered.

Click the [C:](#) hyperlink to navigate the C: drive

After clicking the [C:](#) hyperlink, the following window will appear:

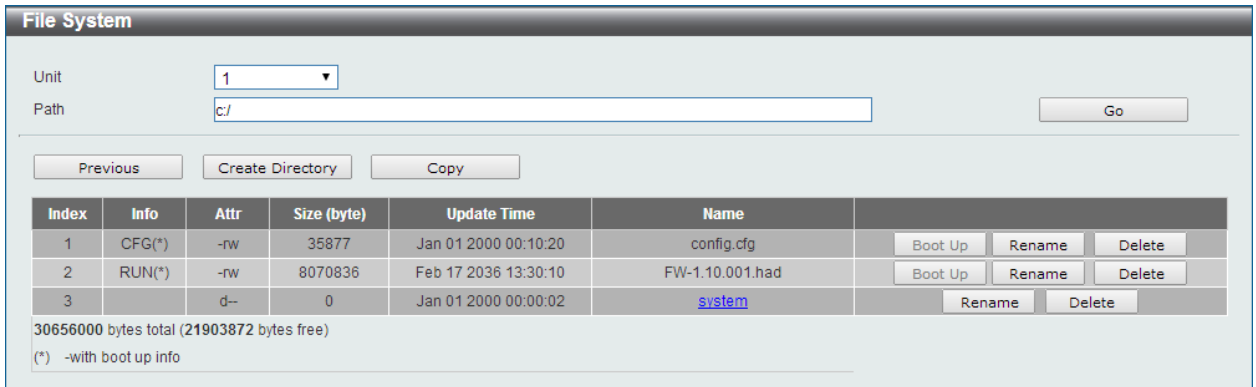

Figure 4-43 File System - Search for Drive window

Click the **Previous** button to return to the previous window.

Click the **Create Directory** to create a new directory within the file system of the Switch.

Click the **Copy** button to copy a specific file to the Switch.

Click the **Boot Up** button to set a specific runtime image as the boot up image.

Click the **Rename** button to rename a specific file's name.

Click the **Delete** button to remove a specific file from the file system.

Click the **Copy** button to see the following window.

Figure 4-44 File System - Copy window

When copying a file to the file system of this switch, the user must enter the **Source** and **Destination** path. Tick the **Replace** check box to replace the current running configuration with the indicated configuration file.

Click the **Apply** button to initiate the copy.

Click the **Cancel** button to discard the process.

Physical Stacking

The Switch supports switch stacking, where a set of 6 switches can be combined to be managed by one IP address through Telnet, the Web User Interface, the RJ45 console port, or through SNMP. Each switch of this series has two stacking ports located at the front of the device, which can be used to connect other devices and make them stack together. After adding these stacking ports, the user may connect these ports together using fiber cables or Direct Attach Cables (DAC) in one of two possible topologies.

Duplex Chain – As shown in Figure 4-45, The Duplex Chain topology stacks switches together in a chain-link format. Using this method, data transfer is only possible in one direction and if there is a break in the chain, then data transfer will obviously be affected.

Duplex Ring – As shown in **Error! Reference source not found.**, the Duplex Ring stacks switches in a ring or circle format where data can be transferred in two directions. This topology is very resilient due to the fact that if there is a break in the ring, data can still be transferred through the stacking cables between switches in the stack.

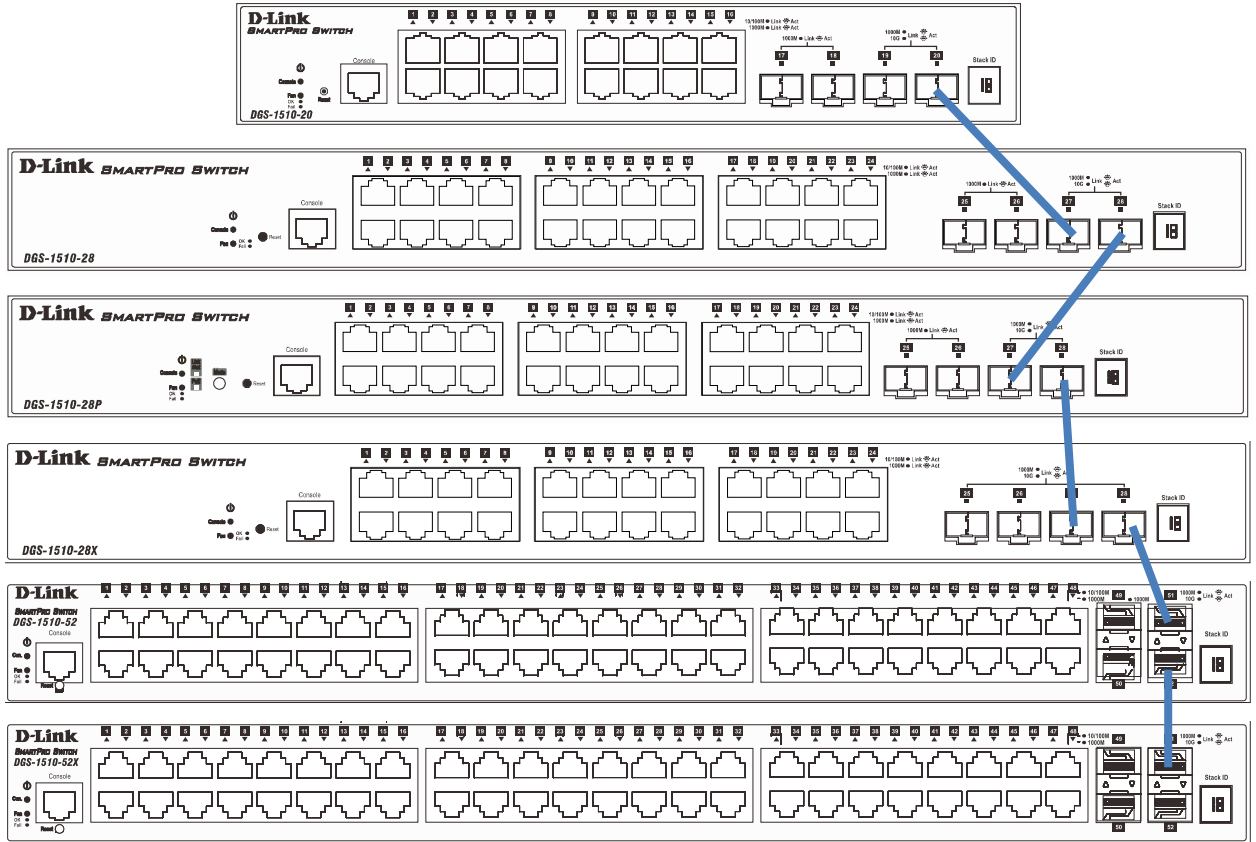

Figure 4-45 Switches stacked in a Duplex Chain

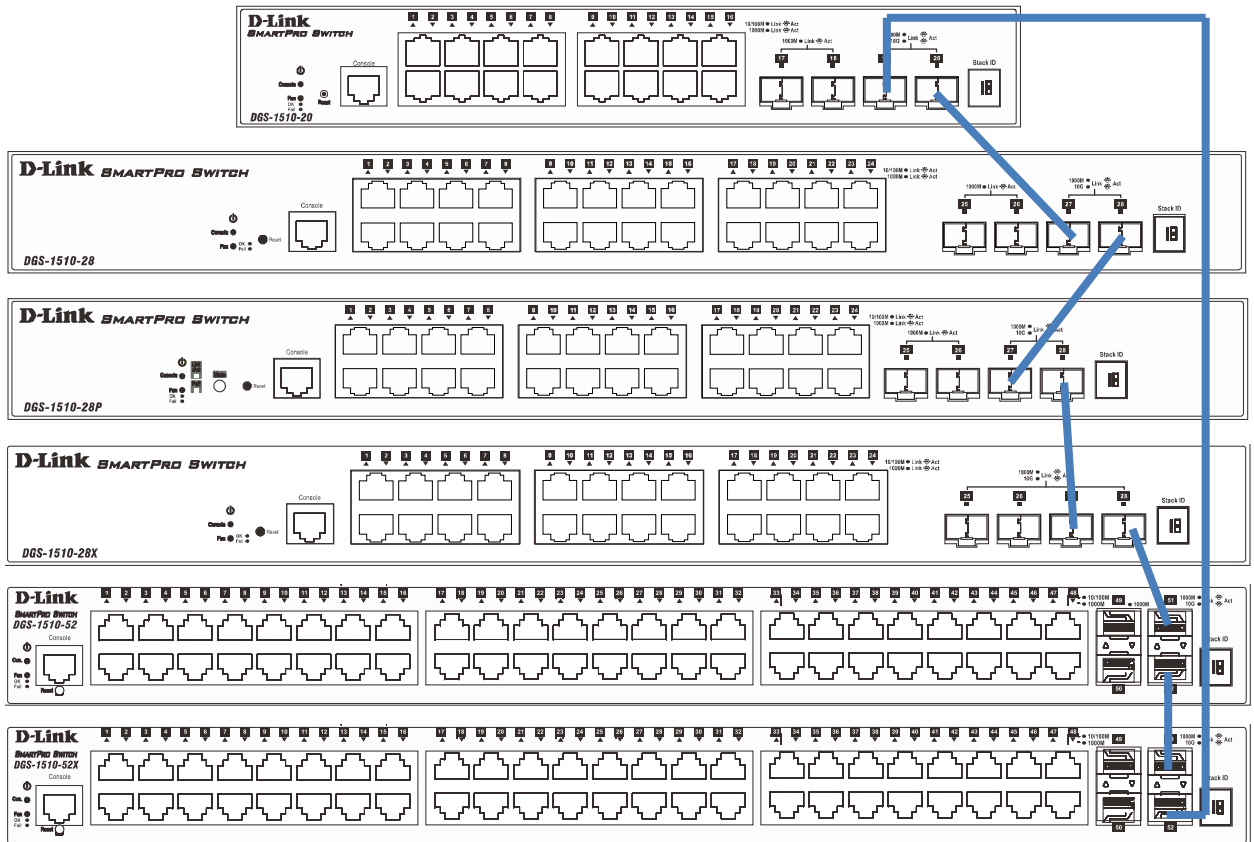

Figure 4-46 Switches stacked in a Duplex Ring

Within each of these topologies, each switch plays a role in the Switch stack. These roles can be set by the user per individual Switch, or if desired, can be automatically determined by the Switch stack. Three possible roles exist when stacking with the Switch.

Primary Master – The Primary Master is the leader of the stack. It will maintain normal operations, monitor operations and the running topology of the Stack. This switch will also assign Stack Unit IDs, synchronize configurations and transmit commands to remaining switches in the switch stack. The Primary Master can be manually set by assigning this Switch the highest priority (a lower number denotes a higher priority) before physically assembling the stack, or it can be determined automatically by the stack through an election process which determines the lowest MAC address and then will assign that switch as the Primary Master, if all priorities are the same. The Primary master are physically displayed by the seven segment LED to the far right on the front panel of the switch where this LED will flash between its given Box ID and 'H'.

Backup Master – The Backup Master is the backup to the Primary Master, and will take over the functions of the Primary Master if the Primary Master fails or is removed from the Stack. It also monitors the status of neighboring switches in the stack, will perform commands assigned to it by the Primary Master and will monitor the running status of the Primary Master. The Backup Master can be set by the user by assigning this Switch the second highest priority before physically assembling the stack, or it can be determined automatically by the stack through an election process which determines the second lowest MAC address and then will assign that switch as the Backup Master, if all priorities are the same. The Backup master are physically displayed by the seven segment LED to the far right on the front panel of the switch where this LED will flash between its given Box ID and 'h'.

Slave – Slave switches constitute the rest of the switch stack and although not Primary or Backup Masters, they can be placed into these roles when these other two roles fail or are removed from the stack. Slave switches perform operations requested by the master, monitor the status of neighbor switches in the stack and the stack topology and adhere to the Backup Master's commands once it becomes a Primary Master. Slave switches will do a self-check to determine if it is to become the Backup

Master if the Backup Master is promoted to the Primary Master, or if the Backup Master fails or is removed from the switch stack. If both Primary and Backup masters fail, or are removed from the Switch stack, it will determine if it is to become the Primary Master. These roles will be determined, first by priority and if the priority is the same, the lowest MAC address.

Once switches have been assembled in the topology desired by the user and powered on, the stack will undergo three processes until it reaches a functioning state.

Initialization State – This is the first state of the stack, where the runtime codes are set and initialized and the system conducts a peripheral diagnosis to determine each individual switch is functioning properly.

Master Election State – Once the codes are loaded and initialized, the stack will undergo the Master Election State where it will discover the type of topology used, elect a Primary Master and then a Backup Master.

Synchronization State – Once the Primary Master and the Backup Master have been established, the Primary Master will assign Stacking Unit IDs to switches in the stack, synchronize configurations for all switches and then transmit commands to the rest of the switches based on the users configurations of the Primary Master.

Once these steps have been completed, the switch stack will enter a normal operating mode.

Stack Switch Swapping

The stacking feature of the Switch supports “hot swapping” of switches in and out of the running stack. Users may remove or add switches to the stack without powering down or largely affecting the transfer of data between switches in the stack, with a few minor provisions.

When switches are “hot inserted” into the running stack, the new switch may take on the Primary Master, Backup Master or Slave role, depending on configurations set on the newly added switch, such as configured priority or MAC address. Yet, if adding two stacks together that have both previously undergone the election process, and therefore both have a Primary Master and a Backup master, a new Primary Master will be elected from one of the already existing Primary Masters, based on priority or MAC address. This Primary Master will take over all of the Primary Master’s roles for all new switches that were hot inserted. This process is done using discovery packets that circulate through the switch stack every 1.5 seconds until the discovery process has been completed.

The “hot remove” action means removing a device from the stack while the stack is still running. The hot removal is detected by the stack when it fails to receive heartbeat packets during its specified interval from a device, or when one of the stacking ports links is down. Once the device has been removed, the remaining switches will update their stacking topology database to reflect the change. Any one of the three roles, Primary Master, Backup Master or Slave, may be removed from the stack, yet different processes occur for each specific device removal.

If a Slave device has been removed, the Primary Master will inform other switches of the hot remove of this device through the use of unit leave messages. Switches in the stack will clear the configurations of the unit removed, and dynamically learned databases, such as ARP, will be cleared as well.

If the Backup Master has been hot removed, a new Backup Master will be chosen through the election process previously described. Switches in the stack will clear the configurations of the unit removed, and dynamically learned databases, such as ARP, will be cleared as well. Then the Backup Master will begin backing up the Primary Master when the database synchronization has been completed by the stack.

If the Primary Master is removed, the Backup Master will assume the Primary Master’s role and a new Backup Master will be chosen using the election process. Switches in the stack will clear the configurations of the unit removed, and dynamically learned databases, such as ARP, will be cleared as well. The new Primary Master will inherit the MAC and IP address of the previous Primary Master to avoid conflict within the stack and the network itself.

If both the Primary Master and the Backup Master are removed, the election process is immediately processed, and a new Primary Master and Backup Master are determined. Switches in the stack will clear the configurations of the units removed, and dynamically learned databases, such as ARP, will be cleared as well. Static switch configurations still remain in the database of the remaining switches in the stack and those functions will not be affected.



NOTE: If there is a Box ID conflict when the stack is in the discovery phase, the device will enter a special standalone topology mode. Users can only get device information, configure Box IDs, save and reboot. All stacking ports will be disabled and an error message will be produced on the local console port of each device in the stack. Users must reconfigure Box IDs and reboot the stack.

Physical Stacking

Physical Stacking

Stacking Mode Enabled Disabled Apply

Stack Preempt Enabled Disabled Apply

Trap State Enabled Disabled

Stack ID

Current Unit ID New Box ID Priority (1-63) Apply

Topology: Duplex_Chain My Box ID: 1
Master ID: 1 BK Master ID: -
Box Count: 1

Box ID	User Set	Module Name	Exist	Priority	MAC	PROM Version	Runtime Version	H/W Version
1	Auto	DGS-1510-28P	Exist	32	00-01-02-03-04-00	1.00.009	1.10.001	A1
2	-	NOT_EXIST	No	-	-	-	-	-
3	-	NOT_EXIST	No	-	-	-	-	-
4	-	NOT_EXIST	No	-	-	-	-	-
5	-	NOT_EXIST	No	-	-	-	-	-
6	-	NOT_EXIST	No	-	-	-	-	-

Figure 4-47 Physical Stacking window

The fields that can be configured for **Physical Stacking** are described below:

Parameter	Description
Stacking Mode	Select this option to enable or disable the stacking mode.
Stack Preempt	Select this option to enable or disable preemption of the master role to come into play when a unit with a better priority is added to the Switch later.
Trap State	Select this option to enable or disable sending of stacking related traps.

Click the **Apply** button to accept the changes made.

The fields that can be configured for **Stack ID** are described below:

Parameter	Description
Current Unit ID	Select the unit ID of the switch in the stack.
New Box ID	Select the new box ID for the switch that is selected in the Current Unit ID . The user may choose any number between 1 and 6 to identify the switch in the switch stack. Auto will automatically assign a box number to the switch in the switch stack.
Priority	Enter the priority of the switch stacking unit. The range is from 1 to 63.

Click the **Apply** button to accept the changes made.

Virtual Stacking (SIM)

D-Link Single IP Management (SIM) is a concept that will stack switches together over Ethernet instead of using stacking ports or modules. There are some advantages in implementing the Single IP Management feature:

1. SIM can simplify management of small workgroups or wiring closets while scaling the network to handle increased bandwidth demand.
2. SIM can reduce the number of IP address needed in your network.
3. SIM can eliminate any specialized cables for stacking connectivity and remove the distance barriers that typically limit your topology options when using other stacking technology.

Switches using D-Link Single IP Management (labeled here as SIM) must conform to the following rules:

- SIM is an optional feature on the Switch and can easily be enabled or disabled through the Command Line Interface or Web Interface. SIM grouping has no effect on the normal operation of the Switch in the user's network.
- There are three classifications for switches using SIM. The **Commander Switch (CS)**, which is the master switch of the group, **Member Switch (MS)**, which is a switch that is recognized by the CS as a member of a SIM group, and a **Candidate Switch (CaS)**, which is a Switch that has a physical link to the SIM group but has not been recognized by the CS as a member of the SIM group.
- A SIM group can only have one Commander Switch (CS).
- A SIM group accepts up to 32 switches (numbered 1-32), not including the Commander Switch (numbered 0).
- Members of a SIM group cannot cross a router.
- There is no limit to the number of SIM groups in the same IP subnet (broadcast domain); however a single switch can only belong to one group.
- If multiple VLANs are configured, the SIM group will only utilize the management VLAN on any switch.
- SIM allows intermediate devices that do not support SIM. This enables the user to manage switches that are more than one hop away from the CS.

The SIM group is a group of switches that are managed as a single entity. The Switch may take on three different roles:

1. **Commander Switch (CS)** – This is a switch that has been manually configured as the controlling device for a group, and takes on the following characteristics:
 - a. It has an IP Address.
 - b. It is not a command switch or member switch of another Single IP group.
 - c. It is connected to the member switches through its management VLAN.
2. **Member Switch (MS)** – This is a switch that has joined a single IP group and is accessible from the CS, and it takes on the following characteristics:
 - a. It is not a CS or MS of another IP group.
 - b. It is connected to the CS through the CS management VLAN.
3. **Candidate Switch (CaS)** – This is a switch that is ready to join a SIM group but is not yet a member of the SIM group. The Candidate Switch may join the SIM group of the Switch by manually configuring it to be a MS of a SIM group. A switch configured as a CaS is not a member of a SIM group and will take on the following characteristics:
 - a. It is not a CS or MS of another Single IP group.
 - b. It is connected to the CS through the CS management VLAN

The following rules also apply to the above roles:

- Each device begins in a Candidate state.
- A CS must change its role to CaS and then to MS, to become a MS of a SIM group. Thus, the CS cannot directly be converted to a MS.

- The user can manually configure a CS to become a CaS.
- A MS can become a CaS by:
 - Being configured as a CaS through the CS.
 - If report packets from the CS to the MS time out.
- The user can manually configure a CaS to become a CS
- The CaS can be configured through the CS to become a MS.

After configuring one switch to operate as the CS of a SIM group, additional DGS-1510 Series switches may join the group by manually configuring the Switch to be a MS. The CS will then serve as the in band entry point for access to the MS. The CS's IP address will become the path to all MS's of the group and the CS's Administrator's password, and/or authentication will control access to all MS's of the SIM group.

With SIM enabled, the applications in the CS will redirect the packet instead of executing the packets. The applications will decode the packet from the administrator, modify some data, and then send it to the MS. After execution, the CS may receive a response packet from the MS, which it will encode and send it back to the administrator.

When a CaS becomes a MS, it automatically becomes a member of the first SNMP community (includes read/write and read only) to which the CS belongs. However, if a MS has its own IP address, it can belong to SNMP communities to which other switches in the group, including the CS, do not belong.

Upgrade to v1.61

To better improve SIM management, the DGS-1510 Series switches have been upgraded to version 1.61 in this release. Many improvements have been made, including:

1. The Commander Switch (CS) now has the capability to automatically rediscover member switches that have left the SIM group, either through a reboot or web malfunction. This feature is accomplished through the use of Discover packets and Maintenance packets that previously set SIM members will emit after a reboot. Once a MS has had its MAC address and password saved to the CS's database, if a reboot occurs in the MS, the CS will keep this MS information in its database and when a MS has been rediscovered, it will add the MS back into the SIM tree automatically. No configuration will be necessary to rediscover these switches.

There are some instances where pre-saved MS switches cannot be rediscovered. For example, if the Switch is still powered down, if it has become the member of another group, or if it has been configured to be a Commander Switch, the rediscovery process cannot occur.

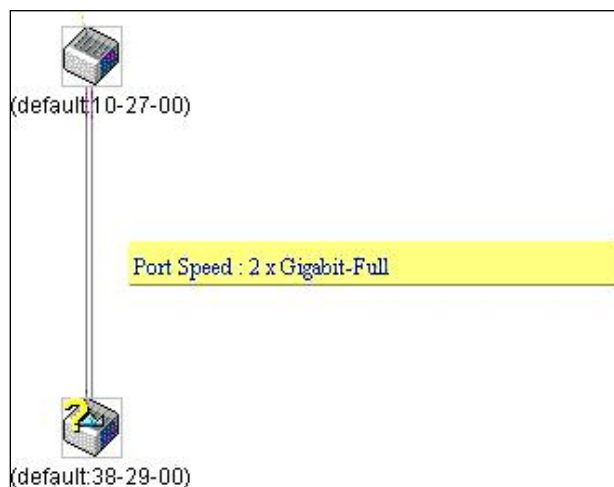

2. The topology map now includes new features for connections that are a member of a port trunking group. It will display the speed and number of Ethernet connections creating this port trunk group, as shown in the adjacent picture.

3. This version will support switch upload and downloads for firmware, configuration files and log files, as follows:
 - a. **Firmware** – The switch now supports MS firmware downloads from a TFTP server.
 - b. **Configuration Files** – This switch now supports downloading and uploading of configuration files both to (for configuration restoration) and from (for configuration backup) MS's, using a TFTP server.
 - c. **Log** – The Switch now supports uploading MS log files to a TFTP server.
4. The user may zoom in and zoom out when utilizing the topology window to get a better, more defined view of the configurations.

Single IP Settings

This window is used to configure the SIM settings. The Switch is set as a Candidate (CaS) as the factory default configuration and Single IP Management is disabled.

To view the following window, click **Management > Virtual Stacking (SIM) > Single IP Settings**, as shown below:

Figure 4-48 Single IP Settings window

The fields that can be configured for **SIM State Configure** are described below:

Parameter	Description
SIM State	Select this option to enable or disable the SIM state on the Switch. Select Disabled to render all SIM functions on the Switch inoperable.

Click the **Apply** button to accept the changes made.

The fields that can be configured for **SIM Role Configure** are described below:

Parameter	Description
Role State	<p>Select to change the SIM role of the Switch. Options to choose from are Candidate, and Commander.</p> <p>Candidate - A Candidate Switch (CaS) is not the member of a SIM group but is connected to a Commander Switch. This is the default setting for the SIM role of the Switch.</p> <p>Commander – Select to make the Switch a Commander Switch (CS). The user may join other switches to this Switch, over Ethernet, to be part of its SIM group. Choosing this option will also enable the Switch to be configured for SIM.</p>

Group Name	Enter a group name. This is optional. This name is used to segment switches into different SIM groups.
-------------------	--

Click the **Apply** button to accept the changes made.

The fields that can be configured for **SIM Settings** are described below:

Parameter	Description
Traps State	Select to enable or disable the SIM trap state.
Interval	Enter the interval in seconds. The range is from 30 to 90.
Hold Time	Enter the hold-time in seconds. The range is from 100 to 255.
Management VLAN	Enter the single IP management message VLAN ID.

Click the **Apply** button to accept the changes made.

After enabling the Switch to be a Commander Switch (CS), the **Single IP Management** folder will then contain four added links to aid the user in configuring SIM through the web, including **Topology**, **Firmware Upgrade**, **Configuration Backup/Restore** and **Upload Log File**.

Topology

This window is used to configure and manage the Switch within the SIM group and requires Java script to function properly on your computer.

To view the following window, click **Management > Virtual Stacking (SIM) > Topology**, as shown below:

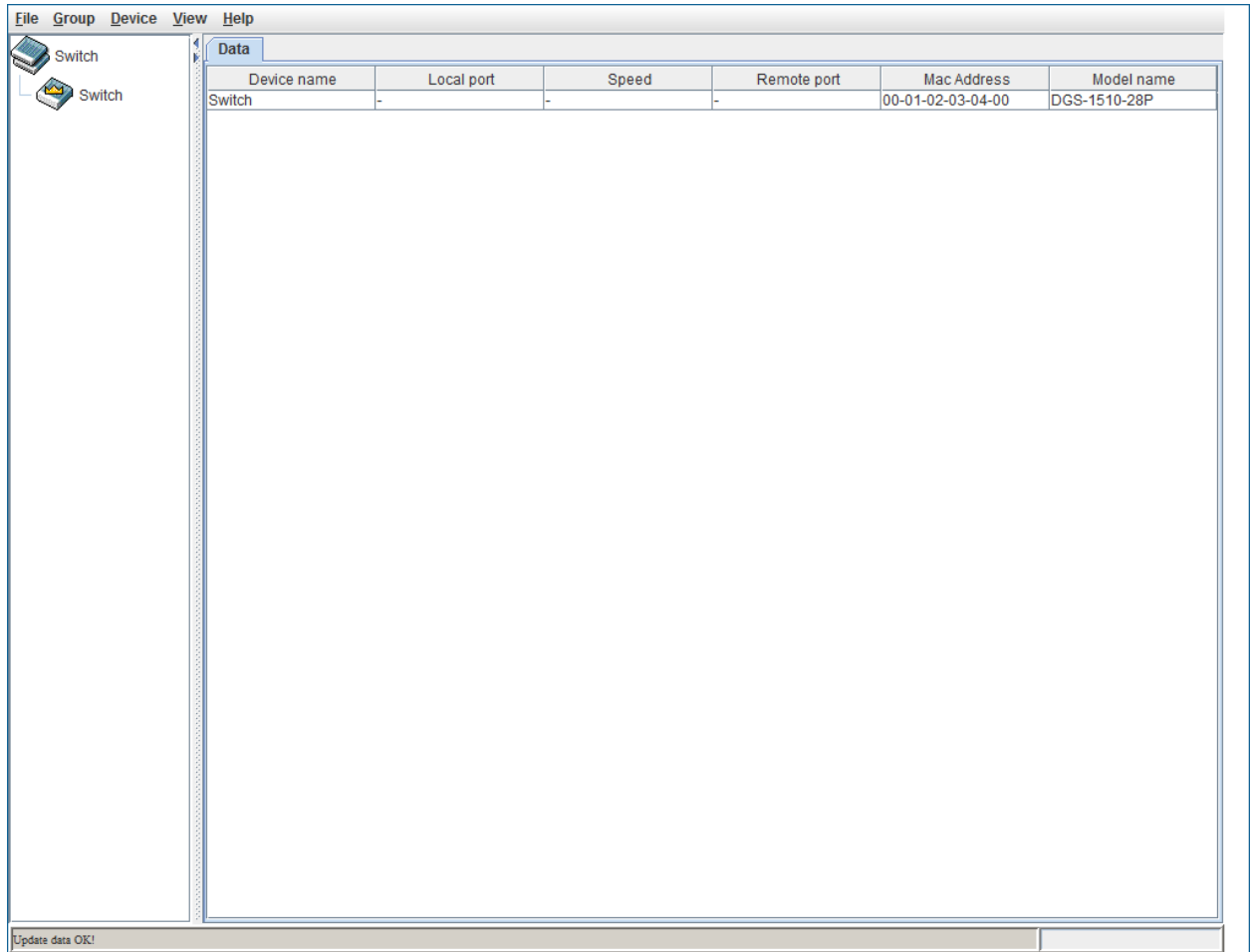

Figure 4-49 Single IP Management window - Tree View

The fields that can be displayed are described below:

Parameter	Description
Device Name	Display the Device Name of the switches in the SIM group configured by the user. If no device is configured by the name, it will be given the name default and tagged with the last six digits of the MAC Address to identify it.
Local Port	Display the number of the physical port on the CS that the MS or CaS is connected to. The CS will have no entry in this field.
Speed	Display the connection speed between the CS and the MS or CaS.
Remote Port	Display the number of the physical port on the MS or CaS to which the CS is connected. The CS will have no entry in this field.
MAC Address	Display the MAC Address of the corresponding Switch.
Model Name	Display the full Model Name of the corresponding Switch.

To view the Topology View window, open the **View** drop-down menu in the toolbar and then click **Topology**, which will open the following Topology Map. This window will refresh itself periodically (20 seconds by default).

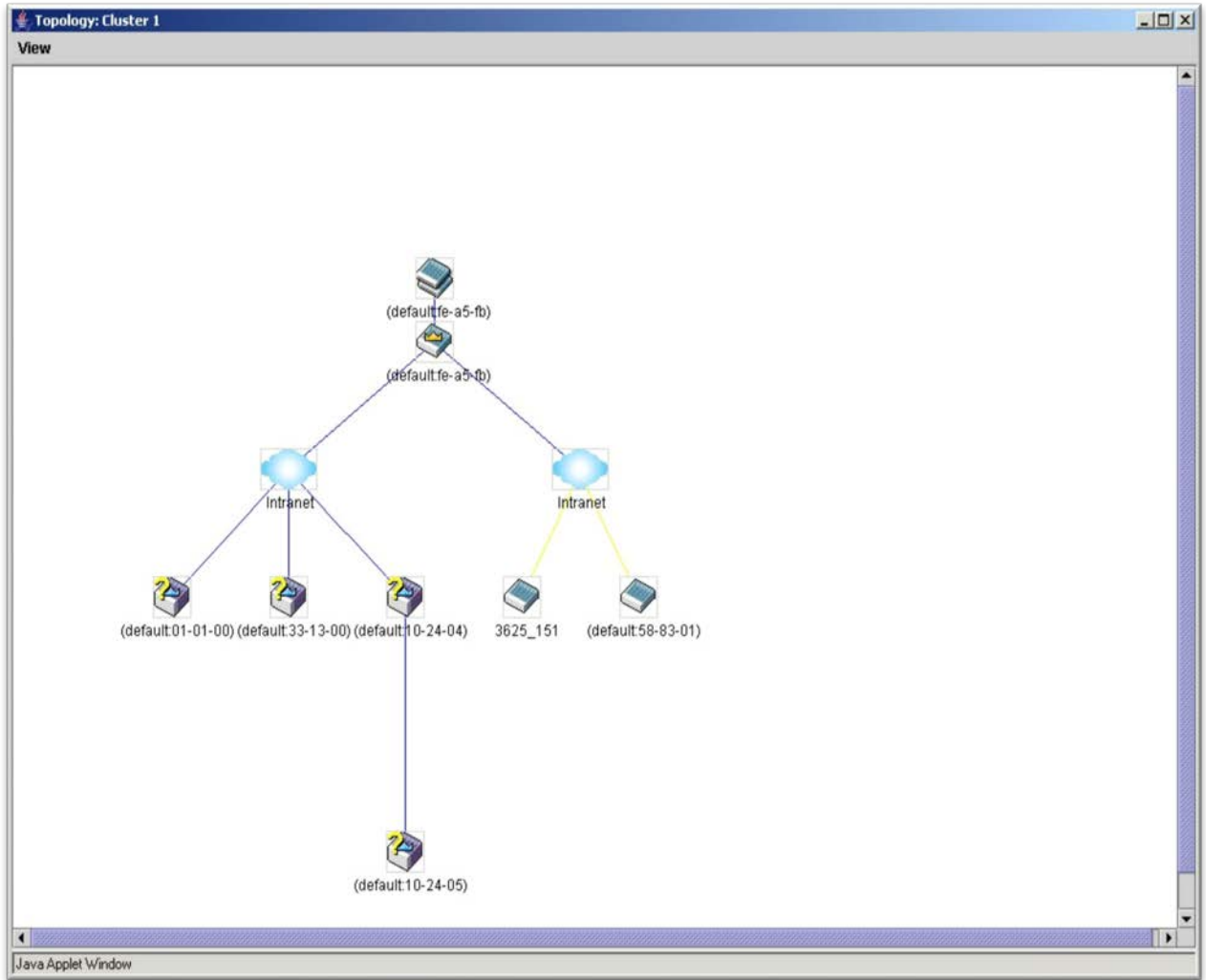













Figure 4-50 Topology view

This window will display how the devices within the Single IP Management Group connect to other groups and devices. Possible icons on this window are as follows:

Icon	Description	Icon	Description
	Group		Layer 3 member switch
	Layer 2 commander switch		Member switch of other group
	Layer 3 commander switch		Layer 2 candidate switch
	Commander switch of other group		Layer 3 candidate switch
	Layer 2 member switch		Unknown device
	Non-SIM devices		

Tool Tips

In the Topology view window, the mouse plays an important role in configuration and in viewing device information. Setting the mouse cursor over a specific device in the topology window (tool tip) will display the same information about a specific device as the Tree view does. See the window below for an example.

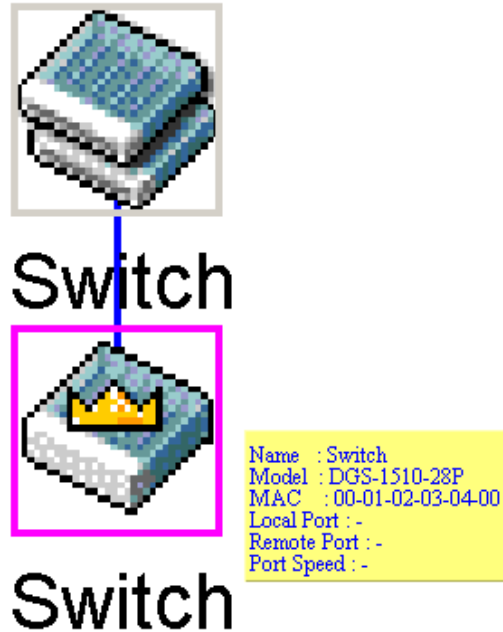

Figure 4-51 Device Information Utilizing the Tool Tip

Setting the mouse cursor over a line between two devices will display the connection speed between the two devices, as shown below.

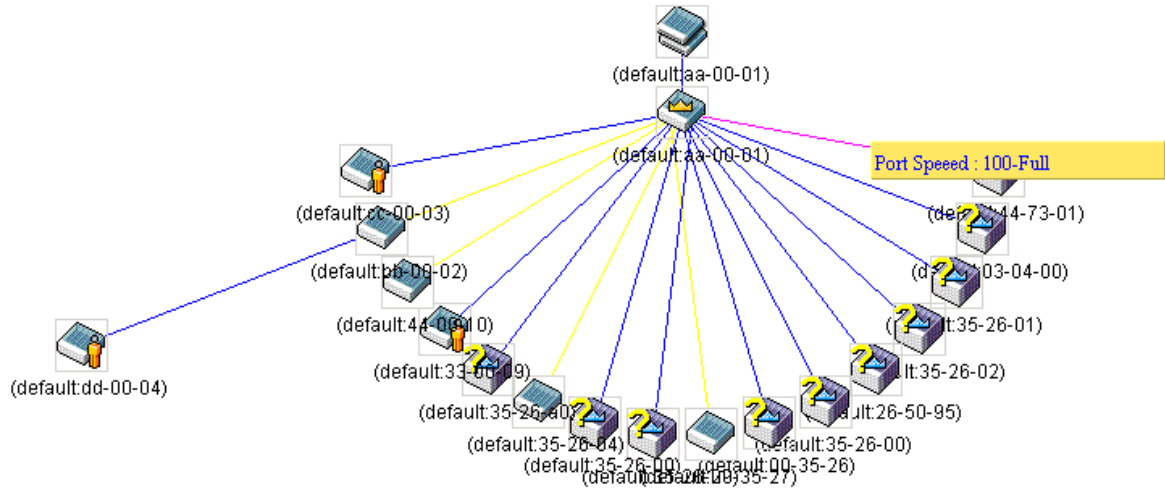

Figure 4-52 Port Speed Utilizing the Tool Tip

Right-Click

Right-clicking on a device will allow the user to perform various functions, depending on the role of the Switch in the SIM group and the icon associated with it.

Group Icon

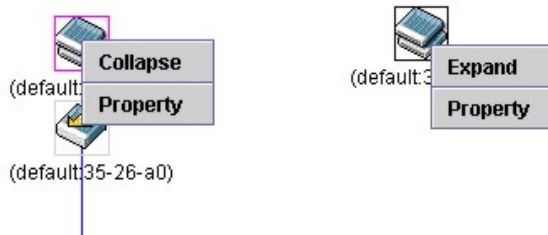

Figure 4-53 Right-Clicking a Group Icon

The following options may appear for the user to configure:

- **Collapse** - To collapse the group that will be represented by a single icon.
- **Expand** - To expand the SIM group, in detail.
- **Property** - To pop up a window to display the group information.

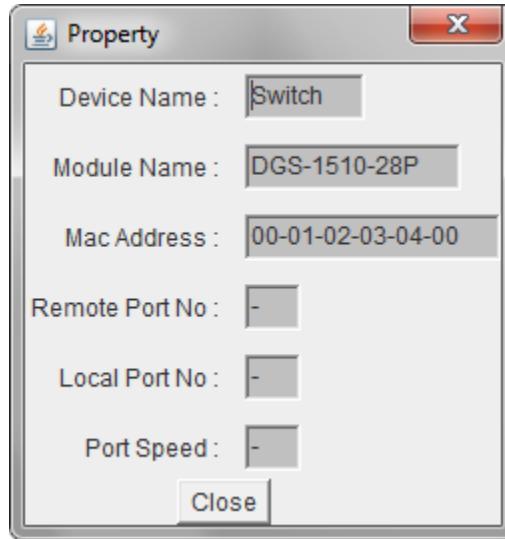

Figure 4-54 Property window

The fields that can be displayed are described below:

Parameter	Description
Device Name	Display the Device Name of the switches in the SIM group configured by the user. If no Device Name is configured by the name, it will be given the name default and tagged with the last six digits of the MAC Address to identify it.
Module Name	Display the full module name of the switch that was right-clicked.
MAC Address	Display the MAC Address of the corresponding Switch.
Remote Port No	Display the number of the physical port on the MS or CaS that the CS is connected to. The CS will have no entry in this field.
Local Port No	Display the number of the physical port on the CS that the MS or CaS is connected to. The CS will have no entry in this field.
Port Speed	Display the connection speed between the CS and the MS or CaS.

Click the **Close** button to close the property window.

Commander Switch Icon

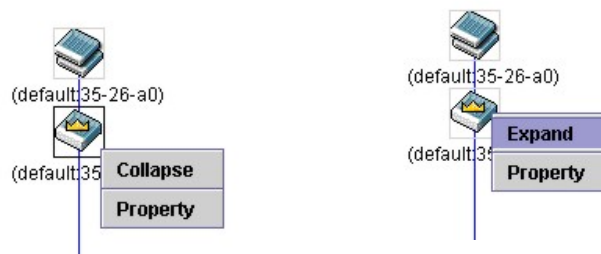

Figure 4-55 Right-clicking a Commander Icon

The following options may appear for the user to configure:

- **Collapse** - To collapse the group that will be represented by a single icon.
- **Expand** - To expand the SIM group, in detail.
- **Property** - To pop up a window to display the group information.

Member Switch Icon

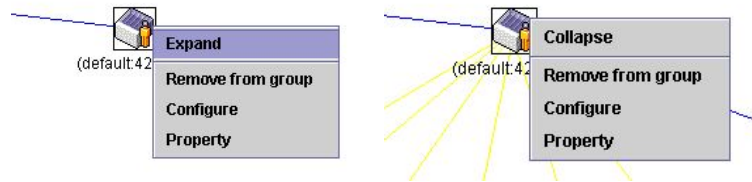

Figure 4-56 Right-clicking a Member icon

The following options may appear for the user to configure:

- **Collapse** - To collapse the group that will be represented by a single icon.
- **Expand** - To expand the SIM group, in detail.
- **Remove from group** - Remove a member from a group.
- **Configure** - Launch the web management to configure the Switch.
- **Property** - To pop up a window to display the device information.

Candidate Switch Icon

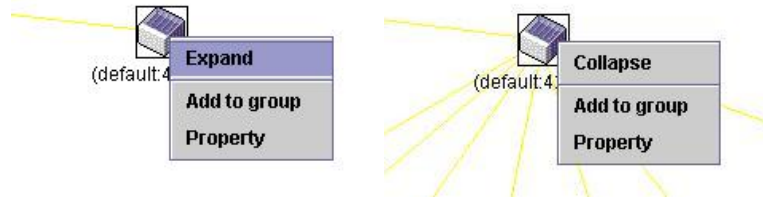

Figure 4-57 Right-clicking a Candidate icon

The following options may appear for the user to configure:

- **Collapse** - To collapse the group that will be represented by a single icon.
- **Expand** - To expand the SIM group, in detail.
- **Add to group** - Add a candidate to a group. Clicking this option will reveal the following dialog box for the user to enter a password for authentication from the Candidate Switch before being added to the SIM group. Click **OK** to enter the password or **Cancel** to exit the dialog box.



Figure 4-58 Input password window

- **Property** - To pop up a window to display the device information.

Menu Bar

The Single IP Management window contains a menu bar for device configurations, as seen below.



Figure 4-59 Menu Bar of the Topology View

File

- **Print Setup** - Will view the image to be printed.
- **Print Topology** - Will print the topology map.
- **Preference** - Will set display properties, such as polling interval, and the views to open at SIM startup.

Group

- **Add to group** - Add a candidate to a group. Clicking this option will reveal the following dialog box for the user to enter a password for authentication from the Candidate Switch before being added to the SIM group. Click **OK** to enter the password or **Cancel** to exit the dialog box.



Figure 4-60 Input password window

- **Remove from group** - Remove an MS from the group.

Device

- **Configure** - Will open the Web manager for the specific device.

View

- **Refresh** - Update the views with the latest status.
- **Topology** - Display the Topology view.

Help

- **About** - Will display the SIM information, including the current SIM version.



Figure 4-61 About window

Firmware Upgrade

This window is used to upgrade firmware from the Commander Switch to the Member Switch. Member Switches will be listed in the table

To view the following window, click **Management > Virtual Stacking (SIM) > Firmware Upgrade**, as shown below:

Figure 4-62 Firmware Upgrade window

The fields that can be configured are described below:

Parameter	Description
TFTP Server IP	Enter the TFTP server IP address.
Path\Filename	Enter the path and file name.

Click the **Download** button to update the firmware.

To specify a certain Switch for firmware download, tick its corresponding check box.

Configuration File Backup/Restore

This window is used to upgrade configuration files from the Commander Switch to the Member Switch using a TFTP server. Member Switches will be listed in the table.

To view the following window, click **Management > Virtual Stacking (SIM) > Configuration File Backup/Restore**, as shown below:

Figure 4-63 Configuration File Backup/Restore window

The fields that can be configured are described below:

Parameter	Description
TFTP Server IP	Enter the TFTP server IP address.
Path\Filename	Enter the path and file name.

Click the **Restore** button to update the configuration from a TFTP server to the member switch.

Click the **Backup** button to back up the configuration file to a TFTP server.

Upload Log File

This window is used to upload log files from SIM member switches to a specified PC.

To view the following window, click **Management > Virtual Stacking (SIM) > Upload Log File**, as shown below:

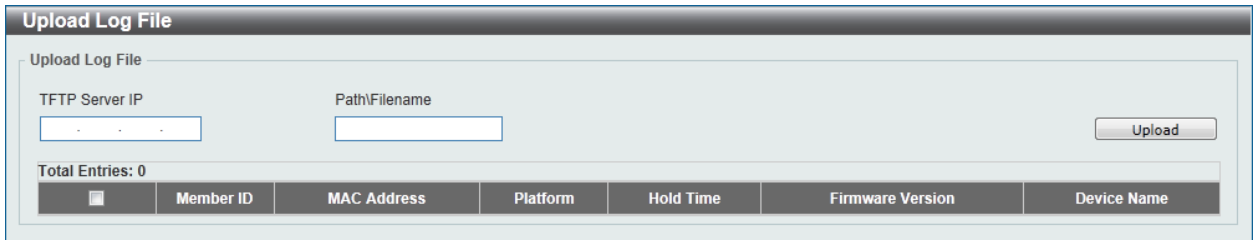

Figure 4-64 Upload Log File window

The fields that can be configured are described below:

Parameter	Description
TFTP Server IP	Enter the TFTP server IP address.
Path/Filename	Enter the path and file name.

Click the **Upload** button to initiate the file transfer.

D-Link Discovery Protocol

This window is used to configure and display D-Link Discovery Protocol (DDP).

To view the following window, click **Management > D-Link Discovery Protocol**, as shown below:

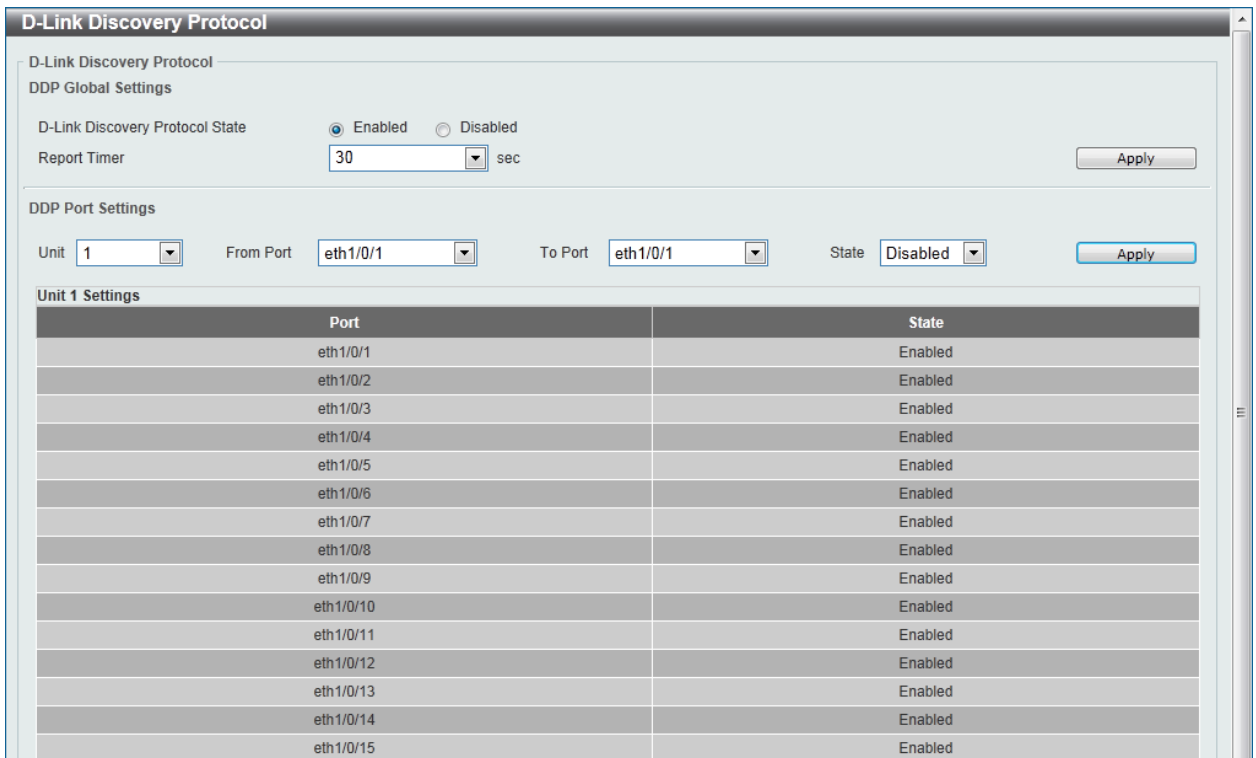

Figure 4-65 D-Link Discovery Protocol window

The fields that can be configured for **D-Link Discovery Protocol** are described below:

Parameter	Description
D-Link Discovery Protocol State	Select this option to enable or disable DDP global state.
Report Timer	Select the interval in seconds between two consecutive DDP report messages. Options to choose from are 30, 60, 90,120 , and Never .

Click the **Apply** button to accept the changes made.

The fields that can be configured for **DDP Port Settings** are described below:

Parameter	Description
Unit	Select the switch unit that will be used for this configuration here.
From Port / To Port	Select the appropriate port range used for the configuration here.
State	Select this option to enable or disable DDP port state.

Click the **Apply** button to accept the changes made.

5. Layer 2 Features

FDB
VLAN
Spanning Tree
Loopback Detection
Link Aggregation
L2 Multicast Control
LLDP

FDB

Static FDB

Unicast Static FDB

This window is used to view and configure the static unicast forwarding settings on the Switch.

To view the following window, click **L2 Features > FDB > Static FDB > Unicast Static FDB**, as shown below:

Figure 5-1 Unicast Static FDB window

The fields that can be configured are described below:

Parameter	Description
Port / Drop	Allows the selection of the port number on which the MAC address entered resides. This option could also drop the MAC address from the unicast static FDB. When selecting Port , select the switch unit and port number.
Unit Number	Select the switch unit that will be used for this configuration here, when Port is selected in the previous drop-down list.
Port Number	Select the port number used here, when Port is selected in the previous drop-down list.
VID	Enter the VLAN ID on which the associated unicast MAC address resides.
MAC Address	Enter the MAC address to which packets will be statically forwarded or dropped. This must be a unicast MAC address.

Click the **Apply** button to accept the changes made.

Click the **Delete All** button to delete all the entries found in the display table.

Click the **Delete** button to remove the specified entry.

Multicast Static FDB

This window is used to view and configure the multicast static FDB settings. To view the following window, click **L2 Features > FDB > Static FDB > Multicast Static FDB**, as shown below:

Figure 5-2 Multicast Static FDB window

The fields that can be configured are described below:

Parameter	Description
Unit	Select the switch unit that will be used for this configuration here.
From Port / To Port	Select the appropriate port range used for the configuration here.
VID	Enter the VLAN ID of the VLAN the corresponding MAC address belongs to.
MAC Address	Enter the static destination MAC address of the multicast packets. This must be a multicast MAC address. The format of the destination MAC address is 01-XX-XX-XX-XX-XX.

Click the **Apply** button to accept the changes made.

Click the **Delete All** button to remove all the entries.

Click the **Delete** button to remove the specific entry.

MAC Address Table Settings

This window is used to view and configure the MAC address table's global settings.

To view the following window, click **L2 Features > FDB > MAC Address Table Settings**, as shown below:

Figure 5-3 MAC Address Table Settings (Global Settings) window

The fields that can be configured are described below:

Parameter	Description
Aging Time	Enter the MAC address table's aging time value here. This value must be between 10 and 1000000 seconds. Entering 0 will disable MAC address aging. By default, this value is 300 seconds.

Aging Destination Hit

Select to enable or disable the aging destination hit function.

Click the **Apply** button to accept the changes made.After clicking the **MAC Address Learning** tab, at the top of the page, the following page will be available.

Port	State
eth1/0/1	Enabled
eth1/0/2	Enabled
eth1/0/3	Enabled
eth1/0/4	Enabled
eth1/0/5	Enabled
eth1/0/6	Enabled
eth1/0/7	Enabled
eth1/0/8	Enabled
eth1/0/9	Enabled
eth1/0/10	Enabled
eth1/0/11	Enabled
eth1/0/12	Enabled
eth1/0/13	Enabled
eth1/0/14	Enabled
eth1/0/15	Enabled

Figure 5-4 MAC Address Table Settings (MAC Address Learning) window

The fields that can be configured are described below:

Parameter	Description
Unit	Select the switch unit that will be used for this configuration here.
From Port / To Port	Select the range of ports that will be used for this configuration here.
State	Select to enable or disable the MAC address learning function on the ports specified here.

Click the **Apply** button to accept the changes made.

MAC Address Table

This window is used to view the entries listed in the MAC address table.

To view the following window, click **L2 Features > FDB > MAC Address Table**, as shown below:

VID	MAC Address	Type	Port
1	00-01-02-03-04-00	Static	CPU
1	00-03-FF-BE-2E-18	Dynamic	eth1/0/1
1	00-84-57-00-00-00	Static	eth1/0/3
1	01-00-00-00-00-02	Static	eth1/0/2

Figure 5-5 MAC Address Table window

The fields that can be configured are described below:

Parameter	Description
Port	Select the switch unit and the port that will be used for this configuration here.
VLAN ID	Enter the VLAN ID that will be used for this configuration here.
MAC Address	Enter the MAC address that will be used for this configuration here.

Click the **Apply** button to accept the changes made.

Click the **Clear Dynamic by Port** button to clear the dynamic MAC address listed on the corresponding port.

Click the **Clear Dynamic by VLAN** button to clear the dynamic MAC address listed on the corresponding VLAN.

Click the **Clear Dynamic by MAC** button to clear the dynamic MAC address entered.

Click the **Find** button to locate a specific entry based on the information entered.

Click the **Clear All** button to clear all dynamic MAC addresses.

Click the **View All** button to display all the MAC addresses recorded in the MAC address table.

MAC Notification

This window is used to view and configure MAC notification.

To view the following window, click **L2 Features > FDB > MAC Notification**, as shown below:

MAC Notification

MAC Notification Settings | MAC Notification History

MAC Notification Global Settings

MAC Address Notification Enabled Disabled

Interval (1-2147483647) sec

History Size (0-500)

MAC Notification Trap State Enabled Disabled

Unit From Port To Port Added Trap Removed Trap

Unit 1 Settings

Port	Added Trap	Removed Trap
eth1/0/1	Disabled	Disabled
eth1/0/2	Disabled	Disabled
eth1/0/3	Disabled	Disabled
eth1/0/4	Disabled	Disabled
eth1/0/5	Disabled	Disabled
eth1/0/6	Disabled	Disabled
eth1/0/7	Disabled	Disabled
eth1/0/8	Disabled	Disabled
eth1/0/9	Disabled	Disabled
eth1/0/10	Disabled	Disabled
eth1/0/11	Disabled	Disabled
eth1/0/12	Disabled	Disabled
eth1/0/13	Disabled	Disabled
eth1/0/14	Disabled	Disabled
eth1/0/15	Disabled	Disabled

Figure 5-6 MAC Notification (MAC Notification Settings) window

The fields that can be configured are described below:

Parameter	Description
MAC Address Notification	Select to enable or disable MAC notification globally on the Switch.
Interval	Enter the time value between notifications. This value must be between 1 and 2147483647 seconds. By default, this value is 1 second.
History Size	Enter the maximum number of entries listed in the history log used for notification. This value must be between 0 and 500. By default, this value is 1.
MAC Notification Trap State	Select this option to enable or disable the MAC notification trap state.
Unit	Select the switch unit that will be used for this configuration here.
From Port / To Port	Select the range of ports that will be used for this configuration here.
Added Trap	Select this option to enable or disable the added trap for the port(s) selected.
Removed Trap	Select this option to enable or disable the removed trap for the port(s) selected.

Click the **Apply** button to accept the changes made for each individual section.

After clicking the **MAC Notification History** tab, the following page will be available.

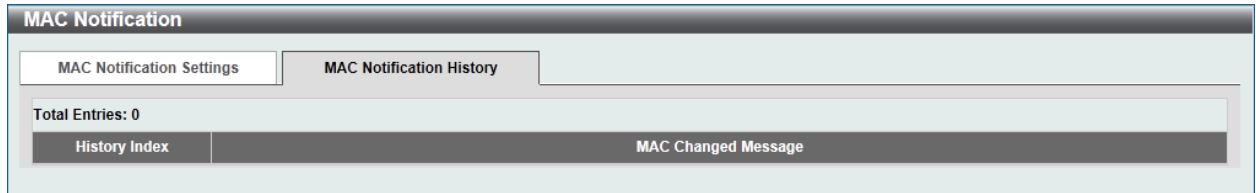

Figure 5-7 MAC Notification (MAC Notification History) window

A list of MAC notification messages will be displayed.

VLAN

802.1Q VLAN

This window is used to view and configure the VLAN settings on this switch.

To view the following window, click **L2 Features > VLAN > 802.1Q VLAN**, as shown below:

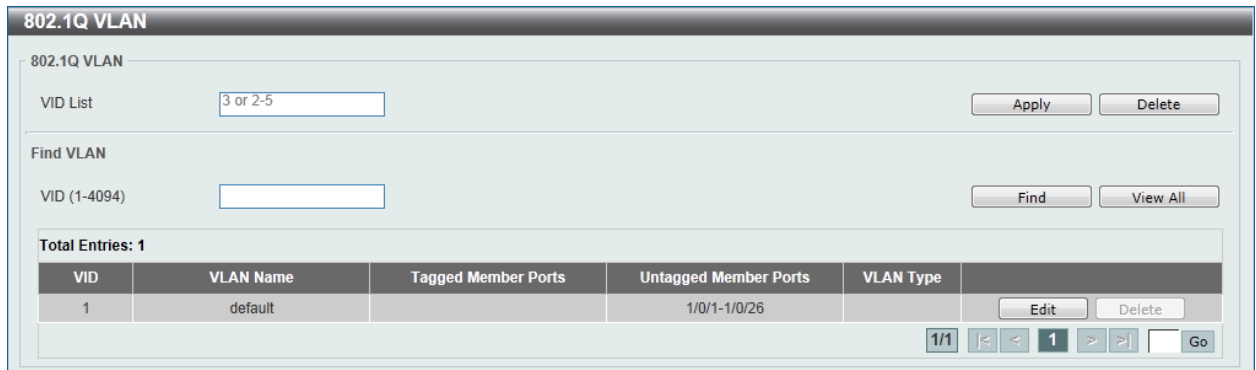

Figure 5-8 802.1Q VLAN window

The fields that can be configured for **802.1Q VLAN** are described below:

Parameter	Description
VID List	Enter the VLAN ID list that will be created here.

Click the **Apply** button to accept the changes made.

Click the **Delete** button to remove the specific entry.

The fields that can be configured for **Find VLAN** are described below:

Parameter	Description
VID	Enter the VLAN ID that will be displayed here.

Click the **Find** button to locate a specific entry based on the information entered.

Click the **View All** button to locate all the entries.

Click the **Edit** button to re-configure the specific entry.

Enter a page number and click the **Go** button to navigate to a specific page when multiple pages exist.

GVRP

GVRP Global

This window is used to view and configure the GARP VLAN Registration Protocol (GVRP) global settings. To view the following window, click **L2 Features > VLAN > GVRP > GVRP Global**, as shown below:

Figure 5-9 GVRP Global window

The fields that can be configured are described below:

Parameter	Description
Global GVRP State	Select this option to enable or disable the global GVRP state here.
Dynamic VLAN Creation	Select this option to enable or disable the dynamic VLAN creation function here.

Click the **Apply** button to accept the changes made.

GVRP Port

This window is used to view and configure the GVRP port settings.

To view the following window, click **L2 Features > VLAN > GVRP > GVRP Port**, as shown below:

Port	GVRP Status	Join Time	Leave Time	Leave All Time
eth1/0/1	Disabled	20	60	1000
eth1/0/2	Disabled	20	60	1000
eth1/0/3	Disabled	20	60	1000
eth1/0/4	Disabled	20	60	1000
eth1/0/5	Disabled	20	60	1000
eth1/0/6	Disabled	20	60	1000
eth1/0/7	Disabled	20	60	1000
eth1/0/8	Disabled	20	60	1000
eth1/0/9	Disabled	20	60	1000
eth1/0/10	Disabled	20	60	1000
eth1/0/11	Disabled	20	60	1000
eth1/0/12	Disabled	20	60	1000
eth1/0/13	Disabled	20	60	1000
eth1/0/14	Disabled	20	60	1000
eth1/0/15	Disabled	20	60	1000

Figure 5-10 GVRP Port window

The fields that can be configured are described below:

Parameter	Description
Unit	Select the switch unit that will be used for this configuration here.
From Port / To Port	Select the appropriate port range used for the configuration here.
GVRP Status	Select this option to enable or disable the GVRP port status. This enables the port to dynamically become a member of a VLAN. By default, this option is disabled.
Join Time	Enter the Join Time value in centiseconds. This value must be between 10 and 10000 centiseconds. By default, this value is 20 centiseconds.
Leave Time	Enter the Leave Time value in centiseconds. This value must be between 10 and 10000 centiseconds. By default, this value is 60 centiseconds.
Leave All Time	Enter the Leave All Time value in centiseconds. This value must be between 10 and 10000 centiseconds. By default, this value is 1000 centiseconds.

Click the **Apply** button to accept the changes made.

GVRP Advertise VLAN

This window is used to view and configure the GVRP advertised VLAN settings.

To view the following window, click **L2 Features > VLAN > GVRP > GVRP Advertise VLAN**, as shown below:

The screenshot shows the 'GVRP Advertise VLAN' configuration window. At the top, there are several configuration fields: 'Unit' (set to 1), 'From Port' (set to eth1/0/1), 'To Port' (set to eth1/0/1), 'Action' (set to Add), and 'Advertise VID List' (set to 1,3 or 2-5). An 'Apply' button is located to the right of these fields. Below the configuration fields is a section titled 'Unit 1 Settings' which contains a table with two columns: 'Port' and 'Advertise VLAN'. The table lists 15 ports from eth1/0/1 to eth1/0/15, with the 'Advertise VLAN' column currently empty for all ports.

Figure 5-11 GVRP Advertise VLAN window

The fields that can be configured are described below:

Parameter	Description
Unit	Select the switch unit that will be used for this configuration here.
From Port / To Port	Select the appropriate port range used for the configuration here.
Action	Select the advertised VLAN to port mapping action that will be taken here. Options to choose from are All , Add , Remove and Replace . When selecting All , all the advertised VLANs will be used.
Advertise VID List	Enter the advertised VLAN ID list here.

Click the **Apply** button to accept the changes made.

GVRP Forbidden VLAN

This window is used to view and configure the GVRP forbidden VLAN settings.

To view the following window, click **L2 Features > VLAN > GVRP > GVRP Forbidden VLAN**, as shown below:

Figure 5-12 GVRP Forbidden VLAN window

The fields that can be configured are described below:

Parameter	Description
Unit	Select the switch unit that will be used for this configuration here.
From Port / To Port	Select the appropriate port range used for the configuration here.
Action	Select the forbidden VLAN to port mapping action that will be taken here. Options to choose from are All , Add , Remove and Replace . When selecting All , all the forbidden VLANs will be used.
Forbidden VID List	Enter the forbidden VLAN ID list here.

Click the **Apply** button to accept the changes made.

GVRP Statistics Table

This window is used to display GVRP statistics information.

To view the following window, click **L2 Features > VLAN > GVRP > GVRP Statistics Table**, as shown below:

Port		JoinEmpty	JoinIn	LeaveEmpty	LeaveIn	LeaveAll	Empty
eth1/0/1	RX	0	0	0	0	0	0
	TX	0	0	0	0	0	0
eth1/0/2	RX	0	0	0	0	0	0
	TX	0	0	0	0	0	0
eth1/0/3	RX	0	0	0	0	0	0
	TX	0	0	0	0	0	0
eth1/0/4	RX	0	0	0	0	0	0
	TX	0	0	0	0	0	0
eth1/0/5	RX	0	0	0	0	0	0
	TX	0	0	0	0	0	0
eth1/0/6	RX	0	0	0	0	0	0
	TX	0	0	0	0	0	0
eth1/0/7	RX	0	0	0	0	0	0
	TX	0	0	0	0	0	0
eth1/0/8	RX	0	0	0	0	0	0
	TX	0	0	0	0	0	0

Figure 5-13 GVRP Statistics Table window

The fields that can be configured are described below:

Parameter	Description
Unit	Select the switch unit that will be used for this configuration here.
Port	Select the port number of which GVRP statistic information will be displayed.

Click the **Find** button to locate a specific entry based on the information entered.

Click the **Clear** button to clear all the information for the specific port.

Click the **View All** button to view all GVRP statistic information.

Click the **Clear All** button to clear all the information in this table.

Asymmetric VLAN

This window is used to configure the asymmetric VLAN function.

To view the following window, click **L2 Features > VLAN > Asymmetric VLAN**, as shown below:

Figure 5-14 Asymmetric VLAN window

The fields that can be configured are described below:

Parameter	Description
Asymmetric VLAN State	Select this option to enable or disable the asymmetric VLAN function

Click the **Apply** button to accept the changes made.

VLAN Interface

This window is used to view and configure VLAN interface settings.

To view the following window, click **L2 Features > VLAN > VLAN Interface**, as shown below:

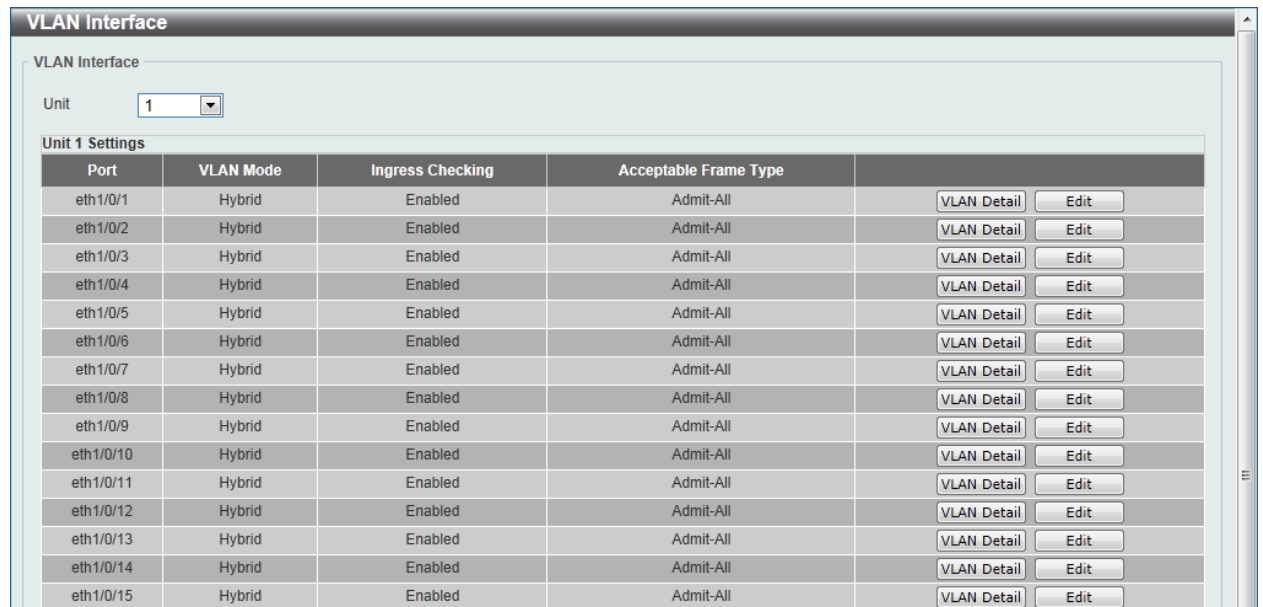

Figure 5-15 VLAN Interface window

The fields that can be configured are described below:

Parameter	Description
Unit	Select the switch unit that will be used for this configuration here.

Click the **View Detail** button to view more detailed information about the VLAN on the specific interface.

Click the **Edit** button to re-configure the specific entry.

After clicking the **VLAN Detail** button, the following page will appear.

VLAN Interface Information	
Port	eth1/0/1
VLAN Mode	Hybrid
Native VLAN	1
Hybrid Untagged VLAN	1
Hybrid Tagged VLAN	
Dynamic Tagged VLAN	
Ingress Checking	Enabled
Acceptable Frame Type	Admit-All

Figure 5-16 VLAN Interface Information window

More detailed information about the VLAN of the specific interface is displayed.

Click the **Back** button to return to the previous window.

After click the **Edit** button, the following window will appear. This is a dynamic window that will change when a different **VLAN Mode** was selected. When **Access** was selected as the **VLAN Mode**, the following page will appear.

Figure 5-17 Configure VLAN Interface - Access window

The fields that can be configured are described below:

Parameter	Description
VLAN Mode	Select the VLAN mode option here. Options to choose from are Access , Hybrid , and Trunk .
Acceptable Frame	Select the acceptable frame behavior option here. Options to choose from are Tagged Only , Untagged Only , and Admit All .
Ingress Checking	Select this option to enable or disable the ingress checking function.
VID	Enter the VLAN ID used for this configuration here. This value must be between 1 and 4094.

Click the **Apply** button to accept the changes made.

Click the **Back** button to return to the previous window.

When **Hybrid** was selected as the **VLAN Mode**, the following page will appear.

Configure VLAN Interface

Configure VLAN Interface

Port: eth 1/0/1

VLAN Mode: Hybrid

Acceptable Frame: Admit All

Ingress Checking: Enabled Disabled

Native VLAN: Native VLAN

VID (1-4094):

Action: Add

Add Mode: Untagged Tagged

Allowed VLAN Range:

Back Apply

Figure 5-18 Configure VLAN Interface - Hybrid window

The fields that can be configured are described below:

Parameter	Description
VLAN Mode	Select the VLAN mode option here. Options to choose from are Access , Hybrid , and Trunk .
Acceptable Frame	Select the acceptable frame behavior option here. Options to choose from are Tagged Only , Untagged Only , and Admit All .
Ingress Checking	Select the check box to enable or disable the ingress checking function.
Native VLAN	Tick this option to enable the native VLAN function.
VID	After ticking the Native VLAN check box, this option will be available. Enter the VLAN ID used for this configuration here. This value must be between 1 and 4094.
Action	Select the action that will be taken here. Options to choose from are Add , Remove , Tagged , and Untagged .
Add Mode	Select whether to add an Untagged or Tagged parameters.
Allowed VLAN Range	Enter the allowed VLAN range information here.

Click the **Apply** button to accept the changes made.

Click the **Back** button to return to the previous window.

When **Trunk** was selected as the **VLAN Mode**, the following page will appear.

Configure VLAN Interface

Configure VLAN Interface

Port: eth 1/0/1

VLAN Mode: Trunk

Acceptable Frame: Admit All

Ingress Checking: Enabled Disabled

Native VLAN: Native VLAN

Untagged: Tagged:

VID (1-4094):

Action: All

Allowed VLAN Range:

Back Apply

Figure 5-19 Configure VLAN Interface - Trunk window

The fields that can be configured are described below:

Parameter	Description
VLAN Mode	Select the VLAN mode option here. Options to choose from are Access , Hybrid , and Trunk .
Acceptable Frame	Select the acceptable frame behavior option here. Options to choose from are Tagged Only , Untagged Only , and Admit All .
Ingress Checking	After selecting Trunk as the VLAN Mode the following parameter will be available. Select to enable or disable the ingress checking function.
Native VLAN	Tick the check box to enable the native VLAN function. Also select if this VLAN supports Untagged or Tagged frames.
VID	After ticking the Native VLAN check box, this option will be available. Enter the VLAN ID used for this configuration here. This value must be between 1 and 4094.
Action	Select the action that will be taken here. Options to choose from are All , Add , Remove , Except , and Replace .
Allowed VLAN Range	Enter the allowed VLAN range information here.

Click the **Apply** button to accept the changes made.

Click the **Back** button to return to the previous window.

Auto Surveillance VLAN

Auto Surveillance Properties

This window is used to configure the auto surveillance VLAN global settings and display the ports surveillance VLAN information.

To view the following window, click **L2 Features > VLAN > Auto Surveillance VLAN > Auto Surveillance Properties**, as shown below:

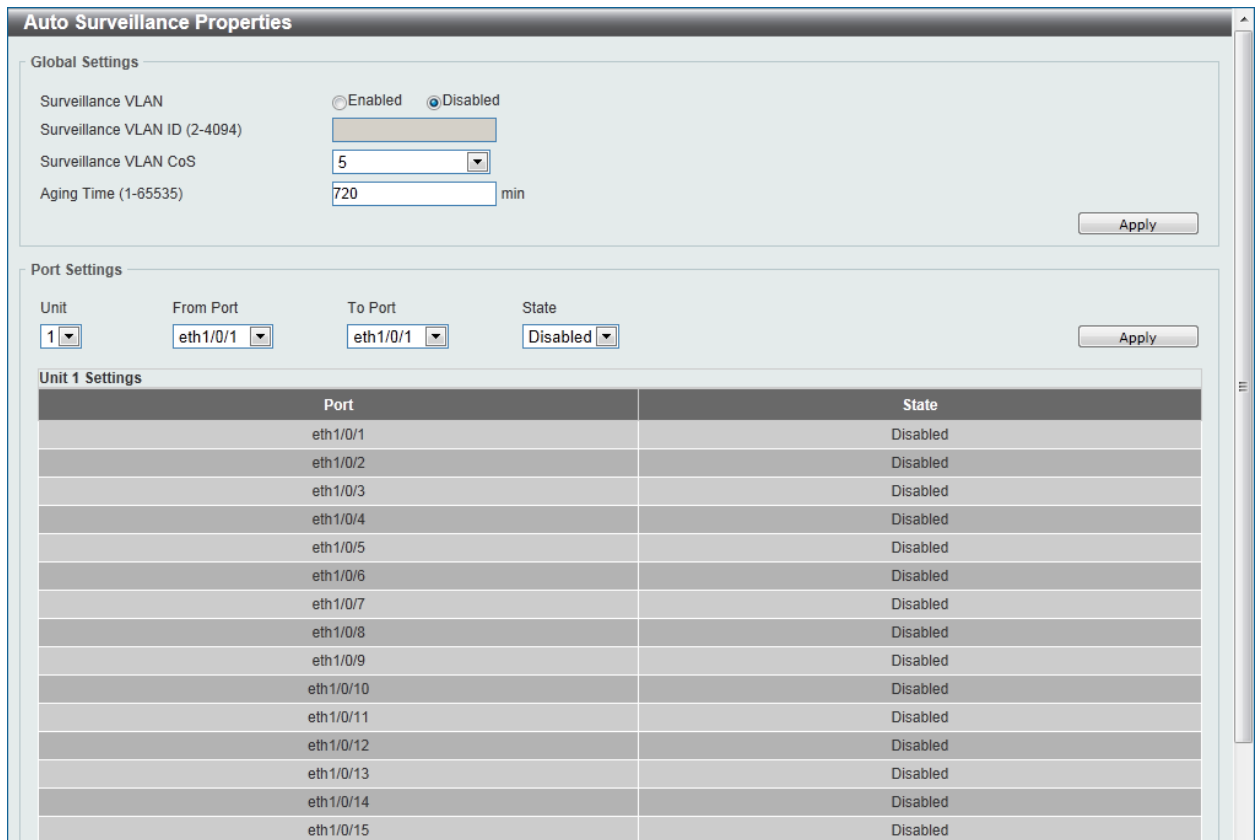

Figure 5-20 Auto Surveillance Properties window

The fields that can be configured for **Global Settings** are described below:

Parameter	Description
Surveillance VLAN	Select this option to enable or disable the surveillance VLAN state
Surveillance VLAN ID	Enter the surveillance VLAN ID. The range is from 2 to 4094.
Surveillance VLAN CoS	Select the priority of the surveillance VLAN from 0 to 7.
Aging Time	Enter the aging time of surveillance VLAN. The range is from 1 to 65535 minutes. The default value is 720 minutes. The aging time is used to remove a port from surveillance VLAN if the port is an automatic surveillance VLAN member. When the last surveillance device stops sending traffic and the MAC address of this surveillance device is aged out, the surveillance VLAN aging timer will be started. The port will be removed from the surveillance VLAN after expiration of surveillance VLAN aging timer. If the surveillance traffic resumes during the aging time, the aging timer will be reset and stop.

Click the **Apply** button to accept the changes made.

The fields that can be configured for **Port Settings** are described below:

Parameter	Description
Unit	Select the switch unit that will be used for this configuration here.
From Port / To Port	Select the appropriate port range used for the configuration here.
State	Select this option to enable or disable the state of the port.

Click the **Apply** button to accept the changes made.

MAC Settings and Surveillance Device

This window is used to configure the user-defined surveillance device OUI and display the surveillance VLAN information.

To view the following window, click **L2 Features > VLAN > Auto Surveillance VLAN > MAC Settings and Surveillance Device**, as shown below:

ID	Component Type	Description	MAC Address	Mask	
1	D-Link Device	IP Surveillance Device	28-10-7B-00-00-00	FF-FF-FF-E0-00-00	Delete
2	D-Link Device	IP Surveillance Device	28-10-7B-20-00-00	FF-FF-FF-F0-00-00	Delete
3	D-Link Device	IP Surveillance Device	B0-C5-54-00-00-00	FF-FF-FF-80-00-00	Delete
4	D-Link Device	IP Surveillance Device	F0-7D-68-00-00-00	FF-FF-FF-F0-00-00	Delete

Figure 5-21 User -defined MAC Settings window

The fields that can be configured are described below:

Parameter	Description
Component Type	Select the surveillance component type. Options to choose from are Video Management Server , VMS Client/Remote Viewer , Video Encoder , Network Storage , and Other IP Surveillance Device .
Description	Enter the description for the user-defined OUI with a maximum of 32 characters.
MAC Address	Enter the OUI MAC address.
Mask	Enter the OUI MAC address matching bitmask.

Click the **Apply** button to accept the changes made.

Click the **Delete** button to remove the specified entry.

After clicking the **Auto Surveillance VLAN Summary** tab, the following page will appear.

Port	Component Type	Description	MAC Address	Start Time
Total Entries: 0				

Figure 5-22 Auto Surveillance VLAN Summary window

The fields that can be configured are described below:

Parameter	Description
Unit	Select the switch unit that will be used for this configuration here.

Voice VLAN

Voice VLAN Global

Voice VLAN is a VLAN used to carry voice traffic from IP phone. Because the sound quality of an IP phone call will be deteriorated if the data is unevenly sent, the quality of service (QoS) for voice traffic shall be configured to ensure the transmission priority of voice packet is higher than normal traffic.

The switches determine whether a received packet is a voice packet by checking its source MAC address. If the source MAC addresses of packets comply with the organizationally unique identifier (OUI) addresses configured by the system, the packets are determined as voice packets and transmitted in voice VLAN.

To view the following window, click **L2 Features > VLAN > Voice VLAN > Voice VLAN Global**, as show below:

Figure 5-23 Voice VLAN Global window

The fields that can be configured are described below:

Parameter	Description
Voice VLAN State	Select this option to enable or disable the voice VLAN.
Voice VLAN ID	Enter the voice VLAN ID. The value is range from 2 to 4094.
Voice VLAN CoS	Select the priority of the voice VLAN from 0 to 7.
Aging Time	Enter the aging time of surveillance VLAN. The range is from 1 to 65535 minutes. The default value is 720 minutes. The aging time is used to remove a port from voice VLAN if the port is an automatic VLAN member. When the last voice device stops sending traffic and the MAC address of this voice device is aged out, the voice VLAN aging timer will be started. The port will be removed from the voice VLAN after expiration of voice VLAN aging timer. If the voice traffic resumes during the aging time, the aging timer will be reset and stop.

Click the **Apply** button to accept the changes made for each individual section.

Voice VLAN Port

This window is used to show the ports voice VLAN information.

To view the following window, click **L2 Features > VLAN > Voice VLAN > Voice VLAN Port**, as show below:

Unit: 1, From Port: eth1/0/1, To Port: eth1/0/1, State: Disabled, Mode: Auto Untagged, Apply

Port	State	Mode
eth1/0/1	Disabled	Auto/Untag
eth1/0/2	Disabled	Auto/Untag
eth1/0/3	Disabled	Auto/Untag
eth1/0/4	Disabled	Auto/Untag
eth1/0/5	Disabled	Auto/Untag
eth1/0/6	Disabled	Auto/Untag
eth1/0/7	Disabled	Auto/Untag
eth1/0/8	Disabled	Auto/Untag
eth1/0/9	Disabled	Auto/Untag
eth1/0/10	Disabled	Auto/Untag
eth1/0/11	Disabled	Auto/Untag
eth1/0/12	Disabled	Auto/Untag
eth1/0/13	Disabled	Auto/Untag
eth1/0/14	Disabled	Auto/Untag
eth1/0/15	Disabled	Auto/Untag
eth1/0/16	Disabled	Auto/Untag
eth1/0/17	Disabled	Auto/Untag

Figure 5-24 Voice VLAN Port window

The fields that can be configured are described below:

Parameter	Description
Unit	Select the switch unit that will be used for this configuration here.
From Port / To Port	Select the appropriate port range used for the configuration here.
State	Select this option to enable or disable the state of the port.
Mode	Select the mode of the port. Options to choose from are Auto Untagged , Auto Tagged , and Manual .

Click the **Apply** button to accept the changes made.

Voice VLAN OUI

This window is used to configure the user-defined voice traffic's OUI. The OUI is used to identify the voice traffic. There are a number of pre-defined OUIs. The user can further define the user-defined OUIs if needed. The user-defined OUI cannot be the same as the pre-defined OUI.

To view the following window, click **L2 Features > VLAN > Voice VLAN > Voice VLAN OUI**, as show below:

Voice VLAN OUI

Voice VLAN OUI

OUI Address: Mask: Description:

Total Entries: 8

OUI Address	Mask	Description	
00-01-E3-00-00-00	FF-FF-FF-00-00-00	Siemens	<input type="button" value="Delete"/>
00-03-6B-00-00-00	FF-FF-FF-00-00-00	Cisco	<input type="button" value="Delete"/>
00-09-6E-00-00-00	FF-FF-FF-00-00-00	Avaya	<input type="button" value="Delete"/>
00-0F-E2-00-00-00	FF-FF-FF-00-00-00	Huawei&3COM	<input type="button" value="Delete"/>
00-60-B9-00-00-00	FF-FF-FF-00-00-00	NEC&Philips	<input type="button" value="Delete"/>
00-D0-1E-00-00-00	FF-FF-FF-00-00-00	Pingtel	<input type="button" value="Delete"/>
00-E0-75-00-00-00	FF-FF-FF-00-00-00	Veritel	<input type="button" value="Delete"/>
00-E0-BB-00-00-00	FF-FF-FF-00-00-00	3COM	<input type="button" value="Delete"/>

Figure 5-25 Voice VLAN OUI window

The fields that can be configured are described below:

Parameter	Description
OUI Address	Enter the OUI MAC address.
Mask	Enter the OUI MAC address matching bitmask.
Description	Enter the description for the user-defined OUI with a maximum of 32 characters.

Click the **Apply** button to accept the changes made.

Click the **Delete** button to remove the specified entry.

Voice VLAN Device

This window is used to show voice devices that are connected to the ports. The start time is the time when the device is detected on this port, the activate time is the latest time saw the device sending the traffic.

To view the following window, click **L2 Features > VLAN > Voice VLAN > Voice VLAN Device**, as show below:

Voice VLAN Device

Voice VLAN Device Table

Unit:

Total Entries: 0

Port	Voice Device Address	Start Time	Status
------	----------------------	------------	--------

Figure 5-26 Voice VLAN Device window

The fields that can be configured are described below:

Parameter	Description
Unit	Select the switch unit that will be used for this configuration here.

Voice VLAN LLDP-MED Device

This window displays the voice VLAN LLDP-MED voice devices connected to the Switch.

To view the following window, click **L2 Features > VLAN > Voice VLAN > Voice VLAN LLDP-MED Device**, as show below:

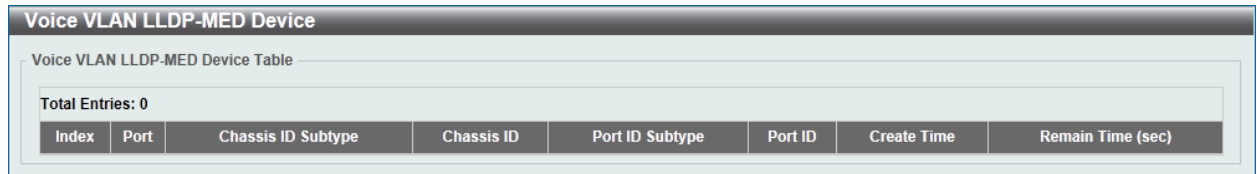

The screenshot shows a window titled "Voice VLAN LLDP-MED Device". Inside, there is a section labeled "Voice VLAN LLDP-MED Device Table" with "Total Entries: 0". Below this is a table with the following columns: Index, Port, Chassis ID Subtype, Chassis ID, Port ID Subtype, Port ID, Create Time, and Remain Time (sec).

Index	Port	Chassis ID Subtype	Chassis ID	Port ID Subtype	Port ID	Create Time	Remain Time (sec)
Total Entries: 0							

Figure 5-27 Voice VLAN LLDP-MED Device window

Spanning Tree

This Switch supports three versions of the Spanning Tree Protocol: 802.1D-1998 STP, 802.1D-2004 Rapid STP, and 802.1Q-2005 MSTP. 802.1D-1998 STP will be familiar to most networking professionals. However, since 802.1D-2004 RSTP and 802.1Q-2005 MSTP have been recently introduced to D-Link managed Ethernet switches, a brief introduction to the technology is provided below followed by a description of how to set up 802.1D-1998 STP, 802.1D-2004 RSTP, and 802.1Q-2005 MSTP.

802.1Q-2005 MSTP

Multiple Spanning Tree Protocol, or MSTP, is a standard defined by the IEEE community that allows multiple VLANs to be mapped to a single spanning tree instance, which will provide multiple pathways across the network. Therefore, these MSTP configurations will balance the traffic load, preventing wide scale disruptions when a single spanning tree instance fails. This will allow for faster convergences of new topologies for the failed instance. Frames designated for these VLANs will be processed quickly and completely throughout interconnected bridges utilizing any of the three spanning tree protocols (STP, RSTP or MSTP).

This protocol will also tag BPDU packets so receiving devices can distinguish spanning tree instances, spanning tree regions and the VLANs associated with them. An MSTI ID will classify these instances. MSTP will connect multiple spanning trees with a Common and Internal Spanning Tree (CIST). The CIST will automatically determine each MSTP region, its maximum possible extent and will appear as one virtual bridge that runs a single spanning tree. Consequentially, frames assigned to different VLANs will follow different data routes within administratively established regions on the network, continuing to allow simple and full processing of frames, regardless of administrative errors in defining VLANs and their respective spanning trees.

Each switch utilizing the MSTP on a network will have a single MSTP configuration that will have the following three attributes:

1. A configuration name defined by an alphanumeric string of up to 32 characters (defined in the **MST Configuration Identification** window in the Configuration Name field).
2. A configuration revision number (named here as a Revision Level and found in the **MST Configuration Identification** window) and;
3. A 4094-element table (defined here as a VID List in the **MST Configuration Identification** window), which will associate each of the possible 4094 VLANs supported by the Switch for a given instance.

To utilize the MSTP function on the Switch, three steps need to be taken:

1. The Switch must be set to the MSTP setting (found in the **STP Bridge Global Settings** window in the STP Version field)
2. The correct spanning tree priority for the MSTP instance must be entered (defined here as a Priority in the **MSTI Config Information** window when configuring MSTI ID settings).
3. VLANs that will be shared must be added to the MSTP Instance ID (defined here as a VID List in the **MST Configuration Identification** window when configuring an MSTI ID settings).

802.1D-2004 Rapid Spanning Tree

The Switch implements three versions of the Spanning Tree Protocol, the Multiple Spanning Tree Protocol (MSTP) as defined by the IEEE 802.1Q-2005, the Rapid Spanning Tree Protocol (RSTP) as defined by the IEEE 802.1D-2004 specification and a version compatible with the IEEE 802.1D-1998 STP. RSTP can operate with legacy equipment implementing IEEE 802.1D-1998; however the advantages of using RSTP will be lost.

The IEEE 802.1D-2004 Rapid Spanning Tree Protocol (RSTP) evolved from the 802.1D-1998 STP standard. RSTP was developed in order to overcome some limitations of STP that impede the function of some recent switching innovations, in particular, certain Layer 3 functions that are increasingly handled by Ethernet switches. The basic function and much of the terminology is the same as STP. Most of the settings configured for STP are also used for RSTP. This section introduces some new Spanning Tree concepts and illustrates the main differences between the two protocols.

Port Transition States

An essential difference between the three protocols is in the way ports transition to a forwarding state and in the way this transition relates to the role of the port (forwarding or not forwarding) in the topology. MSTP and RSTP combine the transition states disabled, blocking and listening used in 802.1D-1998 and creates a single state Discarding. In either case, ports do not forward packets. In the STP port transition states disabled, blocking or listening or in the RSTP/MSTP port state discarding, there is no functional difference, the port is not active in the network topology. Table 7-3 below compares how the three protocols differ regarding the port state transition.

All three protocols calculate a stable topology in the same way. Every segment will have a single path to the root bridge. All bridges listen for BPDU packets. However, BPDU packets are sent more frequently - with every Hello packet. BPDU packets are sent even if a BPDU packet was not received. Therefore, each link between bridges is sensitive to the status of the link. Ultimately this difference results in faster detection of failed links, and thus faster topology adjustment. A drawback of 802.1D-1998 is this absence of immediate feedback from adjacent bridges.

802.1Q-2005 MSTP	802.1D-2004 RSTP	802.1D-1998 STP	Forwarding	Learning
Disabled	Disabled	Disabled	No	No
<i>Discarding</i>	<i>Discarding</i>	<i>Blocking</i>	No	No
<i>Discarding</i>	<i>Discarding</i>	<i>Listening</i>	No	No
<i>Learning</i>	<i>Learning</i>	<i>Learning</i>	No	Yes
Forwarding	Forwarding	Forwarding	Yes	Yes

RSTP is capable of a more rapid transition to a forwarding state - it no longer relies on timer configurations - RSTP compliant bridges are sensitive to feedback from other RSTP compliant bridge links. Ports do not need to wait for the topology to stabilize before transitioning to a forwarding state. In order to allow this rapid transition, the protocol introduces two new variables: the edge port and the point-to-point (P2P) port.

Edge Port

The edge port is a configurable designation used for a port that is directly connected to a segment where a loop cannot be created. An example would be a port connected directly to a single workstation. Ports that are designated as edge ports transition to a forwarding state immediately without going through the listening and learning states. An edge port loses its status if it receives a BPDU packet, immediately becoming a normal spanning tree port.

P2P Port

A P2P port is also capable of rapid transition. P2P ports may be used to connect to other bridges. Under RSTP/MSTP, all ports operating in full-duplex mode are considered to be P2P ports, unless manually overridden through configuration.

802.1D-1998/802.1D-2004/802.1Q-2005 Compatibility

MSTP or RSTP can interoperate with legacy equipment and is capable of automatically adjusting BPDU packets to 802.1D-1998 format when necessary. However, any segment using 802.1D-1998 STP will not benefit from the rapid transition and rapid topology change detection of MSTP or RSTP. The protocol also provides for a variable used for migration in the event that legacy equipment on a segment is updated to use RSTP or MSTP.

The Spanning Tree Protocol (STP) operates on two levels:

1. On the switch level, the settings are globally implemented.
2. On the port level, the settings are implemented on a per-user-defined group of ports basis.

STP Global Settings

This window is used to view and configure the STP global settings.

To view the following window, click **L2 Features > Spanning Tree > STP Global Settings**, as shown below:

STP Global Settings

STP State
 Disabled Enabled Apply

STP Traps
 STP New Root Trap Disabled Enabled
 STP Topology Change Trap Disabled Enabled Apply

STP Mode
 STP Mode RSTP Apply

STP Priority
 Priority (0-61440) 32768 Apply

STP Configuration
 Bridge Max Age (6-40) 20 sec Bridge Hello Time (1-2) 2 sec
 Bridge Forward Time (4-30) 15 sec TX Hold Count (1-10) 6 times
 Max Hops (1-40) 20 times Apply

Figure 5-28 STP Global Settings window

The field that can be configured for **Spanning Tree State** is described below:

Parameter	Description
Spanning Tree State	Select this option to enable or disable the STP global state here.

Click the **Apply** button to accept the changes made.

The fields that can be configured for **STP Traps** are described below:

Parameter	Description
STP New Root Trap	Select this option to enable or disable the STP new root trap option here.
STP Topology Change Trap	Select this option to enable or disable the STP topology change trap option here.

Click the **Apply** button to accept the changes made.

The fields that can be configured for **STP Mode** are described below:

Parameter	Description
STP Mode	Select the STP mode used here. Options to choose from are MSTP , RSTP , and STP .

Click the **Apply** button to accept the changes made.

The fields that can be configured for **Spanning Tree Priority** are described below:

Parameter	Description
Priority	Select the STP priority value here. This value is between 0 and 61440. By default, this value is 32768. The lower the value, the higher the priority.

Click the **Apply** button to accept the changes made.

The fields that can be configured for **Spanning Tree Configuration** are described below:

Parameter	Description
Bridge Max Age	Enter the bridge's maximum age value here. This value must be between 6 and 40 seconds. By default, this value is 20 seconds. The maximum age value may be set to ensure that old information does not endlessly circulate through redundant paths in the network, preventing the effective propagation of the new information. Set by the Root Bridge, this value will aid in determining that the Switch has spanning tree configuration values consistent with other devices on the bridged LAN.
Bridge Hello Time	After selecting RSTP/STP as the STP Mode , this parameter will be available. Enter the bridge's hello time value here. This value must be between 1 and 2 seconds. By default, this value is 2 seconds. This is the interval between two transmissions of BPDU packets sent by the Root Bridge to tell all other switches that it is indeed the Root Bridge. This field will only appear here when STP or RSTP is selected for the STP Version. For MSTP, the Hello Time must be set on a port per port basis.
Bridge Forward Time	Enter the bridge's forwarding time value here. This value must be

	between 4 and 30 seconds. By default, this value is 15 seconds. Any port on the Switch spends this time in the listening state while moving from the blocking state to the forwarding state.
TX Hold Count	Enter the transmit hold count value here. This value must be between 1 and 10 times. By default, this value is 6 times. This value is used to set the maximum number of Hello packets transmitted per interval.
Max Hops	Enter the maximum number of hops that are allowed. This value must be between 1 and 40 hops. By default, this value is 20 hops. This value is used to set the number of hops between devices in a spanning tree region before the BPDU (bridge protocol data unit) packet sent by the Switch will be discarded. Each switch on the hop count will reduce the hop count by one until the value reaches zero. The Switch will then discard the BPDU packet and the information held for the port will age out.

Click the **Apply** button to accept the changes made.

STP Port Settings

This window is used to view and configure the STP port settings.

To view the following window, click **L2 Features > Spanning Tree > STP Port Settings**, as shown below:

Port	State	Cost	Guard Root	Link Type	Port Fast	TCN Filter	BPDU Forward	Priority
eth1/0/1	Enabled	0/200000	Disabled	Auto/P2P	Auto/non-edge	Disabled	Disabled	128
eth1/0/2	Enabled	0/200000	Disabled	Auto/P2P	Auto/non-edge	Disabled	Disabled	128
eth1/0/3	Enabled	0/200000	Disabled	Auto/P2P	Auto/non-edge	Disabled	Disabled	128
eth1/0/4	Enabled	0/200000	Disabled	Auto/P2P	Auto/non-edge	Disabled	Disabled	128
eth1/0/5	Enabled	0/200000	Disabled	Auto/P2P	Auto/non-edge	Disabled	Disabled	128
eth1/0/6	Enabled	0/200000	Disabled	Auto/P2P	Auto/non-edge	Disabled	Disabled	128
eth1/0/7	Enabled	0/200000	Disabled	Auto/P2P	Auto/non-edge	Disabled	Disabled	128
eth1/0/8	Enabled	0/200000	Disabled	Auto/P2P	Auto/non-edge	Disabled	Disabled	128
eth1/0/9	Enabled	0/200000	Disabled	Auto/P2P	Auto/non-edge	Disabled	Disabled	128
eth1/0/10	Enabled	0/200000	Disabled	Auto/P2P	Auto/non-edge	Disabled	Disabled	128
eth1/0/11	Enabled	0/200000	Disabled	Auto/P2P	Auto/non-edge	Disabled	Disabled	128
eth1/0/12	Enabled	0/200000	Disabled	Auto/P2P	Auto/non-edge	Disabled	Disabled	128
eth1/0/13	Enabled	0/200000	Disabled	Auto/P2P	Auto/non-edge	Disabled	Disabled	128
eth1/0/14	Enabled	0/200000	Disabled	Auto/P2P	Auto/non-edge	Disabled	Disabled	128
eth1/0/15	Enabled	0/200000	Disabled	Auto/P2P	Auto/non-edge	Disabled	Disabled	128

Figure 5-29 STP Port Settings window

The fields that can be configured are described below:

Parameter	Description
Unit	Select the switch unit that will be used for this configuration here.
From Port / To Port	Select the appropriate port range used for the configuration here.
Cost	Enter the cost value here. This value must be between 1 and 200000000. This value defines a metric that indicates the relative cost

	of forwarding packets to the specified port list. Port cost can be set automatically or as a metric value. The default value is 0 (auto). Setting 0 for the external cost will automatically set the speed for forwarding packets to the specified port(s) in the list for optimal efficiency. The default port cost for a 100Mbps port is 200000 and the default port cost for a Gigabit port is 20000. The lower the number, the greater the probability the port will be chosen to forward packets.
State	Select to enable or disable the STP port state.
Guard Root	Select to enable or disable the guard root function.
Link Type	Select the link type option here. Options to choose from are Auto , P2P , and Shared . A full-duplex port is considered to have a point-to-point (P2P) connection. On the opposite, a half-duplex port is considered to have a Shared connection. The port cannot transit into the forwarding state rapidly by setting the link type to Shared . By default this option is Auto .
Port Fast	Select the port fast option here. Options to choose from are Network , Disabled , and Edge . In the Network mode the port will remain in the non-port-fast state for three seconds. The port will change to the port-fast state if no BPDU is received and changes to the forwarding state. If the port received the BPDU later, it will change to the non-port-fast state. In the Disable mode, the port will always be in the non-port-fast state. It will always wait for the forward-time delay to change to the forwarding state. In the Edge mode, the port will directly change to the spanning-tree forwarding state when a link-up occurs without waiting for the forward-time delay. If the interface receives a BPDU later, its operation state changes to the non-port-fast state. By default, this option is Network .
TCN Filter	Select to enable or disable the TCN filter option. Enabling TC filtering on a port is useful for an ISP to prevent the external bridge to a core region of the network, causing address flushing in that region, possibly because those bridges are not under the full control of the administrator. When a port is set to the TCN filter mode, the TC event received by the port will be ignored. By default, this option is Disabled .
BPDU Forward	Select to enable or disable BPDU forwarding. If enabled, the received STP BPDU will be forwarded to all VLAN member ports in the untagged form. By default, this option is Disabled .
Priority	Select the priority value here. Options to choose from are 0 to 240 . By default this option is 128 . A lower value has higher priority.
Hello Time	Enter the hello time value here. This value must be between 1 and 2 seconds. This value specifies the interval that a designated port will wait between the periodic transmissions of each configuration message.

Click the **Apply** button to accept the changes made.

MST Configuration Identification

This window is used to view and configure the MST configuration identification settings. These settings will uniquely identify a multiple spanning tree instance set on the Switch. The Switch initially possesses one CIST, or Common Internal Spanning Tree, of which the user may modify the parameters for but cannot change the MSTI ID for, and cannot be deleted.

To view the following window, click **L2 Features > Spanning Tree > MST Configuration Identification**, as shown below:

Figure 5-30 MST Configuration Identification window

The fields that can be configured for **MST Configuration Identification** are described below:

Parameter	Description
Configuration Name	Enter the MST This name uniquely identifies the MSTI (Multiple Spanning Tree Instance). If a Configuration Name is not set, this field will show the MAC address to the device running MSTP.
Revision Level	Enter the revision level value here. This value must be between 0 and 65535. By default, this value is 0. This value, along with the Configuration Name, identifies the MSTP region configured on the Switch.

Click the **Apply** button to accept the changes made.

The fields that can be configured for **Instance ID Settings** are described below:

Parameter	Description
Instance ID	Enter the instance ID here. This value must be between 1 and 16.
Action	Select the action that will be taken here. Options to choose from are Add VID and Remove VID .
VID List	Enter the VID list value here. This field is used to specify the VID range from configured VLANs set on the Switch.

Click the **Apply** button to accept the changes made.

Click the **Edit** button to re-configure the specific entry.

Click the **Delete** button to remove the specific entry.

Enter a page number and click the **Go** button to navigate to a specific page when multiple pages exist.

STP Instance

This window is used to view and configure the STP instance settings.

To view the following window, click **L2 Features > Spanning Tree > STP Instance**, as shown below:

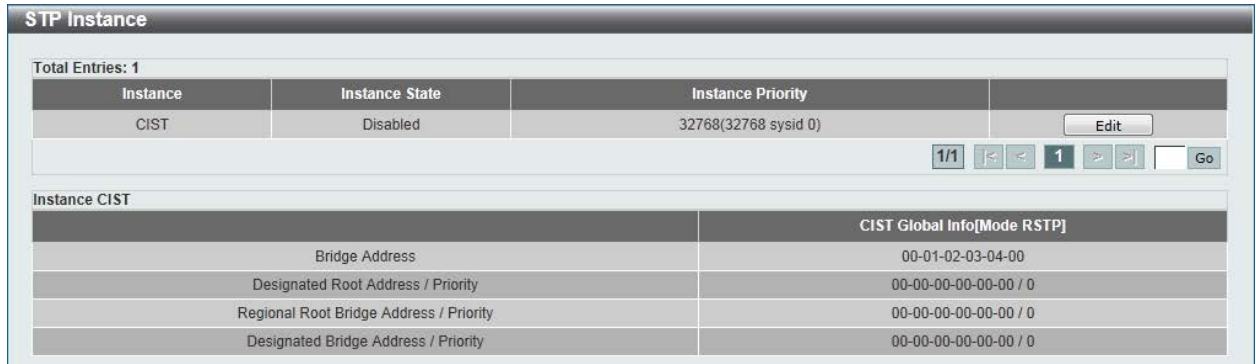

Figure 5-31 STP Instance window

Click the **Edit** button to re-configure the specific entry.

Enter a page number and click the **Go** button to navigate to a specific page when multiple pages exist.

MSTP Port Information

This window is used to view and configure the MSTP port information settings.

To view the following window, click **L2 Features > Spanning Tree > MSTP Port Information**, as shown below:

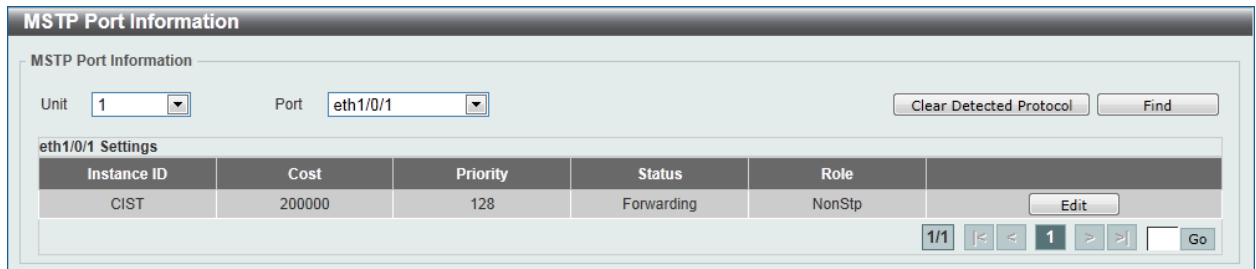

Figure 5-32 MSTP Port Information window

The fields that can be configured are described below:

Parameter	Description
Unit	Select the switch unit that will be used for this configuration here.
Port	Select the port number that will be cleared here.

Click the **Clear Detected Protocol** button to clear the detected protocol settings for the port selected.

Click the **Find** button to locate a specific entry based on the information entered.

Click the **Edit** button to re-configure the specific entry.

Enter a page number and click the **Go** button to navigate to a specific page when multiple pages exist.

Loopback Detection

The Loopback Detection (LBD) function is used to detect the loop created by a specific port. This feature is used to temporarily shut down a port on the Switch when a CTP (Configuration Testing Protocol) packet has been looped back to the Switch. When the Switch detects CTP packets received from a port

or a VLAN, this signifies a loop on the network. The Switch will automatically block the port or the VLAN and send an alert to the administrator. The Loopback Detection port will restart (change to normal state) when the Loopback Detection Recover Time times out. The Loopback Detection function can be implemented on a range of ports at a time. The user may enable or disable this function using the drop-down menu.

To view the following window, click **L2 Features > Loopback Detection**, as shown below:

Port	Loopback Detection State	Result	Time Left (sec)
eth1/0/1	Disabled	Normal	-
eth1/0/2	Disabled	Normal	-
eth1/0/3	Disabled	Normal	-
eth1/0/4	Disabled	Normal	-
eth1/0/5	Disabled	Normal	-
eth1/0/6	Disabled	Normal	-
eth1/0/7	Disabled	Normal	-
eth1/0/8	Disabled	Normal	-
eth1/0/9	Disabled	Normal	-
eth1/0/10	Disabled	Normal	-

Figure 5-33 Loopback Detection window

The fields that can be configured for **Loopback Detection Global Settings** are described below:

Parameter	Description
Loopback Detection State	Select to enable or disable loopback detection. The default is Disabled .
Mode	Select the loopback detection mode. Options to choose from are Port-based and VLAN-based .
Enable VLAN ID List	Enter the VLAN ID for loop detection. This only takes effect when the VLAN-based is selected in the Mode drop-down list.
Interval	Enter the interval in seconds that the device will transmit all the CTP (Configuration Test Protocol) packets to detect a loop-back event. The valid range is from 1 to 32767 seconds. The default setting is 10 seconds.
Traps State	Select to enable or disable the loopback detection trap state.

Click the **Apply** button to accept the changes made.

The fields that can be configured for **Loopback Detection Port Settings** are described below:

Parameter	Description
Unit	Select the switch unit that will be used for this configuration here.
From Port / To Port	Select the appropriate port range used for the configuration here.
State	Select this option to enable or disable the state of the port.

Click the **Apply** button to accept the changes made.

Link Aggregation

Understanding Port Trunk Groups

Port trunk groups are used to combine a number of ports together to make a single high-bandwidth data pipeline. The Switch supports up to 32 port trunk groups with 1 to 8 ports in each group.

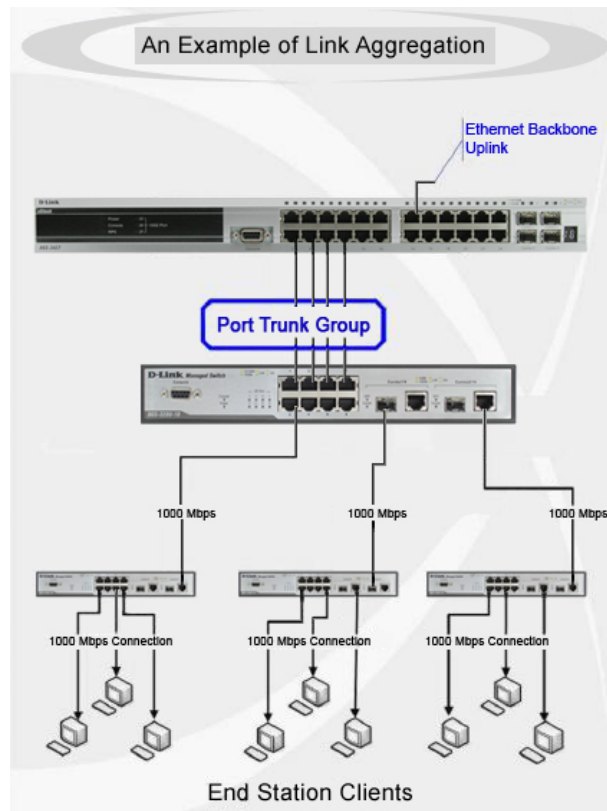

Figure 5-34 Example of Port Trunk Group

The Switch treats all ports in a trunk group as a single port. Data transmitted to a specific host (destination address) will always be transmitted over the same port in a trunk group. This allows packets in a data stream to arrive in the same order they were sent.

Link aggregation allows several ports to be grouped together and to act as a single link. This gives a bandwidth that is a multiple of a single link's bandwidth.

Link aggregation is most commonly used to link a bandwidth intensive network device or devices, such as a server, to the backbone of a network.

The Switch allows the creation of up to 32 link aggregation groups, each group consisting of 1 to 8 links (ports). Each port can only belong to a single link aggregation group.

All of the ports in the group must be members of the same VLAN, and their STP status, static multicast, traffic control; traffic segmentation and 802.1p default priority configurations must be identical. Port

locking and 802.1X must not be enabled on the trunk group. Further, the LACP aggregated links must all be of the same speed and should be configured as full duplex.

Load balancing is automatically applied to the ports in the aggregated group, and a link failure within the group causes the network traffic to be directed to the remaining links in the group.

The Spanning Tree Protocol will treat a link aggregation group as a single link, on the switch level. On the port level, the STP will use the port parameters of the Master Port in the calculation of port cost and in determining the state of the link aggregation group. If two redundant link aggregation groups are configured on the Switch, STP will block one entire group; in the same way STP will block a single port that has a redundant link.



NOTE: If any ports within the trunk group become disconnected, packets intended for the disconnected port will be load shared among the other linked ports of the link aggregation group.

This window is used to view and configure the link aggregation settings.

To view the following window, click **L2 Features > Link Aggregation**, as shown below:

Figure 5-35 Link Aggregation window

The fields that can be configured for **Link Aggregation** are described below:

Parameter	Description
System Priority	Enter the system's priority value used here. This value must be between 1 and 65535. By default, this value is 32768. The system priority determines which ports can join a port-channel and which ports are put in the stand-alone mode. The lower value has a higher priority. If two or more ports have the same priority, the port number determines the priority
Load Balance Algorithm	Select the load balancing algorithm that will be used here. Options to choose from are Source MAC , Destination MAC , Source Destination MAC , Source IP , Destination IP , and Source Destination IP . By default, this option is Source MAC .

Click the **Apply** button to accept the changes made.

The fields that can be configured for **Channel Group Information** are described below:

Parameter	Description
Unit	Select the switch unit that will be used for this configuration here.
From Port / To Port	Select the appropriate port range used for the configuration here.
Group ID	Enter the channel group number here. This value must be between 1 and 32. The system will automatically create the port-channel when a physical port first joins a channel group. An interface can only join one channel-group.
Mode	Select the mode option here. Options to choose from are On , Active , and Passive . If the mode On is specified, the channel group type is static. If the mode Active or Passive is specified, the channel group type is LACP. A channel group can only consist of either static members or LACP members. Once the type of channel group has been determined, other types of interfaces cannot join the channel group.

Click the **Add** button to add a new entry based on the information entered.

Click the **Delete Member Port** button to remove the specific member port.

Click the **Delete Channel** button to remove the specific entry.

Click the **Channel Detail** button to view more detailed information about the channel.

After clicking the **Channel Detail** button, the following page will be available.

Port Channel

Port Channel Information

Port Channel 1
Protocol Static

Port Channel Detail Information

Port	LACP Timeout	Working Mode	LACP State	Port Priority	Port Number	
eth1/0/3	None	None	down	None	None	Edit
eth1/0/4	None	None	down	None	None	Edit
eth1/0/5	None	None	down	None	None	Edit

Port Channel Neighbor Information

Port	Partner System ID	Partner PortNo	Partner LACP Timeout	Partner Working Mode	Partner Port Priority
eth1/0/3	None	None	None	None	None
eth1/0/4	None	None	None	None	None
eth1/0/5	None	None	None	None	None

Note:

LACP State:

bndl: Port is attached to an aggregator and bundled with other ports.
indep: Port is in an independent state(not bundled but able to switch data traffic).
hot-sby: Port is in a hot-standby state.
down: Port is down.

Back

Figure 5-36 Port Channel window

Click the **Edit** button to re-configure the specific entry.

Click the **Back** button to return to the previous window.

L2 Multicast Control

IGMP Snooping

Internet Group Management Protocol (IGMP) snooping allows the Switch to recognize IGMP queries and reports sent between network stations or devices and an IGMP host.

IGMP Snooping Settings

In order to use IGMP Snooping it must first be enabled for the entire Switch under IGMP Global Settings at the top of the window. You may then fine-tune the settings for each VLAN by clicking the corresponding **Edit** button. When enabled for IGMP snooping, the Switch can open or close a port to a specific multicast group member based on IGMP messages sent from the device to the IGMP host or vice versa. The Switch monitors IGMP messages and discontinues forwarding multicast packets when there are no longer hosts requesting that they continue.

To view the following window, click **L2 Features > L2 Multicast Control > IGMP Snooping > IGMP Snooping Settings**, as shown below:

Figure 5-37 IGMP Snooping Settings window

The field that can be configured for **Global Settings** is described below:

Parameter	Description
Global State	Select this option to enable or disable IGMP snooping global state.

Click the **Apply** button to accept the changes made.

The fields that can be configured for **VLAN Status Settings** are described below:

Parameter	Description
VID	Enter a VLAN ID from 1 to 4094, and select to enable or disable IGMP snooping on the VLAN.

Click the **Apply** button to accept the changes made.

The fields that can be configured for **IGMP Snooping Table** are described below:

Parameter	Description
VID	Enter a VLAN ID from 1 to 4094.

Click the **Find** button to locate a specific entry based on the information entered.

Click the **Find All** button to view all the entries.

Click the **Show Detail** button to see the detail information of the specific VLAN.

Click the **Edit** button to re-configure the specific entry.

Enter a page number and click the **Go** button to navigate to a specific page when multiple pages exist.

After clicking the **Show Detail** button, the following window will appear.

IGMP Snooping VLAN Parameters	
VID	1
Status	Enabled
Minimum Version	v1
Fast Leave	Disabled (host-based)
Report Suppression	Disabled
Suppression Time	10 seconds
Querier State	Disabled
Query Version	v3
Query Interval	125 seconds
Max Response Time	10 seconds
Robustness Value	2
Last Member Query Interval	1 seconds
Proxy Reporting	Disabled Source Address (0.0.0.0)

Figure 5-38 IGMP Snooping VLAN Parameters window

The window displays the detail information about IGMP snooping VLAN. Click the **Modify** button to edit the information in the following window.

After clicking the **Edit** button in IGMP Snooping Settings window, the following window will appear.

IGMP Snooping VLAN Settings	
VID (1-4094)	<input type="text" value="1"/>
Status	<input checked="" type="radio"/> Enabled <input type="radio"/> Disabled
Minimum Version	<input type="text" value="1"/> ▼
Fast Leave	<input type="radio"/> Enabled <input checked="" type="radio"/> Disabled
Report Suppression	<input type="radio"/> Enabled <input checked="" type="radio"/> Disabled
Suppression Time (1-300)	<input type="text" value="10"/>
Querier State	<input type="radio"/> Enabled <input checked="" type="radio"/> Disabled
Query Version	<input type="text" value="3"/> ▼
Query Interval (1-31744)	<input type="text" value="125"/> sec
Max Response Time (1-25)	<input type="text" value="10"/> sec
Robustness Value (1-7)	<input type="text" value="2"/>
Last Member Query Interval (1-25)	<input type="text" value="1"/> sec
Proxy Reporting	<input type="radio"/> Enabled <input checked="" type="radio"/> Disabled
Source Address	<input type="text" value="."/> . . .

Figure 5-39 IGMP Snooping VLAN Settings window

The fields that can be configured are described below:

Parameter	Description
Minimum Version	Select the minimum version of IGMP hosts that is allowed on the VLAN.
Fast Leave	Select this option to enable or disable the IGMP snooping fast leave function. If enabled, the membership is immediately removed when the system receive the IGMP leave message.
Report Suppression	Select this option to enable or disable the report suppression. The report suppression function only works for IGMPv1 and IGMPv2 traffic. When report suppression is enabled, the Switch suppresses the duplicate reports sent by hosts. The suppression for the same group report or leave will continue until the suppression time expired. For report or leave messages to the same group, only one report or leave message is forwarded. The remaining report and leave messages are suppressed.
Suppression Time	Enter the interval of suppressing duplicate IGMP reports or leaves. The range is from 1 to 300.
Querier State	Select this option to enable or disable the querier state.
Query Version	Select the general query packet version sent by the IGMP snooping querier. Options to choose from are 1 , 2 , and 3 .
Query Interval	Enter the interval at which the IGMP snooping querier sends IGMP general query messages periodically.
Max Response Time	Enter the maximum response time, in seconds, advertised in IGMP snooping queries. The range is 1 to 25.
Robustness Value	Enter the robustness variable used in IGMP snooping.
Last Member Query Interval	Enter the interval at which the IGMP snooping querier sends IGMP group-specific or group-source-specific (channel) query messages.
Proxy Reporting	Select this option to enable or disable the proxy-reporting function.
Source Address	Enter the source IP of proxy reporting. This is available when Enabled is selected in Proxy Reporting .

Click the **Apply** button to accept the changes made.

IGMP Snooping Groups Settings

This window is used to configure and view the IGMP snooping static group, and view IGMP snooping group.

To view the following window, click **L2 Features > L2 Multicast Control > IGMP Snooping > IGMP Snooping Groups Settings**, as shown below:

Figure 5-40 IGMP Snooping Groups Settings

The fields that can be configured for **IGMP Snooping Static Groups Settings** are described below:

Parameter	Description
VID	Enter a VLAN ID of the multicast group.
Group Address	Enter an IP multicast group address.
Unit	Select the switch unit that will be used for this configuration here.
From Port / To Port	Select the appropriate port range used for the configuration here.
VID	Click the radio button and enter a VLAN ID of the multicast group.
Group Address	Click the radio button and enter an IP multicast group address.

Click the **Apply** button to accept the changes made.

Click the **Delete** button to remove the specified entry.

Click the **Find** button to locate a specific entry based on the information entered.

Click the **Find All** button to view all the entries.

Enter a page number and click the **Go** button to navigate to a specific page when multiple pages exist.

The fields that can be configured for **IGMP Snooping Groups Table** are described below:

Parameter	Description
VID	Click the radio button and enter a VLAN ID of the multicast group.
Group Address	Click the radio button and enter an IP multicast group address.

Click the **Find** button to locate a specific entry based on the information entered.

Click the **Find All** button to view all the entries.

IGMP Snooping Mrouter Settings

This window is used to configure the specified interface(s) as the multicast router ports or as forbidden to be multicast router ports on the Switch.

To view the following window, click **L2 Features > L2 Multicast Control > IGMP Snooping > IGMP Snooping Mrouter Settings**, as shown below:

Figure 5-41 IGMP Snooping Mrouter Settings window

The fields that can be configured for **IGMP Snooping Mrouter Settings** are described below:

Parameter	Description
VID	Enter a VLAN ID between 1 and 4094.
Configuration	Select the port configuration. Options to choose from are Port , and Forbidden Port . Port - Select to have the configured ports to be static multicast router ports. Forbidden Port – Select to have the configured ports not to be multicast router ports.
Unit	Select the switch unit that will be used for this configuration here.
From Port / To Port	Select the appropriate port range used for the configuration here.

Click the **Apply** button to accept the changes made.

Click the **Delete** button to remove the specified entry.

The fields that can be configured for **IGMP Snooping Mrouter Table** are described below:

Parameter	Description
VID	Enter a VLAN ID between 1 and 4094.

Click the **Find** button to locate a specific entry based on the information entered.

Click the **Find All** button to view all the entries.

Enter a page number and click the **Go** button to navigate to a specific page when multiple pages exist.

IGMP Snooping Statistics Settings

This window is used to clear and display the IGMP snooping related statistics.

To view the following window, click **L2 Features > L2 Multicast Control > IGMP Snooping > IGMP Snooping Statistics Settings**, as shown below:

Figure 5-42 IGMP Snooping Statistics Settings window

The fields that can be configured for **IGMP Snooping Statistics Settings** are described below:

Parameter	Description
Statistics	Select the interface here. Options to choose from are All , VLAN , and Port .
VID	Enter a VLAN ID between 1 and 4094. This is available when VLAN is selected in the Statistics drop-down list.
Unit	Select the switch unit that will be used for this configuration here. This is available when Port is selected in the Statistics drop-down list.
From Port / To Port	Select the appropriate port range used for the configuration here. This is available when Port is selected in the Statistics drop-down list.

Click the **Clear** button to clear the IGMP snooping related statistics.

The fields that can be configured for **IGMP Snooping Statistics Table** are described below:

Parameter	Description
Find Type	Select the interface type. Options to choose from are VLAN , and Port .
VID	Enter a VLAN ID between 1 and 4094. This is available when VLAN is selected in the Find Type drop-down list.
Unit	Select the switch unit that will be used for this configuration here. This is available when Port is selected in the Find Type drop-down list.
From Port / To Port	Select the appropriate port range used for the configuration here. This is available when Port is selected in the Find Type drop-down list.

Click the **Find** button to locate a specific entry based on the information entered.

Click the **Find All** button to view all the entries.

Enter a page number and click the **Go** button to navigate to a specific page when multiple pages exist.

MLD Snooping

Multicast Listener Discovery (MLD) Snooping is an IPv6 function used similarly to IGMP snooping in IPv4. It is used to discover ports on a VLAN that are requesting multicast data. Instead of flooding all ports on a selected VLAN with multicast traffic, MLD snooping will only forward multicast data to ports that wish to

receive this data through the use of queries and reports produced by the requesting ports and the source of the multicast traffic.

MLD snooping is accomplished through the examination of the layer 3 part of an MLD control packet transferred between end nodes and a MLD router. When the Switch discovers that this route is requesting multicast traffic, it adds the port directly attached to it into the correct IPv6 multicast table, and begins the process of forwarding multicast traffic to that port. This entry in the multicast routing table records the port, the VLAN ID, and the associated multicast IPv6 multicast group address, and then considers this port to be an active listening port. The active listening ports are the only ones to receive multicast group data.

MLD Control Messages

Three types of messages are transferred between devices using MLD snooping. These three messages are all defined by four ICMPv6 packet headers, labeled 130, 131, 132, and 143.

1. **Multicast Listener Query** – Similar to the IGMPv2 Host Membership Query for IPv4, and labeled as 130 in the ICMPv6 packet header, this message is sent by the router to ask if any link is requesting multicast data. There are two types of MLD query messages emitted by the router. The General Query is used to advertise all multicast addresses that are ready to send multicast data to all listening ports, and the Multicast Specific query, which advertises a specific multicast address that is also ready. These two types of messages are distinguished by a multicast destination address located in the IPv6 header and a multicast address in the Multicast Listener Query Message.
2. **Multicast Listener Report, Version 1** – Comparable to the Host Membership Report in IGMPv2, and labeled as 131 in the ICMP packet header, this message is sent by the listening port to the Switch stating that it is interested in receiving multicast data from a multicast address in response to the Multicast Listener Query message.
3. **Multicast Listener Done** – Akin to the Leave Group Message in IGMPv2, and labeled as 132 in the ICMPv6 packet header, this message is sent by the multicast listening port stating that it is no longer interested in receiving multicast data from a specific multicast group address, therefore stating that it is “done” with the multicast data from this address. Once this message is received by the Switch, it will no longer forward multicast traffic from a specific multicast group address to this listening port.
4. **Multicast Listener Report, Version 2** - Comparable to the Host Membership Report in IGMPv3, and labeled as 143 in the ICMP packet header, this message is sent by the listening port to the Switch stating that it is interested in receiving multicast data from a multicast address in response to the Multicast Listener Query message.

MLD Snooping Settings

This window is used to configure the MLD snooping settings.

To view the following window, click **L2 Features > L2 Multicast Control > MLD Snooping > MLD Snooping Settings**, as shown below:

Figure 5-43 MLD Snooping Settings window

The field that can be configured for **Global Settings** is described below:

Parameter	Description
Global State	Select this option to enable or disable MLD snooping global state.

Click the **Apply** button to accept the changes made.

The fields that can be configured for **VLAN Status Settings** are described below:

Parameter	Description
VID	Enter a VLAN ID from 1 to 4094, and select to enable or disable MLD snooping on the VLAN.

Click the **Apply** button to accept the changes made.

The fields that can be configured for **MLD Snooping Table** are described below:

Parameter	Description
VID	Enter a VLAN ID from 1 to 4094.

Click the **Find** button to locate a specific entry based on the information entered.

Click the **Find All** button to view all the entries.

Click the **Show Detail** button to see the detail information of the specific VLAN.

Click the **Edit** button to re-configure the specific entry.

Enter a page number and click the **Go** button to navigate to a specific page when multiple pages exist.

After clicking the **Show Detail** button, the following window will appear.

MLD Snooping VLAN Parameters	
VID	1
Status	Enabled
Minimum Version	v1
Fast Leave	Disabled (host-based)
Report Suppression	Disabled
Suppression Time	10 seconds
Proxy Reporting	Disabled Source Address (::)
Mrouter Port Learning	Enabled
Querier State	Disabled
Query Version	v2
Query Interval	125 seconds
Max Response Time	10 seconds
Robustness Value	2
Last Listener Query Interval	1 seconds

Figure 5-44 MLD Snooping VLAN Parameters window

The window displays the detail information about MLD snooping VLAN. Click the **Modify** button to edit the information in the following window.

After clicking the **Edit** button in MLD Snooping Settings window, the following window will appear.

MLD Snooping VLAN Settings	
VID (1-4094)	<input type="text" value="1"/>
Status	<input checked="" type="radio"/> Enabled <input type="radio"/> Disabled
Minimum Version	<input type="text" value="1"/>
Fast Leave	<input type="radio"/> Enabled <input checked="" type="radio"/> Disabled
Report Suppression	<input type="radio"/> Enabled <input checked="" type="radio"/> Disabled
Suppression Time (1-300)	<input type="text" value="10"/>
Proxy Reporting	<input type="radio"/> Enabled <input checked="" type="radio"/> Disabled Source Address <input type="text"/>
Mrouter Port Learning	<input checked="" type="radio"/> Enabled <input type="radio"/> Disabled
Querier State	<input type="radio"/> Enabled <input checked="" type="radio"/> Disabled
Query Version	<input type="text" value="2"/>
Query Interval (1-31744)	<input type="text" value="125"/> sec
Max Response Time (1-25)	<input type="text" value="10"/> sec
Robustness Value (1-7)	<input type="text" value="2"/>
Last Listener Query Interval (1-25)	<input type="text" value="1"/> sec

Figure 5-45 MLD Snooping VLAN Settings window

The fields that can be configured are described below:

Parameter	Description
Minimum Version	Select the minimum version of MLD hosts that is allowed on the VLAN.
Fast Leave	Select this option to enable or disable the MLD snooping fast leave function. If enabled, the membership is immediately removed when the system receive the MLD leave message.

Report Suppression	Select this option to enable or disable the report suppression.
Suppression Time	Enter the interval of suppressing duplicate MLD reports or leaves. The range is from 1 to 300.
Proxy Reporting	Select this option to enable or disable the proxy-reporting function.
Source Address	Enter the source IP of proxy reporting. This is available when Enabled is selected in Proxy Reporting .
Mrouter Port Learning	Select this option to enable or disable Mrouter port learning.
Querier State	Select this option to enable or disable the querier state.
Query Version	Select the general query packet version sent by the MLD snooping querier. Options to choose from are 1 , and 2 .
Query Interval	Enter the interval at which the MLD snooping querier sends MLD general query messages periodically.
Max Response Time	Enter the maximum response time, in seconds, advertised in MLD snooping queries. The range is 1 to 25.
Robustness Value	Enter the robustness variable used in MLD snooping.
Last Listener Query Interval	Enter the interval at which the MLD snooping querier sends MLD group-specific or group-source-specific (channel) query messages.

Click the **Apply** button to accept the changes made.

MLD Snooping Groups Settings

This window is used to configure and view the MLD snooping static group, and view MLD snooping group.

To view the following window, click **L2 Features > L2 Multicast Control > MLD Snooping > MLD Snooping Groups Settings**, as shown below:

Figure 5-46 MLD Snooping Group Settings window

The fields that can be configured for **MLD Snooping Static Groups Settings** are described below:

Parameter	Description
VID	Enter a VLAN ID of the multicast group.

Group Address	Enter an IPv6 multicast group address.
Unit	Select the switch unit that will be used for this configuration here.
From Port / To Port	Select the appropriate port range used for the configuration here.
VID	Click the radio button and enter a VLAN ID of the multicast group.
Group Address	Click the radio button and enter an IP multicast group address.

Click the **Apply** button to accept the changes made.

Click the **Delete** button to remove the specified entry.

Click the **Find** button to locate a specific entry based on the information entered.

Click the **Find All** button to view all the entries.

Enter a page number and click the **Go** button to navigate to a specific page when multiple pages exist.

The fields that can be configured for **MLD Snooping Groups Table** are described below:

Parameter	Description
VID	Click the radio button and enter a VLAN ID of the multicast group.
Group Address	Click the radio button and enter an IP multicast group address.

Click the **Find** button to locate a specific entry based on the information entered.

Click the **Find All** button to view all the entries.

MLD Snooping Mrouter Settings

This window is used to configure the specified interface(s) as the router ports or forbidden to be IPv6 multicast router ports on the VLAN interface on the Switch.

To view the following window, click **L2 Features > L2 Multicast Control > MLD Snooping > MLD Snooping Mrouter Settings**, as shown below:

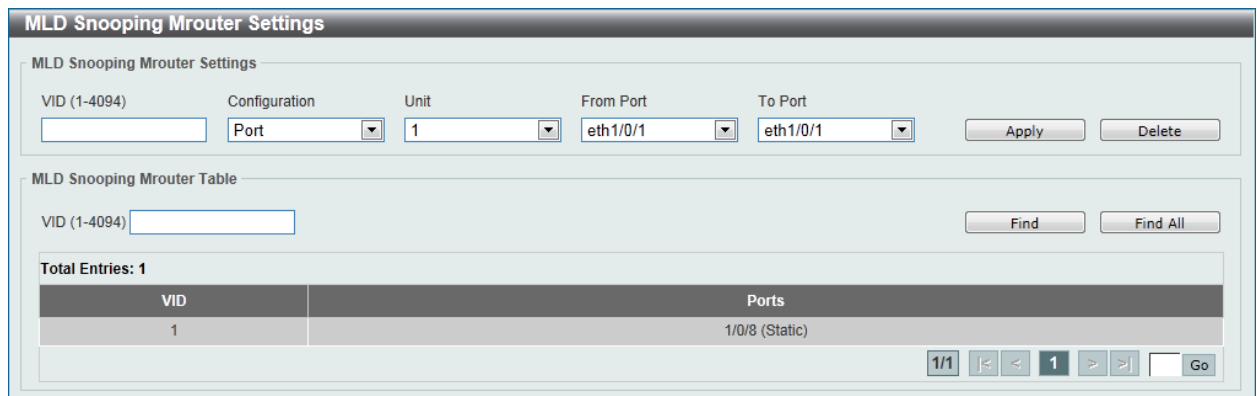

Figure 5-47 MLD Snooping Mrouter Settings window

The fields that can be configured for **MLD Snooping Mrouter Settings** are described below:

Parameter	Description
VID	Enter a VLAN ID between 1 and 4094.
Configuration	Select the port configuration. Options to choose from are Port , Forbidden Port , and Learn pimv6 .

	<p>Port - Select to have the configured ports as being connected to multicast-enabled routers.</p> <p>Forbidden Port - Select to have the configured ports as being not connected to multicast-enabled routers.</p> <p>Learn pimv6 - Select to enable dynamic learning of multicast router port.</p>
Unit	Select the switch unit that will be used for this configuration here.
From Port / To Port	Select the appropriate port range used for the configuration here.

Click the **Apply** button to accept the changes made.

Click the **Delete** button to remove the specified entry.

The fields that can be configured for **MLD Snooping Mrouter Table** are described below:

Parameter	Description
VID	Enter a VLAN ID between 1 and 4094.

Click the **Find** button to locate a specific entry based on the information entered.

Click the **Find All** button to view all the entries.

Enter a page number and click the **Go** button to navigate to a specific page when multiple pages exist.

MLD Snooping Statistics Settings

This window is used to clear and display the MLD snooping related statistics.

To view the following window, click **L2 Features > L2 Multicast Control > MLD Snooping > MLD Snooping Statistics Settings**, as shown below:

Figure 5-48 MLD Snooping Statistics Settings window

The fields that can be configured for **MLD Snooping Statistics Settings** are described below:

Parameter	Description
Statistics	Select the interface here. Options to choose from are All , VLAN , and Port .
VID	Enter a VLAN ID between 1 and 4094. This is available when VLAN is selected in the Statistics drop-down list.

Unit	Select the switch unit that will be used for this configuration here. This is available when Port is selected in the Statistics drop-down list.
From Port / To Port	Select the appropriate port range used for the configuration here. This is available when Port is selected in the Statistics drop-down list.

Click the **Clear** button to clear the MLD snooping related statistics.

The fields that can be configured for **MLD Snooping Statistics Table** are described below:

Parameter	Description
Find Type	Select the interface type. Options to choose from are VLAN , and Port .
VID	Enter a VLAN ID between 1 and 4094. This is available when VLAN is selected in the Find Type drop-down list.
Unit	Select the switch unit that will be used for this configuration here. This is available when Port is selected in the Find Type drop-down list.
From Port / To Port	Select the appropriate port range used for the configuration here. This is available when Port is selected in the Find Type drop-down list.

Click the **Find** button to locate a specific entry based on the information entered.

Click the **Find All** button to view all the entries.

Enter a page number and click the **Go** button to navigate to a specific page when multiple pages exist.

Multicast Filtering

This window is used to view and configure the Layer 2 multicast filtering settings.

To view the following window, click **L2 Features > L2 Multicast Control > Multicast Filtering**, as shown below:

Figure 5-49 Multicast Filtering window

The fields that can be configured are described below:

Parameter	Description
VID List	Enter the VLAN ID list that will be used for this configuration here.
Multicast Filter Mode	Select the multicast filter mode here. Options to choose from are Forward Unregistered , Forward All , and Filter Unregistered . When selecting the Forward Unregistered option, registered multicast packets will be forwarded based on the forwarding table and all unregistered multicast packets will be flooded based on the VLAN domain. When selecting the Forward All option, all multicast packets will be flooded based on the VLAN domain. When selecting the Filter Unregistered option, registered packets will be forwarded based on

	the forwarding table and all unregistered multicast packets will be filtered.
--	---

Click the **Apply** button to accept the changes made.

Enter a page number and click the **Go** button to navigate to a specific page when multiple pages exist.

LLDP

LLDP Global Settings

This window is used to configure the LLDP global settings.

To view the following window, click **L2 Features > LLDP > LLDP Global Settings**, as shown below:

LLDP Global Settings

LLDP Global Settings

LLDP State Enabled Disabled

LLDP Forward State Enabled Disabled

LLDP Trap State Enabled Disabled

LLDP-MED Trap State Enabled Disabled Apply

LLDP-MED Configuration

Fast Start Repeat Count (1-10) times Apply

LLDP Configurations

Message TX Interval (5-32768) sec

Message TX Hold Multiplier (2-10) sec

Rerinit Delay (1-10) sec

TX Delay (1-8192) sec Apply

LLDP System Information

Chassis ID Subtype	MAC Address
Chassis ID	00-01-02-03-04-00
System Name	Switch
System Description	Gigabit Ethernet SmartPro Switch
System Capabilities Supported	Repeater, Bridge
System Capabilities Enabled	Repeater, Bridge

LLDP-MED System Information

Device Class	Network Connectivity Device
Hardware Revision	A1
Firmware Revision	1.00.009
Software Revision	1.10.001
Serial Number	
Manufacturer Name	D-Link Corporation
Model Name	DGS-1510-28P Gigabit Ethernet Sm
Asset ID	
RoE Device Type	RSE Device

Figure 5-50 LLDP Global Settings window

The fields that can be configured for **LLDP Global Settings** are described below:

Parameter	Description
LLDP State	Select this option to enable or disable the LLDP feature
LLDP Forward State	Select this option to enable or disable LLDP forward state. When the

	LLDP State is disabled and LLDP Forward State is enabled, the received LLDPDU packet will be forwarded.
LLDP Trap State	Select this option to enable or disable the LLDP trap state.
LLDP-MED Trap State	Select this option to enable or disable the LLDP-MED trap state.

Click the **Apply** button to accept the changes made.

The fields that can be configured for **LLDP-MED Configuration** are described below:

Parameter	Description
Fast Start Repeat Count	Enter the LLDP-MED fast start repeat count value. This value must be between 1 and 10.

Click the **Apply** button to accept the changes made.

The fields that can be configured for **LLDP Configurations** are described below:

Parameter	Description
Message TX Interval	Enter the interval between consecutive transmissions of LLDP advertisements on each physical interface. The range is from 5 to 32768 seconds.
Message TX Hold Multiplier	Enter the multiplier on the LLDPDUs transmission interval that used to compute the TTL value of an LLDPDU. This value must be between 2 and 10.
Reinit Delay	Enter the delay value for LLDP initialization on an interface. This value must be between 1 and 10 seconds.
TX Delay	Enter the delay value for sending successive LLDPDUs on an interface. The valid values are from 1 to 8192 seconds and should not be greater than one-fourth of the transmission interval timer.

Click the **Apply** button to accept the changes made.

LLDP Port Settings

This window is used to configure the LLDP port settings.

To view the following window, click **L2 Features > LLDP > LLDP Port Settings**, as shown below:

Figure 5-51 LLDP Port Settings window

The fields that can be configured are described below:

Parameter	Description
Unit	Select the switch unit that will be used for this configuration here.
From Port / To Port	Select the appropriate port range used for the configuration here.
Subtype	Select the subtype of LLDP TLV(s). Options to choose from are MAC Address , and Local .
Admin State	Select the local LLDP agent and allow it to send and receive LLDP frames on the port. Options to choose from are TX , RX , TX and RX , and Disabled . TX - The local LLDP agent can only transmit LLDP frames. RX - The local LLDP agent can only receive LLDP frames. TX and RX - The local LLDP agent can both transmit and receive LLDP frames. Disabled - The local LLDP agent can neither transmit nor receive LLDP frames. The default value is TX and RX .
IP Subtype	Select the type of the IP address information to be sent. Options to choose from are All , IPv4 and IPv6 .
Action	Select this option to enable or disable the action field
Address	Enter the IP address that will be sent.

Click the **Apply** button to accept the changes made.



NOTE: The IPv4 or IPv6 address entered here should be an existing LLDP management IP address.

LLDP Management Address List

This window is used to view the LLDP management address list.

To view the following window, click **L2 Features > LLDP > LLDP Management Address List**, as shown below:

Subtype	Address	IF Type	OID	Advertising Ports
IPv4	10.90.90.90(default)	IfIndex	1.3.6.1.4.1.171.10.1...	-
IPv4	10.90.90.90	IfIndex	1.3.6.1.4.1.171.10.1...	-

Figure 5-52 LLDP Management Address List window

The fields that can be configured are described below:

Parameter	Description
All/IPv4/IPv6	Select the subtype. Options to choose from are All , IPv4 and IPv6 .

Click the **Find** button to locate a specific entry based on the information entered.

LLDP Basic TLVs Settings

Type-length-value (TLV) allows the specific sending information as a TLV element within LLDP packets. This window is used to enable the settings for the Basic TLVs Settings. An active LLDP port on the Switch always included mandatory data in its outbound advertisements. There are four optional data types that can be configured for an individual port or group of ports to exclude one or more of these data types from outbound LLDP advertisements. The mandatory data type includes four basic types of information (end of LLDPDU TLV, chassis ID TLV, port ID TLV, and Time to Live TLV). The mandatory data types cannot be disabled. There are also four data types which can be optionally selected. These include Port Description, System Name, System Description and System Capability.

To view the following window, click **L2 Features > LLDP > LLDP Basic TLVs Settings**, as shown below:

LLDP Basic TLVs Settings

Unit: 1 From Port: eth1/0/1 To Port: eth1/0/1 Port Description: Disabled System Name: Disabled System Description: Disabled System Capabilities: Disabled

Port	Port Description	System Name	System Description	System Capabilities
eth1/0/1	Disabled	Disabled	Disabled	Disabled
eth1/0/2	Disabled	Disabled	Disabled	Disabled
eth1/0/3	Disabled	Disabled	Disabled	Disabled
eth1/0/4	Disabled	Disabled	Disabled	Disabled
eth1/0/5	Disabled	Disabled	Disabled	Disabled
eth1/0/6	Disabled	Disabled	Disabled	Disabled
eth1/0/7	Disabled	Disabled	Disabled	Disabled
eth1/0/8	Disabled	Disabled	Disabled	Disabled
eth1/0/9	Disabled	Disabled	Disabled	Disabled
eth1/0/10	Disabled	Disabled	Disabled	Disabled
eth1/0/11	Disabled	Disabled	Disabled	Disabled
eth1/0/12	Disabled	Disabled	Disabled	Disabled
eth1/0/13	Disabled	Disabled	Disabled	Disabled
eth1/0/14	Disabled	Disabled	Disabled	Disabled
eth1/0/15	Disabled	Disabled	Disabled	Disabled

Figure 5-53 LLDP Basic TLVs Settings window

The fields that can be configured are described below:

Parameter	Description
Unit	Select the switch unit that will be used for this configuration here.
From Port / To Port	Select the appropriate port range used for the configuration here.
Port Description	Select this option to enable or disable the Port Description option.
System Name	Select this option to enable or disable the System Name option.
System Description	Select this option to enable or disable the System Description option.
System Capabilities	Select this option to enable or disable the System Capabilities option.

Click the **Apply** button to accept the changes made.

LLDP Dot1 TLVs Settings

LLDP Dot1 TLVs are organizationally specific TLVs which are defined in IEEE 802.1 and used to configure an individual port or group of ports to exclude one or more of the IEEE 802.1 organizational port VLAN ID TLV data types from outbound LLDP advertisements.

To view the following window, click **L2 Features > LLDP > LLDP Dot1 TLVs Settings**, as show below:

LLDP Dot1 TLVs Settings

Unit: 1 From Port: eth1/0/1 To Port: eth1/0/1 Port VLAN: Disabled Protocol VLAN: Disabled VLAN Name: Disabled Protocol Identity: Disabled None

Apply

Port	Port VLAN ID	Enabled Port and Protocol VID	Enabled VLAN Name	Enabled Protocol Identity
eth1/0/1	Disabled			
eth1/0/2	Disabled			
eth1/0/3	Disabled			
eth1/0/4	Disabled			
eth1/0/5	Disabled			
eth1/0/6	Disabled			
eth1/0/7	Disabled			
eth1/0/8	Disabled			
eth1/0/9	Disabled			
eth1/0/10	Disabled			
eth1/0/11	Disabled			
eth1/0/12	Disabled			
eth1/0/13	Disabled			
eth1/0/14	Disabled			
eth1/0/15	Disabled			

Figure 5-54 LLDP Dot1 TLVs Settings window

The fields that can be configured are described below:

Parameter	Description
Unit	Select the switch unit that will be used for this configuration here.
From Port / To Port	Select the appropriate port range used for the configuration here.
Port VLAN	Select this option to enable or disable the port VLAN ID TLV to send. The Port VLAN ID TLV is an optional fixed length TLV that allows a VLAN bridge port to advertise the port's VLAN identifier (PVID) that will be associated with untagged or priority tagged frames.
Protocol VLAN	Select this option to enable or disable Port and Protocol VLAN ID (PPVID) TLV to send, and enter the VLAN ID in PPVID TLV.
VLAN Name	Select this option to enable or disable the VLAN name TLV to send, and enter the ID of the VLAN in the VLAN name TLV.
Protocol Identity	Select this option to enable or disable the Protocol Identity TLV to send, and the protocol name. Options for protocol name to choose from are None , EAPOL , LACP , GVRP , STP , and All .

Click the **Apply** button to accept the changes made.

LLDP Dot3 TLVs Settings

This window is used to configure an individual port or group of ports to exclude one or more IEEE 802.3 organizational specific TLV data type from outbound LLDP advertisements.

To view the following window, click **L2 Features > LLDP > LLDP Dot3 TLVs Settings**, as show below:

LLDP Dot3 TLVs Settings

LLDP Dot3 TLVs Settings

Unit: 1 From Port: eth1/0/1 To Port: eth1/0/1 MAC/PHY Configuration/Status: Disabled Link Aggregation: Disabled Maximum Frame Size: Disabled Power Via MDI: Disabled

Apply

Unit 1 Settings

Port	MAC/PHY Configuration/Status	Link Aggregation	Maximum Frame Size	Power Via MDI
eth1/0/1	Disabled	Disabled	Disabled	Disabled
eth1/0/2	Disabled	Disabled	Disabled	Disabled
eth1/0/3	Disabled	Disabled	Disabled	Disabled
eth1/0/4	Disabled	Disabled	Disabled	Disabled
eth1/0/5	Disabled	Disabled	Disabled	Disabled
eth1/0/6	Disabled	Disabled	Disabled	Disabled
eth1/0/7	Disabled	Disabled	Disabled	Disabled
eth1/0/8	Disabled	Disabled	Disabled	Disabled
eth1/0/9	Disabled	Disabled	Disabled	Disabled
eth1/0/10	Disabled	Disabled	Disabled	Disabled
eth1/0/11	Disabled	Disabled	Disabled	Disabled
eth1/0/12	Disabled	Disabled	Disabled	Disabled
eth1/0/13	Disabled	Disabled	Disabled	Disabled
eth1/0/14	Disabled	Disabled	Disabled	Disabled
eth1/0/15	Disabled	Disabled	Disabled	Disabled

Figure 5-55 LLDP Dot3 TLVs Settings window

The fields that can be configured are described below:

Parameter	Description
Unit	Select the switch unit that will be used for this configuration here.
From Port / To Port	Select the appropriate port range used for the configuration here.
MAC/PHY Configuration/Status	Select this option to enable or disable the MAC/PHY Configuration/Status TLV to send. The MAC/PHY Configuration/Status TLV is an optional TLV that identifies (1) the duplex and bit-rate capability of the sending IEEE 802.3 LAN node, and (2) the current duplex and bit-rate settings of the sending IEEE 802.3 LAN node.
Link Aggregation	Select this option to enable or disable the Link Aggregation TLV to send. The Link Aggregation TLV indicates contains the following information. Whether the link is capable of being aggregated, whether the link is currently in an aggregation, and the aggregated port channel ID of the port. If the port is not aggregated, then the ID is 0.
Maximum Frame Size	Select this option to enable or disable the Maximum Frame Size TLV to send. The Maximum Frame Size TLV indicates the maximum frame size capability of the implemented MAC and PHY.
Power Via MDI	Select this option to enable or disable the power via MDI TLV to send. Three IEEE 802.3 PMD implementations (10BASE-T, 100BASE-TX and 1000BASE-T) allow power to be supplied over the link for connected non-powered systems. The Power Via MDI TLV allows network management to advertise and discover the MDI power support capabilities of the sending IEEE 802.3 LAN station.

Click the **Apply** button to accept the changes made.

LLDP-MED Port Settings

This window is used to enable or disable transmitting LLDP-MED TLVs.

To view the following window, click **L2 Features > LLDP > LLDP-MED Port Settings**, as show below:

LLDP-MED Port Settings

LLDP-MED Port Settings

Unit: 1 From Port: eth1/0/1 To Port: eth1/0/1 Capabilities: Disabled Network Policy: Disabled PSE: Disabled Inventory: Disabled

Unit 1 Settings

Port	Capabilities	Network Policy	PSE	Inventory
eth1/0/1	Disabled	Disabled	Disabled	Disabled
eth1/0/2	Disabled	Disabled	Disabled	Disabled
eth1/0/3	Disabled	Disabled	Disabled	Disabled
eth1/0/4	Disabled	Disabled	Disabled	Disabled
eth1/0/5	Disabled	Disabled	Disabled	Disabled
eth1/0/6	Disabled	Disabled	Disabled	Disabled
eth1/0/7	Disabled	Disabled	Disabled	Disabled
eth1/0/8	Disabled	Disabled	Disabled	Disabled
eth1/0/9	Disabled	Disabled	Disabled	Disabled
eth1/0/10	Disabled	Disabled	Disabled	Disabled
eth1/0/11	Disabled	Disabled	Disabled	Disabled
eth1/0/12	Disabled	Disabled	Disabled	Disabled

Figure 5-56 LLDP-MED Port Settings window

The fields that can be configured are described below:

Parameter	Description
Unit	Select the switch unit that will be used for this configuration here.
From Port / To Port	Select the appropriate port range used for the configuration here.
Capabilities	Select this option to enable or disable transmitting the LLDP-MED capabilities TLV.
Network Policy	Select this option to enable or disable transmitting the LLDP-MED network policy TLV.
PSE	Select this option to enable or disable transmitting the LLDP-MED extended power via MDI TLV, if the local device is PSE device or PD device.
Inventory	Select this option to enable or disable transmitting the LLDP-MED inventory management TLV.

Click the **Apply** button to accept the changes made.

LLDP Statistics Information

This window is used to view the neighbor detection activity, LLDP Statistics and the settings for individual ports on the Switch.

To view the following window, click **L2 Features > LLDP > LLDP Statistics Information**, as show below:

LLDP Statistics Information

LLDP Statistics Information

Last Change Time 0 Clear Counter

Total Inserts 0

Total Deletes 0

Total Drops 0

Total Ageouts 0

LLDP Statistics Ports

Unit Port Clear Counter Clear All

Unit 1 Settings

Port	Total Transmits	Total Discards	Total Errors	Total Receives	Total TLV Discards	Total TLV Unknowns	Total Ageouts
eth1/0/1	0	0	0	0	0	0	0
eth1/0/2	0	0	0	0	0	0	0
eth1/0/3	0	0	0	0	0	0	0
eth1/0/4	0	0	0	0	0	0	0
eth1/0/5	0	0	0	0	0	0	0
eth1/0/6	0	0	0	0	0	0	0
eth1/0/7	0	0	0	0	0	0	0
eth1/0/8	0	0	0	0	0	0	0
eth1/0/9	0	0	0	0	0	0	0
eth1/0/10	0	0	0	0	0	0	0
eth1/0/11	0	0	0	0	0	0	0
eth1/0/12	0	0	0	0	0	0	0
eth1/0/13	0	0	0	0	0	0	0
eth1/0/14	0	0	0	0	0	0	0
eth1/0/15	0	0	0	0	0	0	0

Figure 5-57 LLDP Statistics Information window

The fields that can be configured are described below:

Parameter	Description
Unit	Select the switch unit that will be displayed.
Port	Select the port number that will be displayed.

Click the **Clear Counter** button to clear the counter information for the statistics displayed.

Click the **Clear All** button to clear all the counter information displayed.

LLDP Local Port Information

This window is used to display the information on a per port basis currently available for populating outbound LLDP advertisements in the local port brief table shown below.

To view the following window, click **L2 Features > LLDP > LLDP Local Port Information**, as show below:

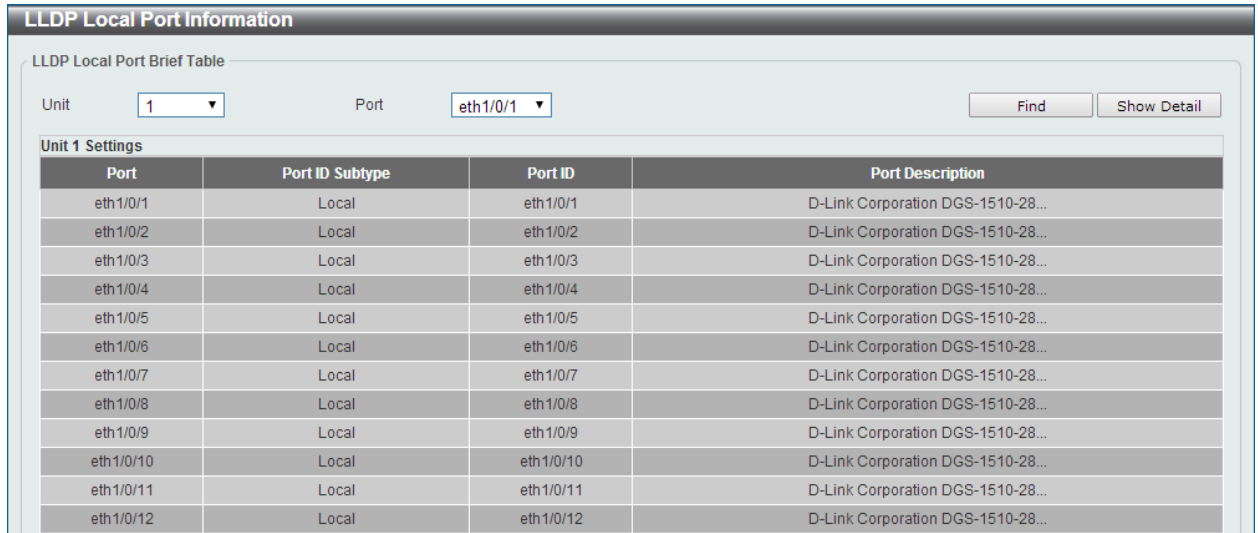

Figure 5-58 LLDP Local Port Information window

The fields that can be configured are described below:

Parameter	Description
Unit	Select the switch unit that will be displayed.
Port	Select the port number that will be displayed.

Click the **Find** button to locate a specific entry based on the information entered.

Click the **Show Detail** button to view detailed information of the specific port.

After clicking the **Show Detail** button, the following window will appear.

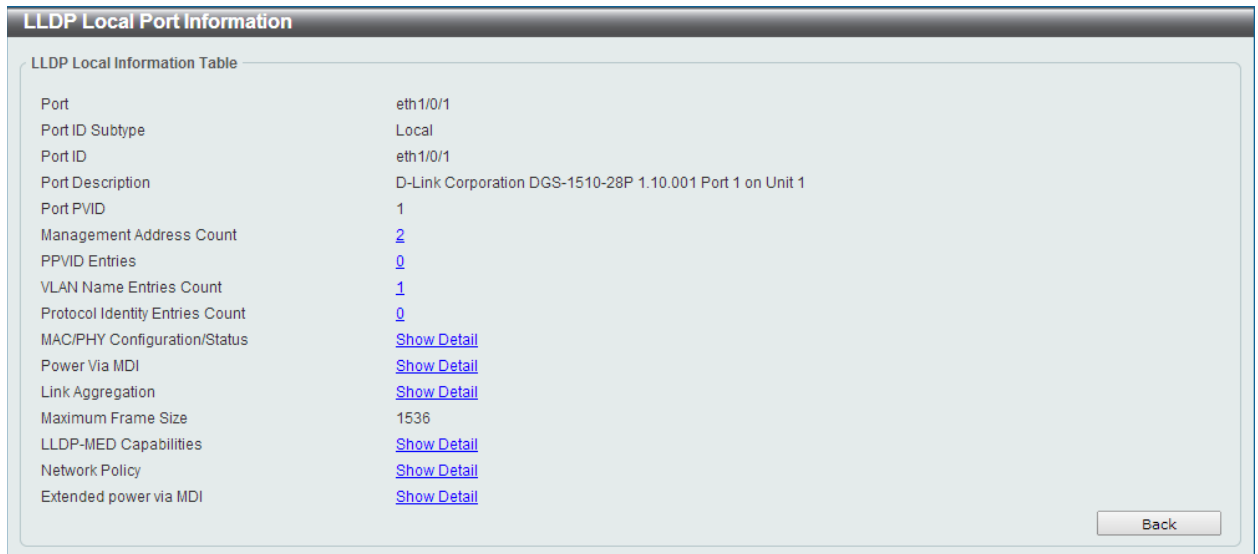

Figure 5-59 LLDP Local Port Information - Show Detail window

To view more details about, for example, the **MAC/PHY Configuration/Status**, click the [Show Detail](#) hyperlink.

Click the **Back** button to return to the previous window.

After clicking the [Show Detail](#) hyperlink, a new section will appear at the bottom of the window.



Figure 5-60 LLDP Local Port Information - Show Detail window

LLDP Neighbor Port Information

This window is used to display the information learned from the neighbors. The switch receives packets from a remote station but is able to store the information as local.

To view the following window, click **L2 Features > LLDP > LLDP Neighbor Port Information**, as show below:

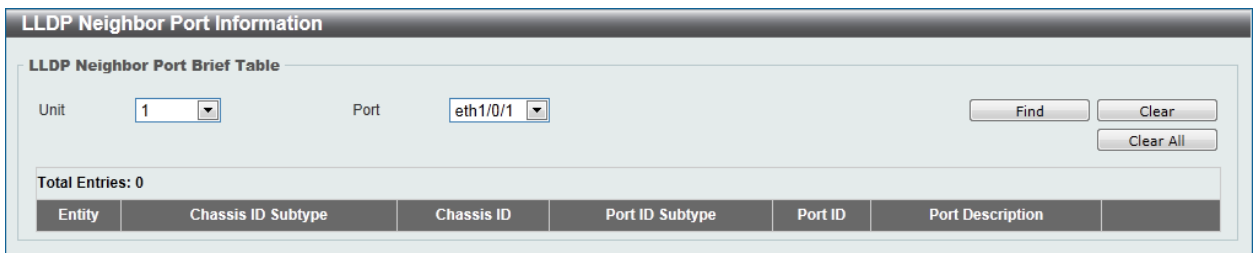

Figure 5-61 LLDP Neighbor Port Information window

The fields that can be configured are described below:

Parameter	Description
Unit	Select the switch unit that will be displayed.
Port	Select the port number that will be displayed.

Click the **Find** button to locate a specific entry based on the information entered.

Click the **Clear** button to clear the specific port information.

Click the **Clear All** button to clear all the port information displayed.

6. Layer 3 Features

ARP
Gratuitous ARP
IPv4 Interface
IPv4 Static/Default Route
IPv4 Route Table
IPv6 Interface
IPv6 Neighbor
IPv6 Static/Default Route
IPv6 Route Table

ARP

ARP Aging Time

This window is used to view and configure the ARP aging time settings.

To view the following window, click **L3 Features > ARP > ARP Aging Time**, as shown below:



Figure 6-1 ARP Aging Time window

The fields that can be configured are described below:

Parameter	Description
Timeout	Enter the ARP aging timeout value here.

Click the **Apply** button to accept the changes made.

Click the **Edit** button to re-configure the specific entry.

Enter a page number and click the **Go** button to navigate to a specific page when multiple pages exist.

Static ARP

This window is used to view and configure the static ARP settings.

To view the following window, click **L3 Features > ARP > Static ARP**, as shown below:

Figure 6-2 Static ARP window

The fields that can be configured are described below:

Parameter	Description
IP Address	Enter the IP address that will be associated with the MAC address here.
Hardware Address	Enter the MAC address that will be associated with the IP address here.

Click the **Apply** button to accept the changes made.

Click the **Edit** button to re-configure the specific entry.

Click the **Delete** button to remove the specific entry.

Enter a page number and click the **Go** button to navigate to a specific page when multiple pages exist.

Proxy ARP

This window is used to view and configure the proxy ARP settings. The Proxy ARP feature of the Switch will allow the Switch to reply to ARP requests destined for another device by faking its identity (IP and MAC Address) as the original ARP responder. Therefore, the Switch can then route packets to the intended destination without configuring static routing or a default gateway. The host, usually a Layer 3 switch, will respond to packets destined for another device.

To view the following window, click **L3 Features > ARP > Proxy ARP**, as shown below:

Figure 6-3 Proxy ARP window

The fields that can be configured are described below:

Parameter	Description
Proxy ARP State	Select to enable or disable the proxy ARP state here.
Local Proxy ARP State	Select to enable or disable the local proxy ARP state here. This local proxy ARP function allows the Switch to respond to the proxy ARP, if the source IP and destination IP are in the same interface.

Click the **Apply** button to accept the changes made.

Click the **Edit** button to re-configure the specific entry.

ARP Table

This window is used to view and configure the ARP table settings.

To view the following window, click **L3 Features > ARP > ARP Table**, as shown below:

Figure 6-4 ARP Table window

The fields that can be configured are described below:

Parameter	Description
Interface VLAN	Select and enter the interface's VLAN ID used here. This value must be between 1 and 4094 .
IP Address	Select and enter the IP address to display here.
Mask	After the IP Address option was selected, enter the mask address for the IP address here.
Hardware Address	Select and enter the MAC address to display here.
Type	Select the type option here. Options to choose from are All and Dynamic .

Click the **Find** button to locate a specific entry based on the information entered.

Click the **Clear All** button to clear all the information.

Click the **Delete** button to remove the specific entry.

Gratuitous ARP

This window is used to view and configure the gratuitous ARP settings. A gratuitous ARP request packet is an ARP request packet where the source and the destination IP address are both set to the IP address of the sending device and the destination MAC address is the broadcast address.

Generally, a device use the gratuitous ARP request packet to discover whether the IP address is duplicated by other hosts or to preload or reconfigure the ARP cache entry of hosts connected to the interface.

To view the following window, click **L3 Features > Gratuitous ARP**, as shown below:

Figure 6-5 Gratuitous ARP window

The fields that can be configured are described below:

Parameter	Description
IP Gratuitous ARP State	Select this option to enable or disable the learning of gratuitous ARP packets in the ARP cache table.
Gratuitous ARP Trap State	Select this option to enable or disable the ARP trap state.
IP Gratuitous ARP Dad-Reply State	Select this option to enable or disable the IP gratuitous ARP Dad-reply state.
Gratuitous ARP Learning State	Select this option to enable or disable the gratuitous ARP learning state. Normally, the system will only learn the ARP reply packet or a normal ARP request packet that asks for the MAC address that corresponds to the system's IP address. This option used to enable or disable the learning of ARP entries in the ARP cache based on the received gratuitous ARP packet. The gratuitous ARP packet is sent by a source IP address that is identical to the IP that the packet is queries for.

Click the **Apply** button to accept the changes made.

Click the **Edit** button to re-configure the specific entry.

Enter a page number and click the **Go** button to navigate to a specific page when multiple pages exist.

IPv4 Interface

This window is used to view and configure the IPv4 interface settings.

To view the following window, click **L3 Features > IPv4 Interface**, as shown below:

Figure 6-6 IPv4 Interface window

The fields that can be configured are described below:

Parameter	Description
Interface VLAN	Enter the interface's VLAN ID here. This value must be between 1 and 4094.

Click the **Apply** button to accept the changes made.

Click the **Find** button to locate a specific entry based on the information entered.

Click the **Edit** button to re-configure the specific entry.

Click the **Delete** button to remove the specific entry.

Enter a page number and click the **Go** button to navigate to a specific page when multiple pages exist.

After clicking the **Edit** button, the following window will be available.

Figure 6-7 IPv4 Interface Configure window

Click the **Back** button to return to the previous window.

The field that can be configured for **Settings** is described below:

Parameter	Description
State	Select this option to enable or disable the IPv4 interface's global state.

Click the **Apply** button to accept the changes made.

The fields that can be configured for **IP Settings** are described below:

Parameter	Description
Get IP From	Select the get IP from option here. Options to choose from are Static and DHCP . When the Static option is selected, users can enter the IPv4 address of this interface manually in the fields provided. When the DHCP option is selected, this interface will obtain IPv4 information automatically from the DHCP server located on the local network.
IP Address	Enter the IPv4 address for this interface here.

Mask	Enter the IPv6 subnet mask for this interface here.
Secondary	Tick the check box to use the IPv4 address and mask as the secondary interface configuration.

Click the **Apply** button to accept the changes made.

Click the **Delete** button to remove the specific entry.

Enter a page number and click the **Go** button to navigate to a specific page when multiple pages exist.

After clicking the **DHCP Client** tab, the following page will appear.

The screenshot shows the 'IPv4 Interface Configure' window with the 'DHCP Client' tab selected. The 'IPv4 Interface Settings' tab is also visible. The DHCP Client section includes the following fields:

- DHCP Client Client-ID (1-4094): A text input field.
- Class ID String: A text input field with '32 chars' and a 'Hex' checkbox.
- Host Name: A text input field with '64 chars'.
- Lease: A dropdown menu for 'Days (0-10000)' set to '00', and two dropdown menus for 'Hours' and 'Minutes', both set to '00'.

An 'Apply' button is located at the bottom right of the DHCP Client section.

Figure 6-8 DHCP Client window

The fields that can be configured are described below:

Parameter	Description
DHCP Client Client-ID	Enter the VLAN interface, whose hexadecimal MAC address will be used as the client ID to be sent with the discover message.
Class ID String	Enter the vendor class identifier with the maximum of 32 characters. Tick the Hex check box to have the class identifier in the hexadecimal form.
Host Name	Enter the host name. The maximum length is 64 characters. The host name must start with a letter, end with a letter or digit, and only with interior characters letters, digits, and hyphens.
Lease	Specify the preferred lease time for the IP address to request from the DHCP server. Enter the day duration of the lease, or select the hour and minute duration of the lease.

Click the **Apply** button to accept the changes made.

IPv4 Static/Default Route

This window is used to view and configure the IPv4 static and default route settings. The Switch supports static routing for IPv4 formatted addressing. Users can create up to 64 static route entries for IPv4. For IPv4 static routes, once a static route has been set, the Switch will send an ARP request packet to the next hop router that has been set by the user. Once an ARP response has been retrieved by the Switch from that next hop, the route becomes enabled. However, if the ARP entry already exists, an ARP request will not be sent.

The Switch also supports a floating static route, which means that the user may create an alternative static route to a different next hop. This secondary next hop device route is considered as a backup static route for when the primary static route is down. If the primary route is lost, the backup route will uplink and its status will become active.

Entries into the Switch's forwarding table can be made using both an IP address subnet mask and a gateway.

To view the following window, click **L3 Features > IPv4 Static/Default Route**, as shown below:

IPv4 Static/Default Route

IPv4 Static/Default Route

IP Address Mask Default Route

Gateway

Backup State

Total Entries: 1

IP Address	Mask	Gateway	Interface Name	
0.0.0.0	0.0.0.0	10.1.1.254	vlan1	<input type="button" value="Delete"/>

1/1

Figure 6-9 IPv4 Static/Default Route window

The fields that can be configured are described below:

Parameter	Description
IP Address	Enter the IPv4 address for this route here. Tick the Default Route check box to use the default route as the IPv4 address.
Mask	Enter the IPv4 network mask for this route here.
Gateway	Enter the gateway address for this route here.
Backup State	Select the backup state option here. Options to choose from are Primary , and Backup . When the Primary option is selected, the route will be used as the primary route to the destination. When the Backup option is selected, the route will be used as the backup route to the destination.

Click the **Apply** button to accept the changes made.

Click the **Delete** button to remove the specific entry.

Enter a page number and click the **Go** button to navigate to a specific page when multiple pages exist.

IPv4 Route Table

This window is used to view and configure the IPv4 route table settings.

To view the following window, click **L3 Features > IPv4 Route Table**, as shown below:

IPv4 Route Table

IPv4 Route Table

IP Address

Network Address

Connected Hardware Summary

Total Entries: 1

IP Address	Mask	Gateway	Interface Name	Cost	Protocol
10.0.0.0	255.0.0.0	Directly Connected	vlan1		C

1/1

Note: C - Connected, S - Static, * - Candidate Default

Figure 6-10 IPv4 Route Table window

The fields that can be configured are described below:

Parameter	Description
IP Address	Select and enter the single IPv4 address here.
Network Address	Select and enter the IPv4 network address here. In the first space enter the network prefix and in the second space enter the network mask.
Connected	Select this option to display only connected routes.
Hardware	Select this option to display only hardware routes. Hardware routes are routes that have been written into the hardware chip.
Summary	Display the brief information of the active routing entries.

Click the **Find** button to locate a specific entry based on the information entered.

Enter a page number and click the **Go** button to navigate to a specific page when multiple pages exist.

IPv6 Interface

This window is used to view and configure the IPv6 interface's settings.

To view the following window, click **L3 Features > IPv6 Interface**, as shown below:



Figure 6-11 IPv6 Interface window

The fields that can be configured are described below:

Parameter	Description
Interface VLAN	Enter the VLAN interface's ID that will be associated with the IPv6 entry.

Click the **Apply** button to accept the changes made.

Click the **Find** button to locate a specific entry based on the information entered.

Click the **Detail** button to view and configure more detailed settings for the IPv6 interface entry.

Enter a page number and click the **Go** button to navigate to a specific page when multiple pages exist.

After clicking the **Detail** button, the following page will be available.

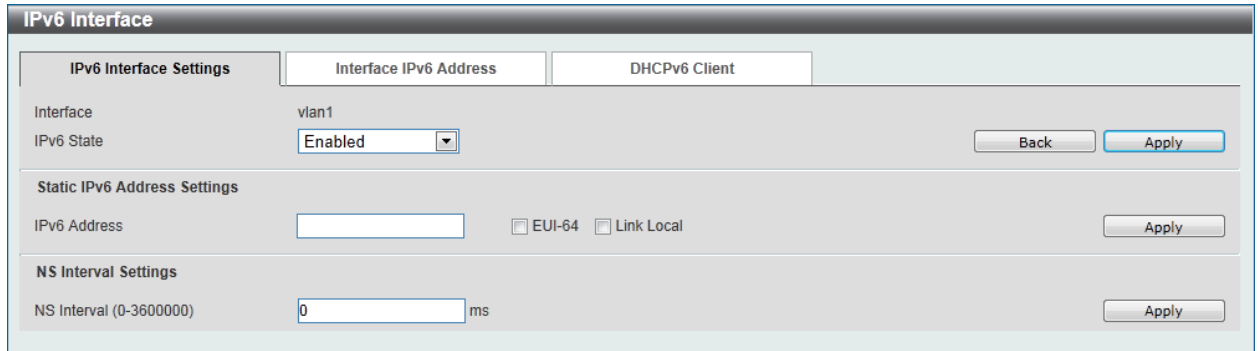

Figure 6-12 IPv6 Interface - Detail, IPv6 Interface Settings window

The fields that can be configured for **Interface** are described below:

Parameter	Description
IPv6 State	Select to enable or disable the IPv6 interface's global state here.

Click the **Back** button to return to the previous window.

Click the **Apply** button to accept the changes made.

The fields that can be configured for **Static IPv6 Address Settings** are described below:

Parameter	Description
IPv6 Address	Enter the IPv6 address for this IPv6 interface here. Select the EUI-64 option to configure an IPv6 address on the interface using the EUI-64 interface ID. Select the Link Local option to configure a link-local address for the IPv6 interface.

Click the **Apply** button to accept the changes made.

The fields that can be configured for **NS Interval Settings** are described below:

Parameter	Description
NS Interval	Enter the NS interval between 0 and 3600000 milliseconds.

Click the **Apply** button to accept the changes made.

After clicking the **Interface Address** tab, at the top of the page, the following page will be available.



Figure 6-13 IPv6 Interface - Detail, Interface IPv6 Address window

Click the **Delete** button to delete the specified entry.

After clicking the **DHCPv6 Client** tab, at the top of the page, the following page will be available.

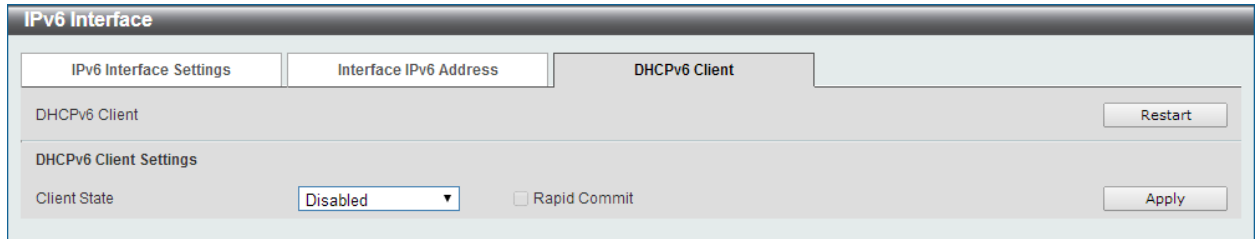

Figure 6-14 IPv6 Interface - Detail, Interface IPv6 Address window

Click the **Restart** button to restart DHCPv6 client on an interface.

The fields that can be configured for **DHCPv6 Client Settings** are described below:

Parameter	Description
Client State	Select this option to enable or disable the DHCPv6 client state. Tick the Rapid Commit check box to proceed with two-message exchange for prefix delegation.

Click the **Apply** button to accept the changes made.

IPv6 Neighbor

This window is used to configure and view the IPv6 neighbor settings.

To view the following window, click **L3 Features > IPv6 Neighbor**, as shown below:

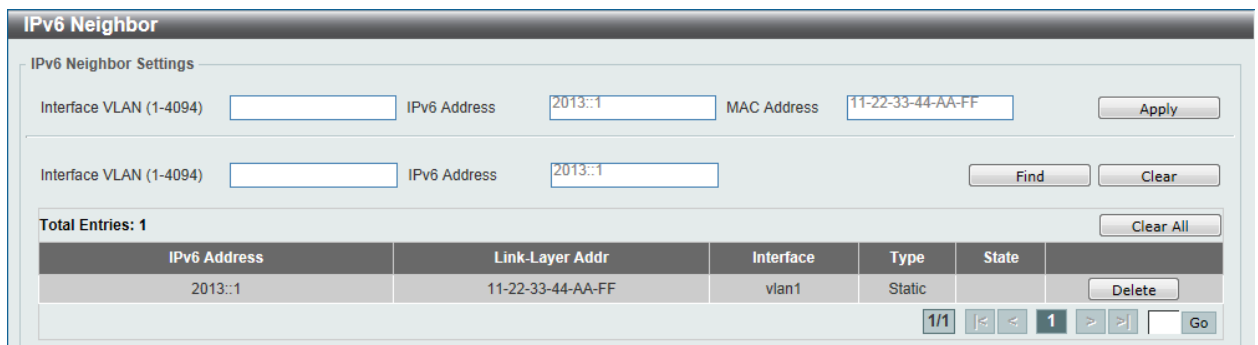

Figure 6-15 IPv6 Neighbor window

The fields that can be configured are described below:

Parameter	Description
Interface VLAN	Enter an interface VLAN ID.
IPv6 Address	Enter the IPv6 address.
MAC Address	Enter the MAC address.

Click the **Apply** button to accept the changes made.

Click the **Find** button to locate a specific entry based on the information entered.

Click the **Clear** button to clear all the information for the specific port.

Click the **Clear All** button to clear all the information in this table.

Click the **Delete** button to remove the specific entry.

Enter a page number and click the **Go** button to navigate to a specific page when multiple pages exist.

IPv6 Static/Default Route

This window is used to view and configure the IPv6 static or default routes.

To view the following window, click **L3 Features > IPv6 Static/Default Route**, as shown below:

Figure 6-16 IPv6 Static/Default Route window

The fields that can be configured are described below:

Parameter	Description
IPv6 Address/Prefix Length	Enter the IPv6 address and prefix length for this route here. Tick the Default Route option to use the default route as the IPv6 address.
Interface VLAN	Enter the interface's VLAN ID that will be associated with this route here.
Next Hop IPv6 Address	Enter the next hop IPv6 address here.
Backup State	Select the backup state option here. Options to choose from are Primary , and Backup . When the Primary option is selected, the route is specified as the primary route to the destination. When the Backup option is selected, the route is specified as the backup route to the destination.

Click the **Apply** button to accept the changes made.

IPv6 Route Table

This window is used to view and configure the IPv6 route table.

To view the following window, click **L3 Features > IPv6 Route Table**, as shown below:

Figure 6-17 IPv6 Route Table window

The fields that can be configured are described below:

Parameter	Description
IPv6 Address	Select and enter the IPv6 address to display here.
IPv6 Address/Prefix Length	Select and enter the IPv6 address and prefix length to display here. Select the Longer Prefixes option to display the route and all of the more specific routes.
Interface VLAN	Select and enter the interface's VLAN ID to display here.
Connected	Select this option to display only connected routes.
Database	Select to view all the related entries in the routing database instead of just the best route.
Hardware	Select this option to display only hardware routes. Hardware routes are routes that have been written into the hardware chip.
Summary	Display the brief information of the active routing entries.

Click the **Find** button to locate a specific entry based on the information entered.

7. Quality of Service (QoS)

Basic Settings
Advanced Settings

Basic Settings

Port Default CoS

This window is used to view and configure the port's default CoS settings.

To view the following window, click **QoS > Basic Settings > Port Default CoS**, as shown below:

Port	Default CoS	Override
eth1/0/1	0	No
eth1/0/2	0	No
eth1/0/3	0	No
eth1/0/4	0	No
eth1/0/5	0	No
eth1/0/6	0	No
eth1/0/7	0	No
eth1/0/8	0	No
eth1/0/9	0	No
eth1/0/10	0	No
eth1/0/11	0	No
eth1/0/12	0	No
eth1/0/13	0	No
eth1/0/14	0	No
eth1/0/15	0	No

Figure 7-1 Port Default CoS window

The fields that can be configured are described below:

Parameter	Description
Unit	Select the switch unit that will be used for this configuration here.
From Port / To Port	Select the appropriate port range used for the configuration here.
Default CoS	Select the default CoS option for the port(s) specified here. Options to choose from are 0 to 7 . Click the Override check box to apply the port's default CoS to all packets (tagged or untagged) received by the port. Select the None option to use the default settings.

Click the **Apply** button to accept the changes made.

Port Scheduler Method

This window is used to view and configure the port scheduler method settings.

To view the following window, click **QoS > Basic Settings > Port Scheduler Method**, as shown below:

Port	Scheduler Method
eth1/0/1	WRR
eth1/0/2	WRR
eth1/0/3	WRR
eth1/0/4	WRR
eth1/0/5	WRR
eth1/0/6	WRR
eth1/0/7	WRR
eth1/0/8	WRR
eth1/0/9	WRR
eth1/0/10	WRR
eth1/0/11	WRR
eth1/0/12	WRR
eth1/0/13	WRR
eth1/0/14	WRR
eth1/0/15	WRR

Figure 7-2 Port Scheduler Method window

The fields that can be configured are described below:

Parameter	Description
Unit	Select the switch unit that will be used for this configuration here.
From Port / To Port	Select the appropriate port range used for the configuration here.
Scheduler Method	<p>Select the scheduler method that will be applied to the specified port(s). Options to choose from are Strict Priority (SP), Round-Robin (RR), Weighted Round-Robin (WRR), and Weighted Deficit Round-Robin (WDRR). By default, the output queue scheduling algorithm is WRR.</p> <p>WDRR operates by serving an accumulated set of backlogged credits in the transmit queue in a round robin order. Initially, each queue sets its credit counter to a configurable quantum value. Every time a packet from a CoS queue is sent, the size of the packet is subtracted from the corresponding credit counter and the service right is turned over to the next lower CoS queue. When the credit counter drops below 0, the queue is no longer serviced until its credits are replenished. When the credit counters of all CoS queues reaches 0, the credit counters will be replenished at that time. All packets are serviced until their credit counter is zero or negative and the last packet is transmitted completely. When this condition happens, the credits are replenished. When the credits are replenished, a quantum of credits are added to each CoS queue credit counter. The quantum for each CoS queue may be different based on the user configuration.</p> <p>To set a CoS queue in the SP mode, any higher priority CoS queue must also be in the strict priority mode.</p> <p>WRR operates by transmitting permitted packets into the transmit queue in a round robin order. Initially, each queue sets its weight to a configurable weighting. Every time a packet from a higher priority CoS queue is sent, the corresponding weight is subtracted by 1 and the packet in the next lower CoS queue will be serviced. When the weight of a CoS queue reaches zero, the queue will not be serviced until its</p>

weight is replenished. When weights of all CoS queues reach 0, the weights get replenished at a time.

Click the **Apply** button to accept the changes made.

Queue Settings

This window is used to view and configure the queue settings.

To view the following window, click **QoS > Basic Settings > Queue Settings**, as shown below:

Port	Queue ID	WRR Weight	WDRR Quantum
eth1/0/1	0	1	1
	1	1	1
	2	1	1
	3	1	1
	4	1	1
	5	1	1
	6	1	1
	7	1	1
eth1/0/2	0	1	1
	1	1	1
	2	1	1
	3	1	1
	4	1	1
	5	1	1
	6	1	1
	7	1	1
eth1/0/3	0	1	1
	1	1	1
	2	1	1
	3	1	1
	4	1	1
	5	1	1
	6	1	1
	7	1	1

Figure 7-3 Queue Settings window

The fields that can be configured are described below:

Parameter	Description
Unit	Select the switch unit that will be used for this configuration here.
From Port / To Port	Select the appropriate port range used for the configuration here.
Queue ID	Enter the queue ID value here. This value must be between 0 and 7 .
WRR Weight	Enter the WRR weight value here. This value must be between 0 and 127. To satisfy the behavior requirements of Expedited Forwarding (EF), the highest queue is always selected by the Per-hop Behavior (PHB) EF and the schedule mode of this queue should be strict priority scheduling. So the weight of the last queue should be zero while the Differentiate Service is supported.
WDRR Quantum	Enter the WDRR quantum value here. This value must be between 0

	and 127.
--	----------

Click the **Apply** button to accept the changes made.

CoS to Queue Mapping

This window is used to view and configure the CoS-to-Queue mapping settings.

To view the following window, click **QoS > Basic Settings > CoS to Queue Mapping**, as shown below:

CoS	Queue ID
0	2
1	0
2	1
3	3
4	4
5	5
6	6
7	7

Figure 7-4 CoS to Queue Mapping window

The fields that can be configured are described below:

Parameter	Description
Queue ID	Select the queue ID that will be mapped to the corresponding CoS value. Options to choose from are 0 to 7 .

Click the **Apply** button to accept the changes made.

Port Rate Limiting

This window is used to view and configure the port rate limiting settings.

To view the following window, click **QoS > Basic Settings > Port Rate Limiting**, as shown below:

Port	Input		Output	
	Rate	Burst	Rate	Burst
eth1/0/1	No Limit	No Limit	No Limit	No Limit
eth1/0/2	No Limit	No Limit	No Limit	No Limit
eth1/0/3	No Limit	No Limit	No Limit	No Limit
eth1/0/4	No Limit	No Limit	No Limit	No Limit
eth1/0/5	No Limit	No Limit	No Limit	No Limit
eth1/0/6	No Limit	No Limit	No Limit	No Limit
eth1/0/7	No Limit	No Limit	No Limit	No Limit
eth1/0/8	No Limit	No Limit	No Limit	No Limit
eth1/0/9	No Limit	No Limit	No Limit	No Limit
eth1/0/10	No Limit	No Limit	No Limit	No Limit
eth1/0/11	No Limit	No Limit	No Limit	No Limit
eth1/0/12	No Limit	No Limit	No Limit	No Limit
eth1/0/13	No Limit	No Limit	No Limit	No Limit
eth1/0/14	No Limit	No Limit	No Limit	No Limit
eth1/0/15	No Limit	No Limit	No Limit	No Limit

Figure 7-5 Port Rate Limiting window

The fields that can be configured are described below:

Parameter	Description
Unit	Select the switch unit that will be used for this configuration here.
From Port / To Port	Select the appropriate port range used for the configuration here.
Direction	Select the direction option here. Options to choose from are Input and Output . When Input is selected, the rate limit for ingress packets is configured. When Output is selected, the rate limit for egress packets is configured.
Rate Limit	<p>Select and enter the rate limit value here.</p> <p>When Bandwidth is selected, enter the input/output bandwidth value used in the space provided. This value must be between 64 and 10000000 kbps. Also, enter the Burst Size value in the space provided. This value must be between 0 and 128000 kilobytes.</p> <p>When Percent is selected, enter the input/output bandwidth percentage value used in the space provided. This value must be between 1 and 100 percent (%). Also, enter the Burst Size value in the space provided. This value must be between 0 and 128000 kilobytes.</p> <p>Select the None option to remove the rate limit on the specified port(s). The specified limitation cannot exceed the maximum speed of the specified interface. For the ingress bandwidth limitation, the ingress can trigger a pause frame or a flow control frame when the received traffic exceeds the limitation.</p>

Click the **Apply** button to accept the changes made.

Queue Rate Limiting

This window is used to view and configure the queue rate limiting settings.

To view the following window, click **QoS > Basic Settings > Queue Rate Limiting**, as shown below:

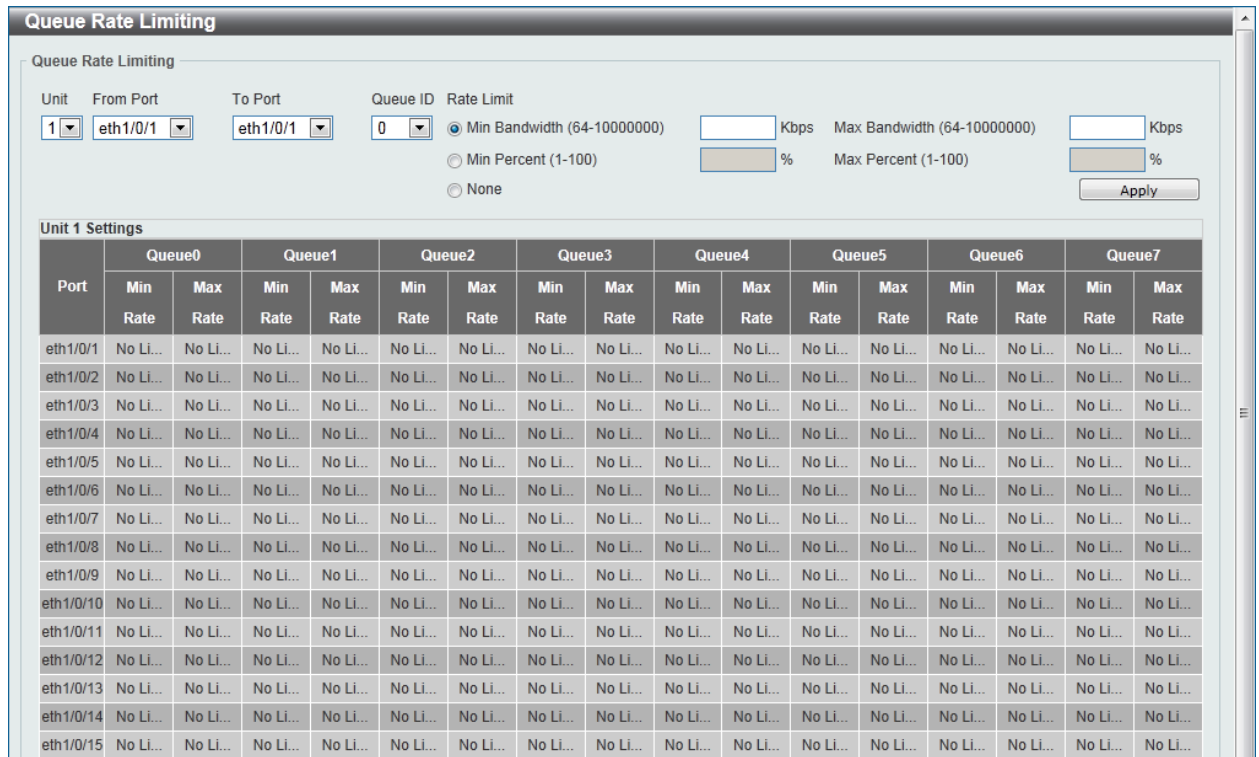

Figure 7-6 Queue Rate Limiting window

The fields that can be configured are described below:

Parameter	Description
Unit	Select the switch unit that will be used for this configuration here.
From Port / To Port	Select the appropriate port range used for the configuration here.
Queue ID	Select the queue ID that will be configured here. Options to choose from are 0 to 7 .
Rate Limit	<p>Select and enter the queue rate limit settings here.</p> <p>When the Min Bandwidth option is selected, enter the minimum bandwidth rate limit value in the space provided. This value must be between 64 and 10000000 kbps. Also enter the maximum bandwidth (Max Bandwidth) rate limit in the space provided. This value must be between 64 and 10000000 kbps. The granularity is 64.</p> <p>When the minimal bandwidth is configured, the packet transmitted from the queue can be guaranteed. When the maximum bandwidth is configured, packets transmitted from the queue cannot exceed the maximum bandwidth even if the bandwidth is available.</p> <p>When configuring the minimal bandwidth, the aggregate of the configured minimum bandwidth must be less than 75 percent of the interface bandwidth to make sure the configured minimal bandwidth can be guaranteed. It is not necessary to set the minimum guaranteed bandwidth for the highest strict priority queue. This is because the traffic in this queue will be serviced first if the minimal bandwidth of all queues is satisfied.</p> <p>The configuration of this command can only be attached to a physical port but not a port-channel. That is the minimum guaranteed bandwidth of one CoS cannot be used across physical ports.</p>

When the **Min Percent** option is selected, enter the minimum bandwidth percentage value in the space provided. This value must be between **1** and **100** percent (%). Also enter the maximum percentage value (**Max Percent**) in the space provided. This value must be between **1** and **100** percent (%).

Click the **Apply** button to accept the changes made.

Advanced Settings

DSCP Mutation Map

This window is used to view and configure the Differentiated Services Code Point (DSCP) mutation map settings. When a packet is received by an interface, based on a DSCP mutation map, the incoming DSCP can be mutated to another DSCP immediately before any QoS operations. The DSCP mutation is helpful to integrate domains with different DSCP assignments. The DSCP-CoS map and DSCP-color map will still be based on the packet's original DSCP. All the subsequent operations will base on the mutated DSCP.

To view the following window, click **QoS > Advanced Settings > DSCP Mutation Map**, as shown below:

Figure 7-7 DSCP Mutation Map window

The fields that can be configured are described below:

Parameter	Description
Mutation Name	Enter the DSCP mutation map name here. This name can be up to 32 characters long.
Input DSCP List	Enter the input DSCP list value here. This value must be between 0 and 63.
Output DSCP	Enter the output DSCP value here. This value must be between 0 and 63.

Click the **Apply** button to accept the changes made.

Click the **Delete** button to remove the specific entry.

Port Trust State and Mutation Binding

This window is used to view and configure port trust state and mutation binding settings.

To view the following window, click **QoS > Advanced Settings > Port Trust State and Mutation Binding**, as shown below:

Port	Trust State	DSCP Mutation Map
eth1/0/1	Trust CoS	
eth1/0/2	Trust CoS	
eth1/0/3	Trust CoS	
eth1/0/4	Trust CoS	
eth1/0/5	Trust CoS	
eth1/0/6	Trust CoS	
eth1/0/7	Trust CoS	
eth1/0/8	Trust CoS	
eth1/0/9	Trust CoS	
eth1/0/10	Trust CoS	
eth1/0/11	Trust CoS	
eth1/0/12	Trust CoS	
eth1/0/13	Trust CoS	
eth1/0/14	Trust CoS	
eth1/0/15	Trust CoS	

Figure 7-8 Port Trust State and Mutation Binding window

The fields that can be configured are described below:

Parameter	Description
Unit	Select the switch unit that will be used for this configuration here.
From Port / To Port	Select the appropriate port range used for the configuration here.
Trust State	Select the port trust state option here. Options to choose from are CoS and DSCP .
DSCP Mutation Map	Select and enter the DSCP mutation map name used here. This name can be up to 32 characters long. Select the None option to not allocate a DSCP mutation map to the port(s).

Click the **Apply** button to accept the changes made.

DSCP CoS Mapping

This window is used to view and configure the DSCP CoS mapping settings.

To view the following window, click **QoS > Advanced Settings > DSCP CoS Mapping**, as shown below:

Figure 7-9 DSCP CoS Mapping window

The fields that can be configured are described below:

Parameter	Description
Unit	Select the switch unit that will be used for this configuration here.
From Port / To Port	Select the appropriate port range used for the configuration here.
CoS	Select the CoS value. Options to choose from are 0 to 7 .
DSCP List	Enter the DSCP list value to map to the CoS value here. This value must be between 0 and 63.

Click the **Apply** button to accept the changes made.

CoS Color Mapping

This window is used to view and configure the CoS color mapping settings.

To view the following window, click **QoS > Advanced Settings > CoS Color Mapping**, as shown below:

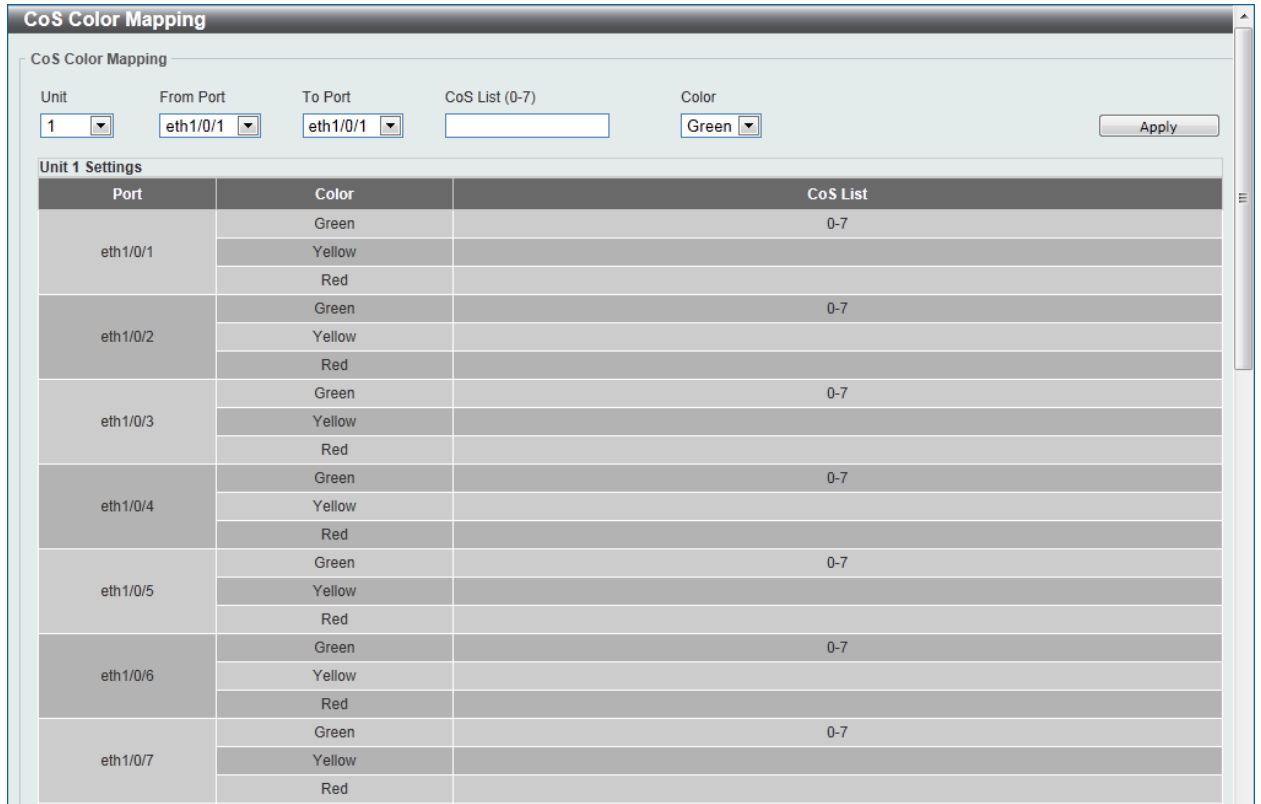

Figure 7-10 CoS Color Mapping window

The fields that can be configured are described below:

Parameter	Description
Unit	Select the switch unit that will be used for this configuration here.
From Port / To Port	Select the appropriate port range used for the configuration here.
CoS List	Enter the CoS value that will be mapped to the color. This value must be between 0 and 7 .
Color	Select the color option. Options to choose from are Green , Yellow , and Red .

Click the **Apply** button to accept the changes made.

DSCP Color Mapping

This window is used to view and configure the DSCP color mapping settings.

To view the following window, click **QoS > Advanced Settings > DSCP Color Mapping**, as shown below:

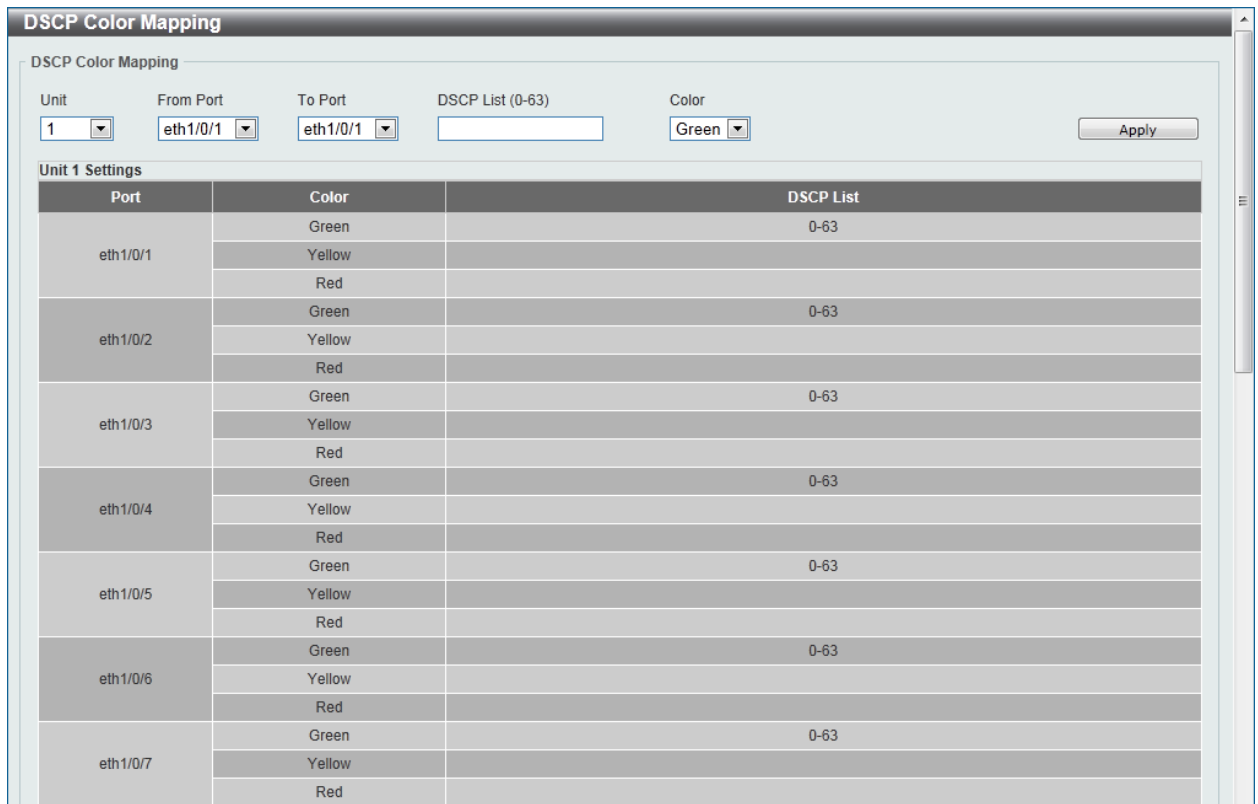

Figure 7-11 DSCP Color Mapping window

The fields that can be configured are described below:

Parameter	Description
Unit	Select the switch unit that will be used for this configuration here.
From Port / To Port	Select the appropriate port range used for the configuration here.
DSCP List	Enter the DSCP list value here that will be mapped to a color. This value must be between 0 and 63.
Color	Select the color option that will be mapped to the DSCP value. Options to choose from are Green , Yellow , and Red .

Click the **Apply** button to accept the changes made.

Class Map

This window is used to view and configure the class map settings.

To view the following window, click **QoS > Advanced Settings > Class Map**, as shown below:



Figure 7-12 Class Map window

The fields that can be configured are described below:

Parameter	Description
Class Map Name	Enter the class map name here. This name can be up to 32 characters long.
Multiple Match Criteria	Select the multiple match criteria option here. Options to choose from are Match All and Match Any .

Click the **Apply** button to accept the changes made.

Click the **Match** button to configure the specific entry.

Click the **Delete** button to remove the specific entry.

Enter a page number and click the **Go** button to navigate to a specific page when multiple pages exist.

After clicking the **Match** button, the following window will appear.

Figure 7-13 Match Rule window

The fields that can be configured are described below:

Parameter	Description
None	Select this option to match nothing to this class map.
Specify	Select the option to match something to this class map.
ACL Name	Select and enter the access list name that will be matched with this class map here. This name can be up to 32 characters long.
CoS List	Select and enter the CoS list value that will be matched with this class map here. This value must be between 0 and 7.
DSCP List	Select and enter the DSCP list value that will be matched with this class map here. This value must be between 0 and 63. Tick the IPv4 only check box to match IPv4 packets only. If not specified, the match is for both IPv4 and IPv6 packets.
Precedence List	Select and enter the precedence list value that will be matched with this class map here. This value must be between 0 and 7. Tick the IPv4 only check box to match IPv4 packets only. If not specified, the match is for both IPv4 and IPv6 packets. For IPv6 packets, the precedence is most three significant bits of traffic class of IPv6 header.
Protocol Name	Select the protocol name that will be matched with the class map here. Options to choose from are None, ARP, BGP, DHCP, DNS, EGP, FTP, IPv4, IPv6, NetBIOS, NFS, NTP, OSPF, PPPOE, RIP, RTSP,

	SSH, Telnet, and TFTP.
VID List	Select and enter the VLAN list value that will be matched with the class map here. This value must be between 1 and 4094.

Click the **Apply** button to accept the changes made.

Click the **Back** button to return to the previous window.

Aggregate Policer

This window is used to view and configure the aggregate policer settings.

To view the following window, click **QoS > Advanced Settings > Aggregate Policer**, as shown below:

Name	Average Rate	Normal Burst Size	Max. Burst Size	Conform Action	Exceed Action	Violate Action	Color Aware
APN-1	100	100		Transmit	Transmit		Disabled

Figure 7-14 Aggregate Policer window

The fields that can be configured are described below:

Parameter	Description
Aggregate Policer Name	Enter the aggregate policer's name here.
Average Rate	Enter the average rate value here. This value must be between 0 and 10000000 kbps.
Normal Burst Size	Enter the normal burst size value here. This value must be between 0 and 16384 Kbytes.
Maximum Burst Size	Enter the maximum burst size value here. This value must be between 0 and 16384 Kbytes.
Confirm Action	<p>Select the confirm action here. The confirm action specifies the action to take on green color packets. If the confirm action is not specified, the default action is to Transmit. Options to choose from are Drop, Set-DSCP-Transmit, Set-1P-Transmit, Transmit, and Set-DSCP-1P.</p> <p>When selecting the Drop option, the packet will be dropped.</p> <p>When selecting the Set-DSCP-Transmit option, enter the IP DSCP value in the space provided. This value sets the IP differentiated services code point (DSCP) value and transmits the packet with the new IP DSCP value.</p> <p>When selecting the Set-1P-Transmit option, enter the 1P transmit value in the space provided. This value sets the 802.1p value and transmits the packet with the new value.</p> <p>When selecting the Set-DSCP-1P option, enter the IP DSCP and 1P transmit values in the spaces provided.</p> <p>When selecting the Transmit option, packets will be transmitted unaltered.</p>

Exceed Action	<p>Select the exceed action here. The exceed action specifies the action to take on packets that exceed the rate limit. For a two rate policer, if the exceed action is not specified, the default action is Drop. Options to choose from are Drop, Set-DSCP-Transmit, Set-1P-Transmit, Transmit, and Set-DSCP-1P.</p> <p>When selecting the Drop option, the packet will be dropped.</p> <p>When selecting the Set-DSCP-Transmit option, enter the IP DSCP value in the space provided. This value sets the IP differentiated services code point (DSCP) value and transmits the packet with the new IP DSCP value.</p> <p>When selecting the Set-1P-Transmit option, enter the 1P transmit value in the space provided. This value sets the 802.1p value and transmits the packet with the new value.</p> <p>When selecting the Set-DSCP-1P option, enter the IP DSCP and 1P transmit values in the spaces provided.</p> <p>When selecting the Transmit option, packets will be transmitted unaltered.</p>
Violate Action	<p>Select the violate action here. The violate action specifies the action to take on packets that violate the normal and maximum burst sizes for single rate policing. It specifies the action to take for those packets that did not conform to both CIR and PIR. For a single rate policer, if the violate action is not specified, it will create a single-rate two-color policer. For a two-rate policer, if the violation action is not specified, the default action is equal to the exceed action. Options to choose from are None, Drop, Set-DSCP-Transmit, Set-1P-Transmit, Transmit, and Set-DSCP-1P.</p> <p>When selecting the Drop option, the packet will be dropped.</p> <p>When selecting the Set-DSCP-Transmit option, enter the IP DSCP value in the space provided. This value sets the IP differentiated services code point (DSCP) value and transmits the packet with the new IP DSCP value.</p> <p>When selecting the Set-1P-Transmit option, enter the 1P transmit value in the space provided. This value sets the 802.1p value and transmits the packet with the new value.</p> <p>When selecting the Set-DSCP-1P option, enter the IP DSCP and 1P transmit values in the spaces provided.</p> <p>When selecting the Transmit option, packets will be transmitted unaltered.</p>
Color Aware	<p>Select this option to enable or disable color aware option here. When color aware is not specified, the policer works in the color blind mode. When color aware is enabled, the policer works in the color aware mode.</p>

Click the **Apply** button to accept the changes made.

Click the **Delete** button to remove the specific entry.

After clicking the **Two Rate Setting** tab, at the top of the page, the following page will be available.

Name	CIR	Confirm Burst	PIR	Peak Burst	Conform Action	Exceed Action	Violate Action	Color Aware	
APN-2	100	100	100	120	Transmit	Drop	Drop	Disabled	Delete

Figure 7-15 Two Rate Settings window

The fields that can be configured are described below:

Parameter	Description
Aggregate Policer Name	Enter the aggregate policer's name here.
CIR	Enter the Committed Information Rate (CIR) value here. This value must be between 0 and 10000000 kbps. The committed packet rate is the first token bucket for the two-rate metering.
Confirm Burst	Enter the confirm burst value here. This value must be between 0 and 16384 Kbytes. The confirm burst value specifies the burst size for the first token bucket in kbps.
PIR	Enter the Peak information Rate (PIR) value here. This value must be between 0 and 10000000 kbps. The peak information rate is the second token bucket for the two-rate metering.
Peak Burst	Enter the peak burst value here. This value must be between 0 and 16384 Kbytes. The peak burst value is the burst size for the second token bucket in kilobytes.
Conform Action	<p>Select the confirm action here. The confirm action specifies the action to take on green color packets. If the confirm action is not specified, the default action is to Transmit. Options to choose from are Drop, Set-DSCP-Transmit, Set-1P-Transmit, Transmit, and Set-DSCP-1P.</p> <p>When selecting the Drop option, the packet will be dropped.</p> <p>When selecting the Set-DSCP-Transmit option, enter the IP DSCP value in the space provided. This value sets the IP differentiated services code point (DSCP) value and transmits the packet with the new IP DSCP value.</p> <p>When selecting the Set-1P-Transmit option, enter the 1P transmit value in the space provided. This value sets the 802.1p value and transmits the packet with the new value.</p> <p>When selecting the Set-DSCP-1P option, enter the IP DSCP and 1P transmit values in the spaces provided.</p> <p>When selecting the Transmit option, packets will be transmitted unaltered.</p>
Exceed Action	<p>Select the exceed action here. The exceed action specifies the action to take on packets that exceed the rate limit. For a two rate policer, if the exceed action is not specified, the default action is Drop. Options to choose from are Drop, Set-DSCP-Transmit, Set-1P-Transmit, Transmit, and Set-DSCP-1P.</p> <p>When selecting the Drop option, the packet will be dropped.</p> <p>When selecting the Set-DSCP-Transmit option, enter the IP DSCP</p>

	<p>value in the space provided. This value sets the IP differentiated services code point (DSCP) value and transmits the packet with the new IP DSCP value.</p> <p>When selecting the Set-1P-Transmit option, enter the 1P transmit value in the space provided. This value sets the 802.1p value and transmits the packet with the new value.</p> <p>When selecting the Set-DSCP-1P option, enter the IP DSCP and 1P transmit values in the spaces provided.</p> <p>When selecting the Transmit option, packets will be transmitted unaltered.</p>
Violate Action	<p>Select the violate action here. The violate action specifies the action to take on packets that violate the normal and maximum burst sizes for single rate policing. It specifies the action to take for those packets that did not conform to both CIR and PIR. For a single rate policer, if the violate action is not specified, it will create a single-rate two-color policer. For a two-rate policer, if the violation action is not specified, the default action is equal to the exceed action. Options to choose from are Drop, Set-DSCP-Transmit, Set-1P-Transmit, Transmit, and Set-DSCP-1P.</p> <p>When selecting the Drop option, the packet will be dropped.</p> <p>When selecting the Set-DSCP-Transmit option, enter the IP DSCP value in the space provided. This value sets the IP differentiated services code point (DSCP) value and transmits the packet with the new IP DSCP value.</p> <p>When selecting the Set-1P-Transmit option, enter the 1P transmit value in the space provided. This value sets the 802.1p value and transmits the packet with the new value.</p> <p>When selecting the Set-DSCP-1P option, enter the IP DSCP and 1P transmit values in the spaces provided.</p> <p>When selecting the Transmit option, packets will be transmitted unaltered.</p>
Color Aware	<p>Select this option to enable or disable color aware option here. When color aware is not specified, the policer works in the color blind mode. When color aware is enabled, the policer works in the color aware mode.</p>

Click the **Apply** button to accept the changes made.

Click the **Delete** button to remove the specific entry.

Policy Map

This window is used to view and configure the policy map settings.

To view the following window, click **QoS > Advanced Settings > Policy Map**, as shown below:

Figure 7-16 Policy Map window

The fields that can be configured for **Create/Delete Policy Map** are described below:

Parameter	Description
Policy Map Name	Enter the policy map's name here that will be created or deleted. This name can be up to 32 characters long.

Click the **Apply** button to accept the changes made.

The fields that can be configured for **Traffic Policy** are described below:

Parameter	Description
Policy Map Name	Enter the policy map's name here. This name can be up to 32 characters long.
Class Map Name	Enter the class map's name here. This name can be up to 32 characters long.

Click the **Apply** button to accept the changes made.

Click the **Delete** button to remove the specific entry.

Enter a page number and click the **Go** button to navigate to a specific page when multiple pages exist.

To view the rules of a specific policy map, click the policy map name in the table (the Policy Map Name will toggle to the bold font).

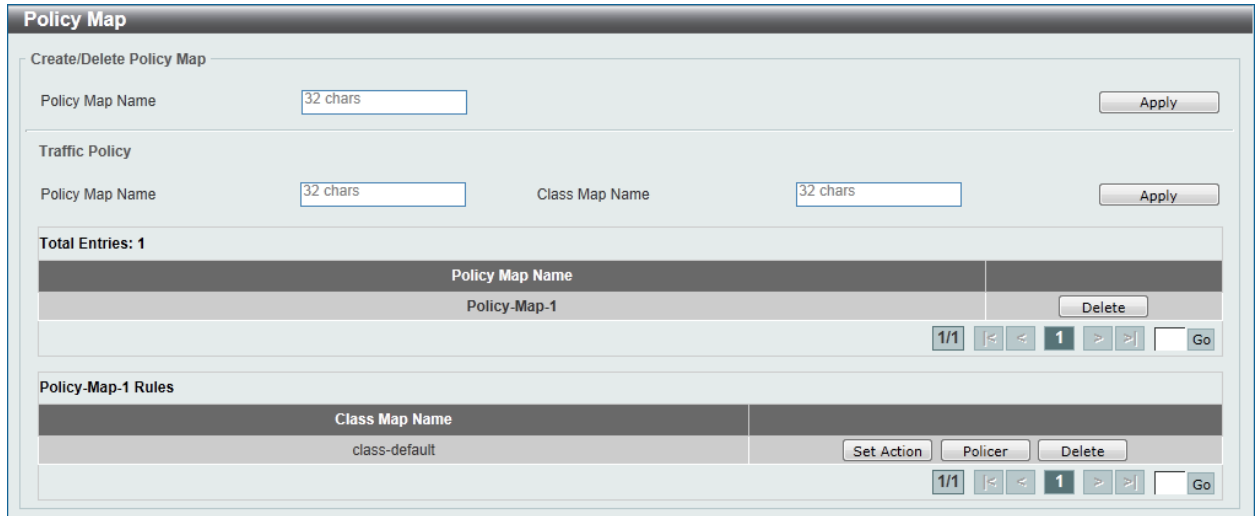

Figure 7-17 Policy Map (View Rules) window

Click the **Set Action** button to configure the action for the policy map.

Click the **Policer** button to configure the policer action for the policy map.

Click the **Delete** button to remove the specific entry.

After clicking the **Set Action** button, the following window will appear.

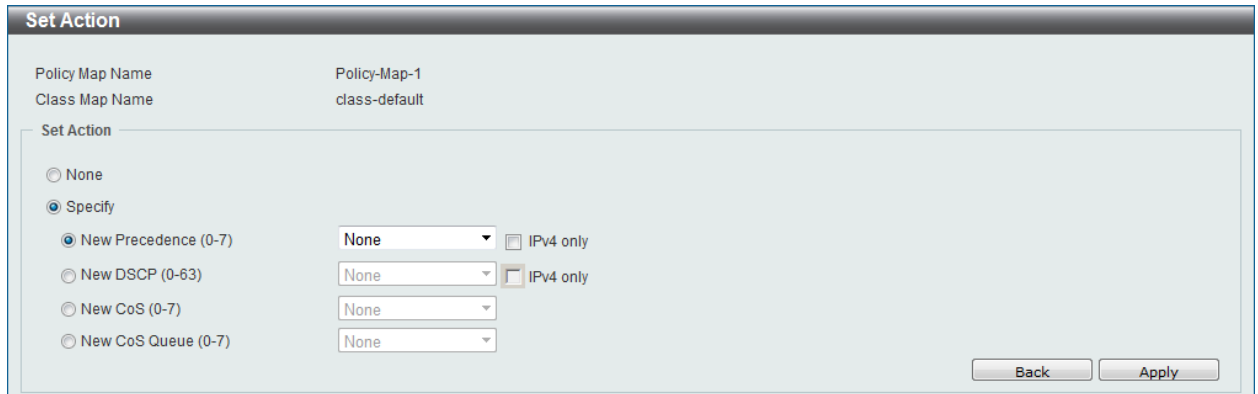

Figure 7-18 Set Action window

The fields that can be configured are described below:

Parameter	Description
None	Select this option to match nothing to this policy map.
Specify	Select the option to match something to this policy map.
New Precedence	Select a new precedence for the packet. This value must be between 0 and 7. Tick the IPv4 only to only mark IPv4 precedence. Setting the precedence will not affect the CoS queue selection.
New DSCP	Select a new DSCP for the packet. This value must be between 0 and 63. Tick the IPv4 only to only mark IPv4 precedence. Setting DSCP will not affect the CoS queue selection.
New CoS	Select a new CoS value for the packet. This value must be between 0 and 7. Setting CoS will not affect the CoS queue selection.
New CoS Queue	Select a new CoS queue for the packet. This value must be between 0

and 7. This overwrites the original CoS queue selection.

Click the **Apply** button to accept the changes made.

Click the **Back** button to return to the previous window.

After clicking the **Policer** button, the following window will appear.

Figure 7-19 Police Action window

The fields that can be configured are described below:

Parameter	Description
None	Select this option to match nothing to this policy map.
Specify	Select the option to match something to this policy map.
Average Rate	Enter the average rate in kilobits per second.
Normal Burst Size	Enter the normal burst size in kilobytes.
Maximum Burst Size	Enter the maximum burst in kilobytes.
Conform Action	Select the action to take on green color packets. Options to choose from are Drop , Set-DSCP-Transmit , Set-1P-Transmit , Transmit , and Set-DSCP-1P .
Exceed Action	Select the action to take on yellow color packets. Options to choose from are Drop , Set-DSCP-Transmit , Set-1P-Transmit , Transmit , and Set-DSCP-1P .
Violate Action	Select the action to take on red color packets. Options to choose from are None , Drop , Set-DSCP-Transmit , Set-1P-Transmit , Transmit , and Set-DSCP-1P .
Color Aware	Select this option to enable or disable color aware mode.

Click the **Apply** button to accept the changes made.

Click the **Back** button to return to the previous window.

Policy Binding

This window is used to view and configure the policy binding settings.

To view the following window, click **QoS > Advanced Settings > Policy Binding**, as shown below:

Policy Binding

Policy Binding Setting

Unit: 1 | From Port: eth1/0/1 | To Port: eth1/0/1 | Direction: Input | Policy Map Name: 32 chars None

Port	Direction	Policy Map Name
eth1/0/1		
eth1/0/2		
eth1/0/3		
eth1/0/4		
eth1/0/5		
eth1/0/6		
eth1/0/7		
eth1/0/8		
eth1/0/9		
eth1/0/10		
eth1/0/11		
eth1/0/12		
eth1/0/13		
eth1/0/14		
eth1/0/15		

Figure 7-20 Policy Binding window

The fields that can be configured are described below:

Parameter	Description
Unit	Select the switch unit that will be used for this configuration here.
From Port / To Port	Select the appropriate port range used for the configuration here.
Direction	Select the direction option here. Option to choose from is Input . Input represents Input specified ingress traffic.
Policy Map Name	Enter the policy map name here. This name can be up to 32 characters long. Select the None option to not tie a policy map to this entry.

Click the **Apply** button to accept the changes made.

8. Access Control List (ACL)

ACL Configuration Wizard
ACL Access List
ACL Interface Access Group
ACL VLAN Access Map
ACL VLAN Filter

ACL Configuration Wizard

This window is used to guide the user to create a new ACL access list or configure an existing ACL access list.

To view the following window, click **ACL > ACL Configuration Wizard**, as shown below:

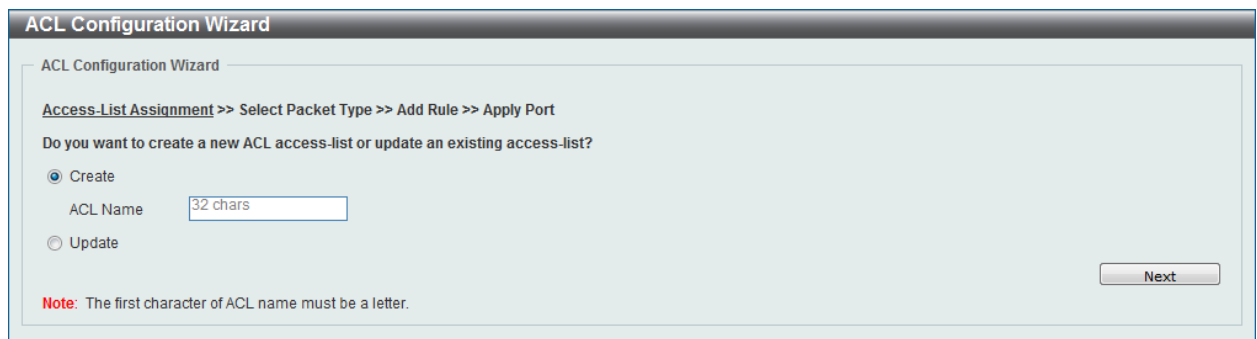
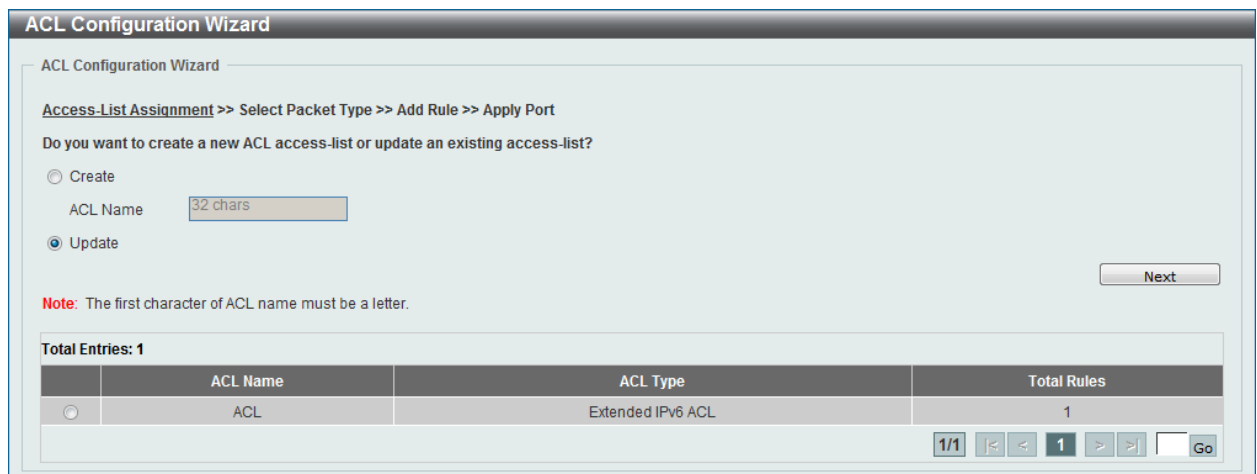

Figure 8-1 ACL Configuration Wizard (Access-List Assignment) - Create window



ACL Name	ACL Type	Total Rules
ACL	Extended IPv6 ACL	1

Figure 8-2 ACL Configuration Wizard (Access-List Assignment) - Update window

The fields that can be configured are described below:

Parameter	Description
Create	Select and enter the ACL name with a maximum of 32 characters.
Update	Select to see a table below with the existing ACL access lists. Select the specific re-configure the entry.

Click the **Next** button to continue.

Enter a page number and click the **Go** button to navigate to a specific page when multiple pages exist.

After clicking the **Next** button, the following window will appear.

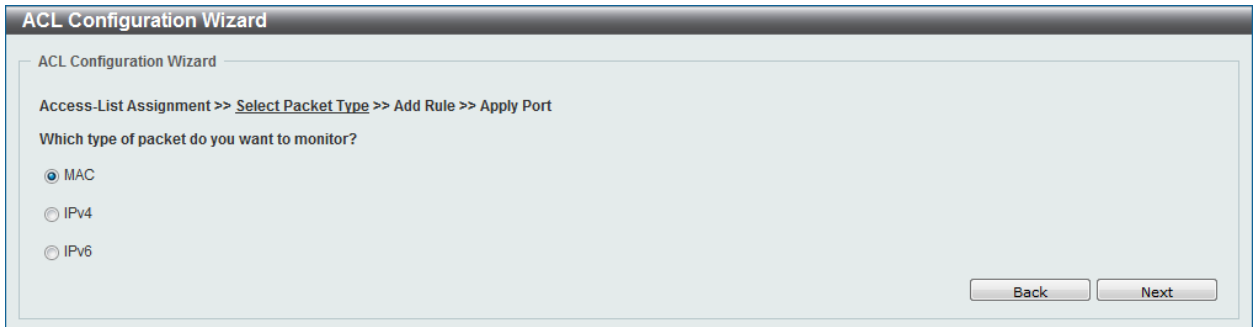

ACL Configuration Wizard

Access-List Assignment >> Select Packet Type >> Add Rule >> Apply Port

Which type of packet do you want to monitor?

MAC

IPv4

IPv6

Back Next

Figure 8-3 ACL Configuration Wizard (Select Packet Type) window

The fields that can be configured are described below:

Parameter	Description
MAC	Select to be MAC ACL.
IPv4	Select to be IPv4 ACL.
IPv6	Select to be IPv6 ACL.

Click the **Back** button to return to the previous window.

Click the **Next** button to continue.

After clicking the **MAC** radio button and the **Next** button, the following window will appear.

Figure 8-4 ACL Configuration Wizard (Add Rule for MAC ACL) window

The fields that can be configured are described below:

Parameter	Description
Sequence No.	Enter the ACL rule number here. This value must be between 1 and 65535. Select Auto Assign to automatically generate an ACL rule number for this entry.
Source	Select and enter the source information here. Options to choose from are Any , Host , and MAC . When the Any option is selected, any source traffic will be evaluated according to the conditions of this rule. When the Host option is selected, enter the source host's MAC address here. When the MAC option is selected, the Wildcard option will also be available. Enter the source MAC address and wildcard value in the spaces provided.
Destination	Select and enter the destination information here. Options to choose from are Any , Host , and MAC . When the Any option is selected, any destination traffic will be evaluated according to the conditions of this rule. When the Host option is selected, enter the destination host's MAC address here. When the MAC option is selected, the Wildcard option will also be available. Enter the destination MAC address and wildcard value in the spaces provided.
Specify Ethernet Type	Select the Ethernet type option here. Options to choose from are aarp , appletalk , decent-iv , etype-6000 , etype-8042 , lat , lavc-sca , mop-console , mop-dump , vines-echo , vines-ip , xns-idp , and arp .
Ethernet Type	Enter the Ethernet type hexadecimal value here. This value must be between 0x600 and 0xFFFF. When any Ethernet type profile is selected in the Specify Ethernet Type drop-down list, the appropriate

	hexadecimal value will automatically be entered.
Ethernet Type Mask	Enter the Ethernet type mask hexadecimal value here. This value must be between 0x0 and 0xFFFF. When any Ethernet type profile is selected in the Specify Ethernet Type drop-down list, the appropriate hexadecimal value will automatically be entered.
CoS	Select the CoS value used here. This value is between 0 and 7 .
VID	Enter the VLAN ID that will be associated with this ACL rule here. This value must be between 1 and 4094.
Time Range	Enter the name of the time range to associate with this ACL rule.
Action	Select the action that this rule will take here. Options to choose from are Permit and Deny .

Click the **Back** button to return to the previous window.

Click the **Next** button to continue.

After clicking the **IPv4** radio button and the **Next** button, the following window will appear.

Figure 8-5 ACL Configuration Wizard (Add Rule for IPv4 ACL) window

This window has a dynamic section. Every selection made in the **Protocol Type** drop-down list will change the bottom part of this window.

The **fixed** fields that can be configured are described below:

Parameter	Description
Sequence No.	Enter the ACL rule number here. This value must be between 1 and 65535. Select Auto Assign to automatically generate an ACL rule number for this entry.
Protocol Type	Select the protocol type option here. Options to choose from are TCP , UDP , ICMP , EIGRP , ESP , GRE , IGMP , OSPF , PIM , VRRP , IP-in-IP , PCP , Protocol ID , and None .

After selecting the **TCP** option as the **Protocol Type**, the following section will appear.

The screenshot shows the 'ACL Configuration Wizard' interface. At the top, it says 'Access-List Assignment >> Select Packet Type >> Add Rule >> Apply Port'. Below this, it prompts the user to 'Please assign a sequence number to create a new rule.' There are two radio buttons: 'Sequence No. (1-65535)' (selected) and 'Auto Assign'. A text input field is next to the 'Sequence No.' option. Below that, 'Protocol Type' is set to 'TCP' with a dropdown menu and a range '(0-255)'. There is also a 'Fragments' checkbox which is unchecked. The main section is titled 'Assign rule criteria' and contains four sub-sections: 'IPv4 Address', 'Port', 'IPv4 DSCP', and 'TCP Flag'. Each sub-section has several options and input fields. At the bottom right, there are 'Back' and 'Next' buttons.

Figure 8-6 ACL Configuration Wizard (Add Rule for IPv4 ACL) TCP window

The **dynamic** fields that can be configured are described below:

Parameter	Description
Source	Select and enter the source information here. Options to choose from are Any , Host , and IP . When the Any option is selected, any source traffic will be evaluated according to the conditions of this rule. When the Host option is selected, enter the source host's IP address here. When the IP option is selected, the Wildcard option will also be available. Enter the group of source IP addresses by using a wildcard bitmap. The bit corresponding to the bit value 1 will be ignored. The bit corresponding to the bit value 0 will be checked.
Destination	Select and enter the destination information here. Options to choose from are Any , Host , and IP . When the Any option is selected, any destination traffic will be evaluated according to the conditions of this rule. When the Host option is selected, enter the destination host's IP address here. When the IP option is selected, the Wildcard option will also be available. Enter the group of destination IP addresses by using a wildcard bitmap. The bit corresponding to the bit value 1 will be ignored. The bit corresponding to the bit value 0 will be checked.
Source Port	Select and enter the source port value here. Options to choose from are = , > , < , ≠ , and Range . When selecting the = option, the specific selected port number will be used. When selecting the > option, all ports greater than the selected port, will be used. When selecting the < option, all ports smaller than the selected port, will be used. When selecting the ≠ option, all ports, excluding the selected port, will be used. When selecting the Range option, the start port number and end port number selected, of the range, will be used. Alternatively, the port number(s) can manually be entered in the space(s) provided, if the

	port number(s) is/are not available in the drop-down list.
Destination Port	Select and enter the destination port value here. Options to choose from are =, >, <, ≠, and Range . When selecting the = option, the specific selected port number will be used. When selecting the > option, all ports greater than the selected port, will be used. When selecting the < option, all ports smaller than the selected port, will be used. When selecting the ≠ option, all ports, excluding the selected port, will be used. When selecting the Range option, the start port number and end port number selected, of the range, will be used. Alternatively, the port number(s) can manually be entered in the space(s) provided, if the port number(s) is/are not available in the drop-down list.
IP Precedence	Select the IP precedence value used here. Options to choose from are 0 (routine) , 1 (priority) , 2, (immediate) , 3 (flash) , 4 (flash-override) , 5 (critical) , 6 (internet) , and 7 (network) .
ToS	After selecting the IP precedence value, select the Type-of-Service (ToS) value that will be used here. Options to choose from are 0 (normal) , 1 (min-monetary-cost) , 2 (max-reliability) , 3, 4 (max-throughput) , 5, 6, 7, 8 (min-delay) , 9, 10, 11, 12, 13, 14, and 15 .
DSCP	Select or enter the DSCP value used here. This value must be between 0 and 63.
TCP Flag	Tick the appropriate TCP flag option to include the flag in this rule. Options to choose from are ack , fin , psh , rst , syn , and urg .
Time Range	Enter the name of the time range to associate with this ACL rule.
Action	Select the action that this rule will take here. Options to choose from are Permit and Deny .

After selecting the **UDP** option as the **Protocol Type**, the following section will appear.

The screenshot shows the 'ACL Configuration Wizard' interface. At the top, it indicates the current step: 'Access-List Assignment >> Select Packet Type >> Add Rule >> Apply Port'. Below this, it prompts the user to 'Please assign a sequence number to create a new rule.' There are two options: 'Sequence No. (1-65535)' with an input field, and 'Auto Assign'. The 'Protocol Type' is set to 'UDP' in a dropdown menu, with a range '(0-255)' and a 'Fragments' checkbox. The 'Assign rule criteria' section is expanded, showing three tabs: 'IPv4 Address', 'Port', and 'IPv4 DSCP'. Under 'IPv4 Address', there are radio buttons for 'Any', 'Host', and 'IP', each with a corresponding 'Wildcard' input field. The 'Port' section has 'Source Port' and 'Destination Port' dropdowns, each followed by two input fields for port ranges. The 'IPv4 DSCP' section has radio buttons for 'IP Precedence' and 'DSCP (0-63)', with 'IP Precedence' selected and having 'Please Select' dropdowns for 'ToS'. There is also a 'Time Range' input field set to '32 chars' and an 'Action' section with 'Permit' selected and 'Deny' as an option. 'Back' and 'Next' buttons are at the bottom right.

Figure 8-7 ACL Configuration Wizard (Add Rule for IPv4 ACL) UDP window

The **dynamic** fields that can be configured are described below:

Parameter	Description
Source	Select and enter the source information here. Options to choose from are Any , Host , and IP . When the Any option is selected, any source traffic will be evaluated according to the conditions of this rule. When the Host option is selected, enter the source host's IP address here. When the IP option is selected, the Wildcard option will also be available. Enter the group of source IP addresses by using a wildcard bitmap. The bit corresponding to the bit value 1 will be ignored. The bit corresponding to the bit value 0 will be checked.
Destination	Select and enter the destination information here. Options to choose from are Any , Host , and IP . When the Any option is selected, any destination traffic will be evaluated according to the conditions of this rule. When the Host option is selected, enter the destination host's IP address here. When the IP option is selected, the Wildcard option will also be available. Enter the group of destination IP addresses by using a wildcard bitmap. The bit corresponding to the bit value 1 will be ignored. The bit corresponding to the bit value 0 will be checked.
Source Port	Select and enter the source port value here. Options to choose from are = , > , < , ≠ , and Range . When selecting the = option, the specific selected port number will be used. When selecting the > option, all ports greater than the selected port, will be used. When selecting the < option, all ports smaller than the selected port, will be used. When selecting the ≠ option, all ports, excluding the selected port, will be

	used. When selecting the Range option, the start port number and end port number selected, of the range, will be used. Alternatively, the port number(s) can manually be entered in the space(s) provided, if the port number(s) is/are not available in the drop-down list.
Destination Port	Select and enter the destination port value here. Options to choose from are =, >, <, ≠, and Range . When selecting the = option, the specific selected port number will be used. When selecting the > option, all ports greater than the selected port, will be used. When selecting the < option, all ports smaller than the selected port, will be used. When selecting the ≠ option, all ports, excluding the selected port, will be used. When selecting the Range option, the start port number and end port number selected, of the range, will be used. Alternatively, the port number(s) can manually be entered in the space(s) provided, if the port number(s) is/are not available in the drop-down list.
IP Precedence	Select the IP precedence value used here. Options to choose from are 0 (routine) , 1 (priority) , 2 (immediate) , 3 (flash) , 4 (flash-override) , 5 (critical) , 6 (internet) , and 7 (network) .
ToS	After selecting the IP precedence value, select the Type-of-Service (ToS) value that will be used here. Options to choose from are 0 (normal) , 1 (min-monetary-cost) , 2 (max-reliability) , 3, 4 (max-throughput) , 5, 6, 7, 8 (min-delay) , 9, 10, 11, 12, 13, 14 , and 15 .
DSCP	Select or enter the DSCP value used here. This value must be between 0 and 63.
Time Range	Enter the name of the time range to associate with this ACL rule.
Action	Select the action that this rule will take here. Options to choose from are Permit and Deny .

After selecting the **ICMP** option as the **Protocol Type**, the following section will appear.

The screenshot shows the 'ACL Configuration Wizard' interface. At the top, it indicates the current step: 'Access-List Assignment >> Select Packet Type >> Add Rule >> Apply Port'. Below this, it prompts the user to 'Please assign a sequence number to create a new rule.' There are two options: 'Sequence No. (1-65535)' with an input field and 'Auto Assign'. The 'Protocol Type' is set to 'ICMP' with a dropdown menu, and there is an input field for '(0-255)' and a checkbox for 'Fragments'. The 'Assign rule criteria' section has three tabs: 'IPv4 Address', 'ICMP', and 'IPv4 DSCP'. Under 'IPv4 Address', there are sections for 'Source' and 'Destination', each with radio buttons for 'Any', 'Host', and 'IP', and input fields for 'Wildcard'. The 'ICMP' section has a dropdown for 'Specify ICMP Message Type' (set to 'Please Select'), and input fields for 'ICMP Message Type (0-255)' and 'Message Code (0-255)'. The 'IPv4 DSCP' section has radio buttons for 'IP Precedence' and 'DSCP (0-63)', with dropdowns for 'Please Select' and 'ToS Please Select'. There is also a 'Time Range' input field set to '32 chars' and an 'Action' section with radio buttons for 'Permit' and 'Deny'. At the bottom right, there are 'Back' and 'Next' buttons.

Figure 8-8 ACL Configuration Wizard (Add Rule for IPv4 ACL) ICMP window

The **dynamic** fields that can be configured are described below:

Parameter	Description
Source	Select and enter the source information here. Options to choose from are Any , Host , and IP . When the Any option is selected, any source traffic will be evaluated according to the conditions of this rule. When the Host option is selected, enter the source host's IP address here. When the IP option is selected, the Wildcard option will also be available. Enter the group of source IP addresses by using a wildcard bitmap. The bit corresponding to the bit value 1 will be ignored. The bit corresponding to the bit value 0 will be checked.
Destination	Select and enter the destination information here. Options to choose from are Any , Host , and IP . When the Any option is selected, any destination traffic will be evaluated according to the conditions of this rule. When the Host option is selected, enter the destination host's IP address here. When the IP option is selected, the Wildcard option will also be available. Enter the group of destination IP addresses by using a wildcard bitmap. The bit corresponding to the bit value 1 will be ignored. The bit corresponding to the bit value 0 will be checked.
Specify ICMP Message Type	Select the ICMP message type used here.
ICMP Message Type	When the ICMP Message Type is not selected, enter the ICMP Message Type numerical value used here. When the ICMP Message Type is selected, this numerical value will automatically be entered.
Message Code	When the ICMP Message Type is not selected, enter the Message Code numerical value used here. When the ICMP Message Type is selected, this numerical value will automatically be entered.

IP Precedence	Select the IP precedence value used here. Options to choose from are 0 (routine) , 1 (priority) , 2 (immediate) , 3 (flash) , 4 (flash-override) , 5 (critical) , 6 (internet) , and 7 (network) .
ToS	After selecting the IP precedence value, select the Type-of-Service (ToS) value that will be used here. Options to choose from are 0 (normal) , 1 (min-monetary-cost) , 2 (max-reliability) , 3, 4 (max-throughput) , 5, 6, 7, 8 (min-delay) , 9, 10, 11, 12, 13, 14 , and 15 .
DSCP	Select or enter the DSCP value used here. This value must be between 0 and 63.
Time Range	Enter the name of the time range to associate with this ACL rule.
Action	Select the action that this rule will take here. Options to choose from are Permit and Deny .

After selecting the **EIGRP** option as the **Protocol Type**, the following section will appear.

ACL Configuration Wizard

Access-List Assignment >> Select Packet Type >> [Add Rule](#) >> Apply Port

Please assign a sequence number to create a new rule.

Sequence No. (1-65535) Auto Assign

Protocol Type: EIGRP (0-255) Fragments

Assign rule criteria

IPv4 Address **IPv4 DSCP**

IPv4 Address

Any Host IP

Source: Host IP

Destination: Host IP

Wildcard:

IPv4 DSCP

IP Precedence ToS

DSCP (0-63)

Time Range:

Action: Permit Deny

Figure 8-9 ACL Configuration Wizard (Add Rule for IPv4 ACL) EIGRP window

The **dynamic** fields that can be configured are described below:

Parameter	Description
Fragments	Select the Fragments option to include packet fragment filtering.
Source	Select and enter the source information here. Options to choose from are Any , Host , and IP . When the Any option is selected, any source traffic will be evaluated according to the conditions of this rule. When the Host option is selected, enter the source host's IP address here. When the IP option is selected, the Wildcard option will also be available. Enter the group of source IP addresses by using a wildcard bitmap. The bit corresponding to the bit value 1 will be ignored. The bit corresponding to the bit value 0 will be checked.
Destination	Select and enter the destination information here. Options to choose

	from are Any , Host , and IP . When the Any option is selected, any destination traffic will be evaluated according to the conditions of this rule. When the Host option is selected, enter the destination host's IP address here. When the IP option is selected, the Wildcard option will also be available. Enter the group of destination IP addresses by using a wildcard bitmap. The bit corresponding to the bit value 1 will be ignored. The bit corresponding to the bit value 0 will be checked.
IP Precedence	Select the IP precedence value used here. Options to choose from are 0 (routine) , 1 (priority) , 2 (immediate) , 3 (flash) , 4 (flash-override) , 5 (critical) , 6 (internet) , and 7 (network) .
ToS	After selecting the IP precedence value, select the Type-of-Service (ToS) value that will be used here. Options to choose from are 0 (normal) , 1 (min-monetary-cost) , 2 (max-reliability) , 3, 4 (max-throughput) , 5, 6, 7, 8 (min-delay) , 9, 10, 11, 12, 13, 14 , and 15 .
DSCP	Select or enter the DSCP value used here. This value must be between 0 and 63.
Time Range	Enter the name of the time range to associate with this ACL rule.
Action	Select the action that this rule will take here. Options to choose from are Permit and Deny .

After selecting the **ESP** option as the **Protocol Type**, the following section will appear.

The screenshot shows the 'ACL Configuration Wizard' window. The title bar reads 'ACL Configuration Wizard'. Below the title bar, the breadcrumb path is 'Access-List Assignment >> Select Packet Type >> Add Rule >> Apply Port'. The main content area is titled 'Please assign a sequence number to create a new rule.' and contains the following fields and options:

- Sequence No. (1-65535)**: A radio button is selected, with an adjacent text input field.
- Auto Assign**: An unselected radio button.
- Protocol Type**: A dropdown menu set to 'ESP', followed by a text input field containing '50' and a range '(0-255)'. A checkbox for 'Fragments' is present and unchecked.
- Assign rule criteria**: A section with two tabs: 'IPv4 Address' and 'IPv4 DSCP'.
 - IPv4 Address**: Contains 'Source' and 'Destination' sections. Each has radio buttons for 'Any', 'Host', and 'IP'. Below 'IP' is a 'Wildcard' text input field.
 - IPv4 DSCP**: Contains radio buttons for 'IP Precedence' (selected) and 'DSCP (0-63)'. 'IP Precedence' has a 'Please Select' dropdown and a 'ToS' dropdown. 'DSCP (0-63)' has a 'Please Select' dropdown and a text input field.
- Time Range**: A text input field containing '32 chars'.
- Action**: Radio buttons for 'Permit' (selected) and 'Deny'.
- Navigation**: 'Back' and 'Next' buttons at the bottom right.

Figure 8-10 ACL Configuration Wizard (Add Rule for IPv4 ACL) ESP window

The **dynamic** fields that can be configured are described below:

Parameter	Description
Fragments	Select the Fragments option to include packet fragment filtering.
Source	Select and enter the source information here. Options to choose from are Any , Host , and IP . When the Any option is selected, any source traffic will be evaluated according to the conditions of this rule. When

	the Host option is selected, enter the source host's IP address here. When the IP option is selected, the Wildcard option will also be available. Enter the group of source IP addresses by using a wildcard bitmap. The bit corresponding to the bit value 1 will be ignored. The bit corresponding to the bit value 0 will be checked.
Destination	Select and enter the destination information here. Options to choose from are Any , Host , and IP . When the Any option is selected, any destination traffic will be evaluated according to the conditions of this rule. When the Host option is selected, enter the destination host's IP address here. When the IP option is selected, the Wildcard option will also be available. Enter the group of destination IP addresses by using a wildcard bitmap. The bit corresponding to the bit value 1 will be ignored. The bit corresponding to the bit value 0 will be checked.
IP Precedence	Select the IP precedence value used here. Options to choose from are 0 (routine) , 1 (priority) , 2, (immediate) , 3 (flash) , 4 (flash-override) , 5 (critical) , 6 (internet) , and 7 (network) .
ToS	After selecting the IP precedence value, select the Type-of-Service (ToS) value that will be used here. Options to choose from are 0 (normal) , 1 (min-monetary-cost) , 2 (max-reliability) , 3, 4 (max-throughput) , 5, 6, 7, 8 (min-delay) , 9, 10, 11, 12, 13, 14, and 15 .
DSCP	Select or enter the DSCP value used here. This value must be between 0 and 63.
Time Range	Enter the name of the time range to associate with this ACL rule.
Action	Select the action that this rule will take here. Options to choose from are Permit and Deny .

After selecting the **GRE** option as the **Protocol Type**, the following section will appear.

The screenshot shows the 'ACL Configuration Wizard' interface. At the top, it says 'Access-List Assignment >> Select Packet Type >> Add Rule >> Apply Port'. Below this, it prompts the user to 'Please assign a sequence number to create a new rule.' There are two radio buttons: 'Sequence No. (1-65535)' (selected) and 'Auto Assign'. A text box contains '47'. Below that, 'Protocol Type' is set to 'GRE' in a dropdown menu, with a text box containing '47' and '(0-255)' next to it. There is also a 'Fragments' checkbox which is unchecked. The 'Assign rule criteria' section has two tabs: 'IPv4 Address' (selected) and 'IPv4 DSCP'. Under 'IPv4 Address', there are two columns: 'Source' and 'Destination'. Each column has three radio buttons: 'Any' (selected), 'Host', and 'IP'. Below each radio button is a text box for 'Wildcard'. Under 'IPv4 DSCP', there are two radio buttons: 'IP Precedence' (selected) and 'DSCP (0-63)'. Both have a 'Please Select' dropdown menu. Below that is a 'Time Range' text box containing '32 chars'. At the bottom, there are two radio buttons: 'Permit' (selected) and 'Deny'. 'Back' and 'Next' buttons are at the bottom right.

Figure 8-11 ACL Configuration Wizard (Add Rule for IPv4 ACL) GRE window

The **dynamic** fields that can be configured are described below:

Parameter	Description
Fragments	Select the Fragments option to include packet fragment filtering.
Source	Select and enter the source information here. Options to choose from are Any , Host , and IP . When the Any option is selected, any source traffic will be evaluated according to the conditions of this rule. When the Host option is selected, enter the source host's IP address here. When the IP option is selected, the Wildcard option will also be available. Enter the group of source IP addresses by using a wildcard bitmap. The bit corresponding to the bit value 1 will be ignored. The bit corresponding to the bit value 0 will be checked.
Destination	Select and enter the destination information here. Options to choose from are Any , Host , and IP . When the Any option is selected, any destination traffic will be evaluated according to the conditions of this rule. When the Host option is selected, enter the destination host's IP address here. When the IP option is selected, the Wildcard option will also be available. Enter the group of destination IP addresses by using a wildcard bitmap. The bit corresponding to the bit value 1 will be ignored. The bit corresponding to the bit value 0 will be checked.
IP Precedence	Select the IP precedence value used here. Options to choose from are 0 (routine) , 1 (priority) , 2 (immediate) , 3 (flash) , 4 (flash-override) , 5 (critical) , 6 (internet) , and 7 (network) .
ToS	After selecting the IP precedence value, select the Type-of-Service (ToS) value that will be used here. Options to choose from are 0 (normal) , 1 (min-monetary-cost) , 2 (max-reliability) , 3, 4 (max-throughput) , 5, 6, 7, 8 (min-delay) , 9, 10, 11, 12, 13, 14, and 15 .
DSCP	Select or enter the DSCP value used here. This value must be between 0 and 63.
Time Range	Enter the name of the time range to associate with this ACL rule.
Action	Select the action that this rule will take here. Options to choose from are Permit and Deny .

After selecting the **IGMP** option as the **Protocol Type**, the following section will appear.

ACL Configuration Wizard

Access-List Assignment >> Select Packet Type >> Add Rule >> Apply Port

Please assign a sequence number to create a new rule.

Sequence No. (1-65535) Auto Assign

Protocol Type **IGMP** (0-255) Fragments

Assign rule criteria

IPv4 Address **IPv4 DSCP**

IPv4 Address

Any Host IP

Source Destination

IPv4 DSCP

IP Precedence ToS

DSCP (0-63)

Time Range

Action Permit Deny

Figure 8-12 ACL Configuration Wizard (Add Rule for IPv4 ACL) IGMP window

The **dynamic** fields that can be configured are described below:

Parameter	Description
Fragments	Select the Fragments option to include packet fragment filtering.
Source	Select and enter the source information here. Options to choose from are Any , Host , and IP . When the Any option is selected, any source traffic will be evaluated according to the conditions of this rule. When the Host option is selected, enter the source host's IP address here. When the IP option is selected, the Wildcard option will also be available. Enter the group of source IP addresses by using a wildcard bitmap. The bit corresponding to the bit value 1 will be ignored. The bit corresponding to the bit value 0 will be checked.
Destination	Select and enter the destination information here. Options to choose from are Any , Host , and IP . When the Any option is selected, any destination traffic will be evaluated according to the conditions of this rule. When the Host option is selected, enter the destination host's IP address here. When the IP option is selected, the Wildcard option will also be available. Enter the group of destination IP addresses by using a wildcard bitmap. The bit corresponding to the bit value 1 will be ignored. The bit corresponding to the bit value 0 will be checked.
IP Precedence	Select the IP precedence value used here. Options to choose from are 0 (routine) , 1 (priority) , 2, (immediate) , 3 (flash) , 4 (flash-override) , 5 (critical) , 6 (internet) , and 7 (network) .
ToS	After selecting the IP precedence value, select the Type-of-Service (ToS) value that will be used here. Options to choose from are 0 (normal) , 1 (min-monetary-cost) , 2 (max-reliability) , 3, 4 (max-throughput) , 5, 6, 7, 8 (min-delay) , 9, 10, 11, 12, 13, 14 , and 15 .
DSCP	Select or enter the DSCP value used here. This value must be

	between 0 and 63.
Time Range	Enter the name of the time range to associate with this ACL rule.
Action	Select the action that this rule will take here. Options to choose from are Permit and Deny .

After selecting the **OSPF** option as the **Protocol Type**, the following section will appear.

The screenshot shows the 'ACL Configuration Wizard' window. At the top, it says 'Access-List Assignment >> Select Packet Type >> Add Rule >> Apply Port'. Below this, it prompts the user to 'Please assign a sequence number to create a new rule.' There are two radio buttons: 'Sequence No. (1-65535)' (selected) and 'Auto Assign'. A text box contains '89'. Below that, 'Protocol Type' is set to 'OSPF' in a dropdown menu, with a range '(0-255)' and a 'Fragments' checkbox. The 'Assign rule criteria' section has two tabs: 'IPv4 Address' and 'IPv4 DSCP'. Under 'IPv4 Address', there are radio buttons for 'Source' (Any, Host, IP) and 'Destination' (Any, Host, IP). Each has a corresponding 'Wildcard' text box. Under 'IPv4 DSCP', there are radio buttons for 'IP Precedence' (selected) and 'DSCP (0-63)'. 'IP Precedence' has two dropdown menus for 'Please Select' and 'ToS Please Select'. 'DSCP' has a dropdown for 'Please Select' and a text box. At the bottom, 'Time Range' is '32 chars' and 'Action' has 'Permit' (selected) and 'Deny' radio buttons. 'Back' and 'Next' buttons are at the bottom right.

Figure 8-13 ACL Configuration Wizard (Add Rule for IPv4 ACL) OSPF window

The **dynamic** fields that can be configured are described below:

Parameter	Description
Fragments	Select the Fragments option to include packet fragment filtering.
Source	Select and enter the source information here. Options to choose from are Any , Host , and IP . When the Any option is selected, any source traffic will be evaluated according to the conditions of this rule. When the Host option is selected, enter the source host's IP address here. When the IP option is selected, the Wildcard option will also be available. Enter the group of source IP addresses by using a wildcard bitmap. The bit corresponding to the bit value 1 will be ignored. The bit corresponding to the bit value 0 will be checked.
Destination	Select and enter the destination information here. Options to choose from are Any , Host , and IP . When the Any option is selected, any destination traffic will be evaluated according to the conditions of this rule. When the Host option is selected, enter the destination host's IP address here. When the IP option is selected, the Wildcard option will also be available. Enter the group of destination IP addresses by using a wildcard bitmap. The bit corresponding to the bit value 1 will be ignored. The bit corresponding to the bit value 0 will be checked.
IP Precedence	Select the IP precedence value used here. Options to choose from are 0 (routine) , 1 (priority) , 2, (immediate) , 3 (flash) , 4 (flash-override) ,

	5 (critical), 6 (internet), and 7 (network).
ToS	After selecting the IP precedence value, select the Type-of-Service (ToS) value that will be used here. Options to choose from are 0 (normal), 1 (min-monetary-cost), 2 (max-reliability), 3, 4 (max-throughput), 5, 6, 7, 8 (min-delay), 9, 10, 11, 12, 13, 14, and 15.
DSCP	Select or enter the DSCP value used here. This value must be between 0 and 63 .
Time Range	Enter the name of the time range to associate with this ACL rule.
Action	Select the action that this rule will take here. Options to choose from are Permit and Deny .

After selecting the **PIM** option as the **Protocol Type**, the following section will appear.

The screenshot shows the 'ACL Configuration Wizard' interface. The current step is 'Add Rule'. The 'Protocol Type' is set to 'PIM' with a sequence number of '103'. Under 'Assign rule criteria', there are sections for 'IPv4 Address' and 'IPv4 DSCP'. The 'IPv4 Address' section has radio buttons for 'Any', 'Host', and 'IP', with a 'Wildcard' field. The 'IPv4 DSCP' section has radio buttons for 'IP Precedence' and 'DSCP (0-63)', with dropdown menus for 'IP Precedence' and 'ToS', and a text field for 'DSCP'. The 'Action' is set to 'Permit'. 'Back' and 'Next' buttons are at the bottom right.

Figure 8-14 ACL Configuration Wizard (Add Rule for IPv4 ACL) PIM window

The **dynamic** fields that can be configured are described below:

Parameter	Description
Fragments	Select the Fragments option to include packet fragment filtering.
Source	Select and enter the source information here. Options to choose from are Any , Host , and IP . When the Any option is selected, any source traffic will be evaluated according to the conditions of this rule. When the Host option is selected, enter the source host's IP address here. When the IP option is selected, the Wildcard option will also be available. Enter the group of source IP addresses by using a wildcard bitmap. The bit corresponding to the bit value 1 will be ignored. The bit corresponding to the bit value 0 will be checked.
Destination	Select and enter the destination information here. Options to choose from are Any , Host , and IP . When the Any option is selected, any destination traffic will be evaluated according to the conditions of this rule. When the Host option is selected, enter the destination host's IP

	address here. When the IP option is selected, the Wildcard option will also be available. Enter the group of destination IP addresses by using a wildcard bitmap. The bit corresponding to the bit value 1 will be ignored. The bit corresponding to the bit value 0 will be checked.
IP Precedence	Select the IP precedence value used here. Options to choose from are 0 (routine) , 1 (priority) , 2, (immediate) , 3 (flash) , 4 (flash-override) , 5 (critical) , 6 (internet) , and 7 (network) .
ToS	After selecting the IP precedence value, select the Type-of-Service (ToS) value that will be used here. Options to choose from are 0 (normal) , 1 (min-monetary-cost) , 2 (max-reliability) , 3, 4 (max-throughput) , 5, 6, 7, 8 (min-delay) , 9, 10, 11, 12, 13, 14 , and 15 .
DSCP	Select or enter the DSCP value used here. This value must be between 0 and 63.
Time Range	Enter the name of the time range to associate with this ACL rule.
Action	Select the action that this rule will take here. Options to choose from are Permit and Deny .

After selecting the **VRRP** option as the **Protocol Type**, the following section will appear.

The screenshot shows the 'ACL Configuration Wizard' window. The title bar reads 'ACL Configuration Wizard'. Below the title bar, the breadcrumb path is 'Access-List Assignment >> Select Packet Type >> Add Rule >> Apply Port'. The main content area is titled 'Please assign a sequence number to create a new rule.' and contains the following fields and options:

- Sequence No. (1-65535):** A text input field with a value of 112. There is an 'Auto Assign' radio button next to it.
- Protocol Type:** A dropdown menu set to 'VRRP'.
- 112 (0-255):** A text input field for the sequence number.
- Fragments:** A checkbox that is currently unchecked.
- Assign rule criteria:** A section with two tabs: 'IPv4 Address' and 'IPv4 DSCP'.
 - IPv4 Address:** Contains 'Source' and 'Destination' sections. Each has radio buttons for 'Any', 'Host', and 'IP'. Below 'IP' is a 'Wildcard' text input field.
 - IPv4 DSCP:** Contains 'IP Precedence' and 'ToS' dropdown menus (both set to 'Please Select'), a 'DSCP (0-63)' dropdown menu (set to 'Please Select'), and a text input field.
 - Time Range:** A text input field with the value '32 chars'.
 - Action:** Radio buttons for 'Permit' (selected) and 'Deny'.

At the bottom right, there are 'Back' and 'Next' buttons.

Figure 8-15 ACL Configuration Wizard (Add Rule for IPv4 ACL) VRRP window

The **dynamic** fields that can be configured are described below:

Parameter	Description
Fragments	Select the Fragments option to include packet fragment filtering.
Source	Select and enter the source information here. Options to choose from are Any , Host , and IP . When the Any option is selected, any source traffic will be evaluated according to the conditions of this rule. When the Host option is selected, enter the source host's IP address here. When the IP option is selected, the Wildcard option will also be available. Enter the group of source IP addresses by using a wildcard

	bitmap. The bit corresponding to the bit value 1 will be ignored. The bit corresponding to the bit value 0 will be checked.
Destination	Select and enter the destination information here. Options to choose from are Any , Host , and IP . When the Any option is selected, any destination traffic will be evaluated according to the conditions of this rule. When the Host option is selected, enter the destination host's IP address here. When the IP option is selected, the Wildcard option will also be available. Enter the group of destination IP addresses by using a wildcard bitmap. The bit corresponding to the bit value 1 will be ignored. The bit corresponding to the bit value 0 will be checked.
IP Precedence	Select the IP precedence value used here. Options to choose from are 0 (routine) , 1 (priority) , 2 (immediate) , 3 (flash) , 4 (flash-override) , 5 (critical) , 6 (internet) , and 7 (network) .
ToS	After selecting the IP precedence value, select the Type-of-Service (ToS) value that will be used here. Options to choose from are 0 (normal) , 1 (min-monetary-cost) , 2 (max-reliability) , 3, 4 (max-throughput) , 5, 6, 7, 8 (min-delay) , 9, 10, 11, 12, 13, 14, and 15 .
DSCP	Select or enter the DSCP value used here. This value must be between 0 and 63.
Time Range	Enter the name of the time range to associate with this ACL rule.
Action	Select the action that this rule will take here. Options to choose from are Permit and Deny .

After selecting the **IP-in-IP** option as the **Protocol Type**, the following section will appear.

The screenshot shows the 'ACL Configuration Wizard' interface. The breadcrumb path is 'Access-List Assignment >> Select Packet Type >> Add Rule >> Apply Port'. The main instruction is 'Please assign a sequence number to create a new rule.' There are two radio buttons: 'Sequence No. (1-65535)' (selected) and 'Auto Assign'. Below this, the 'Protocol Type' is set to 'IP-in-IP' with a value of '94' (range 0-255) and a 'Fragments' checkbox. The 'Assign rule criteria' section has two tabs: 'IPv4 Address' and 'IPv4 DSCP'. Under 'IPv4 Address', there are 'Source' and 'Destination' sections, each with radio buttons for 'Any', 'Host', and 'IP', and a 'Wildcard' input field. Under 'IPv4 DSCP', there are radio buttons for 'IP Precedence' (selected) and 'DSCP (0-63)', each with a 'Please Select' dropdown menu. There is also a 'ToS' dropdown menu. At the bottom, there is a 'Time Range' input field with '32 chars' and an 'Action' section with 'Permit' (selected) and 'Deny' radio buttons. 'Back' and 'Next' buttons are at the bottom right.

Figure 8-16 ACL Configuration Wizard (Add Rule for IPv4 ACL) IP-in-IP window

The **dynamic** fields that can be configured are described below:

Parameter	Description
Fragments	Select the Fragments option to include packet fragment filtering.
Source	Select and enter the source information here. Options to choose from are Any , Host , and IP . When the Any option is selected, any source traffic will be evaluated according to the conditions of this rule. When the Host option is selected, enter the source host's IP address here. When the IP option is selected, the Wildcard option will also be available. Enter the group of source IP addresses by using a wildcard bitmap. The bit corresponding to the bit value 1 will be ignored. The bit corresponding to the bit value 0 will be checked.
Destination	Select and enter the destination information here. Options to choose from are Any , Host , and IP . When the Any option is selected, any destination traffic will be evaluated according to the conditions of this rule. When the Host option is selected, enter the destination host's IP address here. When the IP option is selected, the Wildcard option will also be available. Enter the group of destination IP addresses by using a wildcard bitmap. The bit corresponding to the bit value 1 will be ignored. The bit corresponding to the bit value 0 will be checked.
IP Precedence	Select the IP precedence value used here. Options to choose from are 0 (routine) , 1 (priority) , 2 (immediate) , 3 (flash) , 4 (flash-override) , 5 (critical) , 6 (internet) , and 7 (network) .
ToS	After selecting the IP precedence value, select the Type-of-Service (ToS) value that will be used here. Options to choose from are 0 (normal) , 1 (min-monetary-cost) , 2 (max-reliability) , 3, 4 (max-throughput) , 5, 6, 7, 8 (min-delay) , 9, 10, 11, 12, 13, 14 , and 15 .
DSCP	Select or enter the DSCP value used here. This value must be between 0 and 63.
Time Range	Enter the name of the time range to associate with this ACL rule.
Action	Select the action that this rule will take here. Options to choose from are Permit and Deny .

After selecting the **PCP** option as the **Protocol Type**, the following section will appear.

Figure 8-17 ACL Configuration Wizard (Add Rule for IPv4 ACL) PCP window

The **dynamic** fields that can be configured are described below:

Parameter	Description
Fragments	Select the Fragments option to include packet fragment filtering.
Source	Select and enter the source information here. Options to choose from are Any , Host , and IP . When the Any option is selected, any source traffic will be evaluated according to the conditions of this rule. When the Host option is selected, enter the source host's IP address here. When the IP option is selected, the Wildcard option will also be available. Enter the group of source IP addresses by using a wildcard bitmap. The bit corresponding to the bit value 1 will be ignored. The bit corresponding to the bit value 0 will be checked.
Destination	Select and enter the destination information here. Options to choose from are Any , Host , and IP . When the Any option is selected, any destination traffic will be evaluated according to the conditions of this rule. When the Host option is selected, enter the destination host's IP address here. When the IP option is selected, the Wildcard option will also be available. Enter the group of destination IP addresses by using a wildcard bitmap. The bit corresponding to the bit value 1 will be ignored. The bit corresponding to the bit value 0 will be checked.
IP Precedence	Select the IP precedence value used here. Options to choose from are 0 (routine) , 1 (priority) , 2 (immediate) , 3 (flash) , 4 (flash-override) , 5 (critical) , 6 (internet) , and 7 (network) .
ToS	After selecting the IP precedence value, select the Type-of-Service (ToS) value that will be used here. Options to choose from are 0 (normal) , 1 (min-monetary-cost) , 2 (max-reliability) , 3, 4 (max-throughput) , 5, 6, 7, 8 (min-delay) , 9, 10, 11, 12, 13, 14 , and 15 .
DSCP	Select or enter the DSCP value used here. This value must be

	between 0 and 63.
Time Range	Enter the name of the time range to associate with this ACL rule.
Action	Select the action that this rule will take here. Options to choose from are Permit and Deny .

After selecting the **Protocol ID** option as the **Protocol Type**, the following section will appear.

The screenshot shows the 'ACL Configuration Wizard' interface. At the top, it says 'Access-List Assignment >> Select Packet Type >> Add Rule >> Apply Port'. Below this, it prompts the user to 'Please assign a sequence number to create a new rule.' There are two radio buttons: 'Sequence No. (1-65535)' (selected) and 'Auto Assign'. A text input field is next to the first option. Below that, 'Protocol Type' is set to 'Protocol ID' in a dropdown menu, with a text input field for the value (0-255) and a 'Fragments' checkbox. The 'Assign rule criteria' section has two tabs: 'IPv4 Address' and 'IPv4 DSCP'. Under 'IPv4 Address', there are radio buttons for 'Any', 'Host', and 'IP'. The 'Any' option is selected. There are also radio buttons for 'Source' and 'Destination', both with 'Any' selected. Text input fields for 'Host' and 'Wildcard' are present for both source and destination. Under 'IPv4 DSCP', there are radio buttons for 'IP Precedence' (selected) and 'DSCP (0-63)'. 'IP Precedence' has two dropdown menus for 'Please Select' and 'ToS Please Select'. 'DSCP (0-63)' has a dropdown menu for 'Please Select' and a text input field. At the bottom, there is a 'Time Range' text input field with '32 chars' and an 'Action' section with 'Permit' (selected) and 'Deny' radio buttons. 'Back' and 'Next' buttons are at the bottom right.

Figure 8-18 ACL Configuration Wizard (Add Rule for IPv4 ACL) Protocol ID window

The **dynamic** fields that can be configured are described below:

Parameter	Description
Protocol	Enter the Protocol ID value in the space provided. This value must be between 0 and 255 .
Fragments	Select the Fragments option to include packet fragment filtering.
Source	Select and enter the source information here. Options to choose from are Any , Host , and IP . When the Any option is selected, any source traffic will be evaluated according to the conditions of this rule. When the Host option is selected, enter the source host's IP address here. When the IP option is selected, the Wildcard option will also be available. Enter the group of source IP addresses by using a wildcard bitmap. The bit corresponding to the bit value 1 will be ignored. The bit corresponding to the bit value 0 will be checked.
Destination	Select and enter the destination information here. Options to choose from are Any , Host , and IP . When the Any option is selected, any destination traffic will be evaluated according to the conditions of this rule. When the Host option is selected, enter the destination host's IP address here. When the IP option is selected, the Wildcard option will also be available. Enter the group of destination IP addresses by using a wildcard bitmap. The bit corresponding to the bit value 1 will be ignored. The bit corresponding to the bit value 0 will be checked.

IP Precedence	Select the IP precedence value used here. Options to choose from are 0 (routine) , 1 (priority) , 2, (immediate) , 3 (flash) , 4 (flash-override) , 5 (critical) , 6 (internet) , and 7 (network) .
ToS	After selecting the IP precedence value, select the Type-of-Service (ToS) value that will be used here. Options to choose from are 0 (normal) , 1 (min-monetary-cost) , 2 (max-reliability) , 3, 4 (max-throughput) , 5, 6, 7, 8 (min-delay) , 9, 10, 11, 12, 13, 14 , and 15 .
DSCP	Select or enter the DSCP value used here. This value must be between 0 and 63.
Time Range	Enter the name of the time range to associate with this ACL rule.
Action	Select the action that this rule will take here. Options to choose from are Permit and Deny .

After selecting the **None** option as the **Protocol Type**, the following section will appear.

The screenshot shows the 'ACL Configuration Wizard' window. At the top, it says 'Access-List Assignment >> Select Packet Type >> Add Rule >> Apply Port'. Below that, it asks to 'Please assign a sequence number to create a new rule.' with radio buttons for 'Sequence No. (1-65535)' (selected) and 'Auto Assign'. The 'Protocol Type' is set to 'None'. There are two tabs: 'IPv4 Address' and 'IPv4 DSCP'. Under 'IPv4 Address', there are sections for 'Source' and 'Destination', each with radio buttons for 'Any', 'Host', and 'IP', and a 'Wildcard' field. Under 'IPv4 DSCP', there are radio buttons for 'IP Precedence' (selected) and 'DSCP (0-63)'. The 'IP Precedence' section has dropdowns for 'Please Select' and 'ToS Please Select'. The 'DSCP' section has a dropdown for 'Please Select' and a text input field. There is a 'Time Range' field with '32 chars' and an 'Action' section with radio buttons for 'Permit' (selected) and 'Deny'. 'Back' and 'Next' buttons are at the bottom right.

Figure 8-19 ACL Configuration Wizard (Add Rule for IPv4 ACL) None window

The **dynamic** fields that can be configured are described below:

Parameter	Description
Fragments	Select the Fragments option to include packet fragment filtering.
Source	Select and enter the source information here. Options to choose from are Any , Host , and IP . When the Any option is selected, any source traffic will be evaluated according to the conditions of this rule. When the Host option is selected, enter the source host's IP address here. When the IP option is selected, the Wildcard option will also be available. Enter the group of source IP addresses by using a wildcard bitmap. The bit corresponding to the bit value 1 will be ignored. The bit corresponding to the bit value 0 will be checked.
Destination	Select and enter the destination information here. Options to choose

	from are Any , Host , and IP . When the Any option is selected, any destination traffic will be evaluated according to the conditions of this rule. When the Host option is selected, enter the destination host's IP address here. When the IP option is selected, the Wildcard option will also be available. Enter the group of destination IP addresses by using a wildcard bitmap. The bit corresponding to the bit value 1 will be ignored. The bit corresponding to the bit value 0 will be checked.
IP Precedence	Select the IP precedence value used here. Options to choose from are 0 (routine) , 1 (priority) , 2, (immediate) , 3 (flash) , 4 (flash-override) , 5 (critical) , 6 (internet) , and 7 (network) .
ToS	After selecting the IP precedence value, select the Type-of-Service (ToS) value that will be used here. Options to choose from are 0 (normal) , 1 (min-monetary-cost) , 2 (max-reliability) , 3, 4 (max-throughput) , 5, 6, 7, 8 (min-delay) , 9, 10, 11, 12, 13, 14 , and 15 .
DSCP	Select or enter the DSCP value used here. This value must be between 0 and 63.
Time Range	Enter the name of the time range to associate with this ACL rule.
Action	Select the action that this rule will take here. Options to choose from are Permit and Deny .

Click the **Back** button to return to the previous window.

Click the **Next** button to continue.

After clicking the **IPv6** radio button and the **Next** button, the following window will appear.

Figure 8-20 ACL Configuration Wizard (Add Rule for IPv6 ACL) window

This window has a dynamic section. Every selection made in the **Protocol Type** drop-down list will change the bottom part of this window.

The **fixed** fields that can be configured are described below:

Parameter	Description
Sequence No.	Enter the ACL rule number here. This value must be between 1 and 65535. Select Auto Assign to automatically generate an ACL rule number for this entry.
Protocol Type	Select the protocol type option here. Options to choose from are TCP ,

UDP, ICMP, Protocol ID, ESP, PCP, SCTP, and None.

After selecting the **TCP** option as the **Protocol Type**, the following section will appear.

The screenshot shows the 'ACL Configuration Wizard' interface. At the top, it indicates the current step: 'Access-List Assignment >> Select Packet Type >> Add Rule >> Apply Port'. Below this, it prompts the user to 'Please assign a sequence number to create a new rule.' There are two options: 'Sequence No. (1-85535)' with an input field and 'Auto Assign'. The 'Protocol Type' is set to 'TCP' in a dropdown menu, with an adjacent input field for a value (0-255) and a 'Fragments' checkbox. The 'Assign rule criteria' section contains several sub-sections: 'IPv6 Address' with 'Any', 'Host', and 'IPv6' radio buttons and corresponding input fields for address and prefix length; 'Port' with 'Source Port' and 'Destination Port' dropdowns and input fields; 'IPv6 DSCP' with a 'DSCP (0-63)' dropdown and input field; 'TCP Flag' with checkboxes for 'ack', 'fin', 'psh', 'rst', 'syn', and 'urg'; 'Flow Label' with a 'Flow Label (0-1048575)' input field; and 'Time Range' with a 'Time Range' input field showing '32 chars'. At the bottom, the 'Action' is set to 'Permit' with radio buttons for 'Permit' and 'Deny'. 'Back' and 'Next' buttons are located at the bottom right.

Figure 8-21 ACL Configuration Wizard (Add Rule for IPv6 ACL) TCP window

The **dynamic** fields that can be configured are described below:

Parameter	Description
Source	Select and enter the source information here. Options to choose from are Any , Host , and IPv6 . When the Any option is selected, any source traffic will be evaluated according to the conditions of this rule. When the Host option is selected, enter the source host's IPv6 address here. When the IPv6 option is selected, the Prefix Length option will also be available. Enter the source IPv6 address and prefix length value in the spaces provided.
Destination	Select and enter the destination information here. Options to choose from are Any , Host , and IPv6 . When the Any option is selected, any destination traffic will be evaluated according to the conditions of this rule. When the Host option is selected, enter the destination host's IPv6 address here. When the IPv6 option is selected, the Prefix Length option will also be available. Enter the destination IPv6 address and prefix length value in the spaces provided.
Source Port	Select and enter the source port value here. Options to choose from are = , > , < , ≠ , and Range . When selecting the = option, the specific selected port number will be used. When selecting the > option, all ports greater than the selected port, will be used. When selecting the < option, all ports smaller than the selected port, will be used. When

	selecting the ≠ option, all ports, excluding the selected port, will be used. When selecting the Range option, the start port number and end port number selected, of the range, will be used. Alternatively, the port number(s) can manually be entered in the space(s) provided, if the port number(s) is/are not available in the drop-down list.
Destination Port	Select and enter the destination port value here. Options to choose from are = , > , < , ≠ , and Range . When selecting the = option, the specific selected port number will be used. When selecting the > option, all ports greater than the selected port, will be used. When selecting the < option, all ports smaller than the selected port, will be used. When selecting the ≠ option, all ports, excluding the selected port, will be used. When selecting the Range option, the start port number and end port number selected, of the range, will be used. Alternatively, the port number(s) can manually be entered in the space(s) provided, if the port number(s) is/are not available in the drop-down list.
DSCP	Select or enter the DSCP value used here. This value must be between 0 and 63.
TCP Flag	Tick the appropriate TCP flag option to include the flag in this rule. Options to choose from are ack , fin , psh , rst , syn , and urg .
Flow Label	Enter the flow label value here. This value must be between 0 and 1048575.
Time Range	Enter the name of the time range to associate with this ACL rule.
Action	Select the action that this rule will take here. Options to choose from are Permit and Deny .

After selecting the **UDP** option as the **Protocol Type**, the following section will appear.

ACL Configuration Wizard

Access-List Assignment >> Select Packet Type >> Add Rule >> Apply Port

Please assign a sequence number to create a new rule.

Sequence No. (1-65535) Auto Assign

Protocol Type **UDP** (0-255) Fragments

Assign rule criteria

IPv6 Address **Port** **IPv6 DSCP** **Flow Label**

IPv6 Address

Any Host IPv6

Source 2012::1 2012::1 Prefix Length

Destination Any Host IPv6

2012::1 2012::1 Prefix Length

Port

Source Port **Please Select** (0-65535) (0-65535)

Destination Port **Please Select** (0-65535) (0-65535)

IPv6 DSCP

DSCP (0-63) **Please Select**

Flow Label

Flow Label (0-1048575)

Time Range 32 chars

Action Permit Deny

Figure 8-22 ACL Configuration Wizard (Add Rule for IPv6 ACL) UDP window

The **dynamic** fields that can be configured are described below:

Parameter	Description
Source	Select and enter the source information here. Options to choose from are Any , Host , and IPv6 . When the Any option is selected, any source traffic will be evaluated according to the conditions of this rule. When the Host option is selected, enter the source host's IPv6 address here. When the IPv6 option is selected, the Prefix Length option will also be available. Enter the source IPv6 address and prefix length value in the spaces provided.
Destination	Select and enter the destination information here. Options to choose from are Any , Host , and IPv6 . When the Any option is selected, any destination traffic will be evaluated according to the conditions of this rule. When the Host option is selected, enter the destination host's IPv6 address here. When the IPv6 option is selected, the Prefix Length option will also be available. Enter the destination IPv6 address and prefix length value in the spaces provided.
Source Port	Select and enter the source port value here. Options to choose from are = , > , < , ≠ , and Range . When selecting the = option, the specific selected port number will be used. When selecting the > option, all ports greater than the selected port, will be used. When selecting the < option, all ports smaller than the selected port, will be used. When selecting the ≠ option, all ports, excluding the selected port, will be used. When selecting the Range option, the start port number and end port number selected, of the range, will be used. Alternatively, the port

	number(s) can manually be entered in the space(s) provided, if the port number(s) is/are not available in the drop-down list.
Destination Port	Select and enter the destination port value here. Options to choose from are =, >, <, ≠, and Range . When selecting the = option, the specific selected port number will be used. When selecting the > option, all ports greater than the selected port, will be used. When selecting the < option, all ports smaller than the selected port, will be used. When selecting the ≠ option, all ports, excluding the selected port, will be used. When selecting the Range option, the start port number and end port number selected, of the range, will be used. Alternatively, the port number(s) can manually be entered in the space(s) provided, if the port number(s) is/are not available in the drop-down list.
DSCP	Select or enter the DSCP value used here. This value must be between 0 and 63.
Flow Label	Enter the flow label value here. This value must be between 0 and 1048575.
Time Range	Enter the name of the time range to associate with this ACL rule.
Action	Select the action that this rule will take here. Options to choose from are Permit and Deny .

After selecting the **ICMP** option as the **Protocol Type**, the following section will appear.

ACL Configuration Wizard

ACL Configuration Wizard

Access-List Assignment >> Select Packet Type >> [Add Rule](#) >> Apply Port

Please assign a sequence number to create a new rule.

Sequence No. (1-65535) Auto Assign

Protocol Type (0-255) Fragments

Assign rule criteria

IPv6 Address

Any Host IPv6 Prefix Length

Destination

Any Host IPv6 Prefix Length

ICMP

Specify ICMP Message Type

ICMP Message Type (0-255) Message Code (0-255)

IPv6 DSCP

DSCP (0-63)

Flow Label

Flow Label (0-1048575)

Time Range

Action Permit Deny

Figure 8-23 ACL Configuration Wizard (Add Rule for IPv6 ACL) ICMP window

The **dynamic** fields that can be configured are described below:

Parameter	Description
Source	Select and enter the source information here. Options to choose from are Any , Host , and IPv6 . When the Any option is selected, any source traffic will be evaluated according to the conditions of this rule. When the Host option is selected, enter the source host's IPv6 address here. When the IPv6 option is selected, the Prefix Length option will also be available. Enter the source IPv6 address and prefix length value in the spaces provided.
Destination	Select and enter the destination information here. Options to choose from are Any , Host , and IPv6 . When the Any option is selected, any destination traffic will be evaluated according to the conditions of this rule. When the Host option is selected, enter the destination host's IPv6 address here. When the IPv6 option is selected, the Prefix Length option will also be available. Enter the destination IPv6 address and prefix length value in the spaces provided.
Specify ICMP Message Type	Select the ICMP message type used here.
ICMP Message Type	When the ICMP Message Type is not selected, enter the ICMP Message Type numerical value used here. When the ICMP Message Type is selected, this numerical value will automatically be entered.
Message Code	When the ICMP Message Type is not selected, enter the Message Code numerical value used here. When the ICMP Message Type is selected, this numerical value will automatically be entered.
DSCP	Select or enter the DSCP value used here. This value must be between 0 and 63.
Flow Label	Enter the flow label value here. This value must be between 0 and 1048575.
Time Range	Enter the name of the time range to associate with this ACL rule.
Action	Select the action that this rule will take here. Options to choose from are Permit and Deny .

After selecting the **Protocol ID** option as the **Protocol Type**, the following section will appear.

The screenshot shows the 'ACL Configuration Wizard' window. At the top, it says 'Access-List Assignment >> Select Packet Type >> Add Rule >> Apply Port'. Below that, it asks to 'Please assign a sequence number to create a new rule.' with radio buttons for 'Sequence No. (1-65535)' (selected) and 'Auto Assign'. There is a text input field for the sequence number. Below that, it says 'Protocol Type' with a dropdown menu set to 'Protocol ID' and a text input field for the Protocol ID (0-255). There is also a checkbox for 'Fragments'. The main section is 'Assign rule criteria' with three tabs: 'IPv6 Address', 'IPv6 DSCP', and 'Flow Label'. Under 'IPv6 Address', there are radio buttons for 'Any' (selected), 'Host', and 'IPv6'. For 'Host' and 'IPv6', there are input fields for IPv6 addresses and 'Prefix Length'. There are also radio buttons for 'Destination' with 'Any' (selected), 'Host', and 'IPv6' options. Under 'IPv6 DSCP', there is a dropdown menu 'DSCP (0-63) Please Select' and an input field. Under 'Flow Label', there is an input field 'Flow Label (0-1048575)'. Under 'Time Range', there is an input field '32 chars'. At the bottom, there are radio buttons for 'Action' with 'Permit' (selected) and 'Deny'. 'Back' and 'Next' buttons are at the bottom right.

Figure 8-24 ACL Configuration Wizard (Add Rule for IPv6 ACL) Protocol ID window

The **dynamic** fields that can be configured are described below:

Parameter	Description
Protocol	Enter the Protocol ID value used here. This value must be between 0 and 255.
Fragments	Select the Fragments option to include packet fragment filtering.
Source	Select and enter the source information here. Options to choose from are Any , Host , and IPv6 . When the Any option is selected, any source traffic will be evaluated according to the conditions of this rule. When the Host option is selected, enter the source host's IPv6 address here. When the IPv6 option is selected, the Prefix Length option will also be available. Enter the source IPv6 address and prefix length value in the spaces provided.
Destination	Select and enter the destination information here. Options to choose from are Any , Host , and IPv6 . When the Any option is selected, any destination traffic will be evaluated according to the conditions of this rule. When the Host option is selected, enter the destination host's IPv6 address here. When the IPv6 option is selected, the Prefix Length option will also be available. Enter the destination IPv6 address and prefix length value in the spaces provided.
DSCP	Select or enter the DSCP value used here. This value must be between 0 and 63 .
Flow Label	Enter the flow label value here. This value must be between 0 and 1048575.
Time Range	Enter the name of the time range to associate with this ACL rule.
Action	Select the action that this rule will take here. Options to choose from

are **Permit** and **Deny**.

After selecting the **ESP** option as the **Protocol Type**, the following section will appear.

The screenshot shows the 'ACL Configuration Wizard' window. At the top, it says 'Access-List Assignment >> Select Packet Type >> Add Rule >> Apply Port'. Below that, it asks to 'Please assign a sequence number to create a new rule.' with radio buttons for 'Sequence No. (1-65535)' (selected) and 'Auto Assign'. The 'Protocol Type' is set to 'ESP' with a value of '50' (0-255) and a 'Fragments' checkbox. The 'Assign rule criteria' section has three tabs: 'IPv6 Address', 'IPv6 DSCP', and 'Flow Label'. Under 'IPv6 Address', there are 'Source' and 'Destination' sections. Each has radio buttons for 'Any', 'Host', and 'IPv6'. The 'Any' option is selected for both. Input fields for IPv6 addresses and 'Prefix Length' are provided. Below this, there are fields for 'IPv6 DSCP' (DSCP 0-63), 'Flow Label' (Flow Label 0-1048575), and 'Time Range' (32 chars). At the bottom, the 'Action' is set to 'Permit' (radio button selected) and 'Deny'. 'Back' and 'Next' buttons are at the bottom right.

Figure 8-25 ACL Configuration Wizard (Add Rule for IPv6 ACL) ESP window

The **dynamic** fields that can be configured are described below:

Parameter	Description
Fragments	Select the Fragments option to include packet fragment filtering.
Source	Select and enter the source information here. Options to choose from are Any , Host , and IPv6 . When the Any option is selected, any source traffic will be evaluated according to the conditions of this rule. When the Host option is selected, enter the source host's IPv6 address here. When the IPv6 option is selected, the Prefix Length option will also be available. Enter the source IPv6 address and prefix length value in the spaces provided.
Destination	Select and enter the destination information here. Options to choose from are Any , Host , and IPv6 . When the Any option is selected, any destination traffic will be evaluated according to the conditions of this rule. When the Host option is selected, enter the destination host's IPv6 address here. When the IPv6 option is selected, the Prefix Length option will also be available. Enter the destination IPv6 address and prefix length value in the spaces provided.
DSCP	Select or enter the DSCP value used here. This value must be between 0 and 63.
Flow Label	Enter the flow label value here. This value must be between 0 and 1048575.
Time Range	Enter the name of the time range to associate with this ACL rule.

Action	Select the action that this rule will take here. Options to choose from are Permit and Deny .
---------------	---

After selecting the **PCP** option as the **Protocol Type**, the following section will appear.

The screenshot shows the 'ACL Configuration Wizard' interface. At the top, it indicates the current step: 'Access-List Assignment >> Select Packet Type >> Add Rule >> Apply Port'. Below this, it prompts the user to 'Please assign a sequence number to create a new rule.' There are two options: 'Sequence No. (1-65535)' with an input field and 'Auto Assign'. The 'Protocol Type' is set to 'PCP' with a value of '108' (range 0-255). A 'Fragments' checkbox is present. Under 'Assign rule criteria', three tabs are visible: 'IPv6 Address', 'IPv6 DSCP', and 'Flow Label'. The 'IPv6 Address' section has 'Any' selected for both Source and Destination, with input fields for Host and IPv6 addresses (all containing '2012::1') and Prefix Length. The 'IPv6 DSCP' section has a dropdown menu set to 'Please Select' and an empty input field. The 'Flow Label' section has an empty input field. A 'Time Range' field contains '32 chars'. At the bottom, the 'Action' is set to 'Permit'. 'Back' and 'Next' buttons are at the bottom right.

Figure 8-26 ACL Configuration Wizard (Add Rule for IPv6 ACL) PCP window

The **dynamic** fields that can be configured are described below:

Parameter	Description
Fragments	Select the Fragments option to include packet fragment filtering.
Source	Select and enter the source information here. Options to choose from are Any , Host , and IPv6 . When the Any option is selected, any source traffic will be evaluated according to the conditions of this rule. When the Host option is selected, enter the source host's IPv6 address here. When the IPv6 option is selected, the Prefix Length option will also be available. Enter the source IPv6 address and prefix length value in the spaces provided.
Destination	Select and enter the destination information here. Options to choose from are Any , Host , and IPv6 . When the Any option is selected, any destination traffic will be evaluated according to the conditions of this rule. When the Host option is selected, enter the destination host's IPv6 address here. When the IPv6 option is selected, the Prefix Length option will also be available. Enter the destination IPv6 address and prefix length value in the spaces provided.
DSCP	Select or enter the DSCP value used here. This value must be between 0 and 63.
Flow Label	Enter the flow label value here. This value must be between 0 and 1048575.

Time Range	Enter the name of the time range to associate with this ACL rule.
Action	Select the action that this rule will take here. Options to choose from are Permit and Deny .

After selecting the **SCTP** option as the **Protocol Type**, the following section will appear.

ACL Configuration Wizard

Access-List Assignment >> Select Packet Type >> Add Rule >> Apply Port

Please assign a sequence number to create a new rule.

Sequence No. (1-65535) Auto Assign

Protocol Type: SCTP (0-255) Fragments

Assign rule criteria

IPv6 Address

Any Host IPv6

Source: Any Host IPv6

Destination: Any Host IPv6

IPv6 DSCP

DSCP (0-63) Please Select

Flow Label

Flow Label (0-1048575)

Time Range

Action Permit Deny

Figure 8-27 ACL Configuration Wizard (Add Rule for IPv6 ACL) SCTP window

The **dynamic** fields that can be configured are described below:

Parameter	Description
Fragments	Select the Fragments option to include packet fragment filtering.
Source	Select and enter the source information here. Options to choose from are Any , Host , and IPv6 . When the Any option is selected, any source traffic will be evaluated according to the conditions of this rule. When the Host option is selected, enter the source host's IPv6 address here. When the IPv6 option is selected, the Prefix Length option will also be available. Enter the source IPv6 address and prefix length value in the spaces provided.
Destination	Select and enter the destination information here. Options to choose from are Any , Host , and IPv6 . When the Any option is selected, any destination traffic will be evaluated according to the conditions of this rule. When the Host option is selected, enter the destination host's IPv6 address here. When the IPv6 option is selected, the Prefix Length option will also be available. Enter the destination IPv6 address and prefix length value in the spaces provided.
DSCP	Select or enter the DSCP value used here. This value must be between 0 and 63.
Flow Label	Enter the flow label value here. This value must be between 0 and

	1048575.
Time Range	Enter the name of the time range to associate with this ACL rule.
Action	Select the action that this rule will take here. Options to choose from are Permit and Deny .

After selecting the **None** option as the **Protocol Type**, the following section will appear.

Figure 8-28 ACL Configuration Wizard (Add Rule for IPv6 ACL) None window

The **dynamic** fields that can be configured are described below:

Parameter	Description
Fragments	Select the Fragments option to include packet fragment filtering.
Source	Select and enter the source information here. Options to choose from are Any , Host , and IPv6 . When the Any option is selected, any source traffic will be evaluated according to the conditions of this rule. When the Host option is selected, enter the source host's IPv6 address here. When the IPv6 option is selected, the Prefix Length option will also be available. Enter the source IPv6 address and prefix length value in the spaces provided.
Destination	Select and enter the destination information here. Options to choose from are Any , Host , and IPv6 . When the Any option is selected, any destination traffic will be evaluated according to the conditions of this rule. When the Host option is selected, enter the destination host's IPv6 address here. When the IPv6 option is selected, the Prefix Length option will also be available. Enter the destination IPv6 address and prefix length value in the spaces provided.
DSCP	Select or enter the DSCP value used here. This value must be between 0 and 63.

Flow Label	Enter the flow label value here. This value must be between 0 and 1048575.
Time Range	Enter the name of the time range to associate with this ACL rule.
Action	Select the action that this rule will take here. Options to choose from are Permit and Deny .

Click the **Back** button to return to the previous window.

Click the **Next** button to continue.

After clicking the **Next** button, the following window will appear.

Figure 8-29 ACL Configuration Wizard (Apply Port) window

The fields that can be configured are described below:

Parameter	Description
Unit	Select the switch unit that will be used for this configuration here.
From Port / To Port	Select the appropriate port range used for the configuration here.
Direction	Select the direction here. Option to choose from is In .

Click the **Back** button to return to the previous window.

Click the **Apply** button to accept the changes made.

ACL Access List

This window is used to view and configure the ACL access list settings.

To view the following window, click **ACL > ACL Access List**, as shown below:

Figure 8-30 ACL Access List window

The fields that can be configured are described below:

Parameter	Description
ACL Type	Select the ACL profile type to find here. Options to choose from are All , IP ACL , IPv6 ACL , MAC ACL , and Expert ACL .
ID	Enter the ACL ID here. The range is from 1 to 14999.
ACL Name	Enter the ACL name here. This name can be up to 32 characters long.

Click the **Find** button to locate a specific entry based on the information entered.

Click the **Add ACL** button to create a new ACL profile.

Click the **Clear All Counter** button to clear all the counter information displayed.

Click the **Clear Counter** button to clear the counter information for the rule displayed.

Click the **Add Rule** button to create an ACL rule for the ACL profile selected.

Standard IP ACL

After clicking the **Add ACL** button, users can create a new ACL profile, as shown below:

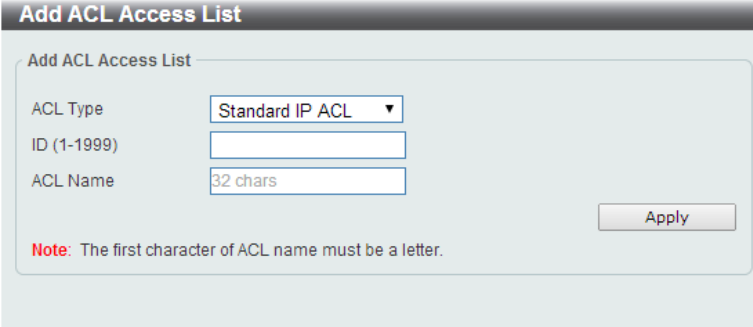

Figure 8-31 Standard IP ACL (Add ACL Access List) window

The fields that can be configured are described below:

Parameter	Description
ACL Type	Select the ACL profile type here. Options to choose from are Standard IP ACL , Extended IP ACL , Standard IPv6 ACL , Extended IPv6 ACL , Extended MAC ACL , and Extended Expert ACL .
ID	Enter the ACL ID from 1 to 1999.
ACL Name	Enter the ACL profile's name here. This name can be up to 32 characters long.

Click the **Apply** button to create the new ACL profile.

After creating a Standard IP ACL profile, the newly created Standard IP ACL profile will be displayed in the ACL profile display table, as shown below:

ACL Access List

ACL Type: All | ID (1-14999) | ACL Name: 32 chars | Find

Total Entries: 1 | Add ACL

ID	ACL Name	ACL Type	Start Sequence No.	Step	Counter State	Remark	
1	StandardIP	Standard IP ACL	10	10	Disabled		Edit Delete

1/1 | < << 1 >> > | Go

Clear All Counter | Clear Counter | Add Rule

Sequence No.	Action	Rule	Time Range	Counter

Figure 8-32 Standard IP ACL (Main) window

Click the **Edit** button to re-configure the specific ACL profile.

Click the **Delete** button to remove the specific ACL profile.

Enter a page number and click the **Go** button to navigate to a specific page when multiple pages exist.

To add an ACL rule in the ACL profile, select it (the ACL profile will toggle to the bold font), and click the **Add Rule** button.

ACL Access List

ACL Type: All | ID (1-14999) | ACL Name: 32 chars | Find

Total Entries: 1 | Add ACL

ID	ACL Name	ACL Type	Start Sequence No.	Step	Counter State	Remark	
1	StandardIP	Standard IP ACL	10	10	Disabled		Edit Delete

1/1 | < << 1 >> > | Go

StandardIP (ID: 1) Rule | Clear All Counter | Clear Counter | Add Rule

Sequence No.	Action	Rule	Time Range	Counter

Figure 8-33 Standard IP ACL (Selected) window

After selecting the ACL profile and clicking the **Add Rule** button, users can configure the new ACL rule, in the selected ACL profile, as shown below:

Add ACL Rule

Add ACL Rule

ID: 1

ACL Name: StandardIP

ACL Type: Standard IP ACL

Sequence No. (1-65535): (If it isn't specified, the system automatically assigns.)

Action: Permit Deny

Match IP Address:

Source: Any Host IP Wildcard

Destination: Any Host IP Wildcard

Time Range: 32 chars

Back | Apply

Figure 8-34 Standard IP ACL (Add Rule) window

The fields that can be configured are described below:

Parameter	Description
Sequence No.	Enter the ACL rule number here. This value must be between 1 and 65535 . If this value is not specified, the system will automatically generate an ACL rule number for this entry.
Action	Select the action that this rule will take here. Options to choose from are Permit and Deny .
Source	Select and enter the source information here. Options to choose from are Any , Host , and IP . When the Any option is selected, any source traffic will be evaluated according to the conditions of this rule. When the Host option is selected, enter the source host's IP address here. When the IP option is selected, the Wildcard option will also be available. Enter the group of source IP addresses by using a wildcard bitmap. The bit corresponding to the bit value 1 will be ignored. The bit corresponding to the bit value 0 will be checked.
Destination	Select and enter the destination information here. Options to choose from are Any , Host , and IP . When the Any option is selected, any destination traffic will be evaluated according to the conditions of this rule. When the Host option is selected, enter the destination host's IP address here. When the IP option is selected, the Wildcard option will also be available. Enter the group of destination IP addresses by using a wildcard bitmap. The bit corresponding to the bit value 1 will be ignored. The bit corresponding to the bit value 0 will be checked.
Time Range	Enter the name of the time range to associate with this ACL rule.

Click the **Back** button to discard the changes made and return to the previous page.

Click the **Apply** button to accept the changes made.

To enable the **Counter State** option or to enter a **Remark** for the profile, click the **Edit** button, next to the specific ACL profile (found in the ACL profile table).

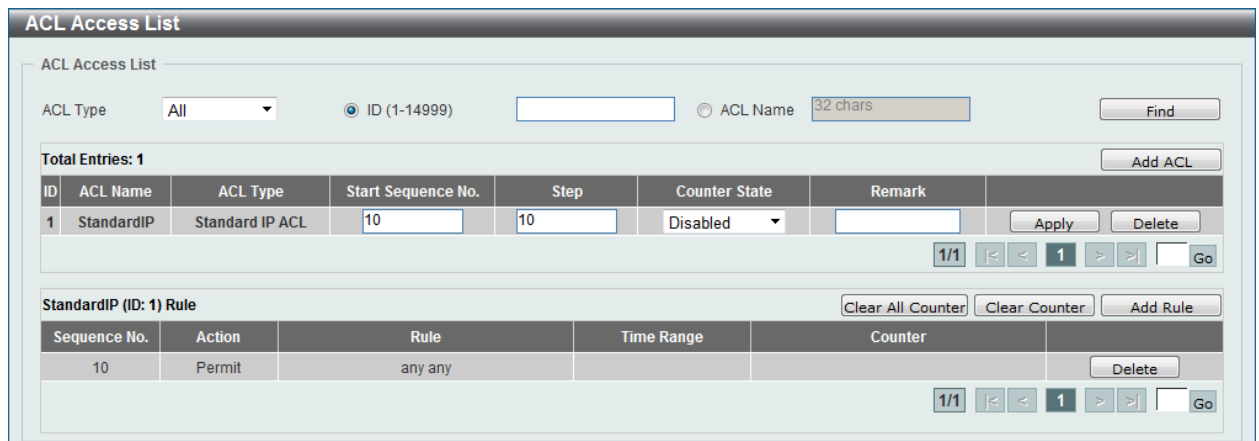

Figure 8-35 Standard IP ACL (Edit ACL) window

The fields that can be configured are described below:

Parameter	Description
Start Sequence No.	Enter the start sequence number here.
Step	Enter the sequence number increment here.
Counter State	Select to enable or disable the counter state option here.

Remark	Enter an optional remark that will be associated with this profile here.
---------------	--

Click the **Apply** button to accept the changes made.

Click the **Delete** button to remove the specific entry.

To view the list of rules, that are associated with an ACL profile, select the ACL profile (found in the ACL profile table). The rule of ACL rules, connected to the selected ACL profile, will be displayed in the ACL rule table, as shown below:

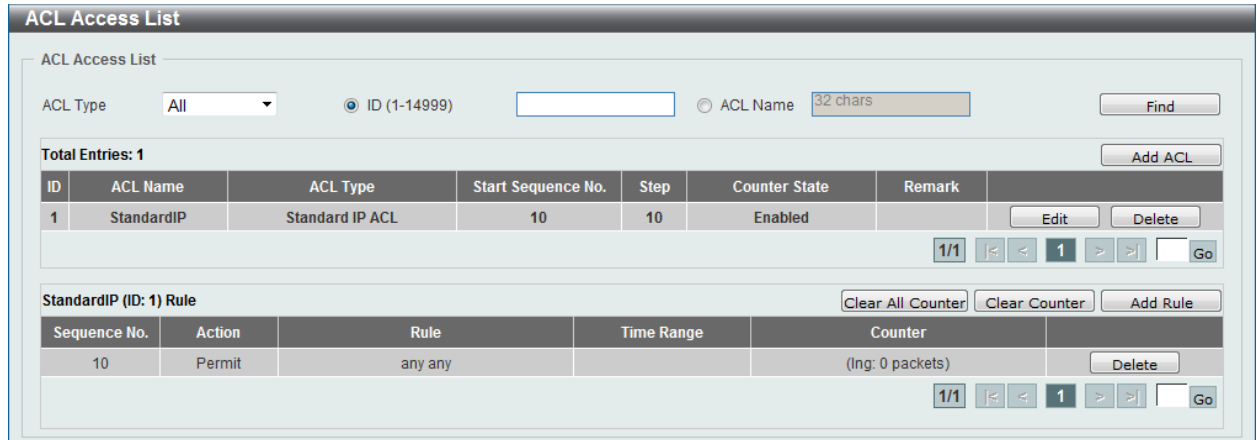

Figure 8-36 Standard IP ACL (Rule Display) window

Click the **Delete** button to remove the specific ACL rule.

Enter a page number and click the **Go** button to navigate to a specific page when multiple pages exist.

Extended IP ACL

After clicking the **Add ACL** button, users can create a new ACL profile, as shown below:

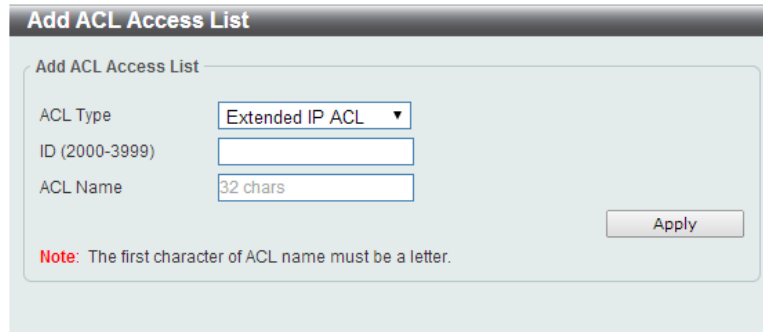

Figure 8-37 Extended IP ACL (Add Profile) window

The fields that can be configured are described below:

Parameter	Description
ACL Type	Select the ACL profile type here. Options to choose from are Standard IP ACL , Extended IP ACL , Standard IPv6 ACL , Extended IPv6 ACL , Extended MAC ACL , and Extended Expert ACL .
ID	Enter the ACL ID from 2000 to 3999.
ACL Name	Enter the ACL profile's name here. This name can be up to 32

characters long.

Click the **Apply** button to create the new ACL profile.

After creating an Extend IP ACL profile, the newly created Extend IP ACL profile will be displayed in the ACL profile display table, as shown below:

ACL Access List

ACL Access List

ACL Type: ID (1-14999) ACL Name

Total Entries: 2

ID	ACL Name	ACL Type	Start Sequence No.	Step	Counter State	Remark	
1	StandardIP	Standard IP ACL	10	10	Enabled		<input type="button" value="Edit"/> <input type="button" value="Delete"/>
2000	ExtendIP	Extended IP ACL	10	10	Disabled		<input type="button" value="Edit"/> <input type="button" value="Delete"/>

1/1 < << 1 >> >

Sequence No.	Action	Rule	Time Range	Counter
--------------	--------	------	------------	---------

Figure 8-38 Extended IP ACL (Main) window

Click the **Edit** button to re-configure the specific ACL profile.

Click the **Delete** button to remove the specific ACL profile.

Enter a page number and click the **Go** button to navigate to a specific page when multiple pages exist.

To add an ACL rule in the ACL profile, select it (the ACL profile will toggle to the bold font), and click the **Add Rule** button.

ACL Access List

ACL Access List

ACL Type: ID (1-14999) ACL Name

Total Entries: 2

ID	ACL Name	ACL Type	Start Sequence No.	Step	Counter State	Remark	
1	StandardIP	Standard IP ACL	10	10	Enabled		<input type="button" value="Edit"/> <input type="button" value="Delete"/>
2000	ExtendIP	Extended IP ACL	10	10	Disabled		<input type="button" value="Edit"/> <input type="button" value="Delete"/>

1/1 < << 1 >> >

ExtendIP (ID: 2000) Rule

Sequence No.	Action	Rule	Time Range	Counter
--------------	--------	------	------------	---------

Figure 8-39 Extended IP ACL (Selected) window

After selecting the ACL profile and clicking the **Add Rule** button, users can configure the new ACL rule, in the selected ACL profile, as shown below:

Figure 8-40 Extended IP ACL (Add Rule) window

This is a dynamic page. Every selection made in the **Protocol Type** drop-down list will change the bottom part of this window.

The **fixed** fields that can be configured are described below:

Parameter	Description
Sequence No.	Enter the ACL rule number here. This value must be between 1 and 65535. If this value is not specified, the system will automatically generate an ACL rule number for this entry.
Action	Select the action that this rule will take here. Options to choose from are Permit and Deny .
Protocol Type	Select the protocol type option here. Options to choose from are TCP , UDP , ICMP , EIGRP , ESP , GRE , IGMP , OSPF , PIM , VRRP , IP-in-IP , PCP , Protocol ID , and None .

After selecting the **TCP** option as the **Protocol Type**, the following page and parameters will be available, as shown below:

Figure 8-41 Extended IP ACL (Add Rule) TCP window

The **dynamic** fields that can be configured are described below:

Parameter	Description
Source	Select and enter the source information here. Options to choose from are Any , Host , and IP . When the Any option is selected, any source traffic will be evaluated according to the conditions of this rule. When the Host option is selected, enter the source host's IP address here. When the IP option is selected, the Wildcard option will also be available. Enter the group of source IP addresses by using a wildcard bitmap. The bit corresponding to the bit value 1 will be ignored. The bit corresponding to the bit value 0 will be checked.
Destination	Select and enter the destination information here. Options to choose from are Any , Host , and IP . When the Any option is selected, any destination traffic will be evaluated according to the conditions of this rule. When the Host option is selected, enter the destination host's IP address here. When the IP option is selected, the Wildcard option will also be available. Enter the group of destination IP addresses by using a wildcard bitmap. The bit corresponding to the bit value 1 will be ignored. The bit corresponding to the bit value 0 will be checked.
Source Port	Select and enter the source port value here. Options to choose from are = , > , < , ≠ , and Range . When selecting the = option, the specific selected port number will be used. When selecting the > option, all ports greater than the selected port, will be used. When selecting the < option, all ports smaller than the selected port, will be used. When selecting the ≠ option, all ports, excluding the selected port, will be used. When selecting the Range option, the start port number and end port number selected, of the range, will be used. Alternatively, the port number(s) can manually be entered in the space(s) provided, if the port number(s) is/are not available in the drop-down list.

Destination Port	Select and enter the destination port value here. Options to choose from are =, >, <, ≠, and Range . When selecting the = option, the specific selected port number will be used. When selecting the > option, all ports greater than the selected port, will be used. When selecting the < option, all ports smaller than the selected port, will be used. When selecting the ≠ option, all ports, excluding the selected port, will be used. When selecting the Range option, the start port number and end port number selected, of the range, will be used. Alternatively, the port number(s) can manually be entered in the space(s) provided, if the port number(s) is/are not available in the drop-down list.
TCP Flag	Tick the appropriate TCP flag option to include the flag in this rule. Options to choose from are ack , fin , psh , rst , syn , and urg .
IP Precedence	Select the IP precedence value used here. Options to choose from are 0 (routine) , 1 (priority) , 2, (immediate) , 3 (flash) , 4 (flash-override) , 5 (critical) , 6 (internet) , and 7 (network) .
ToS	After selecting the IP precedence value, select the Type-of-Service (ToS) value that will be used here. Options to choose from are 0 (normal) , 1 (min-monetary-cost) , 2 (max-reliability) , 3, 4 (max-throughput) , 5, 6, 7, 8 (min-delay) , 9, 10, 11, 12, 13, 14 , and 15 .
DSCP	Select or enter the DSCP value used here. This value must be between 0 and 63.
Time Range	Enter the name of the time range to associate with this ACL rule.

After selecting the **UDP** option as the **Protocol Type**, the following page and parameters will be available, as shown below:

The screenshot shows the 'Add ACL Rule' configuration window. The 'Protocol Type' is set to 'UDP'. The 'Match IP Address' section has 'Any' selected for both Source and Destination. The 'Match Port' section has 'Please Select' for both Source and Destination. The 'IP Precedence' is set to 'Please Select' and 'ToS' is also 'Please Select'. The 'DSCP' is set to 'Please Select'. The 'Time Range' is set to '32 chars'. There are 'Back' and 'Apply' buttons at the bottom right.

Figure 8-42 Extended IP ACL (Add Rule) UDP window

The **dynamic** fields that can be configured are described below:

Parameter	Description
Source	Select and enter the source information here. Options to choose from are Any , Host , and IP . When the Any option is selected, any source traffic will be evaluated according to the conditions of this rule. When the Host option is selected, enter the source host's IP address here. When the IP option is selected, the Wildcard option will also be available. Enter the group of source IP addresses by using a wildcard bitmap. The bit corresponding to the bit value 1 will be ignored. The bit corresponding to the bit value 0 will be checked.
Destination	Select and enter the destination information here. Options to choose from are Any , Host , and IP . When the Any option is selected, any destination traffic will be evaluated according to the conditions of this rule. When the Host option is selected, enter the destination host's IP address here. When the IP option is selected, the Wildcard option will also be available. Enter the group of destination IP addresses by using a wildcard bitmap. The bit corresponding to the bit value 1 will be ignored. The bit corresponding to the bit value 0 will be checked.
Source Port	Select and enter the source port value here. Options to choose from are = , > , < , ≠ , and Range . When selecting the = option, the specific selected port number will be used. When selecting the > option, all ports greater than the selected port, will be used. When selecting the < option, all ports smaller than the selected port, will be used. When selecting the ≠ option, all ports, excluding the selected port, will be used. When selecting the Range option, the start port number and end port number selected, of the range, will be used. Alternatively, the port number(s) can manually be entered in the space(s) provided, if the port number(s) is/are not available in the drop-down list.
Destination Port	Select and enter the destination port value here. Options to choose from are = , > , < , ≠ , and Range . When selecting the = option, the specific selected port number will be used. When selecting the > option, all ports greater than the selected port, will be used. When selecting the < option, all ports smaller than the selected port, will be used. When selecting the ≠ option, all ports, excluding the selected port, will be used. When selecting the Range option, the start port number and end port number selected, of the range, will be used. Alternatively, the port number(s) can manually be entered in the space(s) provided, if the port number(s) is/are not available in the drop-down list.
IP Precedence	Select the IP precedence value used here. Options to choose from are 0 (routine) , 1 (priority) , 2 (immediate) , 3 (flash) , 4 (flash-override) , 5 (critical) , 6 (internet) , and 7 (network) .
ToS	After selecting the IP precedence value, select the Type-of-Service (ToS) value that will be used here. Options to choose from are 0 (normal) , 1 (min-monetary-cost) , 2 (max-reliability) , 3, 4 (max-throughput) , 5, 6, 7, 8 (min-delay) , 9, 10, 11, 12, 13, 14 , and 15 .
DSCP	Select or enter the DSCP value used here. This value must be between 0 and 63.
Time Range	Enter the name of the time range to associate with this ACL rule.

After selecting the **ICMP** option as the **Protocol Type**, the following page and parameters will be available, as shown below:

The screenshot shows the 'Add ACL Rule' configuration window. The 'Protocol Type' is set to 'ICMP'. The 'Match IP Address' section has 'Any' selected for both Source and Destination. The 'Match ICMP' section has 'Specify ICMP Message Type' set to 'Please Select'. The 'IP Precedence' and 'DSCP (0-63)' options are also visible, along with a 'Time Range' field set to '32 chars'. 'Back' and 'Apply' buttons are at the bottom right.

Figure 8-43 Extended IP ACL (Add Rule) ICMP window

The **dynamic** fields that can be configured are described below:

Parameter	Description
Source	Select and enter the source information here. Options to choose from are Any , Host , and IP . When the Any option is selected, any source traffic will be evaluated according to the conditions of this rule. When the Host option is selected, enter the source host's IP address here. When the IP option is selected, the Wildcard option will also be available. Enter the group of source IP addresses by using a wildcard bitmap. The bit corresponding to the bit value 1 will be ignored. The bit corresponding to the bit value 0 will be checked.
Destination	Select and enter the destination information here. Options to choose from are Any , Host , and IP . When the Any option is selected, any destination traffic will be evaluated according to the conditions of this rule. When the Host option is selected, enter the destination host's IP address here. When the IP option is selected, the Wildcard option will also be available. Enter the group of destination IP addresses by using a wildcard bitmap. The bit corresponding to the bit value 1 will be ignored. The bit corresponding to the bit value 0 will be checked.
Specify ICMP Message Type	Select the ICMP message type used here.
ICMP Message Type	When the ICMP message type is not selected in the Specify ICMP Message Type drop-down list, enter the ICMP Message Type numerical value used here. When the ICMP message type is selected in the Specify ICMP Message Type drop-down list, this numerical value will automatically be entered.
Message Code	When the ICMP message type is not selected in the Specify ICMP Message Type drop-down list, enter the Message Code numerical value used here. When the ICMP message type is not selected in the Specify ICMP Message Type drop-down list, this numerical value will

	automatically be entered.
IP Precedence	Select the IP precedence value used here. Options to choose from are 0 (routine) , 1 (priority) , 2, (immediate) , 3 (flash) , 4 (flash-override) , 5 (critical) , 6 (internet) , and 7 (network) .
ToS	After selecting the IP precedence value, select the Type-of-Service (ToS) value that will be used here. Options to choose from are 0 (normal) , 1 (min-monetary-cost) , 2 (max-reliability) , 3, 4 (max-throughput) , 5, 6, 7, 8 (min-delay) , 9, 10, 11, 12, 13, 14, and 15 .
DSCP	Select or enter the DSCP value used here. This value must be between 0 and 63.
Time Range	Enter the name of the time range to associate with this ACL rule.

After selecting the **EIGRP** option as the **Protocol Type**, the following page and parameters will be available, as shown below:

The screenshot shows the 'Add ACL Rule' window for EIGRP. The 'Protocol Type' is set to 'EIGRP'. The 'Match IP Address' section has 'Any' selected for both Source and Destination. The 'IP Precedence' and 'ToS' are set to 'Please Select'. The 'DSCP' is also set to 'Please Select'. The 'Time Range' field contains '32 chars'. There are 'Back' and 'Apply' buttons at the bottom right.

Figure 8-44 Extended IP ACL (Add Rule) EIGRP window

The **dynamic** fields that can be configured are described below:

Parameter	Description
Fragments	Select the Fragments option to include packet fragment filtering.
Source	Select and enter the source information here. Options to choose from are Any , Host , and IP . When the Any option is selected, any source traffic will be evaluated according to the conditions of this rule. When the Host option is selected, enter the source host's IP address here. When the IP option is selected, the Wildcard option will also be available. Enter the group of source IP addresses by using a wildcard bitmap. The bit corresponding to the bit value 1 will be ignored. The bit corresponding to the bit value 0 will be checked.
Destination	Select and enter the destination information here. Options to choose from are Any , Host , and IP . When the Any option is selected, any destination traffic will be evaluated according to the conditions of this rule. When the Host option is selected, enter the destination host's IP address here. When the IP option is selected, the Wildcard option will also be available. Enter the group of destination IP addresses by using

	a wildcard bitmap. The bit corresponding to the bit value 1 will be ignored. The bit corresponding to the bit value 0 will be checked.
IP Precedence	Select the IP precedence value used here. Options to choose from are 0 (routine) , 1 (priority) , 2, (immediate) , 3 (flash) , 4 (flash-override) , 5 (critical) , 6 (internet) , and 7 (network) .
ToS	After selecting the IP precedence value, select the Type-of-Service (ToS) value that will be used here. Options to choose from are 0 (normal) , 1 (min-monetary-cost) , 2 (max-reliability) , 3, 4 (max-throughput) , 5, 6, 7, 8 (min-delay) , 9, 10, 11, 12, 13, 14 , and 15 .
DSCP	Select or enter the DSCP value used here. This value must be between 0 and 63.
Time Range	Enter the name of the time range to associate with this ACL rule.

After selecting the **ESP** option as the **Protocol Type**, the following page and parameters will be available, as shown below:

The screenshot shows the 'Add ACL Rule' window for an Extended IP ACL. The configuration is as follows:

- ID:** 2000
- ACL Name:** ExtendIP
- ACL Type:** Extended IP ACL
- Sequence No. (1-65535):** (empty field)
- Action:** Permit Deny
- Protocol Type:** ESP (dropdown), 50 (input), (0-255) (range), Fragments
- Match IP Address:**
 - Source:** Any, Host, IP, Wildcard (input)
 - Destination:** Any, Host, IP, Wildcard (input)
- IP Precedence:** Please Select (dropdown)
- ToS:** Please Select (dropdown)
- DSCP (0-63):** Please Select (dropdown), (input)
- Time Range:** 32 chars (input)

Figure 8-45 Extended IP ACL (Add Rule) ESP window

The **dynamic** fields that can be configured are described below:

Parameter	Description
Fragments	Select the Fragments option to include packet fragment filtering.
Source	Select and enter the source information here. Options to choose from are Any , Host , and IP . When the Any option is selected, any source traffic will be evaluated according to the conditions of this rule. When the Host option is selected, enter the source host's IP address here. When the IP option is selected, the Wildcard option will also be available. Enter the group of source IP addresses by using a wildcard bitmap. The bit corresponding to the bit value 1 will be ignored. The bit corresponding to the bit value 0 will be checked.
Destination	Select and enter the destination information here. Options to choose from are Any , Host , and IP . When the Any option is selected, any destination traffic will be evaluated according to the conditions of this rule. When the Host option is selected, enter the destination host's IP address here. When the IP option is selected, the Wildcard option will

	also be available. Enter the group of destination IP addresses by using a wildcard bitmap. The bit corresponding to the bit value 1 will be ignored. The bit corresponding to the bit value 0 will be checked.
IP Precedence	Select the IP precedence value used here. Options to choose from are 0 (routine) , 1 (priority) , 2, (immediate) , 3 (flash) , 4 (flash-override) , 5 (critical) , 6 (internet) , and 7 (network) .
ToS	After selecting the IP precedence value, select the Type-of-Service (ToS) value that will be used here. Options to choose from are 0 (normal) , 1 (min-monetary-cost) , 2 (max-reliability) , 3, 4 (max-throughput) , 5, 6, 7, 8 (min-delay) , 9, 10, 11, 12, 13, 14 , and 15 .
DSCP	Select or enter the DSCP value used here. This value must be between 0 and 63.
Time Range	Enter the name of the time range to associate with this ACL rule.

After selecting the **GRE** option as the **Protocol Type**, the following page and parameters will be available, as shown below:

The screenshot shows the 'Add ACL Rule' configuration window. Key parameters include: ID: 2000, ACL Name: ExtendIP, ACL Type: Extended IP ACL, Sequence No. (empty), Action: Permit (selected), Protocol Type: GRE, Match IP Address (Source and Destination), IP Precedence: Please Select, ToS: Please Select, DSCP (0-63): Please Select, and Time Range: 32 chars. There are 'Back' and 'Apply' buttons at the bottom right.

Figure 8-46 Extended IP ACL (Add Rule) GRE window

The **dynamic** fields that can be configured are described below:

Parameter	Description
Fragments	Select the Fragments option to include packet fragment filtering.
Source	Select and enter the source information here. Options to choose from are Any , Host , and IP . When the Any option is selected, any source traffic will be evaluated according to the conditions of this rule. When the Host option is selected, enter the source host's IP address here. When the IP option is selected, the Wildcard option will also be available. Enter the group of source IP addresses by using a wildcard bitmap. The bit corresponding to the bit value 1 will be ignored. The bit corresponding to the bit value 0 will be checked.
Destination	Select and enter the destination information here. Options to choose from are Any , Host , and IP . When the Any option is selected, any destination traffic will be evaluated according to the conditions of this rule. When the Host option is selected, enter the destination host's IP

	address here. When the IP option is selected, the Wildcard option will also be available. Enter the group of destination IP addresses by using a wildcard bitmap. The bit corresponding to the bit value 1 will be ignored. The bit corresponding to the bit value 0 will be checked.
IP Precedence	Select the IP precedence value used here. Options to choose from are 0 (routine) , 1 (priority) , 2 (immediate) , 3 (flash) , 4 (flash-override) , 5 (critical) , 6 (internet) , and 7 (network) .
ToS	After selecting the IP precedence value, select the Type-of-Service (ToS) value that will be used here. Options to choose from are 0 (normal) , 1 (min-monetary-cost) , 2 (max-reliability) , 3, 4 (max-throughput) , 5, 6, 7, 8 (min-delay) , 9, 10, 11, 12, 13, 14 , and 15 .
DSCP	Select or enter the DSCP value used here. This value must be between 0 and 63.
Time Range	Enter the name of the time range to associate with this ACL rule.

After selecting the **IGMP** option as the **Protocol Type**, the following page and parameters will be available, as shown below:

The screenshot shows the 'Add ACL Rule' window for an Extended IP ACL. The configuration is as follows:

- ID:** 2000
- ACL Name:** ExtendIP
- ACL Type:** Extended IP ACL
- Sequence No. (1-65535):** [Empty field] (If it isn't specified, the system automatically assigns.)
- Action:** Permit Deny
- Protocol Type:** IGMP, [2] (0-255), Fragments
- Match IP Address:**
 - Source:** Any, Host, IP, Wildcard [Empty field]
 - Destination:** Any, Host, IP, Wildcard [Empty field]
- IP Precedence:** Please Select, **ToS:** Please Select
- DSCP (0-63):** Please Select, [Empty field]
- Time Range:** 32 chars

Buttons: Back, Apply

Figure 8-47 Extended IP ACL (Add Rule) IGMP window

The **dynamic** fields that can be configured are described below:

Parameter	Description
Fragments	Select the Fragments option to include packet fragment filtering.
Source	Select and enter the source information here. Options to choose from are Any , Host , and IP . When the Any option is selected, any source traffic will be evaluated according to the conditions of this rule. When the Host option is selected, enter the source host's IP address here. When the IP option is selected, the Wildcard option will also be available. Enter the group of source IP addresses by using a wildcard bitmap. The bit corresponding to the bit value 1 will be ignored. The bit corresponding to the bit value 0 will be checked.
Destination	Select and enter the destination information here. Options to choose from are Any , Host , and IP . When the Any option is selected, any destination traffic will be evaluated according to the conditions of this

	rule. When the Host option is selected, enter the destination host's IP address here. When the IP option is selected, the Wildcard option will also be available. Enter the group of destination IP addresses by using a wildcard bitmap. The bit corresponding to the bit value 1 will be ignored. The bit corresponding to the bit value 0 will be checked.
IP Precedence	Select the IP precedence value used here. Options to choose from are 0 (routine) , 1 (priority) , 2 (immediate) , 3 (flash) , 4 (flash-override) , 5 (critical) , 6 (internet) , and 7 (network) .
ToS	After selecting the IP precedence value, select the Type-of-Service (ToS) value that will be used here. Options to choose from are 0 (normal) , 1 (min-monetary-cost) , 2 (max-reliability) , 3, 4 (max-throughput) , 5, 6, 7, 8 (min-delay) , 9, 10, 11, 12, 13, 14 , and 15 .
DSCP	Select or enter the DSCP value used here. This value must be between 0 and 63.
Time Range	Enter the name of the time range to associate with this ACL rule.

After selecting the **OSPF** option as the **Protocol Type**, the following page and parameters will be available, as shown below:

The screenshot shows the 'Add ACL Rule' configuration window for OSPF. The 'Protocol Type' is set to 'OSPF'. The 'Match IP Address' section has 'Any' selected for both Source and Destination. The 'Action' is set to 'Permit'. There are 'Back' and 'Apply' buttons at the bottom right.

Figure 8-48 Extended IP ACL (Add Rule) OSPF window

The **dynamic** fields that can be configured are described below:

Parameter	Description
Fragments	Select the Fragments option to include packet fragment filtering.
Source	Select and enter the source information here. Options to choose from are Any , Host , and IP . When the Any option is selected, any source traffic will be evaluated according to the conditions of this rule. When the Host option is selected, enter the source host's IP address here. When the IP option is selected, the Wildcard option will also be available. Enter the group of source IP addresses by using a wildcard bitmap. The bit corresponding to the bit value 1 will be ignored. The bit corresponding to the bit value 0 will be checked.
Destination	Select and enter the destination information here. Options to choose from are Any , Host , and IP . When the Any option is selected, any

	destination traffic will be evaluated according to the conditions of this rule. When the Host option is selected, enter the destination host's IP address here. When the IP option is selected, the Wildcard option will also be available. Enter the group of destination IP addresses by using a wildcard bitmap. The bit corresponding to the bit value 1 will be ignored. The bit corresponding to the bit value 0 will be checked.
IP Precedence	Select the IP precedence value used here. Options to choose from are 0 (routine) , 1 (priority) , 2, (immediate) , 3 (flash) , 4 (flash-override) , 5 (critical) , 6 (internet) , and 7 (network) .
ToS	After selecting the IP precedence value, select the Type-of-Service (ToS) value that will be used here. Options to choose from are 0 (normal) , 1 (min-monetary-cost) , 2 (max-reliability) , 3, 4 (max-throughput) , 5, 6, 7, 8 (min-delay) , 9, 10, 11, 12, 13, 14 , and 15 .
DSCP	Select or enter the DSCP value used here. This value must be between 0 and 63.
Time Range	Enter the name of the time range to associate with this ACL rule.

After selecting the **PIM** option as the **Protocol Type**, the following page and parameters will be available, as shown below:

The screenshot shows the 'Add ACL Rule' configuration window for PIM. The 'Protocol Type' is set to PIM. The 'Match IP Address' section has 'Any' selected for both Source and Destination. The 'Action' is set to 'Permit'. The 'IP Precedence' and 'ToS' are set to 'Please Select'. The 'DSCP' is set to 'Please Select'. The 'Time Range' is set to '32 chars'. There are 'Back' and 'Apply' buttons at the bottom right.

Figure 8-49 Extended IP ACL (Add Rule) PIM window

The **dynamic** fields that can be configured are described below:

Parameter	Description
Fragments	Select the Fragments option to include packet fragment filtering.
Source	Select and enter the source information here. Options to choose from are Any , Host , and IP . When the Any option is selected, any source traffic will be evaluated according to the conditions of this rule. When the Host option is selected, enter the source host's IP address here. When the IP option is selected, the Wildcard option will also be available. Enter the group of source IP addresses by using a wildcard bitmap. The bit corresponding to the bit value 1 will be ignored. The bit corresponding to the bit value 0 will be checked.
Destination	Select and enter the destination information here. Options to choose

	from are Any , Host , and IP . When the Any option is selected, any destination traffic will be evaluated according to the conditions of this rule. When the Host option is selected, enter the destination host's IP address here. When the IP option is selected, the Wildcard option will also be available. Enter the group of destination IP addresses by using a wildcard bitmap. The bit corresponding to the bit value 1 will be ignored. The bit corresponding to the bit value 0 will be checked.
IP Precedence	Select the IP precedence value used here. Options to choose from are 0 (routine) , 1 (priority) , 2, (immediate) , 3 (flash) , 4 (flash-override) , 5 (critical) , 6 (internet) , and 7 (network) .
ToS	After selecting the IP precedence value, select the Type-of-Service (ToS) value that will be used here. Options to choose from are 0 (normal) , 1 (min-monetary-cost) , 2 (max-reliability) , 3, 4 (max-throughput) , 5, 6, 7, 8 (min-delay) , 9, 10, 11, 12, 13, 14 , and 15 .
DSCP	Select or enter the DSCP value used here. This value must be between 0 and 63.
Time Range	Enter the name of the time range to associate with this ACL rule.

After selecting the **VRRP** option as the **Protocol Type**, the following page and parameters will be available, as shown below:

The screenshot shows the 'Add ACL Rule' window for VRRP. The configuration is as follows:

- ID:** 2000
- ACL Name:** ExtendIP
- ACL Type:** Extended IP ACL
- Sequence No. (1-65535):** [Empty field] (If it isn't specified, the system automatically assigns.)
- Action:** Permit Deny
- Protocol Type:** VRRP, [112] (0-255), Fragments
- Match IP Address:**
 - Source:** Any, Host, IP, Wildcard [Empty field]
 - Destination:** Any, Host, IP, Wildcard [Empty field]
- IP Precedence:** Please Select, **ToS:** Please Select
- DSCP (0-63):** Please Select, [Empty field]
- Time Range:** 32 chars
- Buttons:** Back, Apply

Figure 8-50 Extended IP ACL (Add Rule) VRRP window

The **dynamic** fields that can be configured are described below:

Parameter	Description
Fragments	Select the Fragments option to include packet fragment filtering.
Source	Select and enter the source information here. Options to choose from are Any , Host , and IP . When the Any option is selected, any source traffic will be evaluated according to the conditions of this rule. When the Host option is selected, enter the source host's IP address here. When the IP option is selected, the Wildcard option will also be available. Enter the group of source IP addresses by using a wildcard bitmap. The bit corresponding to the bit value 1 will be ignored. The bit corresponding to the bit value 0 will be checked.

Destination	Select and enter the destination information here. Options to choose from are Any , Host , and IP . When the Any option is selected, any destination traffic will be evaluated according to the conditions of this rule. When the Host option is selected, enter the destination host's IP address here. When the IP option is selected, the Wildcard option will also be available. Enter the group of destination IP addresses by using a wildcard bitmap. The bit corresponding to the bit value 1 will be ignored. The bit corresponding to the bit value 0 will be checked.
IP Precedence	Select the IP precedence value used here. Options to choose from are 0 (routine) , 1 (priority) , 2, (immediate) , 3 (flash) , 4 (flash-override) , 5 (critical) , 6 (internet) , and 7 (network) .
ToS	After selecting the IP precedence value, select the Type-of-Service (ToS) value that will be used here. Options to choose from are 0 (normal) , 1 (min-monetary-cost) , 2 (max-reliability) , 3, 4 (max-throughput) , 5, 6, 7, 8 (min-delay) , 9, 10, 11, 12, 13, 14 , and 15 .
DSCP	Select or enter the DSCP value used here. This value must be between 0 and 63.
Time Range	Enter the name of the time range to associate with this ACL rule.

After selecting the **IP-in-IP** option as the **Protocol Type**, the following page and parameters will be available, as shown below:

Figure 8-51 Extended IP ACL (Add Rule) IP-in-IP window

The **dynamic** fields that can be configured are described below:

Parameter	Description
Fragments	Select the Fragments option to include packet fragment filtering.
Source	Select and enter the source information here. Options to choose from are Any , Host , and IP . When the Any option is selected, any source traffic will be evaluated according to the conditions of this rule. When the Host option is selected, enter the source host's IP address here. When the IP option is selected, the Wildcard option will also be available. Enter the group of source IP addresses by using a wildcard bitmap. The bit corresponding to the bit value 1 will be ignored. The bit

	corresponding to the bit value 0 will be checked.
Destination	Select and enter the destination information here. Options to choose from are Any , Host , and IP . When the Any option is selected, any destination traffic will be evaluated according to the conditions of this rule. When the Host option is selected, enter the destination host's IP address here. When the IP option is selected, the Wildcard option will also be available. Enter the group of destination IP addresses by using a wildcard bitmap. The bit corresponding to the bit value 1 will be ignored. The bit corresponding to the bit value 0 will be checked.
IP Precedence	Select the IP precedence value used here. Options to choose from are 0 (routine) , 1 (priority) , 2, (immediate) , 3 (flash) , 4 (flash-override) , 5 (critical) , 6 (internet) , and 7 (network) .
ToS	After selecting the IP precedence value, select the Type-of-Service (ToS) value that will be used here. Options to choose from are 0 (normal) , 1 (min-monetary-cost) , 2 (max-reliability) , 3, 4 (max-throughput) , 5, 6, 7, 8 (min-delay) , 9, 10, 11, 12, 13, 14, and 15 .
DSCP	Select or enter the DSCP value used here. This value must be between 0 and 63.
Time Range	Enter the name of the time range to associate with this ACL rule.

After selecting the **PCP** option as the **Protocol Type**, the following page and parameters will be available, as shown below:

The screenshot shows the 'Add ACL Rule' window for the PCP protocol. The configuration includes:

- ID:** 2000
- ACL Name:** ExtendIP
- ACL Type:** Extended IP ACL
- Sequence No.:** (1-65535) [] (If it isn't specified, the system automatically assigns.)
- Action:** Permit Deny
- Protocol Type:** PCP [] 108 (0-255) Fragments
- Match IP Address:**
 - Source:** Any, Host [], IP []
 - Destination:** Any, Host [], IP []
 - Wildcard:** []
- IP Precedence:** Please Select [] **ToS:** Please Select []
- DSCP (0-63):** Please Select [] []
- Time Range:** 32 chars []

 Buttons for 'Back' and 'Apply' are visible at the bottom right.

Figure 8-52 Extended IP ACL (Add Rule) PCP window

The **dynamic** fields that can be configured are described below:

Parameter	Description
Fragments	Select the Fragments option to include packet fragment filtering.
Source	Select and enter the source information here. Options to choose from are Any , Host , and IP . When the Any option is selected, any source traffic will be evaluated according to the conditions of this rule. When the Host option is selected, enter the source host's IP address here. When the IP option is selected, the Wildcard option will also be available. Enter the group of source IP addresses by using a wildcard

	bitmap. The bit corresponding to the bit value 1 will be ignored. The bit corresponding to the bit value 0 will be checked.
Destination	Select and enter the destination information here. Options to choose from are Any , Host , and IP . When the Any option is selected, any destination traffic will be evaluated according to the conditions of this rule. When the Host option is selected, enter the destination host's IP address here. When the IP option is selected, the Wildcard option will also be available. Enter the group of destination IP addresses by using a wildcard bitmap. The bit corresponding to the bit value 1 will be ignored. The bit corresponding to the bit value 0 will be checked.
IP Precedence	Select the IP precedence value used here. Options to choose from are 0 (routine) , 1 (priority) , 2, (immediate) , 3 (flash) , 4 (flash-override) , 5 (critical) , 6 (internet) , and 7 (network) .
ToS	After selecting the IP precedence value, select the Type-of-Service (ToS) value that will be used here. Options to choose from are 0 (normal) , 1 (min-monetary-cost) , 2 (max-reliability) , 3, 4 (max-throughput) , 5, 6, 7, 8 (min-delay) , 9, 10, 11, 12, 13, 14, and 15 .
DSCP	Select or enter the DSCP value used here. This value must be between 0 and 63.
Time Range	Enter the name of the time range to associate with this ACL rule.

After selecting the **Protocol ID** option as the **Protocol Type**, the following page and parameters will be available, as shown below:

Figure 8-53 Extended IP ACL (Add Rule) Protocol ID window

The **dynamic** fields that can be configured are described below:

Parameter	Description
Protocol	Enter the Protocol ID value in the space provided. This value must be between 0 and 255.
Fragments	Select the Fragments option to include packet fragment filtering.
Source	Select and enter the source information here. Options to choose from are Any , Host , and IP . When the Any option is selected, any source traffic will be evaluated according to the conditions of this rule. When

	the Host option is selected, enter the source host's IP address here. When the IP option is selected, the Wildcard option will also be available. Enter the group of source IP addresses by using a wildcard bitmap. The bit corresponding to the bit value 1 will be ignored. The bit corresponding to the bit value 0 will be checked.
Destination	Select and enter the destination information here. Options to choose from are Any , Host , and IP . When the Any option is selected, any destination traffic will be evaluated according to the conditions of this rule. When the Host option is selected, enter the destination host's IP address here. When the IP option is selected, the Wildcard option will also be available. Enter the group of destination IP addresses by using a wildcard bitmap. The bit corresponding to the bit value 1 will be ignored. The bit corresponding to the bit value 0 will be checked.
IP Precedence	Select the IP precedence value used here. Options to choose from are 0 (routine) , 1 (priority) , 2, (immediate) , 3 (flash) , 4 (flash-override) , 5 (critical) , 6 (internet) , and 7 (network) .
ToS	After selecting the IP precedence value, select the Type-of-Service (ToS) value that will be used here. Options to choose from are 0 (normal) , 1 (min-monetary-cost) , 2 (max-reliability) , 3, 4 (max-throughput) , 5, 6, 7, 8 (min-delay) , 9, 10, 11, 12, 13, 14, and 15 .
DSCP	Select or enter the DSCP value used here. This value must be between 0 and 63.
Time Range	Enter the name of the time range to associate with this ACL rule.

After selecting the **None** option as the **Protocol Type**, the following page and parameters will be available, as shown below:

Figure 8-54 Extended IP ACL (Add Rule) None window

The **dynamic** fields that can be configured are described below:

Parameter	Description
Fragments	Select the Fragments option to include packet fragment filtering.
Source	Select and enter the source information here. Options to choose from are Any , Host , and IP . When the Any option is selected, any source

	traffic will be evaluated according to the conditions of this rule. When the Host option is selected, enter the source host's IP address here. When the IP option is selected, the Wildcard option will also be available. Enter the group of source IP addresses by using a wildcard bitmap. The bit corresponding to the bit value 1 will be ignored. The bit corresponding to the bit value 0 will be checked.
Destination	Select and enter the destination information here. Options to choose from are Any , Host , and IP . When the Any option is selected, any destination traffic will be evaluated according to the conditions of this rule. When the Host option is selected, enter the destination host's IP address here. When the IP option is selected, the Wildcard option will also be available. Enter the group of destination IP addresses by using a wildcard bitmap. The bit corresponding to the bit value 1 will be ignored. The bit corresponding to the bit value 0 will be checked.
IP Precedence	Select the IP precedence value used here. Options to choose from are 0 (routine) , 1 (priority) , 2, (immediate) , 3 (flash) , 4 (flash-override) , 5 (critical) , 6 (internet) , and 7 (network) .
ToS	After selecting the IP precedence value, select the Type-of-Service (ToS) value that will be used here. Options to choose from are 0 (normal) , 1 (min-monetary-cost) , 2 (max-reliability) , 3, 4 (max-throughput) , 5, 6, 7, 8 (min-delay) , 9, 10, 11, 12, 13, 14, and 15 .
DSCP	Select or enter the DSCP value used here. This value must be between 0 and 63.
Time Range	Enter the name of the time range to associate with this ACL rule.

Click the **Back** button to discard the changes made and return to the previous page.

Click the **Apply** button to accept the changes made.

To enable the **Counter State** option or to enter a **Remark** for the profile, click the **Edit** button, next to the specific ACL profile (found in the ACL profile table).

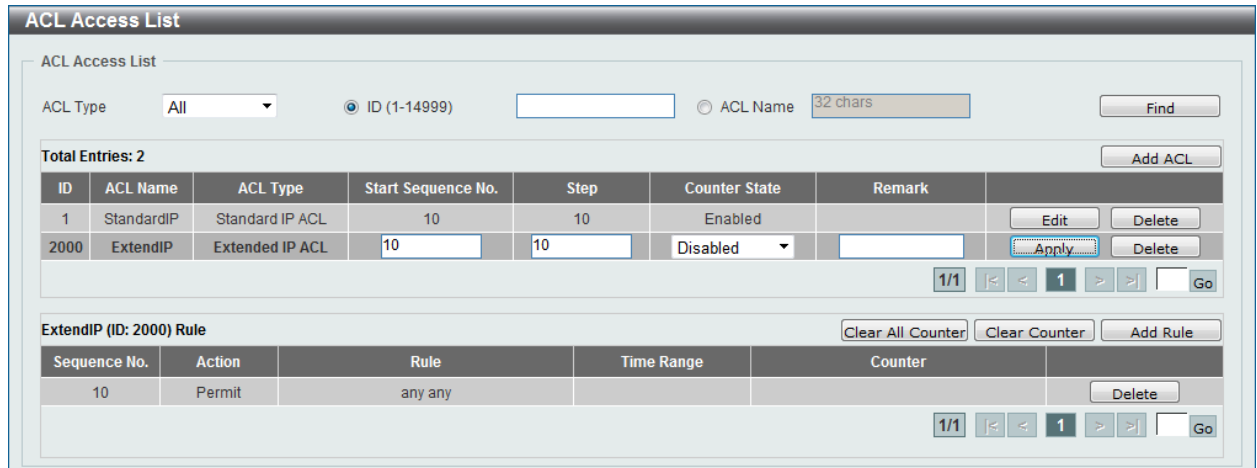

Figure 8-55 Extended IP ACL (Edit ACL) window

The fields that can be configured are described below:

Parameter	Description
Start Sequence No.	Enter the start sequence number here.
Step	Enter the sequence number increment here.
Counter State	Select to enable or disable the counter state option here.

Remark	Enter an optional remark that will be associated with this profile here.
---------------	--

Click the **Apply** button to accept the changes made.

Click the **Delete** button to remove the specific entry.

To view the list of rules, that are associated with an ACL profile, select the ACL profile (found in the ACL profile table). The rule of ACL rules, connected to the selected ACL profile, will be displayed in the ACL rule table, as shown below:

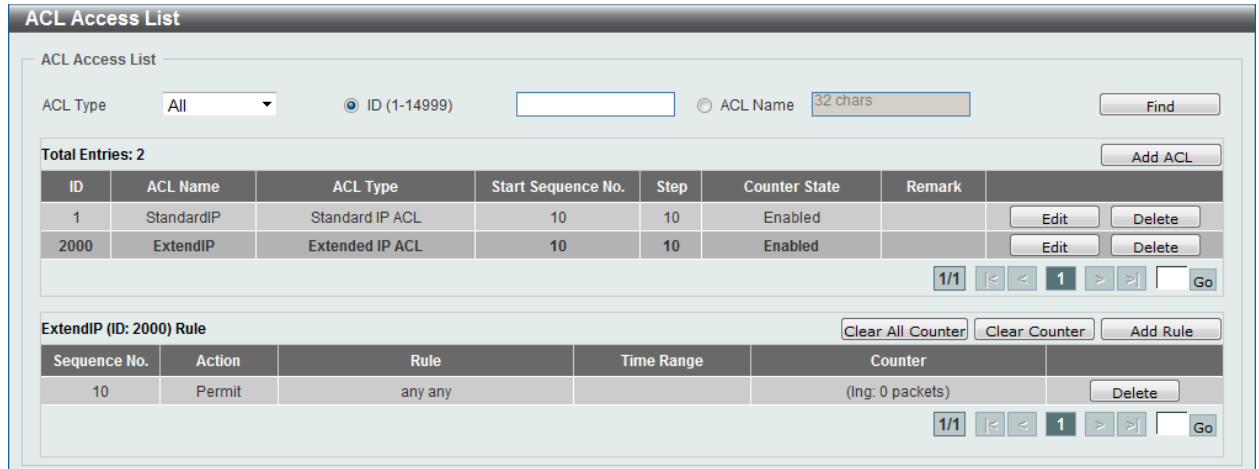

Figure 8-56 Extended IP ACL (Rule Display) window

Click the **Delete** button to remove the specific ACL rule.

Enter a page number and click the **Go** button to navigate to a specific page when multiple pages exist.

Standard IPv6 ACL

After clicking the **Add ACL** button, users can create a new ACL profile, as shown below:

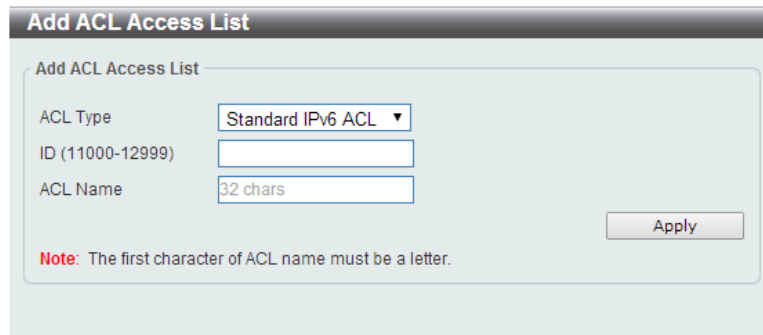

Figure 8-57 Standard IPv6 ACL (Add Profile) window

The fields that can be configured are described below:

Parameter	Description
ACL Type	Select the ACL profile type here. Options to choose from are Standard IP ACL , Extended IP ACL , Standard IPv6 ACL , Extended IPv6 ACL , Extended MAC ACL , and Extended Expert ACL .
ID	Enter the ACL ID from 11000 to 12999.

ACL Name	Enter the ACL profile's name here. This name can be up to 32 characters long.
-----------------	---

Click the **Apply** button to create the new ACL profile.

After creating a Standard IPv6 ACL profile, the newly created Standard IPv6 ACL profile will be displayed in the ACL profile display table, as shown below:

ACL Access List

ACL Access List

ACL Type: All | ID (1-14999) | ACL Name: 32 chars | Find

Total Entries: 3 | Add ACL

ID	ACL Name	ACL Type	Start Sequence No.	Step	Counter State	Remark	
1	StandardIP	Standard IP ACL	10	10	Enabled		Edit Delete
2000	ExtendIP	Extended IP ACL	10	10	Enabled		Edit Delete
11000	Standardv6	Standard IPv6 ACL	10	10	Disabled		Edit Delete

1/1 | < < 1 > > | Go

Clear All Counter | Clear Counter | Add Rule

Sequence No.	Action	Rule	Time Range	Counter

Figure 8-58 Standard IPv6 ACL (Main) window

Click the **Edit** button to re-configure the specific ACL profile.

Click the **Delete** button to remove the specific ACL profile.

Enter a page number and click the **Go** button to navigate to a specific page when multiple pages exist.

To add an ACL rule in the ACL profile, select it (the ACL profile will toggle to the bold font), and click the **Add Rule** button.

ACL Access List

ACL Access List

ACL Type: All | ID (1-14999) | ACL Name: 32 chars | Find

Total Entries: 3 | Add ACL

ID	ACL Name	ACL Type	Start Sequence No.	Step	Counter State	Remark	
1	StandardIP	Standard IP ACL	10	10	Enabled		Edit Delete
2000	ExtendIP	Extended IP ACL	10	10	Enabled		Edit Delete
11000	Standardv6	Standard IPv6 ACL	10	10	Disabled		Edit Delete

1/1 | < < 1 > > | Go

Standardv6 (ID: 11000) Rule | Clear All Counter | Clear Counter | Add Rule

Sequence No.	Action	Rule	Time Range	Counter

Figure 8-59 Standard IPv6 ACL (Selected) window

After selecting the ACL profile and clicking the **Add Rule** button, users can configure the new ACL rule, in the selected ACL profile, as shown below:

Figure 8-60 Standard IPv6 ACL (Add Rule) window

The fields that can be configured are described below:

Parameter	Description
Rule Number	Enter the ACL rule number here. This value must be between 1 and 65535 . If this value is not specified, the system will automatically generate an ACL rule number for this entry.
Action	Select the action that this rule will take here. Options to choose from are Permit and Deny .
Source	Select and enter the source information here. Options to choose from are Any , Host , and IPv6 . When the Any option is selected, any source traffic will be evaluated according to the conditions of this rule. When the Host option is selected, enter the source host's IPv6 address here. When the IPv6 option is selected, the Prefix Length option will also be available. Enter the source IPv6 address and prefix length value in the spaces provided.
Destination	Select and enter the destination information here. Options to choose from are Any , Host , and IPv6 . When the Any option is selected, any destination traffic will be evaluated according to the conditions of this rule. When the Host option is selected, enter the destination host's IPv6 address here. When the IPv6 option is selected, the Prefix Length option will also be available. Enter the destination IPv6 address and prefix length value in the spaces provided.
Time Range	Enter the name of the time range to associate with this ACL rule.

Click the **Back** button to discard the changes made and return to the previous page.

Click the **Apply** button to accept the changes made.

To enable the **Counter State** option or to enter a **Remark** for the profile, click the **Edit** button, next to the specific ACL profile (found in the ACL profile table).

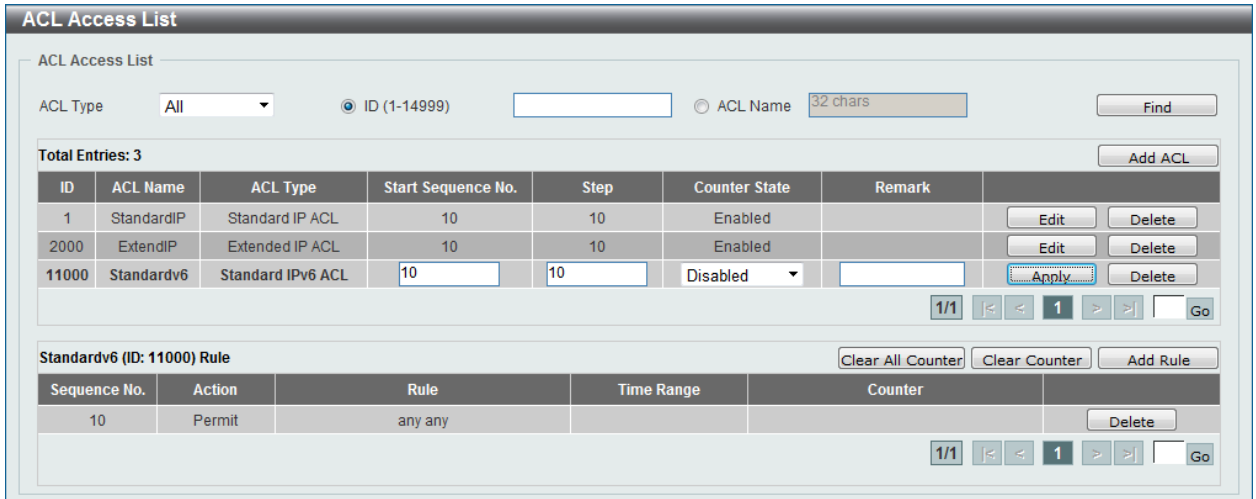

Figure 8-61 Standard IPv6 ACL (Edit ACL) window

The fields that can be configured are described below:

Parameter	Description
Start Sequence No.	Enter the start sequence number here.
Step	Enter the sequence number increment here.
Counter State	Select to enable or disable the counter state option here.
Remark	Enter an optional remark that will be associated with this profile here.

Click the **Apply** button to accept the changes made.

Click the **Delete** button to remove the specific entry.

To view the list of rules, that are associated with an ACL profile, select the ACL profile (found in the ACL profile table). The rule of ACL rules, connected to the selected ACL profile, will be displayed in the ACL rule table, as shown below:

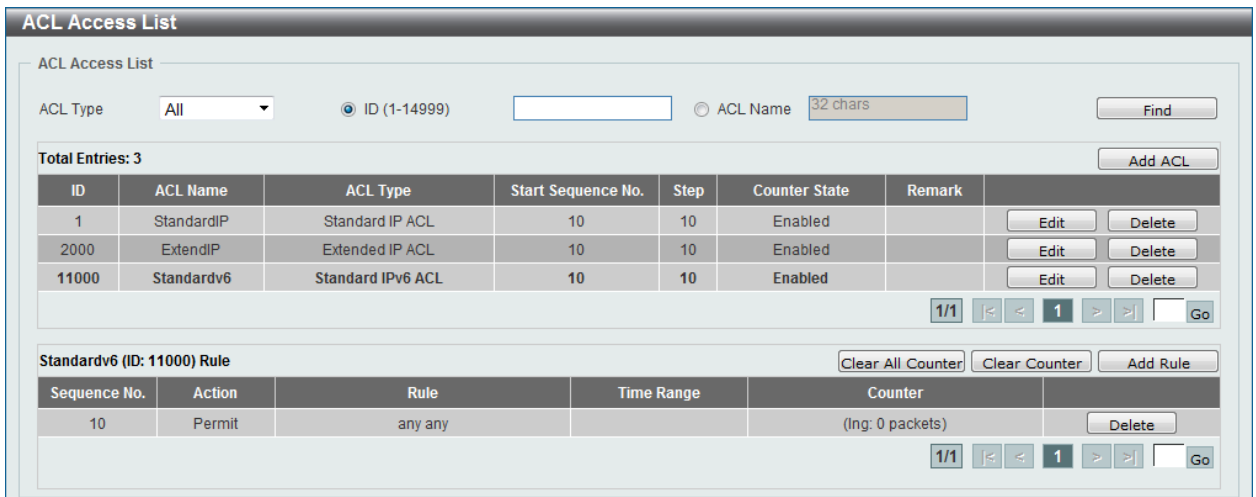

Figure 8-62 Standard IPv6 ACL (Rule Display) window

Click the **Delete** button to remove the specific ACL rule.

Enter a page number and click the **Go** button to navigate to a specific page when multiple pages exist.

Extended IPv6 ACL

After clicking the **Add ACL** button, users can create a new ACL profile, as shown below:

Figure 8-63 Extended IPv6 ACL (Add Profile) window

The fields that can be configured are described below:

Parameter	Description
ACL Type	Select the ACL profile type here. Options to choose from are Standard IP ACL , Extended IP ACL , Standard IPv6 ACL , Extended IPv6 ACL , Extended MAC ACL , and Extended Expert ACL .
ID	Enter the ACL ID from 13000 to 14999.
ACL Name	Enter the ACL profile's name here. This name can be up to 32 characters long.

Click the **Apply** button to create the new ACL profile.

After creating an Extend IPv6 ACL profile, the newly created Extend IPv6 ACL profile will be displayed in the ACL profile display table, as shown below:

ID	ACL Name	ACL Type	Start Sequence No.	Step	Counter State	Remark
1	StandardIP	Standard IP ACL	10	10	Enabled	
2000	ExtendIP	Extended IP ACL	10	10	Enabled	
11000	Standardv6	Standard IPv6 ACL	10	10	Enabled	
13000	Extendv6	Extended IPv6 ACL	10	10	Disabled	

Figure 8-64 Extended IPv6 ACL (Main) window

Click the **Edit** button to re-configure the specific ACL profile.

Click the **Delete** button to remove the specific ACL profile.

Enter a page number and click the **Go** button to navigate to a specific page when multiple pages exist.

To add an ACL rule in the ACL profile, select it (the ACL profile will toggle to the bold font), and click the **Add Rule** button.

ACL Access List

ACL Access List

ACL Type: All | ID (1-14999) | ACL Name: 32 chars | Find

Total Entries: 4 | Add ACL

ID	ACL Name	ACL Type	Start Sequence No.	Step	Counter State	Remark	Edit	Delete
1	StandardIP	Standard IP ACL	10	10	Enabled		Edit	Delete
2000	ExtendIP	Extended IP ACL	10	10	Enabled		Edit	Delete
11000	Standardv6	Standard IPv6 ACL	10	10	Enabled		Edit	Delete
13000	Extendv6	Extended IPv6 ACL	10	10	Disabled		Edit	Delete

1/1 | 1 | Go

Extendv6 (ID: 13000) Rule | Clear All Counter | Clear Counter | Add Rule

Sequence No.	Action	Rule	Time Range	Counter

Figure 8-65 Extended IPv6 ACL (Selected) window

After selecting the ACL profile and clicking the **Add Rule** button, users can configure the new ACL rule, in the selected ACL profile, as shown below:

Add ACL Rule

Add ACL Rule

ID: 13000
 ACL Name: Extendv6
 ACL Type: Extended IPv6 ACL
 Sequence No. (1-65535): (If it isn't specified, the system automatically assigns.)
 Action: Permit Deny
 Protocol Type: TCP (0-255) Fragments

Match IPv6 Address

Source: Any Host (2012::1) IPv6 (2012::1) Prefix Length:
 Destination: Any Host (2012::1) IPv6 (2012::1) Prefix Length:

Match Port

Source Port: Please Select (0-65535) Please Select (0-65535)
 Destination Port: Please Select (0-65535) Please Select (0-65535)

TCP Flag: ack fin psh rst syn urg
 DSCP (0-63): Please Select
 Flow Label (0-1048575):
 Time Range: 32 chars

Back Apply

Figure 8-66 Extended IPv6 ACL (Add Rule) window

This is a dynamic page. Every selection made in the **Protocol Type** option will change the bottom part of this window.

The **fixed** fields that can be configured are described below:

Parameter	Description
-----------	-------------

Sequence No.	Enter the ACL rule number here. This value must be between 1 and 65535. If this value is not specified, the system will automatically generate an ACL rule number for this entry.
Action	Select the action that this rule will take here. Options to choose from are Permit and Deny .
Protocol Type	Select the protocol type option here. Options to choose from are TCP , UDP , ICMP , Protocol ID , ESP , PCP , SCTP , and None .

After selecting the **TCP** option as the **Protocol Type**, the following page and parameters will be available, as shown below:

Figure 8-67 Extended IPv6 ACL (Add Rule) TCP window

The **dynamic** fields that can be configured are described below:

Parameter	Description
Source	Select and enter the source information here. Options to choose from are Any , Host , and IPv6 . When the Any option is selected, any source traffic will be evaluated according to the conditions of this rule. When the Host option is selected, enter the source host's IPv6 address here. When the IPv6 option is selected, the Prefix Length option will also be available. Enter the source IPv6 address and prefix length value in the spaces provided.
Destination	Select and enter the destination information here. Options to choose from are Any , Host , and IPv6 . When the Any option is selected, any destination traffic will be evaluated according to the conditions of this rule. When the Host option is selected, enter the destination host's IPv6 address here. When the IPv6 option is selected, the Prefix Length option will also be available. Enter the destination IPv6 address and prefix length value in the spaces provided.

Source Port	Select and enter the source port value here. Options to choose from are =, >, <, ≠, and Range . When selecting the = option, the specific selected port number will be used. When selecting the > option, all ports greater than the selected port, will be used. When selecting the < option, all ports smaller than the selected port, will be used. When selecting the ≠ option, all ports, excluding the selected port, will be used. When selecting the Range option, the start port number and end port number selected, of the range, will be used. Alternatively, the port number(s) can manually be entered in the space(s) provided, if the port number(s) is/are not available in the drop-down list.
Destination Port	Select and enter the destination port value here. Options to choose from are =, >, <, ≠, and Range . When selecting the = option, the specific selected port number will be used. When selecting the > option, all ports greater than the selected port, will be used. When selecting the < option, all ports smaller than the selected port, will be used. When selecting the ≠ option, all ports, excluding the selected port, will be used. When selecting the Range option, the start port number and end port number selected, of the range, will be used. Alternatively, the port number(s) can manually be entered in the space(s) provided, if the port number(s) is/are not available in the drop-down list.
TCP Flag	Tick the appropriate TCP flag option to include the flag in this rule. Options to choose from are ack , fin , psh , rst , syn , and urg .
DSCP	Select or enter the DSCP value used here. This value must be between 0 and 63.
Flow Label	Enter the flow label value here. This value must be between 0 and 1048575.
Time Range	Enter the name of the time range to associate with this ACL rule.

After selecting the **UDP** option as the **Protocol Type**, the following page and parameters will be available, as shown below:

Figure 8-68 Extended IPv6 ACL (Add Rule) UDP window

The **dynamic** fields that can be configured are described below:

Parameter	Description
Source	Select and enter the source information here. Options to choose from are Any , Host , and IPv6 . When the Any option is selected, any source traffic will be evaluated according to the conditions of this rule. When the Host option is selected, enter the source host's IPv6 address here. When the IPv6 option is selected, the Prefix Length option will also be available. Enter the source IPv6 address and prefix length value in the spaces provided.
Destination	Select and enter the destination information here. Options to choose from are Any , Host , and IPv6 . When the Any option is selected, any destination traffic will be evaluated according to the conditions of this rule. When the Host option is selected, enter the destination host's IPv6 address here. When the IPv6 option is selected, the Prefix Length option will also be available. Enter the destination IPv6 address and prefix length value in the spaces provided.
Source Port	Select and enter the source port value here. Options to choose from are = , > , < , ≠ , and Range . When selecting the = option, the specific selected port number will be used. When selecting the > option, all ports greater than the selected port, will be used. When selecting the < option, all ports smaller than the selected port, will be used. When selecting the ≠ option, all ports, excluding the selected port, will be used. When selecting the Range option, the start port number and end port number selected, of the range, will be used. Alternatively, the port number(s) can manually be entered in the space(s) provided, if the port number(s) is/are not available in the drop-down list.
Destination Port	Select and enter the destination port value here. Options to choose

	from are =, >, <, ≠, and Range . When selecting the = option, the specific selected port number will be used. When selecting the > option, all ports greater than the selected port, will be used. When selecting the < option, all ports smaller than the selected port, will be used. When selecting the ≠ option, all ports, excluding the selected port, will be used. When selecting the Range option, the start port number and end port number selected, of the range, will be used. Alternatively, the port number(s) can manually be entered in the space(s) provided, if the port number(s) is/are not available in the drop-down list.
DSCP	Select or enter the DSCP value used here. This value must be between 0 and 63.
Flow Label	Enter the flow label value here. This value must be between 0 and 1048575.
Time Range	Enter the name of the time range to associate with this ACL rule.

After selecting the **ICMP** option as the **Protocol Type**, the following page and parameters will be available, as shown below:

Figure 8-69 Extended IPv6 ACL (Add Rule) ICMP window

The **dynamic** fields that can be configured are described below:

Parameter	Description
Source	Select and enter the source information here. Options to choose from are Any , Host , and IPv6 . When the Any option is selected, any source traffic will be evaluated according to the conditions of this rule. When the Host option is selected, enter the source host's IPv6 address here. When the IPv6 option is selected, the Prefix Length option will also be available. Enter the source IPv6 address and prefix length value in the spaces provided.
Destination	Select and enter the destination information here. Options to choose from are Any , Host , and IPv6 . When the Any option is selected, any

	destination traffic will be evaluated according to the conditions of this rule. When the Host option is selected, enter the destination host's IPv6 address here. When the IPv6 option is selected, the Prefix Length option will also be available. Enter the destination IPv6 address and prefix length value in the spaces provided.
Specify ICMP Message Type	Select the ICMP message type used here.
ICMP Message Type	When the ICMP Message Type is not selected in the Specify ICMP Message Type drop-down list, enter the ICMP Message Type numerical value used here. When the ICMP Message Type is selected in the Specify ICMP Message Type drop-down list, this numerical value will automatically be entered.
Message Code	When the ICMP Message Type is not selected in the Specify ICMP Message Type drop-down list, enter the Message Code numerical value used here. When the ICMP Message Type is selected in the Specify ICMP Message Type drop-down list, this numerical value will automatically be entered.
DSCP	Select or enter the DSCP value used here. This value must be between 0 and 63.
Flow Label	Enter the flow label value here. This value must be between 0 and 1048575.
Time Range	Enter the name of the time range to associate with this ACL rule.

After selecting the **Protocol ID** option as the **Protocol Type**, the following page and parameters will be available, as shown below:

The screenshot shows the 'Add ACL Rule' configuration window. The 'Protocol Type' is set to 'Protocol ID'. The 'Match IPv6 Address' section is expanded, showing 'Source' and 'Destination' options with radio buttons for 'Any', 'Host', and 'IPv6'. The 'Host' option is selected for both source and destination, with the value '2012::1' entered in the text boxes. There are also 'Prefix Length' text boxes for both source and destination. Other fields include 'ID' (13000), 'ACL Name' (Extendv6), 'ACL Type' (Extended IPv6 ACL), 'Sequence No.' (empty), 'Action' (Permit selected), 'DSCP (0-63)' (Please Select), 'Flow Label (0-1048575)' (empty), and 'Time Range' (32 chars). 'Back' and 'Apply' buttons are at the bottom right.

Figure 8-70 Extended IPv6 ACL (Add Rule) Protocol ID window

The **dynamic** fields that can be configured are described below:

Parameter	Description
Protocol	Enter the Protocol ID value used here. This value must be between 0 and 255.
Fragments	Select the Fragments option to include packet fragment filtering.
Source	Select and enter the source information here. Options to choose from

	are Any , Host , and IPv6 . When the Any option is selected, any source traffic will be evaluated according to the conditions of this rule. When the Host option is selected, enter the source host's IPv6 address here. When the IPv6 option is selected, the Prefix Length option will also be available. Enter the source IPv6 address and prefix length value in the spaces provided.
Destination	Select and enter the destination information here. Options to choose from are Any , Host , and IPv6 . When the Any option is selected, any destination traffic will be evaluated according to the conditions of this rule. When the Host option is selected, enter the destination host's IPv6 address here. When the IPv6 option is selected, the Prefix Length option will also be available. Enter the destination IPv6 address and prefix length value in the spaces provided.
DSCP	Select or enter the DSCP value used here. This value must be between 0 and 63.
Flow Label	Enter the flow label value here. This value must be between 0 and 1048575.
Time Range	Enter the name of the time range to associate with this ACL rule.

After selecting the **ESP** option as the **Protocol Type**, the following page and parameters will be available, as shown below:

Figure 8-71 Extended IPv6 ACL (Add Rule) ESP window

The **dynamic** fields that can be configured are described below:

Parameter	Description
Fragments	Select the Fragments option to include packet fragment filtering.
Source	Select and enter the source information here. Options to choose from are Any , Host , and IPv6 . When the Any option is selected, any source traffic will be evaluated according to the conditions of this rule. When the Host option is selected, enter the source host's IPv6 address here. When the IPv6 option is selected, the Prefix Length option will also be available. Enter the source IPv6 address and prefix length value in the spaces provided.

Destination	Select and enter the destination information here. Options to choose from are Any , Host , and IPv6th . When the Any option is selected, any destination traffic will be evaluated according to the conditions of this rule. When the Host option is selected, enter the destination host's IPv6 address here. When the IPv6 option is selected, the Prefix Length option will also be available. Enter the destination IPv6 address and prefix length value in the spaces provided.
DSCP	Select or enter the DSCP value used here. This value must be between 0 and 63.
Flow Label	Enter the flow label value here. This value must be between 0 and 1048575.
Time Range	Enter the name of the time range to associate with this ACL rule.

After selecting the **PCP** option as the **Protocol Type**, the following page and parameters will be available, as shown below:

The screenshot shows the 'Add ACL Rule' window with the following configuration:

- ID:** 13000
- ACL Name:** Extendv6
- ACL Type:** Extended IPv6 ACL
- Sequence No. (1-65535):** (empty)
- Action:** Permit Deny
- Protocol Type:** PCP (dropdown), **108** (input), (0-255) range, Fragments
- Match IPv6 Address:**
 - Source:** Any, Host (2012::1), IPv6 (2012::1), Prefix Length (empty)
 - Destination:** Any, Host (2012::1), IPv6 (2012::1), Prefix Length (empty)
- DSCP (0-63):** Please Select (dropdown), (empty)
- Flow Label (0-1048575):** (empty)
- Time Range:** 32 chars (input)

Figure 8-72 Extend IPv6 ACL (Add Rule) PCP window

The **dynamic** fields that can be configured are described below:

Parameter	Description
Fragments	Select the Fragments option to include packet fragment filtering.
Source	Select and enter the source information here. Options to choose from are Any , Host , and IPv6 . When the Any option is selected, any source traffic will be evaluated according to the conditions of this rule. When the Host option is selected, enter the source host's IPv6 address here. When the IPv6 option is selected, the Prefix Length option will also be available. Enter the source IPv6 address and prefix length value in the spaces provided.
Destination	Select and enter the destination information here. Options to choose from are Any , Host , and IPv6 . When the Any option is selected, any destination traffic will be evaluated according to the conditions of this rule. When the Host option is selected, enter the destination host's IPv6 address here. When the IPv6 option is selected, the Prefix Length option will also be available. Enter the destination IPv6

	address and prefix length value in the spaces provided.
DSCP	Select or enter the DSCP value used here. This value must be between 0 and 63.
Flow Label	Enter the flow label value here. This value must be between 0 and 1048575.
Time Range	Enter the name of the time range to associate with this ACL rule.

After selecting the **SCTP** option as the **Protocol Type**, the following page and parameters will be available, as shown below:

The screenshot shows the 'Add ACL Rule' configuration window. The 'Protocol Type' is set to 'SCTP'. The 'Match IPv6 Address' section has radio buttons for 'Any', 'Host', and 'IPv6'. The 'Source' and 'Destination' fields are set to '2012::1'. The 'DSCP' field is set to 'Please Select'. The 'Flow Label' field is empty. The 'Time Range' field is set to '32 chars'. There are 'Back' and 'Apply' buttons at the bottom right.

Figure 8-73 Extended IPv6 ACL (Add Rule) SCTP window

The **dynamic** fields that can be configured are described below:

Parameter	Description
Fragments	Select the Fragments option to include packet fragment filtering.
Source	Select and enter the source information here. Options to choose from are Any , Host , and IPv6 . When the Any option is selected, any source traffic will be evaluated according to the conditions of this rule. When the Host option is selected, enter the source host's IPv6 address here. When the IPv6 option is selected, the Prefix Length option will also be available. Enter the source IPv6 address and prefix length value in the spaces provided.
Destination	Select and enter the destination information here. Options to choose from are Any , Host , and IPv6 . When the Any option is selected, any destination traffic will be evaluated according to the conditions of this rule. When the Host option is selected, enter the destination host's IPv6 address here. When the IPv6 option is selected, the Prefix Length option will also be available. Enter the destination IPv6 address and prefix length value in the spaces provided.
DSCP	Select or enter the DSCP value used here. This value must be between 0 and 63.
Flow Label	Enter the flow label value here. This value must be between 0 and 1048575.

Time Range	Enter the name of the time range to associate with this ACL rule.
-------------------	---

After selecting the **None** option as the **Protocol Type**, the following page and parameters will be available, as shown below:

The screenshot shows the 'Add ACL Rule' window for an Extended IPv6 ACL. The fields are as follows:

- ID:** 13000
- ACL Name:** Extendv6
- ACL Type:** Extended IPv6 ACL
- Sequence No. (1-65535):** (If it isn't specified, the system automatically assigns.)
- Action:** Permit Deny
- Protocol Type:** None (0-255) Fragments
- Match IPv6 Address:**
 - Source:** Any, Host (2012::1), IPv6 (2012::1) with Prefix Length.
 - Destination:** Any, Host (2012::1), IPv6 (2012::1) with Prefix Length.
- DSCP (0-63):** Please Select
- Flow Label (0-1048575):**
- Time Range:** 32 chars

Figure 8-74 Extended IPv6 ACL (Add Rule) None window

The **dynamic** fields that can be configured are described below:

Parameter	Description
Fragments	Select the Fragments option to include packet fragment filtering.
Source	Select and enter the source information here. Options to choose from are Any , Host , and IPv6 . When the Any option is selected, any source traffic will be evaluated according to the conditions of this rule. When the Host option is selected, enter the source host's IPv6 address here. When the IPv6 option is selected, the Prefix Length option will also be available. Enter the source IPv6 address and prefix length value in the spaces provided.
Destination	Select and enter the destination information here. Options to choose from are Any , Host , and IPv6 . When the Any option is selected, any destination traffic will be evaluated according to the conditions of this rule. When the Host option is selected, enter the destination host's IPv6 address here. When the IPv6 option is selected, the Prefix Length option will also be available. Enter the destination IPv6 address and prefix length value in the spaces provided.
DSCP	Select or enter the DSCP value used here. This value must be between 0 and 63.
Flow Label	Enter the flow label value here. This value must be between 0 and 1048575.
Time Range	Enter the name of the time range to associate with this ACL rule.

Click the **Back** button to discard the changes made and return to the previous page.

Click the **Apply** button to accept the changes made.

To enable the **Counter State** option or to enter a **Remark** for the profile, click the **Edit** button, next to the specific ACL profile (found in the ACL profile table).

The screenshot shows the 'ACL Access List' configuration window. At the top, there are options for 'ACL Type' (set to 'All'), 'ID (1-14999)' (with an input field), and 'ACL Name' (with a '32 chars' limit and a 'Find' button). Below this, it indicates 'Total Entries: 4' and an 'Add ACL' button. A table lists the ACL entries:

ID	ACL Name	ACL Type	Start Sequence No.	Step	Counter State	Remark	
1	StandardIP	Standard IP ACL	10	10	Enabled		Edit Delete
2000	ExtendIP	Extended IP ACL	10	10	Enabled		Edit Delete
11000	Standardv6	Standard IPv6 ACL	10	10	Enabled		Edit Delete
13000	Extendv6	Extended IPv6 ACL	10	10	Disabled		Apply Delete

Below the table, there are navigation buttons (1/1, <, <<, 1, >>, >) and a 'Go' button. Underneath, the 'Extendv6 (ID: 13000) Rule' section is visible, with buttons for 'Clear All Counter', 'Clear Counter', and 'Add Rule'. A table shows the rule details:

Sequence No.	Action	Rule	Time Range	Counter	
10	Permit	any any			Delete

Navigation buttons (1/1, <, <<, 1, >>, >) and a 'Go' button are also present at the bottom of the rule section.

Figure 8-75 Extended IPv6 ACL (Counter State Enabled) window

The fields that can be configured are described below:

Parameter	Description
Start Sequence No.	Enter the start sequence number here.
Stop	Enter the stop sequence number here.
Counter State	Select to enable or disable the counter state option here.
Remark	Enter an optional remark that will be associated with this profile here.

Click the **Apply** button to accept the changes made.

Click the **Delete** button to remove the specific entry.

To view the list of rules, that are associated with an ACL profile, select the ACL profile (found in the ACL profile table). The rule of ACL rules, connected to the selected ACL profile, will be displayed in the ACL rule table, as shown below:

The screenshot shows the 'ACL Access List' configuration window, similar to Figure 8-75. The 'ACL Type' is 'All', 'ID (1-14999)' is empty, and 'ACL Name' is '32 chars'. 'Total Entries: 4' is shown. The table lists the ACL entries:

ID	ACL Name	ACL Type	Start Sequence No.	Step	Counter State	Remark	
1	StandardIP	Standard IP ACL	10	10	Enabled		Edit Delete
2000	ExtendIP	Extended IP ACL	10	10	Enabled		Edit Delete
11000	Standardv6	Standard IPv6 ACL	10	10	Enabled		Edit Delete
13000	Extendv6	Extended IPv6 ACL	10	10	Enabled		Edit Delete

Navigation buttons (1/1, <, <<, 1, >>, >) and a 'Go' button are present. The 'Extendv6 (ID: 13000) Rule' section is visible, with buttons for 'Clear All Counter', 'Clear Counter', and 'Add Rule'. A table shows the rule details:

Sequence No.	Action	Rule	Time Range	Counter	
10	Permit	any any		(Ing: 0 packets)	Delete

Navigation buttons (1/1, <, <<, 1, >>, >) and a 'Go' button are also present at the bottom of the rule section.

Figure 8-76 Extended IPv6 ACL (Rule Display) window

Click the **Delete** button to remove the specific ACL rule.

Enter a page number and click the **Go** button to navigate to a specific page when multiple pages exist.

Extended MAC ACL

After clicking the **Add ACL** button, users can create a new ACL profile, as shown below:

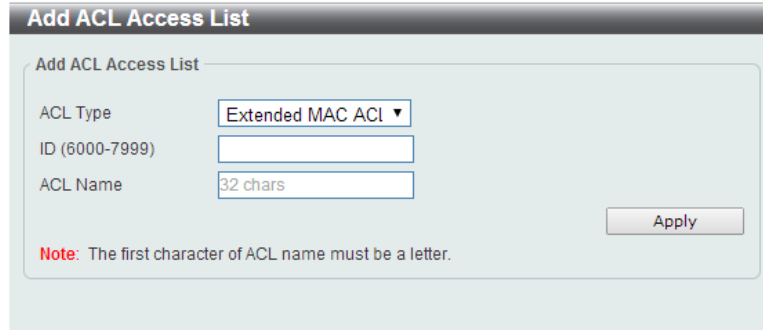

Figure 8-77 Extended MAC ACL (Add Profile) window

The fields that can be configured are described below:

Parameter	Description
ACL Type	Select the ACL profile type here. Options to choose from are Standard IP ACL , Extended IP ACL , Standard IPv6 ACL , Extended IPv6 ACL , Extended MAC ACL , and Extended Expert ACL .
ID	Enter the ACL ID from 6000 to 7999.
ACL Name	Enter the ACL profile's name here. This name can be up to 32 characters long.

Click the **Apply** button to create the new ACL profile.

After creating an Extend MAC ACL profile, the newly created Extend MAC ACL profile will be displayed in the ACL profile display table, as shown below:

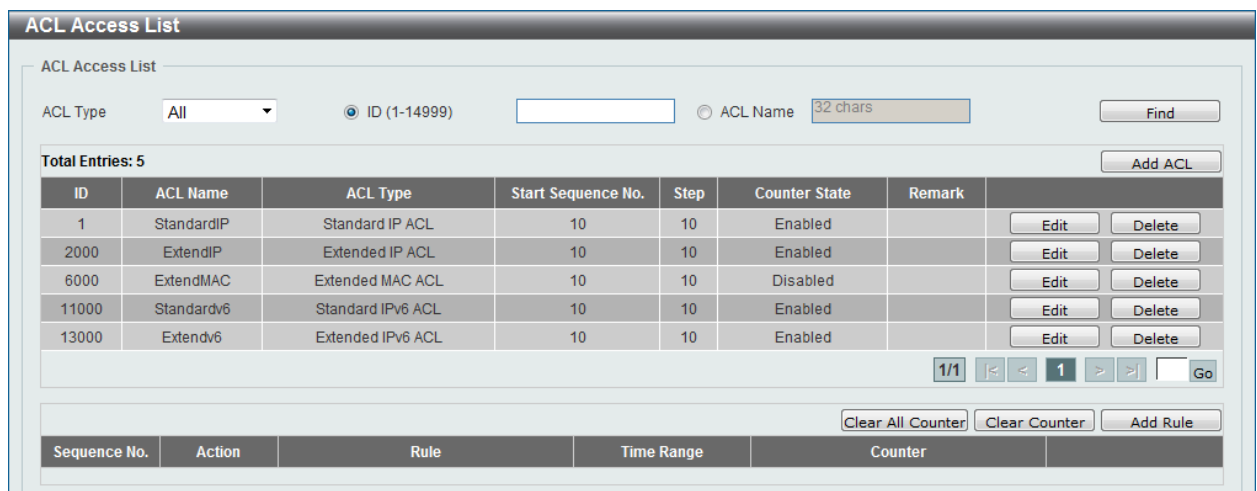

ID	ACL Name	ACL Type	Start Sequence No.	Step	Counter State	Remark	Edit	Delete
1	StandardIP	Standard IP ACL	10	10	Enabled		Edit	Delete
2000	ExtendIP	Extended IP ACL	10	10	Enabled		Edit	Delete
6000	ExtendMAC	Extended MAC ACL	10	10	Disabled		Edit	Delete
11000	Standardv6	Standard IPv6 ACL	10	10	Enabled		Edit	Delete
13000	Extendv6	Extended IPv6 ACL	10	10	Enabled		Edit	Delete

Figure 8-78 Extended MAC ACL (Main) window

Click the **Edit** button to re-configure the specific ACL profile.

Click the **Delete** button to remove the specific ACL profile.

Enter a page number and click the **Go** button to navigate to a specific page when multiple pages exist.

To add an ACL rule in the ACL profile, select it (the ACL profile will toggle to the bold font), and click the **Add Rule** button.

The screenshot shows the 'ACL Access List' window. At the top, there are search filters for 'ACL Type' (set to 'All') and 'ACL Name' (set to '32 chars'). Below this, a table lists 5 ACL entries. The entry with ID 6000, named 'ExtendMAC', is selected and bolded. Below the table, there are navigation buttons and a 'Go' button. At the bottom, the 'ExtendMAC (ID: 6000) Rule' configuration window is open, showing options to 'Clear All Counter', 'Clear Counter', and 'Add Rule'. The rule configuration table has columns for 'Sequence No.', 'Action', 'Rule', 'Time Range', and 'Counter'.

ID	ACL Name	ACL Type	Start Sequence No.	Step	Counter State	Remark	
1	StandardIP	Standard IP ACL	10	10	Enabled		Edit Delete
2000	ExtendIP	Extended IP ACL	10	10	Enabled		Edit Delete
6000	ExtendMAC	Extended MAC ACL	10	10	Disabled		Edit Delete
11000	Standardv6	Standard IPv6 ACL	10	10	Enabled		Edit Delete
13000	Extendv6	Extended IPv6 ACL	10	10	Enabled		Edit Delete

Figure 8-79 Extended MAC ACL (Selected) window

After selecting the ACL profile and clicking the **Add Rule** button, users can configure the new ACL rule, in the selected ACL profile, as shown below:

The screenshot shows the 'Add ACL Rule' window. It contains several configuration fields: 'ID' (6000), 'ACL Name' (ExtendMAC), 'ACL Type' (Extended MAC ACL), 'Sequence No.' (1-65535), 'Action' (Permit/Deny), 'Match MAC Address' (Source and Destination: Any/Host/MAC/Wildcard), 'Match Ethernet Type' (Specify Ethernet Type, Ethernet Type, Ethernet Type Mask), 'CoS' (Please Select), 'VID(1-4094)', and 'Time Range' (32 chars). 'Back' and 'Apply' buttons are at the bottom right.

Figure 8-80 Extended MAC ACL (Add Rule) window

The fields that can be configured are described below:

Parameter	Description
Rule Number	Enter the ACL rule number here. This value must be between 1 and 65535. If this value is not specified, the system will automatically

	generate an ACL rule number for this entry.
Action	Select the action that this rule will take here. Options to choose from are Permit and Deny .
Source	Select and enter the source information here. Options to choose from are Any , Host , and MAC . When the Any option is selected, any source traffic will be evaluated according to the conditions of this rule. When the Host option is selected, enter the source host's MAC address here. When the MAC option is selected, the Wildcard option will also be available. Enter the source MAC address and wildcard value in the spaces provided.
Destination	Select and enter the destination information here. Options to choose from are Any , Host , and MAC . When the Any option is selected, any destination traffic will be evaluated according to the conditions of this rule. When the Host option is selected, enter the destination host's MAC address here. When the MAC option is selected, the Wildcard option will also be available. Enter the destination MAC address and wildcard value in the spaces provided.
Specify Ethernet Type	Select the Ethernet type option here. Options to choose from are aarp , appletalk , decent-iv , etype-6000 , etype-8042 , lat , lavr-sca , mop-console , mop-dump , vines-echo , vines-ip , xns-idp , and arp .
Ethernet Type	Enter the Ethernet type hexadecimal value here. This value must be between 0x600 and 0xFFFF. When any Ethernet type profile is selected in the Specify Ethernet Type drop-down list, the appropriate hexadecimal value will automatically be entered.
Ethernet Type Mask	Enter the Ethernet type mask hexadecimal value here. This value must be between 0x0 and 0xFFFF. When any Ethernet type profile is selected in the Specify Ethernet Type drop-down list, the appropriate hexadecimal value will automatically be entered.
CoS	Select the CoS value used here. This value is between 0 and 7 .
Inner CoS	Select the inner CoS value used here. This value is between 0 and 7 .
VID	Enter the VLAN ID that will be associated with this ACL rule here. This value must be between 1 and 4094.
Time Range	Enter the name of the time range to associate with this ACL rule.

Click the **Back** button to discard the changes made and return to the previous page.

Click the **Apply** button to accept the changes made.

To enable the **Counter State** option or to enter a **Remark** for the profile, click the **Edit** button, next to the specific ACL profile (found in the ACL profile table).

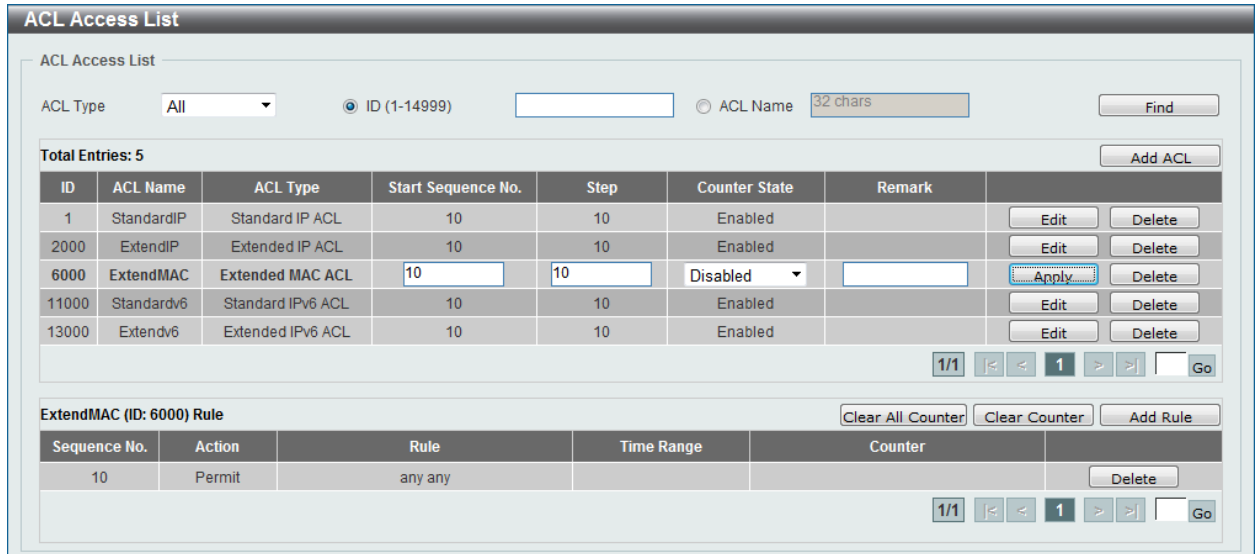

Figure 8-81 Extended MAC ACL (Edit ACL) window

The fields that can be configured are described below:

Parameter	Description
Start Sequence No.	Enter the start sequence number here.
Stop	Enter the stop sequence number here.
Counter State	Select to enable or disable the counter state option here.
Remark	Enter an optional remark that will be associated with this profile here.

Click the **Apply** button to accept the changes made.

Click the **Delete** button to remove the specific entry.

To view the list of rules, that are associated with an ACL profile, select the ACL profile (found in the ACL profile table). The rule of ACL rules, connected to the selected ACL profile, will be displayed in the ACL rule table, as shown below:

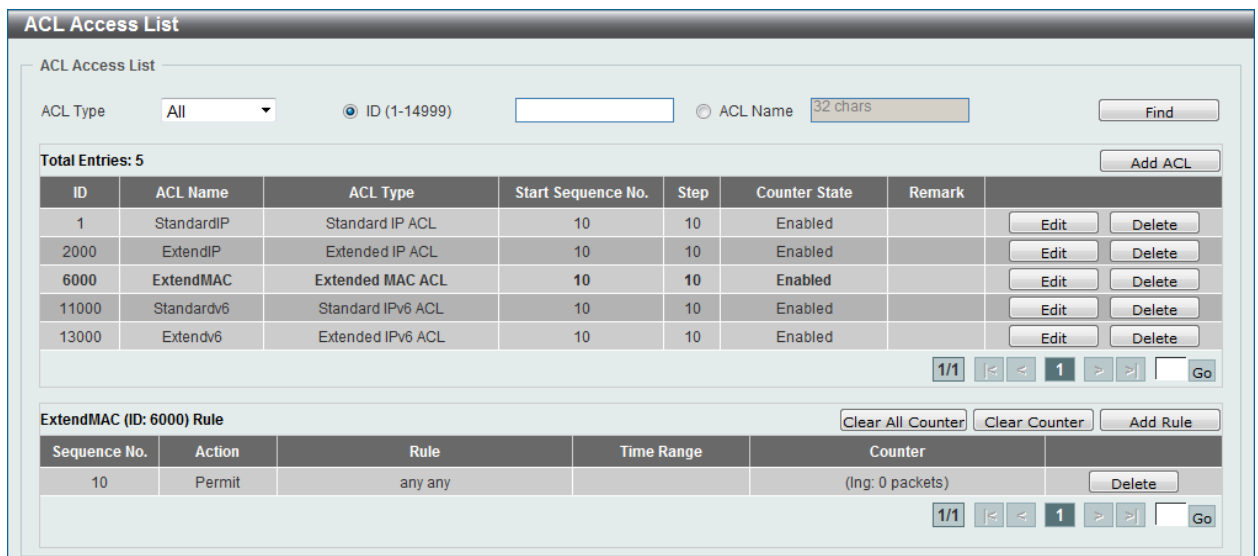

Figure 8-82 Extended MAC ACL (Rule Display) window

Click the **Delete** button to remove the specific ACL rule.

Enter a page number and click the **Go** button to navigate to a specific page when multiple pages exist.

Extended Expert ACL

After clicking the **Add ACL** button, users can create a new ACL profile, as shown below:

Figure 8-83 Extended Expert ACL (Add Profile) window

The fields that can be configured are described below:

Parameter	Description
ACL Type	Select the ACL profile type here. Options to choose from are Standard IP ACL , Extended IP ACL , Standard IPv6 ACL , Extended IPv6 ACL , Extended MAC ACL , and Extended Expert ACL .
ID	Enter the ACL ID from 8000 to 9999.
ACL Name	Enter the ACL profile's name here. This name can be up to 32 characters long.

Click the **Apply** button to create the new ACL profile.

After creating an Expert ACL profile, the newly created Expert ACL profile will be displayed in the ACL profile display table, as shown below:

Figure 8-84 Extended Expert ACL (Main) window

Click the **Edit** button to re-configure the specific ACL profile.

Click the **Delete** button to remove the specific ACL profile.

Enter a page number and click the **Go** button to navigate to a specific page when multiple pages exist.

To add an ACL rule in the ACL profile, select it (the ACL profile will toggle to the bold font), and click the **Add Rule** button.

The screenshot shows the 'ACL Access List' window. At the top, there are filters for 'ACL Type' (set to 'All') and 'ID (1-14999)'. Below the filters, a table lists 6 ACL entries. The entry with ID 8000 is selected and bolded. Below the table, there are navigation buttons and a 'Go' button. At the bottom, the 'ExtendExpert (ID: 8000) Rule' configuration window is open, showing fields for 'Sequence No.', 'Action', 'Rule', 'Time Range', and 'Counter'.

ID	ACL Name	ACL Type	Start Sequence No.	Step	Counter State	Remark	Edit	Delete
1	StandardIP	Standard IP ACL	10	10	Enabled		Edit	Delete
2000	ExtendIP	Extended IP ACL	10	10	Enabled		Edit	Delete
6000	ExtendMAC	Extended MAC ACL	10	10	Enabled		Edit	Delete
8000	ExtendExpe...	Extended Expert ACL	10	10	Disabled		Edit	Delete
11000	Standardv6	Standard IPv6 ACL	10	10	Enabled		Edit	Delete
13000	Extendv6	Extended IPv6 ACL	10	10	Enabled		Edit	Delete

Figure 8-85 Extended Expert ACL (Selected) window

After selecting the ACL profile and clicking the **Add Rule** button, users can configure the new ACL rule, in the selected ACL profile, as shown below:

The screenshot shows the 'Add ACL Rule' window. It contains various configuration fields:

- ID:** 8000
- ACL Name:** ExtendExpert
- ACL Type:** Extended Expert ACL
- Sequence No. (1-65535):** (empty field)
- Action:** Permit Deny
- Protocol Type:** TCP (dropdown), (0-255) (text), Fragments
- Match IP Address:** Source and Destination sections with radio buttons for Any, Host, IP, and Wildcard.
- Match MAC Address:** Source and Destination sections with radio buttons for Any, Host, MAC, and Wildcard.
- Match Port:** Source Port and Destination Port sections with dropdowns and text boxes.
- IP Precedence:** IP Precedence (Please Select) ToS (Please Select)
- DSCP (0-63):** DSCP (Please Select)
- TCP Flag:** ack fin psh rst syn urg
- VID(1-4094):** (empty text box)
- CoS:** Please Select (dropdown)
- Time Range:** 32 chars (text box)

 At the bottom right, there are 'Back' and 'Apply' buttons.

Figure 8-86 Extended Expert ACL (Add Rule) window

This is a dynamic page. Every selection made in the **Protocol Type** option will change the bottom part of this window.

The **fixed** fields that can be configured are described below:

Parameter	Description
Sequence No.	Enter the ACL rule number here. This value must be between 1 and 65535. If this value is not specified, the system will automatically generate an ACL rule number for this entry.
Action	Select the action that this rule will take here. Options to choose from are Permit and Deny .
Protocol Type	Select the protocol type option here. Options to choose from are TCP , UDP , ICMP , EIGRP , ESP , GRE , IGMP , OSPF , PIM , VRRP , IP-in-IP , PCP , Protocol ID , and None .

After selecting the **TCP** option as the **Protocol Type**, the following page and parameters will be available, as shown below:

The screenshot shows the 'Add ACL Rule' window with the following configuration:

- ID:** 8000
- ACL Name:** ExtendExpert
- ACL Type:** Extended Expert ACL
- Sequence No. (1-65535):** (empty)
- Action:** Permit Deny
- Protocol Type:** TCP
- Match IP Address:**
 - Source: Any, Host, IP, Wildcard: (empty)
 - Destination: Any, Host, IP, Wildcard: (empty)
- Match MAC Address:**
 - Source: Any, Host (11-DF-36-4B-A7-CC), MAC (11-DF-36-4B-A7-CC), Wildcard: (11-DF-36-4B-A7-CC)
 - Destination: Any, Host (11-DF-36-4B-A7-CC), MAC (11-DF-36-4B-A7-CC), Wildcard: (11-DF-36-4B-A7-CC)
- Match Port:**
 - Source Port: Please Select, (0-65535)
 - Destination Port: Please Select, (0-65535)
- IP Precedence:** Please Select, **ToS:** Please Select
- DSCP (0-63):** Please Select
- TCP Flag:** ack fin psh rst syn urg
- VID(1-4094):** (empty)
- CoS:** Please Select
- Time Range:** 32 chars

Figure 8-87 Extended Expert ACL (Add Rule) TCP window

The **dynamic** fields that can be configured are described below:

Parameter	Description
Source IP Address	Select and enter the source information here. Options to choose from

	are Any , Host , and IP . When the Any option is selected, any source traffic will be evaluated according to the conditions of this rule. When the Host option is selected, enter the source host's IP address here. When the IP option is selected, the Wildcard option will also be available. Enter the group of source IP addresses by using a wildcard bitmap. The bit corresponding to the bit value 1 will be ignored. The bit corresponding to the bit value 0 will be checked.
Destination IP Address	Select and enter the destination information here. Options to choose from are Any , Host , and IP . When the Any option is selected, any destination traffic will be evaluated according to the conditions of this rule. When the Host option is selected, enter the destination host's IP address here. When the IP option is selected, the Wildcard option will also be available. Enter the group of destination IP addresses by using a wildcard bitmap. The bit corresponding to the bit value 1 will be ignored. The bit corresponding to the bit value 0 will be checked.
Source MAC Address	Select and enter the source information here. Options to choose from are Any , Host , and MAC . When the Any option is selected, any source traffic will be evaluated according to the conditions of this rule. When the Host option is selected, enter the source host's MAC address here. When the MAC option is selected, the Wildcard option will also be available. Enter the source MAC address and wildcard value in the spaces provided.
Destination MAC Address	Select and enter the destination information here. Options to choose from are Any , Host , and MAC . When the Any option is selected, any destination traffic will be evaluated according to the conditions of this rule. When the Host option is selected, enter the destination host's MAC address here. When the MAC option is selected, the Wildcard option will also be available. Enter the destination MAC address and wildcard value in the spaces provided.
Source Port	Select and enter the source port value here. Options to choose from are = , > , < , ≠ , and Range . When selecting the = option, the specific selected port number will be used. When selecting the > option, all ports greater than the selected port, will be used. When selecting the < option, all ports smaller than the selected port, will be used. When selecting the ≠ option, all ports, excluding the selected port, will be used. When selecting the Range option, the start port number and end port number selected, of the range, will be used. Alternatively, the port number(s) can manually be entered in the space(s) provided, if the port number(s) is/are not available in the drop-down list.
Destination Port	Select and enter the destination port value here. Options to choose from are = , > , < , ≠ , and Range . When selecting the = option, the specific selected port number will be used. When selecting the > option, all ports greater than the selected port, will be used. When selecting the < option, all ports smaller than the selected port, will be used. When selecting the ≠ option, all ports, excluding the selected port, will be used. When selecting the Range option, the start port number and end port number selected, of the range, will be used. Alternatively, the port number(s) can manually be entered in the space(s) provided, if the port number(s) is/are not available in the drop-down list.
IP Precedence	Select the IP precedence value used here. Options to choose from are 0 (routine) , 1 (priority) , 2, (immediate) , 3 (flash) , 4 (flash-override) , 5 (critical) , 6 (internet) , and 7 (network) .
ToS	After selecting the IP precedence value, select the Type-of-Service (ToS) value that will be used here. Options to choose from are 0 (normal) , 1 (min-monetary-cost) , 2 (max-reliability) , 3, 4 (max-throughput) , 5, 6, 7, 8 (min-delay) , 9, 10, 11, 12, 13, 14 , and 15 .

DSCP	Select or enter the DSCP value used here. This value must be between 0 and 63.
TCP Flag	Tick the appropriate TCP flag option to include the flag in this rule. Options to choose from are ack , fin , psh , rst , syn , and urg .
VID	Enter the VLAN ID that will be associated with this ACL rule here. This value must be between 1 and 4094.
CoS	Select the Class of Service (CoS) value here. Options to choose from are from 0 to 7 .
Time Range	Enter the name of the time range to associate with this ACL rule.

After selecting the **UDP** option as the **Protocol Type**, the following page and parameters will be available, as shown below:

Figure 8-88 Extended Expert ACL (Add Rule) UDP window

The **dynamic** fields that can be configured are described below:

Parameter	Description
Source IP Address	Select and enter the source information here. Options to choose from are Any , Host , and IP . When the Any option is selected, any source traffic will be evaluated according to the conditions of this rule. When the Host option is selected, enter the source host's IP address here. When the IP option is selected, the Wildcard option will also be available. Enter the group of source IP addresses by using a wildcard bitmap. The bit corresponding to the bit value 1 will be ignored. The bit corresponding to the bit value 0 will be checked.

Destination IP Address	Select and enter the destination information here. Options to choose from are Any , Host , and IP . When the Any option is selected, any destination traffic will be evaluated according to the conditions of this rule. When the Host option is selected, enter the destination host's IP address here. When the IP option is selected, the Wildcard option will also be available. Enter the group of destination IP addresses by using a wildcard bitmap. The bit corresponding to the bit value 1 will be ignored. The bit corresponding to the bit value 0 will be checked.
Source MAC Address	Select and enter the source information here. Options to choose from are Any , Host , and MAC . When the Any option is selected, any source traffic will be evaluated according to the conditions of this rule. When the Host option is selected, enter the source host's MAC address here. When the MAC option is selected, the Wildcard option will also be available. Enter the source MAC address and wildcard value in the spaces provided.
Destination MAC Address	Select and enter the destination information here. Options to choose from are Any , Host , and MAC . When the Any option is selected, any destination traffic will be evaluated according to the conditions of this rule. When the Host option is selected, enter the destination host's MAC address here. When the MAC option is selected, the Wildcard option will also be available. Enter the destination MAC address and wildcard value in the spaces provided.
Source Port	Select and enter the source port value here. Options to choose from are = , > , < , ≠ , and Range . When selecting the = option, the specific selected port number will be used. When selecting the > option, all ports greater than the selected port, will be used. When selecting the < option, all ports smaller than the selected port, will be used. When selecting the ≠ option, all ports, excluding the selected port, will be used. When selecting the Range option, the start port number and end port number selected, of the range, will be used. Alternatively, the port number(s) can manually be entered in the space(s) provided, if the port number(s) is/are not available in the drop-down list.
Destination Port	Select and enter the destination port value here. Options to choose from are = , > , < , ≠ , and Range . When selecting the = option, the specific selected port number will be used. When selecting the > option, all ports greater than the selected port, will be used. When selecting the < option, all ports smaller than the selected port, will be used. When selecting the ≠ option, all ports, excluding the selected port, will be used. When selecting the Range option, the start port number and end port number selected, of the range, will be used. Alternatively, the port number(s) can manually be entered in the space(s) provided, if the port number(s) is/are not available in the drop-down list.
IP Precedence	Select the IP precedence value used here. Options to choose from are 0 (routine) , 1 (priority) , 2 (immediate) , 3 (flash) , 4 (flash-override) , 5 (critical) , 6 (internet) , and 7 (network) .
ToS	After selecting the IP precedence value, select the Type-of-Service (ToS) value that will be used here. Options to choose from are 0 (normal) , 1 (min-monetary-cost) , 2 (max-reliability) , 3, 4 (max-throughput) , 5, 6, 7, 8 (min-delay) , 9, 10, 11, 12, 13, 14 , and 15 .
DSCP	Select or enter the DSCP value used here. This value must be between 0 and 63.
VID	Enter the VLAN ID that will be associated with this ACL rule here. This value must be between 1 and 4094.
CoS	Select the Class of Service (CoS) value here. Options to choose from are from 0 to 7 .

Time Range	Enter the name of the time range to associate with this ACL rule.
-------------------	---

After selecting the **ICMP** option as the **Protocol Type**, the following page and parameters will be available, as shown below:

Figure 8-89 Extended Expert ACL (Add Rule) ICMP window

The **dynamic** fields that can be configured are described below:

Parameter	Description
Source IP Address	Select and enter the source information here. Options to choose from are Any , Host , and IP . When the Any option is selected, any source traffic will be evaluated according to the conditions of this rule. When the Host option is selected, enter the source host's IP address here. When the IP option is selected, the Wildcard option will also be available. Enter the group of source IP addresses by using a wildcard bitmap. The bit corresponding to the bit value 1 will be ignored. The bit corresponding to the bit value 0 will be checked.
Destination IP Address	Select and enter the destination information here. Options to choose from are Any , Host , and IP . When the Any option is selected, any destination traffic will be evaluated according to the conditions of this rule. When the Host option is selected, enter the destination host's IP address here. When the IP option is selected, the Wildcard option will also be available. Enter the group of destination IP addresses by using a wildcard bitmap. The bit corresponding to the bit value 1 will be ignored. The bit corresponding to the bit value 0 will be checked.
Source MAC Address	Select and enter the source information here. Options to choose from are Any , Host , and MAC . When the Any option is selected, any source traffic will be evaluated according to the conditions of this rule. When the Host option is selected, enter the source host's MAC

	address here. When the MAC option is selected, the Wildcard option will also be available. Enter the source MAC address and wildcard value in the spaces provided.
Destination MAC Address	Select and enter the destination information here. Options to choose from are Any , Host , and MAC . When the Any option is selected, any destination traffic will be evaluated according to the conditions of this rule. When the Host option is selected, enter the destination host's MAC address here. When the MAC option is selected, the Wildcard option will also be available. Enter the destination MAC address and wildcard value in the spaces provided.
Specify ICMP Message Type	Select the ICMP message type used here.
ICMP Message Type	When the ICMP Message Type is not selected in the Specify ICMP Message Type drop-down list, enter the ICMP Message Type numerical value used here. When the ICMP Message Type is selected in the Specify ICMP Message Type drop-down list, this numerical value will automatically be entered.
Message Code	When the ICMP Message Type is not selected in the Specify ICMP Message Type drop-down list, enter the Message Code numerical value used here. When the ICMP Message Type is selected in the Specify ICMP Message Type drop-down list, this numerical value will automatically be entered.
IP Precedence	Select the IP precedence value used here. Options to choose from are 0 (routine) , 1 (priority) , 2, (immediate) , 3 (flash) , 4 (flash-override) , 5 (critical) , 6 (internet) , and 7 (network) .
ToS	After selecting the IP precedence value, select the Type-of-Service (ToS) value that will be used here. Options to choose from are 0 (normal) , 1 (min-monetary-cost) , 2 (max-reliability) , 3, 4 (max-throughput) , 5, 6, 7, 8 (min-delay) , 9, 10, 11, 12, 13, 14, and 15 .
DSCP	Select or enter the DSCP value used here. This value must be between 0 and 63.
VID	Enter the VLAN ID that will be associated with this ACL rule here. This value must be between 1 and 4094.
CoS	Select the Class of Service (CoS) value here. Options to choose from are from 0 to 7 .
Time Range	Enter the name of the time range to associate with this ACL rule.

After selecting the **EIGRP** option as the **Protocol Type**, the following page and parameters will be available, as shown below:

Figure 8-90 Extended Expert ACL (Add Rule) EIGRP window

The **dynamic** fields that can be configured are described below:

Parameter	Description
Fragments	Select the Fragments option to include packet fragment filtering.
Source IP Address	Select and enter the source information here. Options to choose from are Any , Host , and IP . When the Any option is selected, any source traffic will be evaluated according to the conditions of this rule. When the Host option is selected, enter the source host's IP address here. When the IP option is selected, the Wildcard option will also be available. Enter the group of source IP addresses by using a wildcard bitmap. The bit corresponding to the bit value 1 will be ignored. The bit corresponding to the bit value 0 will be checked.
Destination IP Address	Select and enter the destination information here. Options to choose from are Any , Host , and IP . When the Any option is selected, any destination traffic will be evaluated according to the conditions of this rule. When the Host option is selected, enter the destination host's IP address here. When the IP option is selected, the Wildcard option will also be available. Enter the group of destination IP addresses by using a wildcard bitmap. The bit corresponding to the bit value 1 will be ignored. The bit corresponding to the bit value 0 will be checked.
Source MAC Address	Select and enter the source information here. Options to choose from are Any , Host , and MAC . When the Any option is selected, any source traffic will be evaluated according to the conditions of this rule. When the Host option is selected, enter the source host's MAC address here. When the MAC option is selected, the Wildcard option will also be available. Enter the source MAC address and wildcard value in the spaces provided.
Destination MAC Address	Select and enter the destination information here. Options to choose

	from are Any , Host , and MAC . When the Any option is selected, any destination traffic will be evaluated according to the conditions of this rule. When the Host option is selected, enter the destination host's MAC address here. When the MAC option is selected, the Wildcard option will also be available. Enter the destination MAC address and wildcard value in the spaces provided.
IP Precedence	Select the IP precedence value used here. Options to choose from are 0 (routine) , 1 (priority) , 2, (immediate) , 3 (flash) , 4 (flash-override) , 5 (critical) , 6 (internet) , and 7 (network) .
ToS	After selecting the IP precedence value, select the Type-of-Service (ToS) value that will be used here. Options to choose from are 0 (normal) , 1 (min-monetary-cost) , 2 (max-reliability) , 3, 4 (max-throughput) , 5, 6, 7, 8 (min-delay) , 9, 10, 11, 12, 13, 14 , and 15 .
DSCP	Select or enter the DSCP value used here. This value must be between 0 and 63.
VID	Enter the VLAN ID that will be associated with this ACL rule here. This value must be between 1 and 4094.
CoS	Select the Class of Service (CoS) value here. Options to choose from are from 0 to 7 .
Time Range	Enter the name of the time range to associate with this ACL rule.

After selecting the **ESP** option as the **Protocol Type**, the following page and parameters will be available, as shown below:

Figure 8-91 Extended Expert ACL (Add Rule) ESP window

The **dynamic** fields that can be configured are described below:

Parameter	Description
Fragments	Select the Fragments option to include packet fragment filtering.

Source IP Address	Select and enter the source information here. Options to choose from are Any , Host , and IP . When the Any option is selected, any source traffic will be evaluated according to the conditions of this rule. When the Host option is selected, enter the source host's IP address here. When the IP option is selected, the Wildcard option will also be available. Enter the group of source IP addresses by using a wildcard bitmap. The bit corresponding to the bit value 1 will be ignored. The bit corresponding to the bit value 0 will be checked.
Destination IP Address	Select and enter the destination information here. Options to choose from are Any , Host , and IP . When the Any option is selected, any destination traffic will be evaluated according to the conditions of this rule. When the Host option is selected, enter the destination host's IP address here. When the IP option is selected, the Wildcard option will also be available. Enter the group of destination IP addresses by using a wildcard bitmap. The bit corresponding to the bit value 1 will be ignored. The bit corresponding to the bit value 0 will be checked.
Source MAC Address	Select and enter the source information here. Options to choose from are Any , Host , and MAC . When the Any option is selected, any source traffic will be evaluated according to the conditions of this rule. When the Host option is selected, enter the source host's MAC address here. When the MAC option is selected, the Wildcard option will also be available. Enter the source MAC address and wildcard value in the spaces provided.
Destination MAC Address	Select and enter the destination information here. Options to choose from are Any , Host , and MAC . When the Any option is selected, any destination traffic will be evaluated according to the conditions of this rule. When the Host option is selected, enter the destination host's MAC address here. When the MAC option is selected, the Wildcard option will also be available. Enter the destination MAC address and wildcard value in the spaces provided.
IP Precedence	Select the IP precedence value used here. Options to choose from are 0 (routine) , 1 (priority) , 2 (immediate) , 3 (flash) , 4 (flash-override) , 5 (critical) , 6 (internet) , and 7 (network) .
ToS	After selecting the IP precedence value, select the Type-of-Service (ToS) value that will be used here. Options to choose from are 0 (normal) , 1 (min-monetary-cost) , 2 (max-reliability) , 3, 4 (max-throughput) , 5, 6, 7, 8 (min-delay) , 9, 10, 11, 12, 13, 14 , and 15 .
DSCP	Select or enter the DSCP value used here. This value must be between 0 and 63.
VID	Enter the VLAN ID that will be associated with this ACL rule here. This value must be between 1 and 4094.
CoS	Select the Class of Service (CoS) value here. Options to choose from are from 0 to 7 .
Time Range	Enter the name of the time range to associate with this ACL rule.

After selecting the **GRE** option as the **Protocol Type**, the following page and parameters will be available, as shown below:

Figure 8-92 Extended Expert ACL (Add Rule) GRE window

The **dynamic** fields that can be configured are described below:

Parameter	Description
Fragments	Select the Fragments option to include packet fragment filtering.
Source IP Address	Select and enter the source information here. Options to choose from are Any , Host , and IP . When the Any option is selected, any source traffic will be evaluated according to the conditions of this rule. When the Host option is selected, enter the source host's IP address here. When the IP option is selected, the Wildcard option will also be available. Enter the group of source IP addresses by using a wildcard bitmap. The bit corresponding to the bit value 1 will be ignored. The bit corresponding to the bit value 0 will be checked.
Destination IP Address	Select and enter the destination information here. Options to choose from are Any , Host , and IP . When the Any option is selected, any destination traffic will be evaluated according to the conditions of this rule. When the Host option is selected, enter the destination host's IP address here. When the IP option is selected, the Wildcard option will also be available. Enter the group of destination IP addresses by using a wildcard bitmap. The bit corresponding to the bit value 1 will be ignored. The bit corresponding to the bit value 0 will be checked.
Source MAC Address	Select and enter the source information here. Options to choose from are Any , Host , and MAC . When the Any option is selected, any source traffic will be evaluated according to the conditions of this rule. When the Host option is selected, enter the source host's MAC address here. When the MAC option is selected, the Wildcard option will also be available. Enter the source MAC address and wildcard value in the spaces provided.
Destination MAC Address	Select and enter the destination information here. Options to choose

	from are Any , Host , and MAC . When the Any option is selected, any destination traffic will be evaluated according to the conditions of this rule. When the Host option is selected, enter the destination host's MAC address here. When the MAC option is selected, the Wildcard option will also be available. Enter the destination MAC address and wildcard value in the spaces provided.
IP Precedence	Select the IP precedence value used here. Options to choose from are 0 (routine) , 1 (priority) , 2, (immediate) , 3 (flash) , 4 (flash-override) , 5 (critical) , 6 (internet) , and 7 (network) .
ToS	After selecting the IP precedence value, select the Type-of-Service (ToS) value that will be used here. Options to choose from are 0 (normal) , 1 (min-monetary-cost) , 2 (max-reliability) , 3, 4 (max-throughput) , 5, 6, 7, 8 (min-delay) , 9, 10, 11, 12, 13, 14 , and 15 .
DSCP	Select or enter the DSCP value used here. This value must be between 0 and 63.
VID	Enter the VLAN ID that will be associated with this ACL rule here. This value must be between 1 and 4094.
CoS	Select the Class of Service (CoS) value here. Options to choose from are from 0 to 7 .
Time Range	Enter the name of the time range to associate with this ACL rule.

After selecting the **IGMP** option as the **Protocol Type**, the following page and parameters will be available, as shown below:

Figure 8-93 Extended Expert ACL (Add Rule) IGMP window

The **dynamic** fields that can be configured are described below:

Parameter	Description
Fragments	Select the Fragments option to include packet fragment filtering.

Source IP Address	Select and enter the source information here. Options to choose from are Any , Host , and IP . When the Any option is selected, any source traffic will be evaluated according to the conditions of this rule. When the Host option is selected, enter the source host's IP address here. When the IP option is selected, the Wildcard option will also be available. Enter the group of source IP addresses by using a wildcard bitmap. The bit corresponding to the bit value 1 will be ignored. The bit corresponding to the bit value 0 will be checked.
Destination IP Address	Select and enter the destination information here. Options to choose from are Any , Host , and IP . When the Any option is selected, any destination traffic will be evaluated according to the conditions of this rule. When the Host option is selected, enter the destination host's IP address here. When the IP option is selected, the Wildcard option will also be available. Enter the group of destination IP addresses by using a wildcard bitmap. The bit corresponding to the bit value 1 will be ignored. The bit corresponding to the bit value 0 will be checked.
Source MAC Address	Select and enter the source information here. Options to choose from are Any , Host , and MAC . When the Any option is selected, any source traffic will be evaluated according to the conditions of this rule. When the Host option is selected, enter the source host's MAC address here. When the MAC option is selected, the Wildcard option will also be available. Enter the source MAC address and wildcard value in the spaces provided.
Destination MAC Address	Select and enter the destination information here. Options to choose from are Any , Host , and MAC . When the Any option is selected, any destination traffic will be evaluated according to the conditions of this rule. When the Host option is selected, enter the destination host's MAC address here. When the MAC option is selected, the Wildcard option will also be available. Enter the destination MAC address and wildcard value in the spaces provided.
IP Precedence	Select the IP precedence value used here. Options to choose from are 0 (routine) , 1 (priority) , 2 (immediate) , 3 (flash) , 4 (flash-override) , 5 (critical) , 6 (internet) , and 7 (network) .
ToS	After selecting the IP precedence value, select the Type-of-Service (ToS) value that will be used here. Options to choose from are 0 (normal) , 1 (min-monetary-cost) , 2 (max-reliability) , 3, 4 (max-throughput) , 5, 6, 7, 8 (min-delay) , 9, 10, 11, 12, 13, 14 , and 15 .
DSCP	Select or enter the DSCP value used here. This value must be between 0 and 63.
VID	Enter the VLAN ID that will be associated with this ACL rule here. This value must be between 1 and 4094.
CoS	Select the Class of Service (CoS) value here. Options to choose from are from 0 to 7 .
Time Range	Enter the name of the time range to associate with this ACL rule.

After selecting the **OSPF** option as the **Protocol Type**, the following page and parameters will be available, as shown below:

Figure 8-94 Extended Expert ACL (Add Rule) OSPF window

The **dynamic** fields that can be configured are described below:

Parameter	Description
Fragments	Select the Fragments option to include packet fragment filtering.
Source IP Address	Select and enter the source information here. Options to choose from are Any , Host , and IP . When the Any option is selected, any source traffic will be evaluated according to the conditions of this rule. When the Host option is selected, enter the source host's IP address here. When the IP option is selected, the Wildcard option will also be available. Enter the group of source IP addresses by using a wildcard bitmap. The bit corresponding to the bit value 1 will be ignored. The bit corresponding to the bit value 0 will be checked.
Destination IP Address	Select and enter the destination information here. Options to choose from are Any , Host , and IP . When the Any option is selected, any destination traffic will be evaluated according to the conditions of this rule. When the Host option is selected, enter the destination host's IP address here. When the IP option is selected, the Wildcard option will also be available. Enter the group of destination IP addresses by using a wildcard bitmap. The bit corresponding to the bit value 1 will be ignored. The bit corresponding to the bit value 0 will be checked.
Source MAC Address	Select and enter the source information here. Options to choose from are Any , Host , and MAC . When the Any option is selected, any source traffic will be evaluated according to the conditions of this rule. When the Host option is selected, enter the source host's MAC address here. When the MAC option is selected, the Wildcard option will also be available. Enter the source MAC address and wildcard value in the spaces provided.
Destination MAC Address	Select and enter the destination information here. Options to choose

	from are Any , Host , and MAC . When the Any option is selected, any destination traffic will be evaluated according to the conditions of this rule. When the Host option is selected, enter the destination host's MAC address here. When the MAC option is selected, the Wildcard option will also be available. Enter the destination MAC address and wildcard value in the spaces provided.
IP Precedence	Select the IP precedence value used here. Options to choose from are 0 (routine) , 1 (priority) , 2, (immediate) , 3 (flash) , 4 (flash-override) , 5 (critical) , 6 (internet) , and 7 (network) .
ToS	After selecting the IP precedence value, select the Type-of-Service (ToS) value that will be used here. Options to choose from are 0 (normal) , 1 (min-monetary-cost) , 2 (max-reliability) , 3, 4 (max-throughput) , 5, 6, 7, 8 (min-delay) , 9, 10, 11, 12, 13, 14 , and 15 .
DSCP	Select or enter the DSCP value used here. This value must be between 0 and 63.
VID	Enter the VLAN ID that will be associated with this ACL rule here. This value must be between 1 and 4094.
CoS	Select the Class of Service (CoS) value here. Options to choose from are from 0 to 7 .
Time Range	Enter the name of the time range to associate with this ACL rule.

After selecting the **PIM** option as the **Protocol Type**, the following page and parameters will be available, as shown below:

Figure 8-95 Extended Expert ACL (Add Rule) PIM window

The **dynamic** fields that can be configured are described below:

Parameter	Description
Fragments	Select the Fragments option to include packet fragment filtering.

Source IP Address	Select and enter the source information here. Options to choose from are Any , Host , and IP . When the Any option is selected, any source traffic will be evaluated according to the conditions of this rule. When the Host option is selected, enter the source host's IP address here. When the IP option is selected, the Wildcard option will also be available. Enter the group of source IP addresses by using a wildcard bitmap. The bit corresponding to the bit value 1 will be ignored. The bit corresponding to the bit value 0 will be checked.
Destination IP Address	Select and enter the destination information here. Options to choose from are Any , Host , and IP . When the Any option is selected, any destination traffic will be evaluated according to the conditions of this rule. When the Host option is selected, enter the destination host's IP address here. When the IP option is selected, the Wildcard option will also be available. Enter the group of destination IP addresses by using a wildcard bitmap. The bit corresponding to the bit value 1 will be ignored. The bit corresponding to the bit value 0 will be checked.
Source MAC Address	Select and enter the source information here. Options to choose from are Any , Host , and MAC . When the Any option is selected, any source traffic will be evaluated according to the conditions of this rule. When the Host option is selected, enter the source host's MAC address here. When the MAC option is selected, the Wildcard option will also be available. Enter the source MAC address and wildcard value in the spaces provided.
Destination MAC Address	Select and enter the destination information here. Options to choose from are Any , Host , and MAC . When the Any option is selected, any destination traffic will be evaluated according to the conditions of this rule. When the Host option is selected, enter the destination host's MAC address here. When the MAC option is selected, the Wildcard option will also be available. Enter the destination MAC address and wildcard value in the spaces provided.
IP Precedence	Select the IP precedence value used here. Options to choose from are 0 (routine) , 1 (priority) , 2 (immediate) , 3 (flash) , 4 (flash-override) , 5 (critical) , 6 (internet) , and 7 (network) .
ToS	After selecting the IP precedence value, select the Type-of-Service (ToS) value that will be used here. Options to choose from are 0 (normal) , 1 (min-monetary-cost) , 2 (max-reliability) , 3, 4 (max-throughput) , 5, 6, 7, 8 (min-delay) , 9, 10, 11, 12, 13, 14 , and 15 .
DSCP	Select or enter the DSCP value used here. This value must be between 0 and 63.
VID	Enter the VLAN ID that will be associated with this ACL rule here. This value must be between 1 and 4094.
CoS	Select the Class of Service (CoS) value here. Options to choose from are from 0 to 7 .
Time Range	Enter the name of the time range to associate with this ACL rule.

After selecting the **VRRP** option as the **Protocol Type**, the following page and parameters will be available, as shown below:

Figure 8-96 Extended Expert ACL (Add Rule) VRRP window

The **dynamic** fields that can be configured are described below:

Parameter	Description
Fragments	Select the Fragments option to include packet fragment filtering.
Source IP Address	Select and enter the source information here. Options to choose from are Any , Host , and IP . When the Any option is selected, any source traffic will be evaluated according to the conditions of this rule. When the Host option is selected, enter the source host's IP address here. When the IP option is selected, the Wildcard option will also be available. Enter the group of source IP addresses by using a wildcard bitmap. The bit corresponding to the bit value 1 will be ignored. The bit corresponding to the bit value 0 will be checked.
Destination IP Address	Select and enter the destination information here. Options to choose from are Any , Host , and IP . When the Any option is selected, any destination traffic will be evaluated according to the conditions of this rule. When the Host option is selected, enter the destination host's IP address here. When the IP option is selected, the Wildcard option will also be available. Enter the group of destination IP addresses by using a wildcard bitmap. The bit corresponding to the bit value 1 will be ignored. The bit corresponding to the bit value 0 will be checked.
Source MAC Address	Select and enter the source information here. Options to choose from are Any , Host , and MAC . When the Any option is selected, any source traffic will be evaluated according to the conditions of this rule. When the Host option is selected, enter the source host's MAC address here. When the MAC option is selected, the Wildcard option will also be available. Enter the source MAC address and wildcard value in the spaces provided.
Destination MAC Address	Select and enter the destination information here. Options to choose from are Any , Host , and MAC . When the Any option is selected, any

	destination traffic will be evaluated according to the conditions of this rule. When the Host option is selected, enter the destination host's MAC address here. When the MAC option is selected, the Wildcard option will also be available. Enter the destination MAC address and wildcard value in the spaces provided.
IP Precedence	Select the IP precedence value used here. Options to choose from are 0 (routine) , 1 (priority) , 2 (immediate) , 3 (flash) , 4 (flash-override) , 5 (critical) , 6 (internet) , and 7 (network) .
ToS	After selecting the IP precedence value, select the Type-of-Service (ToS) value that will be used here. Options to choose from are 0 (normal) , 1 (min-monetary-cost) , 2 (max-reliability) , 3, 4 (max-throughput) , 5, 6, 7, 8 (min-delay) , 9, 10, 11, 12, 13, 14 , and 15 .
DSCP	Select or enter the DSCP value used here. This value must be between 0 and 63.
VID	Enter the VLAN ID that will be associated with this ACL rule here. This value must be between 1 and 4094.
CoS	Select the Class of Service (CoS) value here. Options to choose from are from 0 to 7 .
Time Range	Enter the name of the time range to associate with this ACL rule.

After selecting the **IP-in-IP** option as the **Protocol Type**, the following page and parameters will be available, as shown below:

The screenshot shows the 'Add ACL Rule' configuration window. Key parameters are: ID: 8000, ACL Name: ExtendExpert, ACL Type: Extended Expert ACL, Sequence No.: (empty), Action: Permit, Protocol Type: IP-in-IP, Match IP Address: Source (Any), Destination (Any), Match MAC Address: Source (Any), Destination (Any), IP Precedence: Please Select, ToS: Please Select, DSCP: Please Select, VID: (empty), CoS: Please Select, Time Range: 32 chars. Buttons for 'Back' and 'Apply' are visible at the bottom right.

Figure 8-97 Extended Expert ACL (Add Rule) IP-in-IP window

The **dynamic** fields that can be configured are described below:

Parameter	Description
Fragments	Select the Fragments option to include packet fragment filtering.
Source IP Address	Select and enter the source information here. Options to choose from

	are Any , Host , and IP . When the Any option is selected, any source traffic will be evaluated according to the conditions of this rule. When the Host option is selected, enter the source host's IP address here. When the IP option is selected, the Wildcard option will also be available. Enter the group of source IP addresses by using a wildcard bitmap. The bit corresponding to the bit value 1 will be ignored. The bit corresponding to the bit value 0 will be checked.
Destination IP Address	Select and enter the destination information here. Options to choose from are Any , Host , and IP . When the Any option is selected, any destination traffic will be evaluated according to the conditions of this rule. When the Host option is selected, enter the destination host's IP address here. When the IP option is selected, the Wildcard option will also be available. Enter the group of destination IP addresses by using a wildcard bitmap. The bit corresponding to the bit value 1 will be ignored. The bit corresponding to the bit value 0 will be checked.
Source MAC Address	Select and enter the source information here. Options to choose from are Any , Host , and MAC . When the Any option is selected, any source traffic will be evaluated according to the conditions of this rule. When the Host option is selected, enter the source host's MAC address here. When the MAC option is selected, the Wildcard option will also be available. Enter the source MAC address and wildcard value in the spaces provided.
Destination MAC Address	Select and enter the destination information here. Options to choose from are Any , Host , and MAC . When the Any option is selected, any destination traffic will be evaluated according to the conditions of this rule. When the Host option is selected, enter the destination host's MAC address here. When the MAC option is selected, the Wildcard option will also be available. Enter the destination MAC address and wildcard value in the spaces provided.
IP Precedence	Select the IP precedence value used here. Options to choose from are 0 (routine) , 1 (priority) , 2 (immediate) , 3 (flash) , 4 (flash-override) , 5 (critical) , 6 (internet) , and 7 (network) .
ToS	After selecting the IP precedence value, select the Type-of-Service (ToS) value that will be used here. Options to choose from are 0 (normal) , 1 (min-monetary-cost) , 2 (max-reliability) , 3, 4 (max-throughput) , 5, 6, 7, 8 (min-delay) , 9, 10, 11, 12, 13, 14, and 15 .
DSCP	Select or enter the DSCP value used here. This value must be between 0 and 63.
VID	Enter the VLAN ID that will be associated with this ACL rule here. This value must be between 1 and 4094.
CoS	Select the Class of Service (CoS) value here. Options to choose from are from 0 to 7 .
Time Range	Enter the name of the time range to associate with this ACL rule.

After selecting the **PCP** option as the **Protocol Type**, the following page and parameters will be available, as shown below:

The screenshot shows the 'Add ACL Rule' configuration window. The 'ID' is 8000, 'ACL Name' is 'ExtendExpert', and 'ACL Type' is 'Extended Expert ACL'. The 'Action' is set to 'Permit'. The 'Protocol Type' is 'PCP' with a value of '108'. The 'Match IP Address' section has 'Source' and 'Destination' both set to 'Any'. The 'Match MAC Address' section has 'Source' and 'Destination' both set to 'Any' with a MAC address of '11-DF-36-4B-A7-CC'. There are also fields for 'IP Precedence', 'DSCP', 'ToS', 'CoS', 'VID', and 'Time Range'.

Figure 8-98 Extended Expert ACL (Add Rule) PCP window

The **dynamic** fields that can be configured are described below:

Parameter	Description
Fragments	Select the Fragments option to include packet fragment filtering.
Source IP Address	Select and enter the source information here. Options to choose from are Any , Host , and IP . When the Any option is selected, any source traffic will be evaluated according to the conditions of this rule. When the Host option is selected, enter the source host's IP address here. When the IP option is selected, the Wildcard option will also be available. Enter the group of source IP addresses by using a wildcard bitmap. The bit corresponding to the bit value 1 will be ignored. The bit corresponding to the bit value 0 will be checked.
Destination IP Address	Select and enter the destination information here. Options to choose from are Any , Host , and IP . When the Any option is selected, any destination traffic will be evaluated according to the conditions of this rule. When the Host option is selected, enter the destination host's IP address here. When the IP option is selected, the Wildcard option will also be available. Enter the group of destination IP addresses by using a wildcard bitmap. The bit corresponding to the bit value 1 will be ignored. The bit corresponding to the bit value 0 will be checked.
Source MAC Address	Select and enter the source information here. Options to choose from are Any , Host , and MAC . When the Any option is selected, any source traffic will be evaluated according to the conditions of this rule. When the Host option is selected, enter the source host's MAC address here. When the MAC option is selected, the Wildcard option will also be available. Enter the source MAC address and wildcard value in the spaces provided.
Destination MAC Address	Select and enter the destination information here. Options to choose from are Any , Host , and MAC . When the Any option is selected, any destination traffic will be evaluated according to the conditions of this rule. When the Host option is selected, enter the destination host's

	MAC address here. When the MAC option is selected, the Wildcard option will also be available. Enter the destination MAC address and wildcard value in the spaces provided.
IP Precedence	Select the IP precedence value used here. Options to choose from are 0 (routine) , 1 (priority) , 2, (immediate) , 3 (flash) , 4 (flash-override) , 5 (critical) , 6 (internet) , and 7 (network) .
ToS	After selecting the IP precedence value, select the Type-of-Service (ToS) value that will be used here. Options to choose from are 0 (normal) , 1 (min-monetary-cost) , 2 (max-reliability) , 3, 4 (max-throughput) , 5, 6, 7, 8 (min-delay) , 9, 10, 11, 12, 13, 14 , and 15 .
DSCP	Select or enter the DSCP value used here. This value must be between 0 and 63.
VID	Enter the VLAN ID that will be associated with this ACL rule here. This value must be between 1 and 4094.
CoS	Select the Class of Service (CoS) value here. Options to choose from are from 0 to 7 .
Time Range	Enter the name of the time range to associate with this ACL rule.

After selecting the **Protocol ID** option as the **Protocol Type**, the following page and parameters will be available, as shown below:

The screenshot shows the 'Add ACL Rule' window with the following configuration details:

- ID:** 8000
- ACL Name:** ExtendExpert
- ACL Type:** Extended Expert ACL
- Sequence No. (1-65535):** [Empty field] (If it isn't specified, the system automatically assigns.)
- Action:** Permit Deny
- Protocol Type:** Protocol ID [Empty field] (0-255) Fragments
- Match IP Address:**
 - Source:** Any, Host, IP, Wildcard [Empty field]
 - Destination:** Any, Host, IP, Wildcard [Empty field]
- Match MAC Address:**
 - Source:** Any, Host (11-DF-36-4B-A7-CC), MAC (11-DF-36-4B-A7-CC), Wildcard (11-DF-36-4B-A7-CC)
 - Destination:** Any, Host (11-DF-36-4B-A7-CC), MAC (11-DF-36-4B-A7-CC), Wildcard (11-DF-36-4B-A7-CC)
- IP Precedence:** Please Select (dropdown), **ToS:** Please Select (dropdown)
- DSCP (0-63):** Please Select (dropdown), [Empty field]
- VID(1-4094):** [Empty field]
- CoS:** Please Select (dropdown)
- Time Range:** 32 chars (text field)
- Buttons:** Back, Apply

Figure 8-99 Extended Expert ACL (Add Rule) Protocol ID window

The **dynamic** fields that can be configured are described below:

Parameter	Description
Protocol	Enter the Protocol ID value used here. This value must be between 0 and 255.
Fragments	Select the Fragments option to include packet fragment filtering.

Source IP Address	Select and enter the source information here. Options to choose from are Any , Host , and IP . When the Any option is selected, any source traffic will be evaluated according to the conditions of this rule. When the Host option is selected, enter the source host's IP address here. When the IP option is selected, the Wildcard option will also be available. Enter the group of source IP addresses by using a wildcard bitmap. The bit corresponding to the bit value 1 will be ignored. The bit corresponding to the bit value 0 will be checked.
Destination IP Address	Select and enter the destination information here. Options to choose from are Any , Host , and IP . When the Any option is selected, any destination traffic will be evaluated according to the conditions of this rule. When the Host option is selected, enter the destination host's IP address here. When the IP option is selected, the Wildcard option will also be available. Enter the group of destination IP addresses by using a wildcard bitmap. The bit corresponding to the bit value 1 will be ignored. The bit corresponding to the bit value 0 will be checked.
Source MAC Address	Select and enter the source information here. Options to choose from are Any , Host , and MAC . When the Any option is selected, any source traffic will be evaluated according to the conditions of this rule. When the Host option is selected, enter the source host's MAC address here. When the MAC option is selected, the Wildcard option will also be available. Enter the source MAC address and wildcard value in the spaces provided.
Destination MAC Address	Select and enter the destination information here. Options to choose from are Any , Host , and MAC . When the Any option is selected, any destination traffic will be evaluated according to the conditions of this rule. When the Host option is selected, enter the destination host's MAC address here. When the MAC option is selected, the Wildcard option will also be available. Enter the destination MAC address and wildcard value in the spaces provided.
IP Precedence	Select the IP precedence value used here. Options to choose from are 0 (routine) , 1 (priority) , 2 (immediate) , 3 (flash) , 4 (flash-override) , 5 (critical) , 6 (internet) , and 7 (network) .
ToS	After selecting the IP precedence value, select the Type-of-Service (ToS) value that will be used here. Options to choose from are 0 (normal) , 1 (min-monetary-cost) , 2 (max-reliability) , 3, 4 (max-throughput) , 5, 6, 7, 8 (min-delay) , 9, 10, 11, 12, 13, 14 , and 15 .
DSCP	Select or enter the DSCP value used here. This value must be between 0 and 63.
VID	Enter the VLAN ID that will be associated with this ACL rule here. This value must be between 1 and 4094.
CoS	Select the Class of Service (CoS) value here. Options to choose from are from 0 to 7 .
Time Range	Enter the name of the time range to associate with this ACL rule.

After selecting the **None** option as the **Protocol Type**, the following page and parameters will be available, as shown below:

Figure 8-100 Extended Expert ACL (Add Rule) None window

The **dynamic** fields that can be configured are described below:

Parameter	Description
Fragments	Select the Fragments option to include packet fragment filtering.
Source IP Address	Select and enter the source information here. Options to choose from are Any , Host , and IP . When the Any option is selected, any source traffic will be evaluated according to the conditions of this rule. When the Host option is selected, enter the source host's IP address here. When the IP option is selected, the Wildcard option will also be available. Enter the group of source IP addresses by using a wildcard bitmap. The bit corresponding to the bit value 1 will be ignored. The bit corresponding to the bit value 0 will be checked.
Destination IP Address	Select and enter the destination information here. Options to choose from are Any , Host , and IP . When the Any option is selected, any destination traffic will be evaluated according to the conditions of this rule. When the Host option is selected, enter the destination host's IP address here. When the IP option is selected, the Wildcard option will also be available. Enter the group of destination IP addresses by using a wildcard bitmap. The bit corresponding to the bit value 1 will be ignored. The bit corresponding to the bit value 0 will be checked.
Source MAC Address	Select and enter the source information here. Options to choose from are Any , Host , and MAC . When the Any option is selected, any source traffic will be evaluated according to the conditions of this rule. When the Host option is selected, enter the source host's MAC address here. When the MAC option is selected, the Wildcard option will also be available. Enter the source MAC address and wildcard value in the spaces provided.
Destination MAC Address	Select and enter the destination information here. Options to choose

	from are Any , Host , and MAC . When the Any option is selected, any destination traffic will be evaluated according to the conditions of this rule. When the Host option is selected, enter the destination host's MAC address here. When the MAC option is selected, the Wildcard option will also be available. Enter the destination MAC address and wildcard value in the spaces provided.
IP Precedence	Select the IP precedence value used here. Options to choose from are 0 (routine) , 1 (priority) , 2, (immediate) , 3 (flash) , 4 (flash-override) , 5 (critical) , 6 (internet) , and 7 (network) .
ToS	After selecting the IP precedence value, select the Type-of-Service (ToS) value that will be used here. Options to choose from are 0 (normal) , 1 (min-monetary-cost) , 2 (max-reliability) , 3, 4 (max-throughput) , 5, 6, 7, 8 (min-delay) , 9, 10, 11, 12, 13, 14 , and 15 .
DSCP	Select or enter the DSCP value used here. This value must be between 0 and 63.
VID	Enter the VLAN ID that will be associated with this ACL rule here. This value must be between 1 and 4094.
CoS	Select the Class of Service (CoS) value here. Options to choose from are from 0 to 7 .
Time Range	Enter the name of the time range to associate with this ACL rule.

Click the **Back** button to discard the changes made and return to the previous page.

Click the **Apply** button to accept the changes made.

To enable the **Counter State** option or to enter a **Remark** for the profile, click the **Edit** button, next to the specific ACL profile (found in the ACL profile table).

The screenshot shows the 'ACL Access List' configuration window. At the top, there are search filters for ACL Type (set to 'All'), ID (1-14999), and ACL Name (32 chars). Below this is a table with 6 total entries. The entry with ID 8000 is selected, and its configuration is shown in an expanded view below. The expanded view shows the 'ExtendExpert (ID: 8000) Rule' configuration, including a table for the rule's sequence numbers, actions, and remarks.

ID	ACL Name	ACL Type	Start Sequence No.	Step	Counter State	Remark	Edit	Delete
1	StandardIP	Standard IP ACL	10	10	Enabled		Edit	Delete
2000	ExtendIP	Extended IP ACL	10	10	Enabled		Edit	Delete
6000	ExtendMAC	Extended MAC ACL	10	10	Enabled		Edit	Delete
8000	ExtendExpe...	Extended Expert ACL	10	10	Disabled		Apply	Delete
11000	Standardv6	Standard IPv6 ACL	10	10	Enabled		Edit	Delete
13000	Extendv6	Extended IPv6 ACL	10	10	Enabled		Edit	Delete

Sequence No.	Action	Rule	Time Range	Counter	Delete
10	Permit	any any any any			Delete

Figure 8-101 Extended Expert ACL (Edit ACL) window

The fields that can be configured are described below:

Parameter	Description
Start Sequence No.	Enter the start sequence number here.
Stop	Enter the stop sequence number here.
Counter State	Select to enable or disable the counter state option here.

Remark	Enter an optional remark that will be associated with this profile here.
---------------	--

Click the **Apply** button to accept the changes made.

Click the **Delete** button to remove the specific entry.

To view the list of rules, that are associated with an ACL profile, select the ACL profile (found in the ACL profile table). The rule of ACL rules, connected to the selected ACL profile, will be displayed in the ACL rule table, as shown below:

The screenshot shows the 'ACL Access List' window. At the top, there are search filters for 'ACL Type' (set to 'All') and 'ACL Name' (32 chars). Below this, a table lists 6 ACL entries. The entry with ID 8000 is selected, and its details are shown in a sub-window titled 'ExtendExpert (ID: 8000) Rule'. This sub-window shows a table with one rule: Sequence No. 10, Action Permit, Rule 'any any any any', and Counter '(Ing: 0 packets)'. Navigation buttons like 'Go' and 'Edit/Delete' are visible throughout the interface.

ID	ACL Name	ACL Type	Start Sequence No.	Step	Counter State	Remark
1	StandardIP	Standard IP ACL	10	10	Enabled	
2000	ExtendIP	Extended IP ACL	10	10	Enabled	
6000	ExtendMAC	Extended MAC ACL	10	10	Enabled	
8000	ExtendExpe...	Extended Expert ACL	10	10	Enabled	
11000	Standardv6	Standard IPv6 ACL	10	10	Enabled	
13000	Extendv6	Extended IPv6 ACL	10	10	Enabled	

Sequence No.	Action	Rule	Time Range	Counter
10	Permit	any any any any		(Ing: 0 packets)

Figure 8-102 Extended Expert ACL (Rule Display) window

Click the **Delete** button to remove the specific ACL rule.

Enter a page number and click the **Go** button to navigate to a specific page when multiple pages exist.

ACL Interface Access Group

This window is used to view and configure the ACL interface access group settings.

To view the following window, click **ACL > ACL Interface Access Group**, as shown below:

ACL Interface Access Group

ACL Interface Access Group

Unit: 1 From Port: eth1/0/1 To Port: eth1/0/1 Direction: In Action: Add Type: IP ACL ACL Name: Please Select

Apply

Unit 1 Settings

Port	In			
	IP ACL	IPv6 ACL	MAC ACL	Expert ACL
eth1/0/1				
eth1/0/2				
eth1/0/3				
eth1/0/4				
eth1/0/5				
eth1/0/6				
eth1/0/7				
eth1/0/8				
eth1/0/9				
eth1/0/10				
eth1/0/11				
eth1/0/12				
eth1/0/13				
eth1/0/14				
eth1/0/15				

Figure 8-103 ACL Interface Access Group window

The fields that can be configured are described below:

Parameter	Description
Unit	Select the switch unit that will be used for this configuration here.
From Port / To Port	Select the appropriate port range used for the configuration here.
Direction	Select the direction here. Option to choose from is In .
Action	Select the action that will be taken here. Options to choose from are Add and Delete .
Type	Select the ACL type here. Options to choose from are IP ACL , IPv6 ACL , MAC ACL , and Expert ACL .
ACL Name	Enter the ACL profile's name here. This name can be up to 32 characters long.

Click the **Please Select** button to choose the ACL profile that has been created.

Click the **Apply** button to accept the changes made.

ACL VLAN Access Map

This window is used to view and configure the ACL VLAN access map settings.

To view the following window, click **ACL > ACL VLAN Access Map**, as shown below:

Figure 8-104 ACL VLAN Access Map window

The fields that can be configured are described below:

Parameter	Description
Access Map Name	Enter the access map's name here. This name can be up to 32 characters long.
Sub Map Number	Enter the sub-map's number here. This value must be between 1 and 65535.
Action	Select the action that will be taken here. Options to choose from are Forward , Drop , and Redirect . When the Redirect option is selected, select the redirected interface from the drop-down list.
Counter State	Select whether to enable or disable the counter state.

Click the **Apply** button to accept the changes made for each individual section.

Click the **Clear All Counter** button to clear the counter information for all the access maps.

Click the **Clear Counter** button to clear the counter information for the specified access map.

Click the **Find** button to locate a specific entry based on the information entered.

Click the **Binding** button to configure a new match access list.

Click the **Delete** button to remove the specified entry.

Enter a page number and click the **Go** button to navigate to a specific page when multiple pages exist.

After clicking the **Binding** button, the following page will appear.

Figure 8-105 Match Access-List window

The fields that can be configured are described below:

Parameter	Description
Match IP Access-List	Select the standard or extended IP ACL.
Match IPv6 Access-List	Select the standard or extended IPv6 ACL.
Match MAC Access-List	Select the standard or extended MAC ACL.

Click the **Please Select** button to choose the ACL profile that has been created.

Click the **Apply** button to accept the changes made for each individual section.

Click the **Delete** button to remove the specified entry.

ACL VLAN Filter

This window is used to view and configure the ACL VLAN filter settings.

To view the following window, click **ACL > ACL VLAN Filter**, as shown below:

Figure 8-106 ACL VLAN Filter window

The fields that can be configured are described below:

Parameter	Description
Access Map Name	Enter the access map's name here. This name can be up to 32 characters long.

Action	Select the action that will be taken here. Options to choose from are Add and Delete .
VID List	Enter the VLAN ID list that will be used here. Select the All VLANs option to apply this configuration to all the VLANs configured on this switch.

Click the **Apply** button to accept the changes made.

Click the **Delete** button to remove the specific entry.

Enter a page number and click the **Go** button to navigate to a specific page when multiple pages exist.

9. Security

Port Security
802.1X
AAA
RADIUS
TACACS
IMPB
DHCP Server Screening
ARP Spoofing Prevention
BPDU Attack Protection
MAC Authentication
Web-based Access Control
Japanese Web-based Access Control
Network Access Authentication
Safeguard Engine
Trusted Host
Traffic Segmentation Settings
Storm Control
DoS Attack Prevention Settings
SSH
SSL

Port Security

Port Security Global Settings

This window is used to view and configure the port security global settings. Port Security is a security feature that prevents unauthorized computers (with source MAC addresses) unknown to the Switch prior to locking the port (or ports) from connecting to the Switch's locked ports and gaining access to the network.

To view the following window, click **Security > Port Security > Port Security Global Settings**, as shown below:

The screenshot shows the 'Port Security Global Settings' window with the following configuration:

- Port Security Trap Settings:** Trap State is set to Enabled and Disabled. An **Apply** button is present.
- Port Security Trap Rate Settings:** Trap Rate (0-1000) is set to 0. An **Apply** button is present.
- Port Security System Settings:** System Maximum Address (1-6656) is set to No Limit. An **Apply** button is present.

Figure 9-1 Port Security Global Settings window

The fields that can be configured for **Port Security Trap Settings** are described below:

Parameter	Description
Trap State	Click to enable or disable port security traps on the Switch.

Click the **Apply** button to accept the changes made.

The fields that can be configured for **Port Security Trap Rate Settings** are described below:

Parameter	Description
Trap Rate	Enter the number of traps per second. The range is from 0 to 1000. The default value 0 indicates an SNMP trap to be generated for every security violation.

Click the **Apply** button to accept the changes made.

The fields that can be configured for **Port Security System Settings** are described below:

Parameter	Description
System Maximum Address	Enter the maximum number of secure MAC addresses allowed. If not specified, the default value is No Limit. The valid range is from 1 to 6656. Tick the No Limit checkbox to allow the maximum number of secure MAC address.

Click the **Apply** button to accept the changes made.

Port Security Port Settings

This window is used to view and configure the port security port settings.

To view the following window, click **Security > Port Security > Port Security Port Settings**, as shown below:

Unit	From Port	To Port	State	Maximum (1-6656)	Violation Action	Security Mode	Aging Time (0-1440)	Aging Type
1	eth1/0/1	eth1/0/1	Disabled	32	Shutdown	Delete-on-Timeout		Absolute

Unit 1 Settings									
Port	Maximum	Current No.	Violation Action	Violation Count	Security Mode	Admin State	Current State	Aging Time	Aging Type
eth1/0/1	32	0	Protect	-	Delete-on-Timeout	Disabled	-	0	Absolute
eth1/0/2	32	0	Protect	-	Delete-on-Timeout	Disabled	-	0	Absolute
eth1/0/3	32	0	Protect	-	Delete-on-Timeout	Disabled	-	0	Absolute
eth1/0/4	32	0	Protect	-	Delete-on-Timeout	Disabled	-	0	Absolute
eth1/0/5	32	0	Protect	-	Delete-on-Timeout	Disabled	-	0	Absolute
eth1/0/6	32	0	Protect	-	Delete-on-Timeout	Disabled	-	0	Absolute
eth1/0/7	32	0	Protect	-	Delete-on-Timeout	Disabled	-	0	Absolute
eth1/0/8	32	0	Protect	-	Delete-on-Timeout	Disabled	-	0	Absolute

Figure 9-2 Port Security Port Settings window

The fields that can be configured are described below:

Parameter	Description
Unit	Select the switch unit that will be used for this configuration here.
From Port / To Port	Select the appropriate port range used for the configuration here.
State	Select to enable or disable the port security feature on the port(s) specified.
Maximum	Enter the maximum number of secure MAC addresses that will be allowed on the port(s) specified. This value must be between 1 and 6656. By default, this value is 32.
Violation Action	Select the violation action that will be taken here. Options to choose

	from are Protect , Restrict , and Shutdown . Selecting Protect specifies to drop all packets from the insecure hosts at the port-security process level, but does not increment the security-violation count. Selecting Restrict specifies to drop all packets from the insecure hosts at the port-security process level and increments the security-violation count and record the system log. Selecting Shutdown specifies to shut down the port if there is a security violation and record the system log.
Security Mode	Select the security mode option here. Options to choose from are Permanent and Delete-on-Timeout . Selecting Permanent specifies that under this mode, all learned MAC addresses will not be purged out unless the user manually deletes those entries. Selecting Delete-on-Timeout specifies that under this mode, all learned MAC addresses will be purged out when an entry is aged out or when the user manually deletes these entries.
Aging Time	Enter the aging time value used for auto-learned dynamic secured addresses on the specified port here. This value must be between 0 and 1440 minutes.
Aging Type	Select the aging type here. Options to choose from are Absolute and Inactivity . Selecting Absolute specifies that all the secure addresses on this port age out exactly after the time specified and is removed from the secure address list. This is the default type. Selecting Inactivity specifies that the secure addresses on this port age out only if there is no data traffic from the secure source address for the specified time period.

Click the **Apply** button to accept the changes made.

Port Security Address Entries

This window is used to view, clear and configure the port security address entries.

To view the following window, click **Security > Port Security > Port Security Address Entries**, as shown below:

Figure 9-3 Port Security Address Entries window

The fields that can be configured are described below:

Parameter	Description
Unit	Select the switch unit that will be used for this configuration here.
From Port / To Port	Select the appropriate port range used for the configuration here.
MAC Address	Enter the MAC address here.
VID	Enter the VLAN ID here. This value must be between 1 and 4094.

Click the **Add** button to add a new entry based on the information entered.

Click the **Delete** button to remove a new entry based on the information entered.

Click the **Clear by Port** button to clear the information based on the port selected.

Click the **Clear by MAC** button to clear the information based on the MAC address entered.

Click the **Clear All** button to clear all the information in this table.

Enter a page number and click the **Go** button to navigate to a specific page when multiple pages exist.

802.1X

802.1X (Port-based and Host-based Access Control)

The IEEE 802.1X standard is a security measure for authorizing and authenticating users to gain access to various wired or wireless devices on a specified Local Area Network by using a Client and Server based access control model. This is accomplished by using a RADIUS server to authenticate users trying to access a network by relaying Extensible Authentication Protocol over LAN (EAPOL) packets between the Client and the Server.

The following figure represents a basic EAPOL packet:

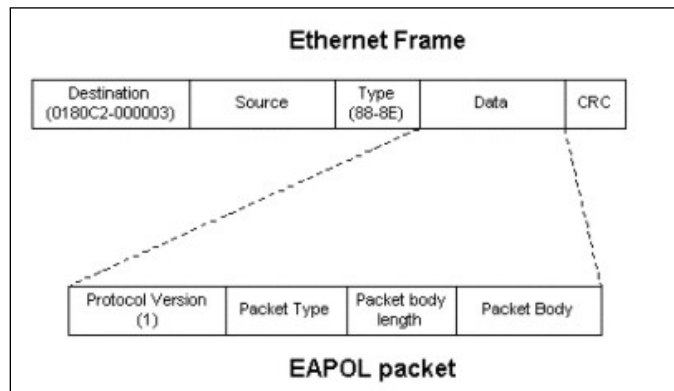

Figure 9-4 The EAPOL Packet

Utilizing this method, unauthorized devices are restricted from connecting to a LAN through a port to which the user is connected. EAPOL packets are the only traffic that can be transmitted through the specific port until authorization is granted. The 802.1X access control method has three roles, each of which are vital to creating and up keeping a stable and working Access Control security method.

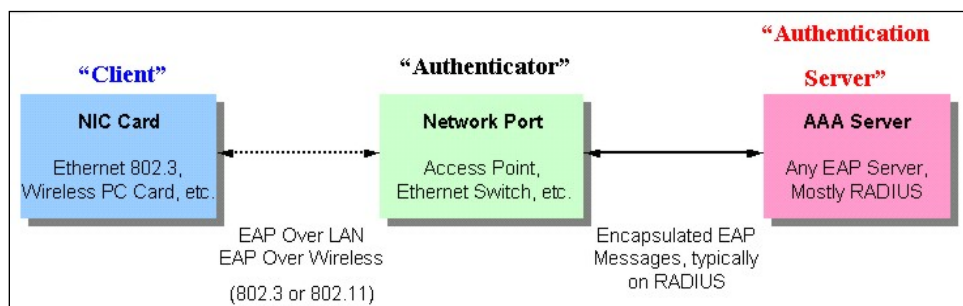

Figure 9-5 The three roles of 802.1X

The following section will explain the three roles of Client, Authenticator and Authentication Server in greater detail.

Authentication Server

The Authentication Server is a remote device that is connected to the same network as the Client and Authenticator, must be running a RADIUS Server program and must be configured properly on the Authenticator (Switch). Clients connected to a port on the Switch must be authenticated by the Authentication Server (RADIUS) before attaining any services offered by the Switch on the LAN. The role of the Authentication Server is to certify the identity of the Client attempting to access the network by exchanging secure information between the RADIUS server and the Client through EAPOL packets and, in turn, informs the Switch whether or not the Client is granted access to the LAN and/or switches services.

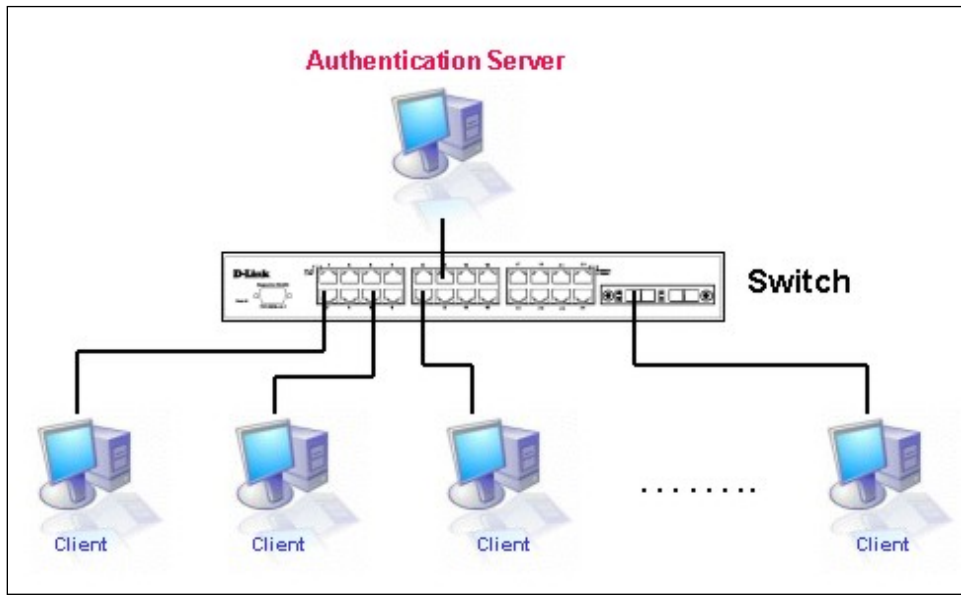

Figure 9-6 The Authentication Server

Authenticator

The Authenticator (the Switch) is an intermediary between the Authentication Server and the Client. The Authenticator serves two purposes when utilizing the 802.1X function. The first purpose is to request certification information from the Client through EAPOL packets, which is the only information allowed to pass through the Authenticator before access is granted to the Client. The second purpose of the Authenticator is to verify the information gathered from the Client with the Authentication Server, and to then relay that information back to the Client.

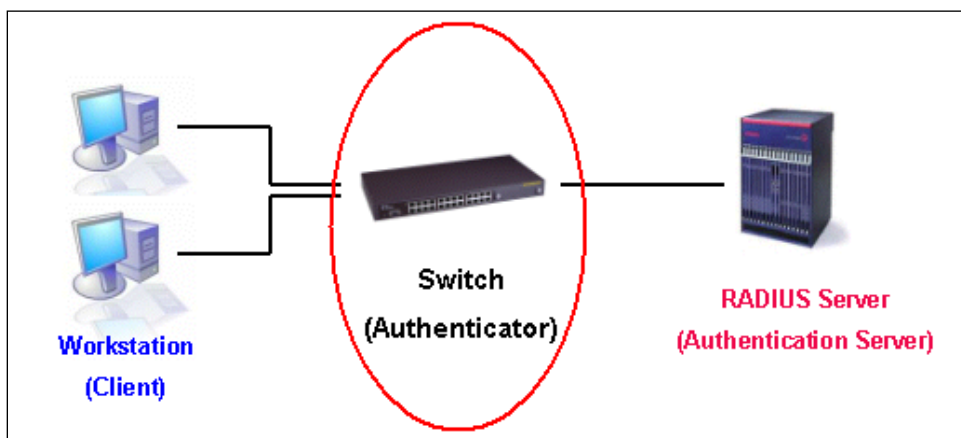

Figure 9-7 The Authenticator

Three steps must be implemented on the Switch to properly configure the Authenticator.

- The 802.1X State must be **Enabled**. (**Security > 802.1X > 802.1X Global Settings**)
- The 802.1X settings must be implemented by port (**Security > 802.1X > 802.1X Port Settings**)
- A RADIUS server must be configured on the Switch. (**Security > RADIUS > RADIUS Server Settings**)

Client

The Client is simply the end station that wishes to gain access to the LAN or switch services. All end stations must be running software that is compliant with the 802.1X protocol. For users running windows XP and windows Vista, that software is included within the operating system. All other users are required to attain 802.1X client software from an outside source. The Client will request access to the LAN and or Switch through EAPOL packets and, in turn will respond to requests from the Switch.

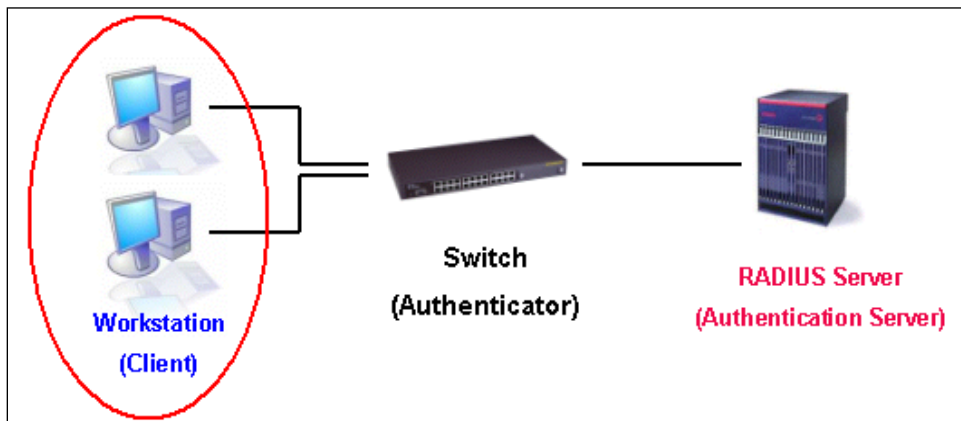

Figure 9-8 The Client

Authentication Process

Utilizing the three roles stated above, the 802.1X protocol provides a stable and secure way of authorizing and authenticating users attempting to access the network. Only EAPOL traffic is allowed to pass through the specified port before a successful authentication is made. This port is "locked" until the point when a Client with the correct username and password (and MAC address if 802.1X is enabled by MAC address) is granted access and therefore successfully "unlocks" the port. Once unlocked, normal traffic is allowed to pass through the port. The following figure displays a more detailed explanation of how the authentication process is completed between the three roles stated above.

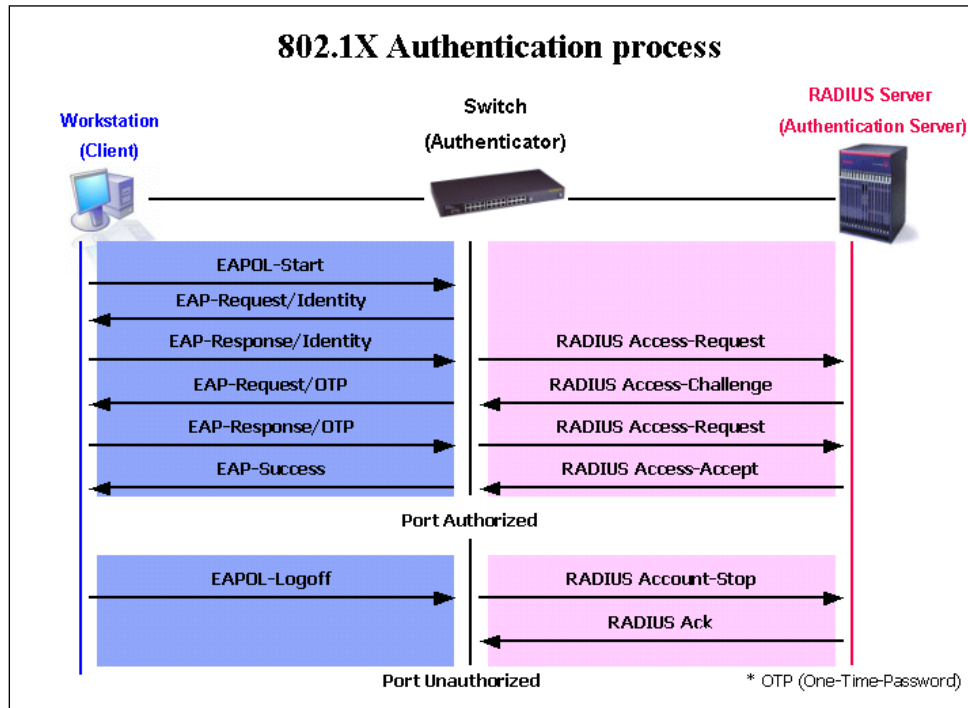

Figure 9-9 The 802.1X Authentication Process

The D-Link implementation of 802.1X allows network administrators to choose between two types of Access Control used on the Switch, which are:

- **Port-based Access Control** – This method requires only one user to be authenticated per port by a remote RADIUS server to allow the remaining users on the same port access to the network.
- **Host-based Access Control** – Using this method, the Switch will automatically learn up to a maximum of 448 MAC addresses by port and set them in a list. Each MAC address must be authenticated by the Switch using a remote RADIUS server before being allowed access to the Network.

Understanding 802.1X Port-based and Host-based Network Access Control

The original intent behind the development of 802.1X was to leverage the characteristics of point-to-point in LANs. As any single LAN segment in such infrastructures has no more than two devices attached to it, one of which is a Bridge Port. The Bridge Port detects events that indicate the attachment of an active device at the remote end of the link, or an active device becoming inactive. These events can be used to control the authorization state of the Port and initiate the process of authenticating the attached device if the Port is unauthorized. This is the Port-based Network Access Control.

Port-based Network Access Control

Once the connected device has successfully been authenticated, the Port then becomes Authorized, and all subsequent traffic on the Port is not subject to access control restriction until an event occurs that causes the Port to become Unauthorized. Hence, if the Port is actually connected to a shared media LAN segment with more than one attached device, successfully authenticating one of the attached devices effectively provides access to the LAN for all devices on the shared segment. Clearly, the security offered in this situation is open to attack.

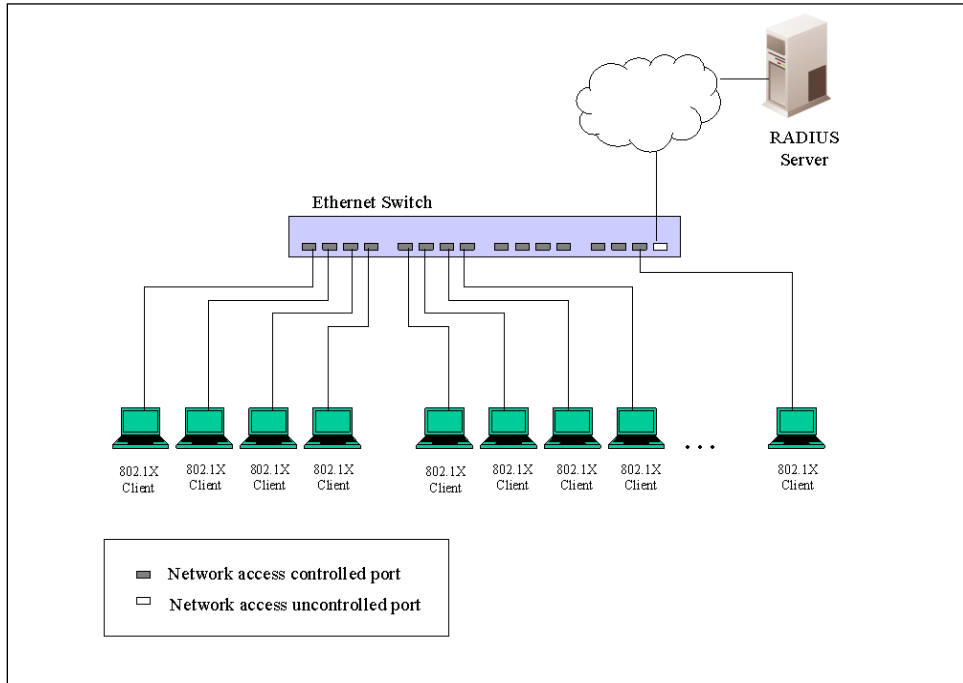

Figure 9-10 Example of Typical Port-based Configuration

Host-based Network Access Control

In order to successfully make use of 802.1X in a shared media LAN segment, it would be necessary to create “logical” Ports, one for each attached device that required access to the LAN. The Switch would regard the single physical Port connecting it to the shared media segment as consisting of a number of distinct logical Ports, each logical Port being independently controlled from the point of view of EAPOL exchanges and authorization state. The Switch learns each attached devices’ individual MAC addresses, and effectively creates a logical Port that the attached device can then use to communicate with the LAN via the Switch.

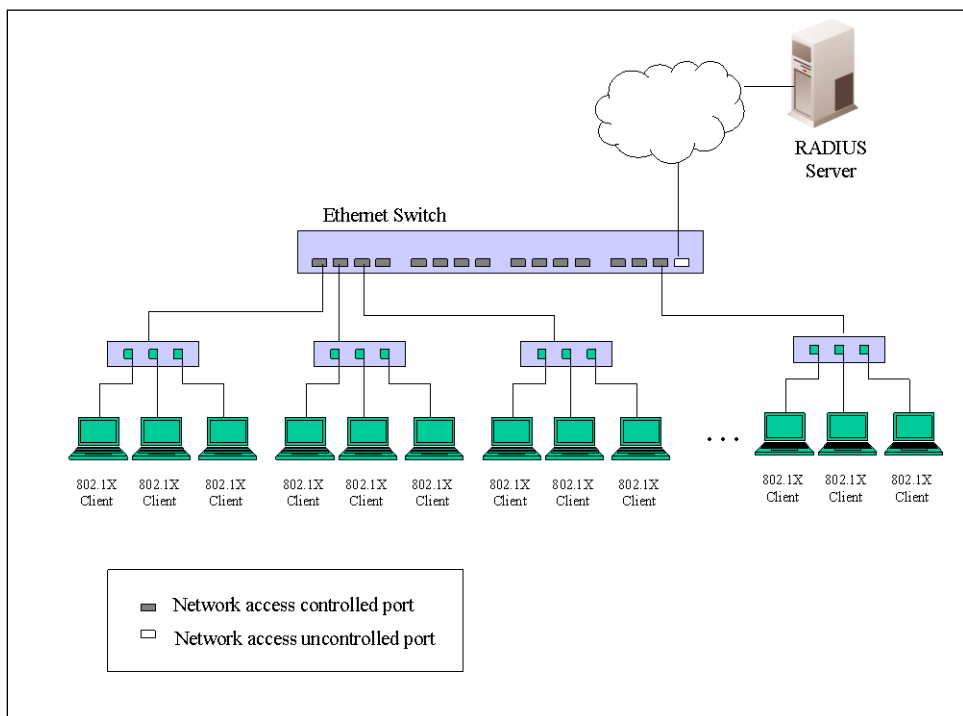
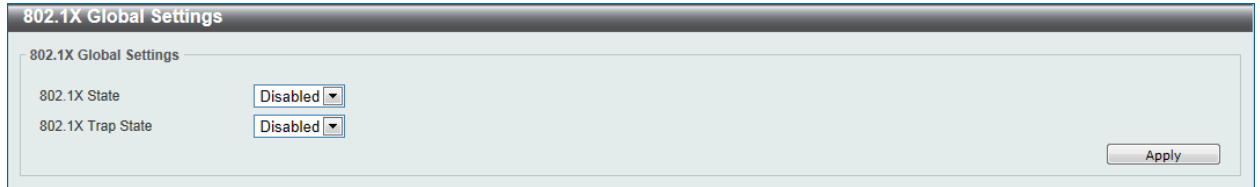

Figure 9-11 Example of Typical Host-based Configuration

802.1X Global Settings

This window is used to view and configure the 802.1X global settings.

To view the following window, click **Security > 802.1X > 802.1X Global Settings**, as shown below:



The screenshot shows a web interface window titled "802.1X Global Settings". The window contains two configuration items: "802.1X State" and "802.1X Trap State". Both are currently set to "Disabled" using dropdown menus. An "Apply" button is visible in the bottom right corner of the window.

Figure 9-12 802.1X Global Settings window

The fields that can be configured are described below:

Parameter	Description
802.1X State	Select to enable or disable the 802.1X global state here.
802.1X Trap State	Select to enable or disable the 802.1X trap state here.

Click the **Apply** button to accept the changes made.

802.1X Port Settings

This window is used to view and configure the 802.1X port settings.

To view the following window, click **Security > 802.1X > 802.1X Port Settings**, as shown below:

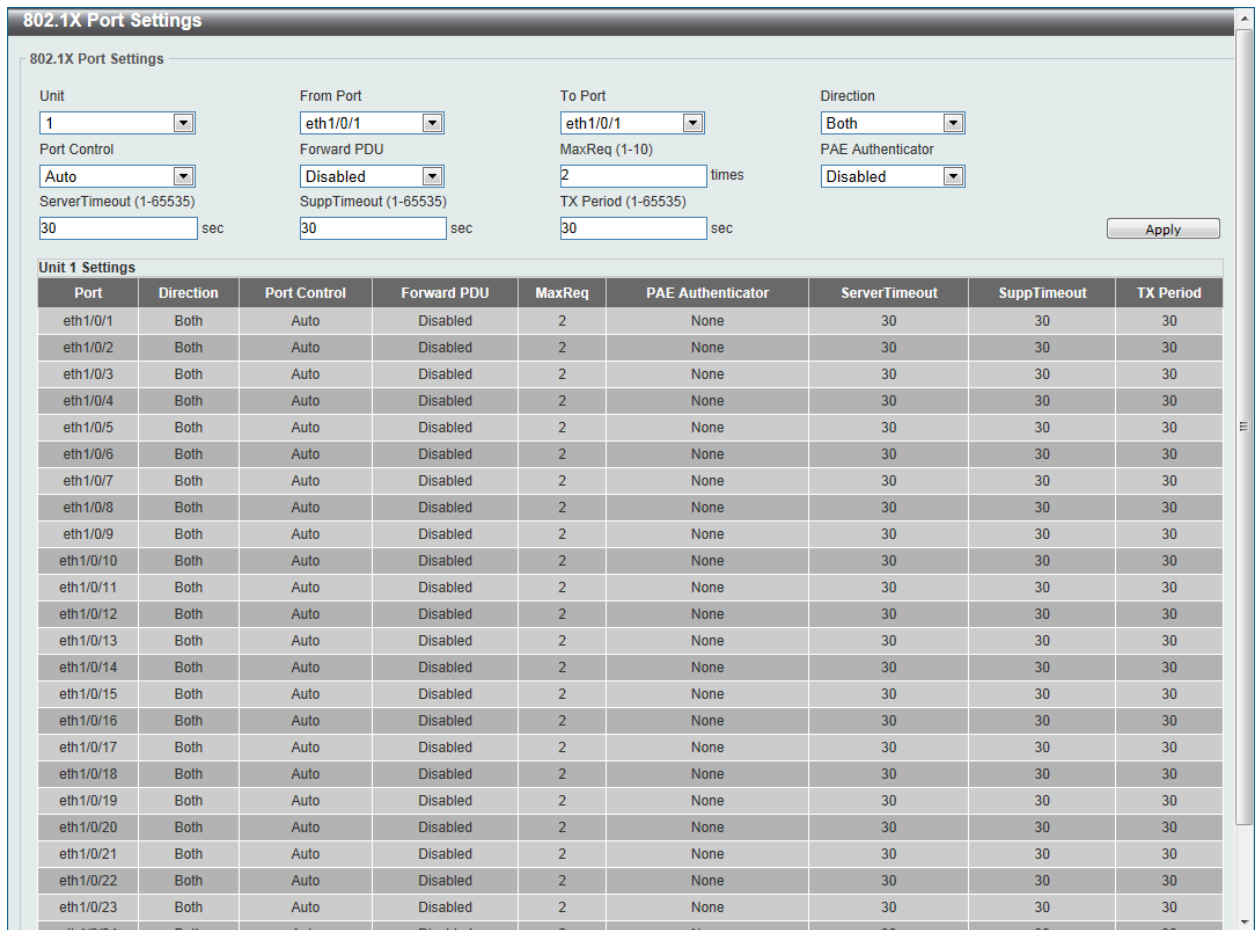

Figure 9-13 802.1X Port Settings window

The fields that can be configured are described below:

Parameter	Description
Unit	Select the switch unit that will be used for this configuration here.
From Port / To Port	Select the appropriate port range used for the configuration here.
Direction	Select the direction here. Options to choose from are Both and In . This option configures the direction of the traffic on a controlled port as unidirectional (In) or bidirectional (Both).
Port Control	Select the port control option here. Options to choose from are ForceAuthorized , Auto , and ForceUnauthorized . If the port control is set to force-authorized, then the port is not controlled in both directions. If the port control is set to automatic, then the access to the port for the controlled direction needs to be authenticated. If the port control is set to force-unauthorized, then the access to the port for the controlled direction is blocked.
Forward PDU	Select to enable or disable the forward PDU option here.
MaxReq	Enter the maximum required times value here. This value must be between 1 and 10. By default, this option is 2. This option configures the maximum number of times that the backend authentication state machine will retransmit an Extensible Authentication Protocol (EAP) request frame to the supplicant before restarting the authentication process.
PAE Authenticator	Select to enable or disable the PAE authenticator option here. This option configures a specific port as an IEEE 802.1X port access entity

	(PAE) authenticator.
Server Timeout	Enter the server timeout value here. This value must be between 1 and 65535 seconds. By default, this value is 30 seconds.
Supp Timeout	Enter the supplicant timeout value here. This value must be between 1 and 65535 seconds. By default, this value is 30 seconds.
TX Period	Enter the transmission period value here. This value must be between 1 and 65535 seconds. By default, this value is 30 seconds.

Click the **Apply** button to accept the changes made.

Authentication Session Information

This window is used to view and configure the authentication session information.

To view the following window, click **Security > 802.1X > Authentication Session Information**, as shown below:

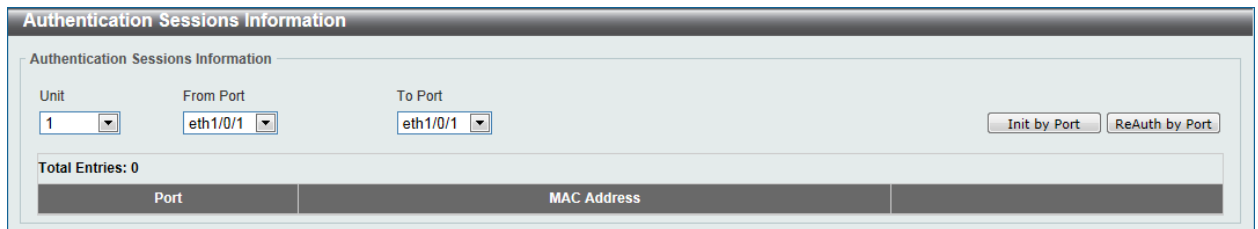

Figure 9-14 Authentication Session Information window

The fields that can be configured are described below:

Parameter	Description
Unit	Select the switch unit that will be used for this configuration here.
From Port / To Port	Select the appropriate port range used for the configuration here.

Click the **Init by Port** button to initiate the session information based on the selections made.

Click the **ReAuth by Port** button to re-authenticate the session information based on the selections made.

Authenticator Statistics

This window is used to view and clear the authenticator statistics.

To view the following window, click **Security > 802.1X > Authenticator Statistics**, as shown below:

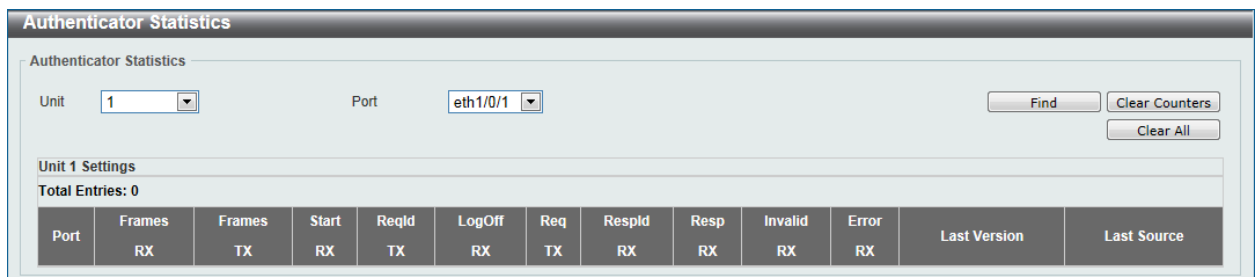

Figure 9-15 Authenticator Statistics window

The fields that can be configured are described below:

Parameter	Description
Unit	Select the switch unit that will be used for this query here.
Port	Select the appropriate port used for the query here.

Click the **Find** button to locate a specific entry based on the information entered.

Click the **Clear Counters** button to clear the counter information based on the selections made.

Click the **Clear All** button to clear all the information in this table.

Authenticator Session Statistics

This window is used to view and clear the authenticator session statistics.

To view the following window, click **Security > 802.1X > Authenticator Session Statistics**, as shown below:

Figure 9-16 Authenticator Session Statistics window

The fields that can be configured are described below:

Parameter	Description
Unit	Select the switch unit that will be used for this query here.
Port	Select the appropriate port used for the query here.

Click the **Find** button to locate a specific entry based on the information entered.

Click the **Clear Counters** button to clear the counter information based on the selections made.

Click the **Clear All** button to clear all the information in this table.

Authenticator Diagnostics

This window is used to view and clear the authenticator diagnostics information.

To view the following window, click **Security > 802.1X > Authenticator Diagnostics**, as shown below:

Figure 9-17 Authenticator Diagnostics window

The fields that can be configured are described below:

Parameter	Description
Unit	Select the switch unit that will be used for this query here.
Port	Select the appropriate port used for the query here.

Click the **Find** button to locate a specific entry based on the information entered.

Click the **Clear Counters** button to clear the counter information based on the selections made.

Click the **Clear All** button to clear all the information in this table.

AAA

AAA Global Settings

This window is used to enable or disable the Authentication, Authorization, and Accounting (AAA) global state.

To view the following window, click **Security > AAA > AAA Global Settings**, as shown below:

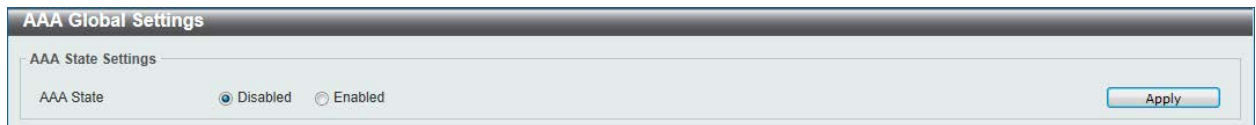

Figure 9-18 AAA Global Settings window

The fields that can be configured are described below:

Parameter	Description
AAA State	Select to enable or disable the Authentication, Authorization, and Accounting (AAA) global state.

Click the **Apply** button to accept the changes made.

Application Authentication Settings

This window is used to view and configure the application authentication settings.

To view the following window, click **Security > AAA > Application Authentication Settings**, as shown below:

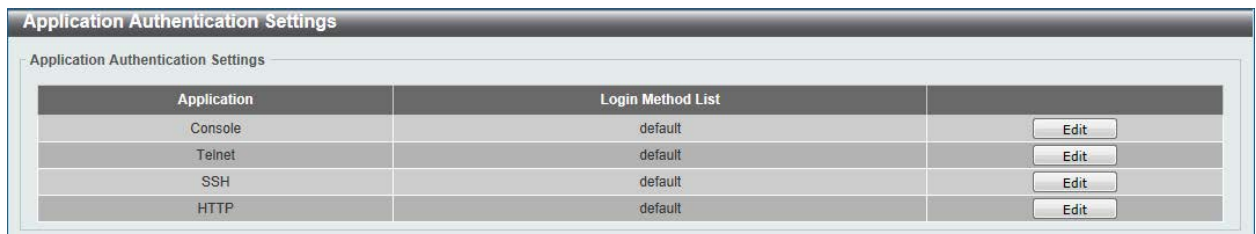

Figure 9-19 Application Authentication Settings window

The fields that can be configured are described below:

Parameter	Description
Login Method List	After clicking the Edit button for the specific entry, enter the login method list name used here.

Click the **Edit** button to re-configure the specific entry.

Click the **Apply** button to accept the changes made.

Application Accounting Settings

This window is used to view and configure the application accounting settings.

To view the following window, click **Security > AAA > Application Accounting Settings**, as shown below:

Figure 9-20 Application Accounting Settings window

The fields that can be configured are described below:

Parameter	Description
Exec Method List	After clicking the Edit button for the specific entry, enter the EXEC method list name used here.
Application	Select the application used here. Options to choose from are Console , Telnet , and SSH .
Level	Select the privilege level used here. Options to choose from are levels 1 to 15 .
Commands Method List	Enter the commands method list name used here.

Click the **Edit** button to re-configure the specific entry.

Click the **Apply** button to accept the changes made.

Click the **Delete** button to remove the specified entry.

Enter a page number and click the **Go** button to navigate to a specific page when multiple pages exist.

Authentication Settings

This window is used to view and configure the AAA network and EXEC authentication settings.

To view the following window, click **Security > AAA > Authentication Settings**, as shown below:

Figure 9-21 Authentication Settings window

The fields that can be configured for **AAA Authentication 802.1X** are described below:

Parameter	Description
Status	Select to enable or disable the AAA 802.1X authentication state here.
Method 1 to 4	Select the method lists that will be used for this configuration here. Options to choose from are none , local , group and radius .

Click the **Apply** button to accept the changes made.

The fields that can be configured for **AAA Authentication JWAC** are described below:

Parameter	Description
Status	Select to enable or disable the AAA JWAC authentication state here.
Method 1 to 4	Select the method lists that will be used for this configuration here. Options to choose from are none , local , group and radius .

Click the **Apply** button to accept the changes made.

The fields that can be configured for **AAA Authentication MAC-Auth** are described below:

Parameter	Description
Status	Select to enable or disable the AAA MAC authentication state here.
Method 1 to 4	Select the method lists that will be used for this configuration here. Options to choose from are none , local , group and radius .

Click the **Apply** button to accept the changes made.

The fields that can be configured for **AAA Authentication WEB-Auth** are described below:

Parameter	Description
Status	Select to enable or disable the AAA Web authentication state here.
Method 1 to 4	Select the method lists that will be used for this configuration here. Options to choose from are none , local , group and radius .

Click the **Apply** button to accept the changes made.

After clicking the **AAA Authentication Exec** tab, the following page will appear.

Figure 9-22 AAA Authentication Exec window

The fields that can be configured for **AAA Authentication Enable** are described below:

Parameter	Description
Status	Select to enable or disable the AAA authentication enable state here.
Method 1 to 4	Select the method lists that will be used for this configuration here. Options to choose from are none , enable , group , radius , and tacacs+ .

Click the **Apply** button to accept the changes made.

The fields that can be configured for **AAA Authentication Login** are described below:

Parameter	Description
List Name	Enter the method list name that will be used with the AAA authentication login option here.
Status	Select to enable or disable the AAA authentication login state here.
Method 1 to 4	Select the method lists that will be used for this configuration here. Options to choose from are none , enable , group , radius , and tacacs+ .

Click the **Apply** button to accept the changes made.

Click the **Delete** button to remove the specified entry.

Accounting Settings

This window is used to view and configure the AAA accounting settings.

To view the following window, click **Security > AAA > Accounting Settings**, as shown below:

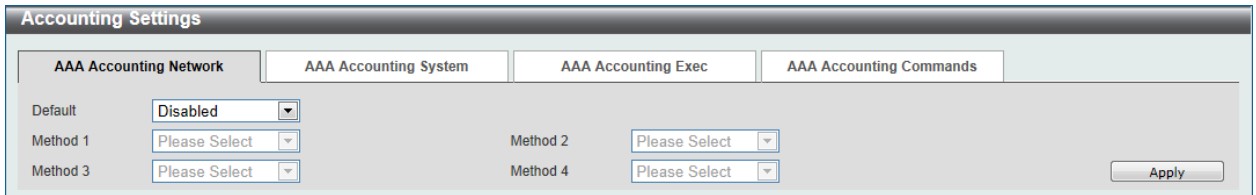

Figure 9-23 Accounting Settings window

The fields that can be configured are described below:

Parameter	Description
Default	Select to enable or disable the use of the default method list here.
Method 1 to 4	Select the method lists that will be used for this configuration here. Options to choose from are none , group , radius , and tacacs+ .

Click the **Apply** button to accept the changes made.

After clicking the **AAA Accounting System** tab, the following page will appear.

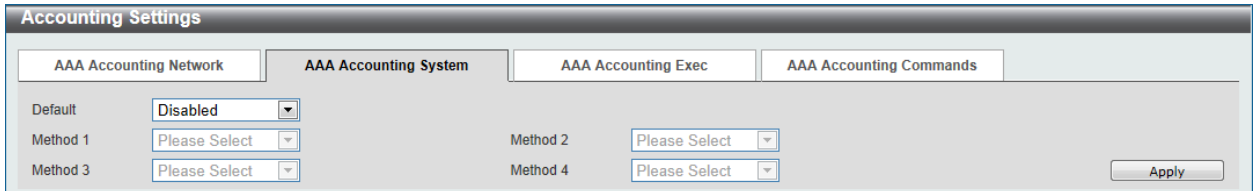

Figure 9-24 AAA Accounting System window

The fields that can be configured are described below:

Parameter	Description
Default	Select to enable or disable the use of the default method list here.
Method 1 to 4	Select the method lists that will be used for this configuration here. Options to choose from are none , group , radius , and tacacs+ .

Click the **Apply** button to accept the changes made.

After clicking the **AAA Accounting Exec** tab, the following page will appear.

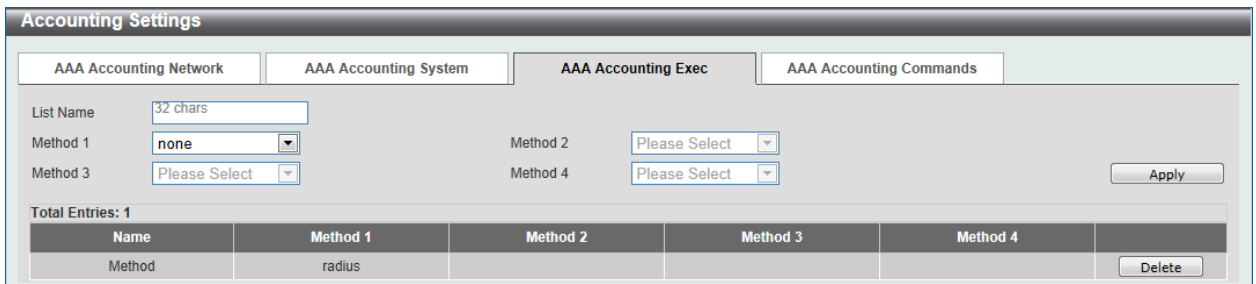

Figure 9-25 AAA Accounting Exec window

The fields that can be configured are described below:

Parameter	Description
List Name	Enter the method list name that will be used with the AAA accounting EXEC option here.
Method 1 to 4	Select the method lists that will be used for this configuration here. Options to choose from are none , group , radius , and tacacs+ .

Click the **Apply** button to accept the changes made.

Click the **Delete** button to remove the specified entry.

After clicking the **AAA Accounting Commands** tab, the following page will appear.

Figure 9-26 AAA Accounting Commands window

The fields that can be configured are described below:

Parameter	Description
Level	Select the privilege level used here. Options to choose from are levels 1 to 15 .
List Name	Enter the method list name that will be used with the AAA accounting commands option here.
Method	Select the method lists that will be used for this configuration here. Options to choose from are none , group , and tacacs+ .

Click the **Apply** button to accept the changes made.

Click the **Delete** button to remove the specified entry.

Enter a page number and click the **Go** button to navigate to a specific page when multiple pages exist.

RADIUS

RADIUS Global Settings

This window is used to view and configure the RADIUS global settings.

To view the following window, click **Security > RADIUS > RADIUS Global Settings**, as shown below:

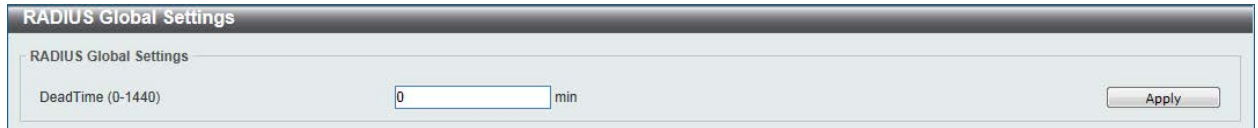

Figure 9-27 RADIUS Global Settings window

The fields that can be configured are described below:

Parameter	Description
Dead Time	<p>Enter the dead time value here. This value must be between 1 and 1440 minutes. By default, this value is 0 minutes. When this option is 0, the unresponsive server will not be marked as dead. This setting can be used to improve the authentication processing time by setting the dead time to skip the unresponsive server host entries.</p> <p>When the system performs authentication with the authentication server, it attempts one server at a time. If the attempted server does not respond, the system will attempt the next server. When the system finds a server does not respond, it will mark the server as down, start a dead time timer, and skip them in authentication of the following requests until expiration of the dead time.</p>

Click the **Apply** button to accept the changes made.

RADIUS Server Settings

This window is used to view and configure the RADIUS server settings.

To view the following window, click **Security > RADIUS > RADIUS Server Settings**, as shown below:



Figure 9-28 RADIUS Server Settings window

The fields that can be configured are described below:

Parameter	Description
IP Address	Enter the RADIUS server's IPv4 address here.
IPv6 Address	Enter the RADIUS server's IPv6 address here.
Authentication Port	Enter the authentication port number used here. This value must be between 0 and 65535. By default, this value is 1812. If no authentication is used, use the value 0.
Accounting Port	Enter the accounting port number used here. This value must be between 0 and 65535. By default, this value is 1813. If no accounting is used, use the value 0.
Retransmit	Enter the retransmit value used here. This value must be between 0

	and 20. By default, this value is 3. To disable this option, enter the value 0.
Timeout	Enter the timeout value used here. This value must be between 1 and 255 seconds. By default, this value is 5 seconds.
Key Type	Select the key type that will be used here. Options to choose from are Plain Text and Encrypted .
Key	Enter the key, used to communicate with the RADIUS server, here. This key can be up to 32 characters long.

Click the **Apply** button to accept the changes made.

Click the **Delete** button to remove the specified entry.

RADIUS Group Server Settings

This window is used to view and configure the RADIUS group server settings.

To view the following window, click **Security > RADIUS > RADIUS Group Server Settings**, as shown below:

Figure 9-29 RADIUS Group Server Settings window

The fields that can be configured are described below:

Parameter	Description
Group Server Name	Enter the RADIUS group server's name here. This name can be up to 15 characters long.
IP Address	Enter the group server's IPv4 address here.
IPv6 Address	Enter the group server's IPv6 address here.

Click the **Add** button to add a new entry based on the information entered.

Click the **Delete** button to remove the specified entry.

Click the **Detail** button to view and configure more detailed settings for the RADIUS group server.

After clicking the **Detail** button, the following page will be available.

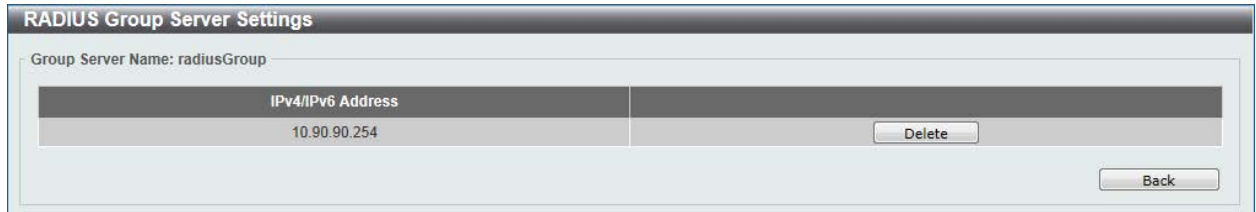

Figure 9-30 RADIUS Group Server Settings - Detail window

Click the **Delete** button to remove the specified entry.

Click the **Back** button to return to the previous window.

RADIUS Statistic

This window is used to view and clear the RADIUS statistics information.

To view the following window, click **Security > RADIUS > RADIUS Statistic**, as shown below:

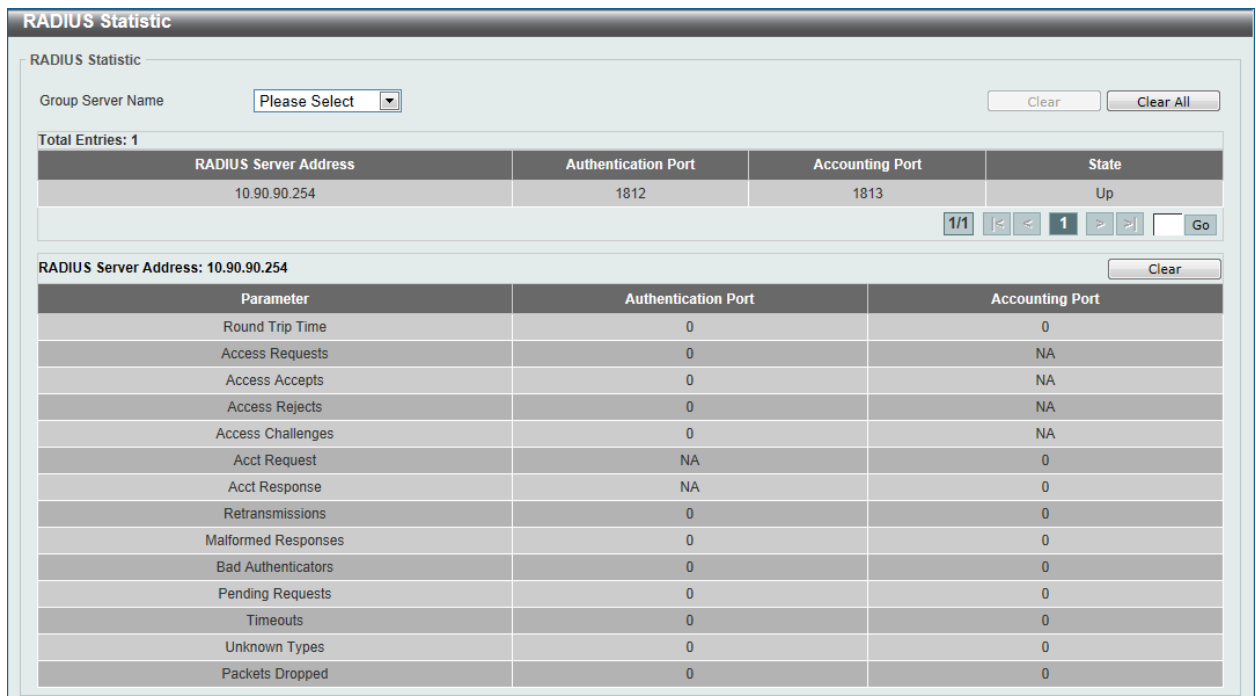

Figure 9-31 RADIUS Statistic window

The fields that can be configured are described below:

Parameter	Description
Group Server Name	Select the RADIUS group server name from this list here.

Click the **Clear** button to clear the information based on the selections made.

Click the **Clear All** button to clear all the information in this table.

Enter a page number and click the **Go** button to navigate to a specific page when multiple pages exist.

TACACS

TACACS Server Settings

This window is used to view and configure the TACACS server settings.

To view the following window, click **Security > TACACS > TACACS Server Settings**, as shown below:

IPv4/IPv6 Address	Port	Timeout	Key
10.90.90.254	49	5	*****

Figure 9-32 TACACS Server Settings window

The fields that can be configured are described below:

Parameter	Description
IP Address	Enter the TACACS server's IPv4 address here.
IPv6 Address	Enter the TACACS server's IPv6 address here.
Port	Enter the port number used here. This value must be between 1 and 65535. By default, this value is 49.
Timeout	Enter the timeout value here. This value must be between 1 and 255 seconds. By default, this value is 5 seconds.
Key Type	Select the key type that will be used here. Options to choose from are Plain Text and Encrypted .
Key	Enter the key, used to communicate with the TACACS server, here. This key can be up to 254 characters long.

Click the **Apply** button to accept the changes made.

Click the **Delete** button to remove the specified entry.

TACACS Group Server Settings

This window is used to view and configure the TACACS group server settings.

To view the following window, click **Security > TACACS > TACACS Group Server Settings**, as shown below:

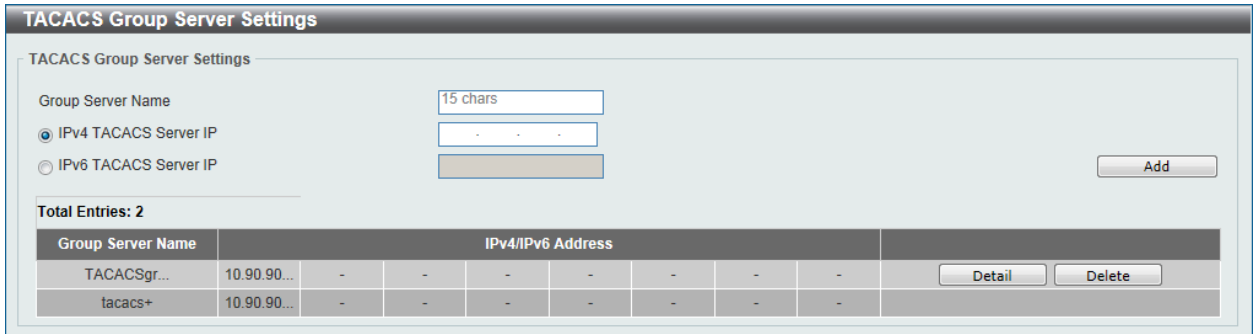

Figure 9-33 TACACS Group Server Settings window

The fields that can be configured are described below:

Parameter	Description
Group Server Name	Enter the TACACS group server's name here. This name can be up to 15 characters long.
IPv4 TACACS Server IP	Enter the group server's IPv4 address here.
IPv6 TACACS Server IP	Enter the group server's IPv6 address here.

Click the **Add** button to add a new entry based on the information entered.

Click the **Delete** button to remove the specified entry.

Click the **Detail** button to view and configure more detailed settings for the TACACS group server.

After clicking the **Detail** button, the following page will be available.

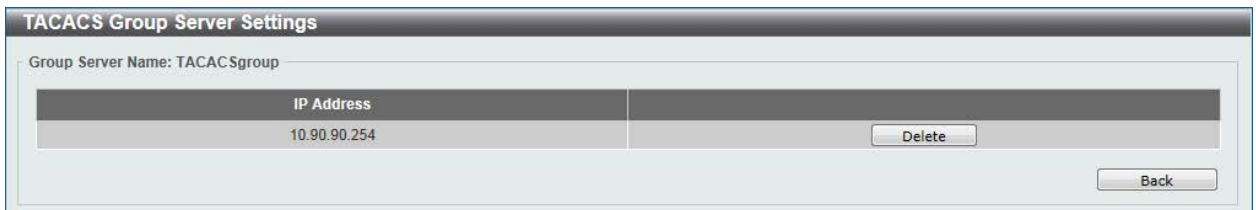

Figure 9-34 TACACS Group Server Settings - Detail window

Click the **Delete** button to remove the specified entry.

Click the **Back** button to return to the previous window.

TACACS Statistic

This window is used to view and clear the TACACS statistic information.

To view the following window, click **Security > TACACS > TACACS Statistic**, as shown below:

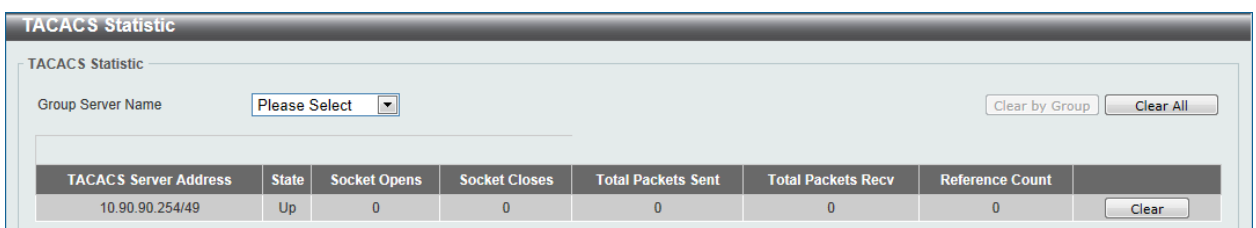

Figure 9-35 TACACS Statistic window

The fields that can be configured are described below:

Parameter	Description
Group Server Name	Select the TACACS group server name from this list here.

Click the **Clear by Group** button to clear the information based on the group selected.

Click the **Clear All** button to clear all the information in this table.

Click the **Clear** button to clear all the information for the specific port.

IMPB

The IP network layer uses a four-byte address. The Ethernet link-layer uses a six-byte MAC address. Binding these two address types together allows the transmission of data between the layers. The primary purpose of IP-MAC-Port Binding (IMPB) is to restrict the access to a switch to a number of authorized users. Authorized clients can access a switch's port by either checking the pair of IP-MAC addresses with the pre-configured database or if DHCP snooping has been enabled in which case the switch will automatically learn the IP/MAC pairs by snooping DHCP packets and saving them to the IMPB white list. If an unauthorized user tries to access an IP-MAC binding enabled port, the system will block the access by dropping its packet. Active and inactive entries use the same database. The function is port-based, meaning a user can enable or disable the function on the individual port.

IPv4

DHCPv4 Snooping

DHCP Snooping Global Settings

This window is used to view and configure the DHCP snooping global settings.

To view the following window, click **Security > IMPB > IPv4 > DHCPv4 Snooping > DHCP Snooping Global Settings**, as shown below:

DHCP Snooping Global Settings		
DHCP Snooping	<input type="radio"/> Enabled	<input checked="" type="radio"/> Disabled
Information Option Allow Untrusted	<input type="radio"/> Enabled	<input checked="" type="radio"/> Disabled
Source MAC Verification	<input type="radio"/> Enabled	<input checked="" type="radio"/> Disabled
Station Move Deny	<input type="radio"/> Enabled	<input checked="" type="radio"/> Disabled

Figure 9-36 DHCP Snooping Global Settings window

The fields that can be configured are described below:

Parameter	Description
DHCP Snooping	Select to enable or disable the DHCP snooping global status.
Information Option Allow Untrusted	Select to enable or disable the option to globally allow DHCP packets with the relay Option 82 on the untrusted interface.
Source MAC Verification	Select to enable or disable the verification that the source MAC address in a DHCP packet matches the client hardware address.
Station Move Deny	Select to enable or disable the DHCP snooping station move state.

When DHCP snooping station move is enabled, the dynamic DHCP snooping binding entry with the same VLAN ID and MAC address on the specific port can move to another port if it detects that a new DHCP process belong to the same VLAN ID and MAC address.

Click the **Apply** button to accept the changes made.

DHCP Snooping Port Settings

This window is used to view and configure the DHCP snooping port settings.

To view the following window, click **Security > IMPB > IPv4 > DHCPv4 Snooping > DHCP Snooping Port Settings**, as shown below:

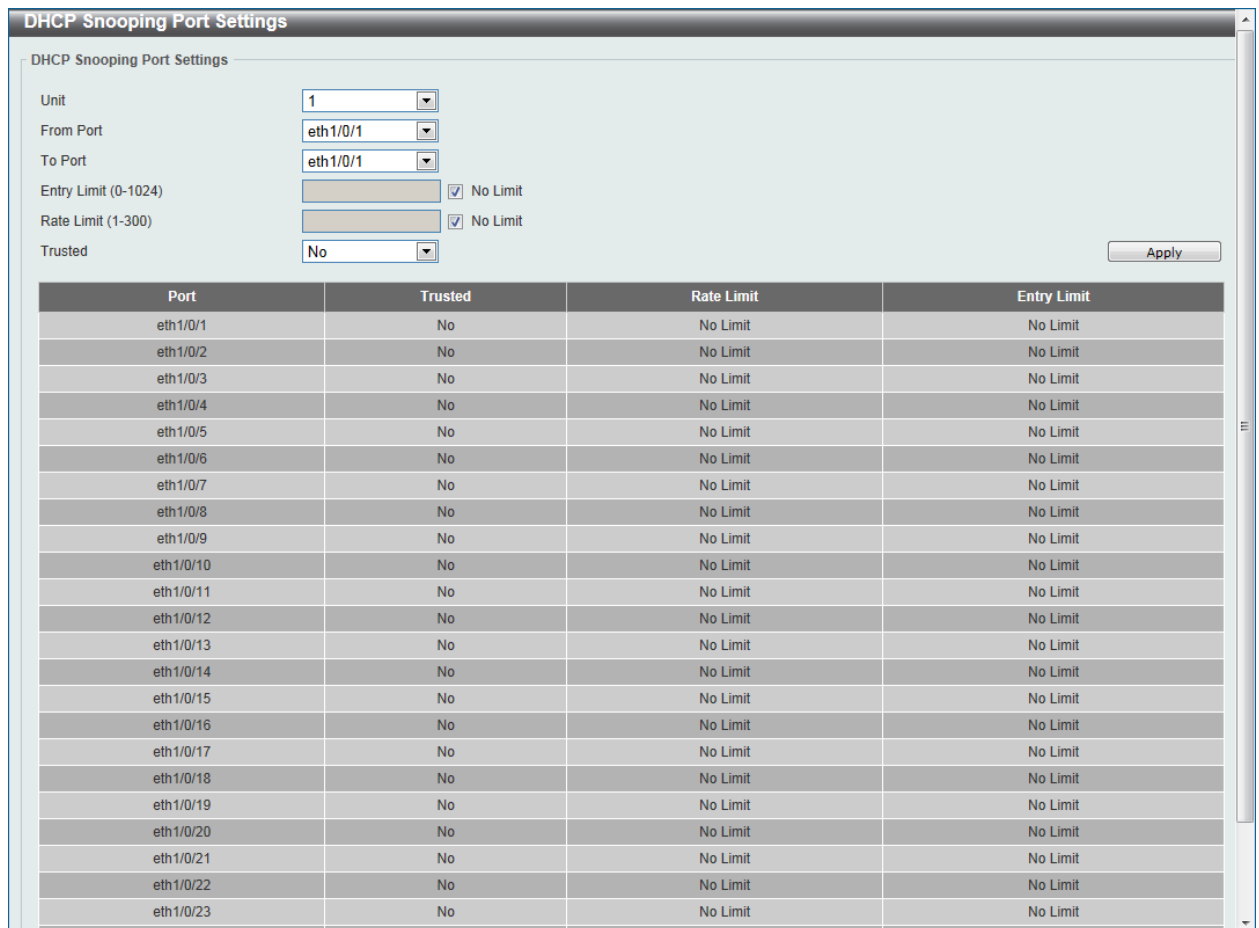

Figure 9-37 DHCP Snooping Port Settings window

The fields that can be configured are described below:

Parameter	Description
Unit	Select the switch unit that will be used for this configuration here.
From Port / To Port	Select the appropriate port range used for the configuration here.
Entry Limit	Enter the entry limit value here. This value must be between 0 and 1024. Tick the No Limit option to disable the function.
Rate Limit	Enter the rate limit value here. This value must be between 1 and 300. Tick the No Limit option to disable the function.

Trusted	Select the trusted option here. Options to choose from are No and Yes . Ports connected to the DHCP server or to other switches should be configured as trusted interfaces. The ports connected to DHCP clients should be configured as untrusted interfaces. DHCP snooping acts as a firewall between untrusted interfaces and DHCP servers.
----------------	---

Click the **Apply** button to accept the changes made.

DHCP Snooping VLAN Settings

This window is used to view and configure the DHCP snooping VLAN settings.

To view the following window, click **Security > IMPB > IPv4 > DHCPv4 Snooping > DHCP Snooping VLAN Settings**, as shown below:

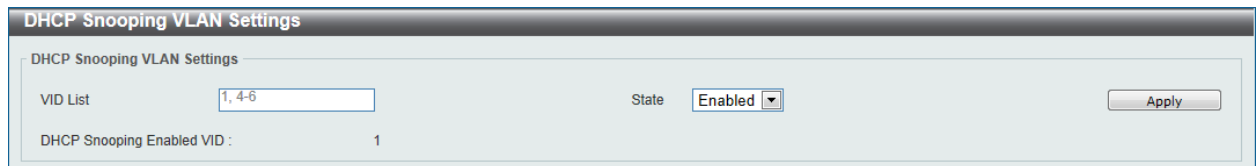

Figure 9-38 DHCP Snooping VLAN Settings window

The fields that can be configured are described below:

Parameter	Description
VID List	Enter the VLAN ID list used here.
State	Select to enable or disable the DHCP snooping VLAN setting here.

Click the **Apply** button to accept the changes made.

DHCP Snooping Database

This window is used to view and configure the DHCP snooping database settings.

To view the following window, click **Security > IMPB > IPv4 > DHCPv4 Snooping > DHCP Snooping Database**, as shown below:

Figure 9-39 DHCP Snooping Database window

The fields that can be configured for **DHCP Snooping Database** are described below:

Parameter	Description
Write Delay	Enter the write delay time value here. This value must be between 60 and 86400 seconds. By default, this value is 300 seconds.

Click the **Reset** button to reset the information entered.

Click the **Apply** button to accept the changes made.

The fields that can be configured for **Store DHCP Snooping Database** are described below:

Parameter	Description
URL	Select the location from the drop-down list and enter the URL where the DHCP snooping database will be stored to here. Location to choose from is TFTP .

Click the **Apply** button to accept the changes made.

The fields that can be configured for **Load DHCP Snooping Database** are described below:

Parameter	Description
URL	Select the location from the drop-down list and enter the URL where the DHCP snooping database will be loaded from here. Location to choose from is TFTP .

Click the **Apply** button to accept the changes made.

Click the **Clear** button to clear all the counter information.

DHCP Snooping Binding Entry

This window is used to view and configure the DHCP snooping binding entries.

To view the following window, click **Security > IMPB > IPv4 > DHCPv4 Snooping > DHCP Snooping Binding Entry**, as shown below:

Figure 9-40 DHCP Snooping Binding Entry window

The fields that can be configured are described below:

Parameter	Description
MAC Address	Enter the MAC address of the DHCP snooping binding entry here.
VID	Enter the VLAN ID of the DHCP snooping binding entry here. This value must be between 1 and 4094.
IP Address	Enter the IP address of the DHCP snooping binding entry here.
Unit	Select the switch unit that will be used for this configuration here.
Port	Select the appropriate port used for the configuration here.
Expiry	Enter the expiry time value used here. This value must be between 60 and 4294967295 seconds.

Click the **Add** button to add a new entry based on the information entered.

Click the **Delete** button to remove the specified entry.

Enter a page number and click the **Go** button to navigate to a specific page when multiple pages exist.

Dynamic ARP Inspection

ARP Access List

This window is used to view and configure the dynamic ARP inspection settings.

To view the following window, click **Security > IMPB > IPv4 > Dynamic ARP Inspection > ARP Access List**, as shown below:

Figure 9-41 ARP Access List window

The fields that can be configured are described below:

Parameter	Description
ARP Access List Name	Enter the ARP access list name used here. This name can be up to 32 characters long.

Click the **Add** button to add a new entry based on the information entered.

Click the **Edit** button to re-configure the specific entry.

Click the **Delete** button to remove the specified entry.

After clicking the **Edit** button, the following window will appear.

ARP Access List

Action:

IP: Sender IP:

MAC: Sender MAC:

Sender IP Mask: Sender MAC Mask:

ARP Access List Name: ARP-Access-List

Total Entries: 1

Action	IP Type	Sender IP	Sender IP Mask	MAC Type	Sender MAC	Sender MAC Mask	
Permit	Any	-	-	Any	-	-	Delete

Figure 9-42 ARP Access List - Edit window

The fields that can be configured are described below:

Parameter	Description
Action	Select the action that will be taken here. Options to choose from are Permit and Deny .
IP	Select the type of sender IP address that will be used here. Options to choose from are Any , Host , and IP with Mask .
Sender IP	After selecting the Host or IP with Mask options as the type of IP , enter the sender IP address used here.
Sender IP Mask	After selecting the IP with Mask option as the type of IP , enter the sender IP mask used here.
MAC	Select the type of sender MAC address that will be used here. Options to choose from are Any , Host , and MAC with Mask .
Sender MAC	After selecting the Host or MAC with Mask options as the type of MAC , enter the sender MAC address used here.
Sender MAC Mask	After selecting the MAC with Mask option as the type of MAC , enter the sender MAC mask used here.

Click the **Back** button to return to the previous page.

Click the **Apply** button to accept the changes made.

Click the **Delete** button to remove the specified entry.

ARP Inspection Settings

This window is used to view and configure the ARP inspection settings.

To view the following window, click **Security > IMPB > IPv4 > Dynamic ARP Inspection > ARP Inspection Settings**, as shown below:

Figure 9-43 ARP Inspection Settings window

The fields that can be configured for **ARP Inspection Validation** are described below:

Parameter	Description
Src-MAC	Select to enable or disable the source MAC option here. This option specifies to check for ARP requests and response packets and the consistency of the source MAC address in the Ethernet header against the sender MAC address in the ARP payload.
Dst-MAC	Select to enable or disable the destination MAC option here. This option specifies to check for ARP response packets and the consistency of the destination MAC address in the Ethernet header against the target MAC address in the ARP payload.
IP	Select to enable or disable the IP option here. This option specifies to check the ARP body for invalid and unexpected IP addresses. It also specifies to check the validity of IP address in the ARP payload. The sender IP in both the ARP request and response and target IP in the ARP response are validated. Packets destined for the IP addresses 0.0.0.0, 255.255.255.255, and all IP multicast addresses are dropped. Sender IP addresses are checked in all ARP requests and responses, and target IP addresses are checked only in ARP responses.

Click the **Apply** button to accept the changes made.

The fields that can be configured for **ARP Inspection Filter** are described below:

Parameter	Description
ARP Access List Name	Enter the ARP access list name used here. This name can be up to 32 characters long.
VID List	Enter the VLAN ID list used here.

Static ACL	Select whether to use a static ACL or not here by either selecting Yes or No .
-------------------	--

Click the **Add** button to add a new entry based on the information entered.

Click the **Delete** button to remove an entry based on the information entered.

Enter a page number and click the **Go** button to navigate to a specific page when multiple pages exist.

ARP Inspection Port Settings

This window is used to view and configure the ARP inspection port settings.

To view the following window, click **Security > IMPB > IPv4 > Dynamic ARP Inspection > ARP Inspection Port Settings**, as shown below:

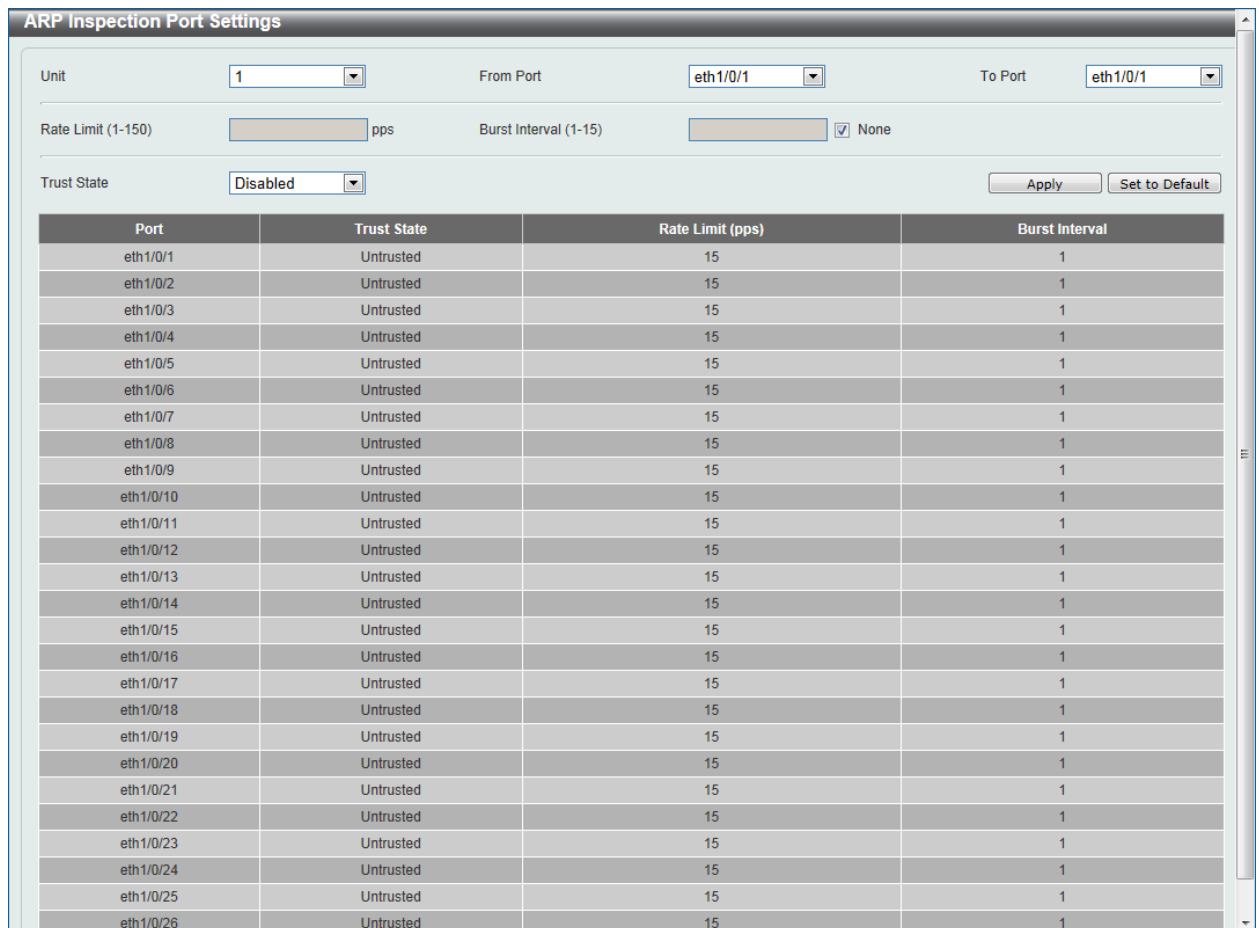

Figure 9-44 ARP Inspection Port Settings window

The fields that can be configured are described below:

Parameter	Description
Unit	Select the switch unit that will be used for this configuration here.
From Port / To Port	Select the appropriate port range used for the configuration here.
Rate Limit	Enter the rate limit value here. This value must be between 1 and 150 packets per seconds.
Burst Interval	Enter the burst interval value here. This value must be between 1 and

	15. Tick the None option to disable the option.
Trust State	Select to enable or disable the trust state here.

Click the **Apply** button to accept the changes made.

Click the **Set to Default** button to change the information to the default values.

ARP Inspection VLAN

This window is used to view and configure the ARP inspection VLAN settings.

To view the following window, click **Security > IMPB > IPv4 > Dynamic ARP Inspection > ARP Inspection VLAN**, as shown below:

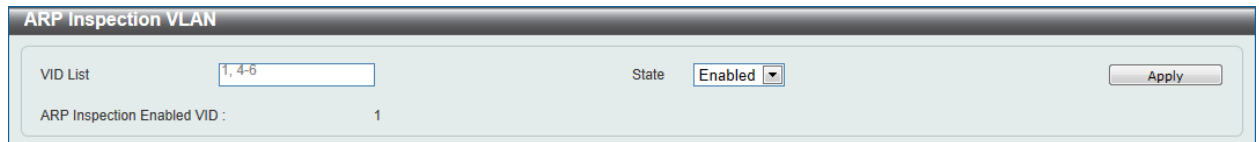

Figure 9-45 ARP Inspection VLAN window

The fields that can be configured are described below:

Parameter	Description
VID List	Enter the VLAN ID list used here.
State	Select to enable or disable the ARP inspection option's state for the specified VLAN here.

Click the **Apply** button to accept the changes made.

ARP Inspection Statistics

This window is used to view and clear the ARP inspection statistics information.

To view the following window, click **Security > IMPB > IPv4 > Dynamic ARP Inspection > ARP Inspection Statistics**, as shown below:

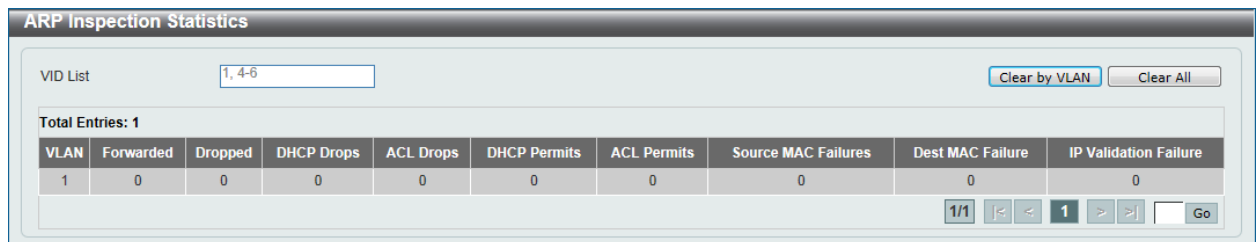

Figure 9-46 ARP Inspection Statistics window

The fields that can be configured are described below:

Parameter	Description
VID List	Enter the VLAN ID list used here.

Click the **Clear by VLAN** button to clear the information based on the VLAN ID(s) entered.

Click the **Clear All** button to clear all the information in this table.

Enter a page number and click the **Go** button to navigate to a specific page when multiple pages exist.

ARP Inspection Log

This window is used to view, configure and clear the ARP inspection log information.

To view the following window, click **Security > IMPB > IPv4 > Dynamic ARP Inspection > ARP Inspection Log**, as shown below:

Figure 9-47 ARP Inspection Log window

The fields that can be configured are described below:

Parameter	Description
Log Buffer	Enter the log's buffer value used here. This value must be between 1 and 1024. By default, this value is 32.

Click the **Apply** button to accept the changes made.

Click the **Clear Log** button to clear the log.

IP Source Guard

IP Source Guard Port Settings

This window is used to view and configure the IP source guard port settings.

To view the following window, click **Security > IMPB > IPv4 > IP Source Guard > IP Source Guard Port Settings**, as shown below:

Figure 9-48 IP Source Guard Port Settings window

The fields that can be configured are described below:

Parameter	Description
Unit	Select the switch unit that will be used for this configuration here.
From Port / To Port	Select the appropriate port range used for the configuration here.
State	Select to enable or disable the IP source guard's state for the specified

	port(s) here.
Validation	Select the validation method used here. Options to choose from are IP and IP-MAC . Selecting IP means that the IP address of the received packets will be checked. Selecting IP-MAC means that the IP address and the MAC address of the received packets will be checked.

Click the **Apply** button to accept the changes made.

IP Source Guard Binding

This window is used to view and configure the IP source guard binding settings.

To view the following window, click **Security > IMPB > IPv4 > IP Source Guard > IP Source Guard Binding**, as shown below:

Figure 9-49 IP Source Guard Binding window

The fields that can be configured for **IP Source Binding Settings** are described below:

Parameter	Description
MAC Address	Enter the MAC address of the binding entry here.
VID	Enter the VLAN ID of the binding entry here.
IP Address	Enter the IP address of the binding entry here.
Unit	Select the switch unit that will be used for this configuration here.
From Port / To Port	Select the appropriate port range used for the configuration here.

Click the **Apply** button to accept the changes made.

The fields that can be configured for **IP Source Binding Entry** are described below:

Parameter	Description
Unit	Select the switch unit that will be used for this query here.
From Port / To Port	Select the appropriate port range used for the query here.

IP Address	Enter the IP address of the binding entry here.
MAC Address	Enter the MAC address of the binding entry here.
VID	Enter the VLAN ID of the binding entry here.
Type	Select the type of binding entry to find here. Options to choose from are All , DHCP Snooping , and Static . Selecting All specifies that all the DHCP binding entries will be displayed. Selecting DHCP Snooping specifies to display the IP-source guard binding entry learned by DHCP binding snooping. Selecting Static specifies to display the IP-source guard binding entry that is manually configured.

Click the **Find** button to locate a specific entry based on the information entered.

Click the **Delete** button to remove the specified entry.

Enter a page number and click the **Go** button to navigate to a specific page when multiple pages exist.

IP Source Guard HW Entry

This window is used to view the IP source guard hardware entries.

To view the following window, click **Security > IMPB > IPv4 > IP Source Guard > IP Source Guard HW Entry**, as shown below:

Figure 9-50 IP Source Guard HW Entry window

The fields that can be configured are described below:

Parameter	Description
Unit	Select the switch unit that will be used for this query here.
From Port / To Port	Select the appropriate port range used for the query here.

Click the **Find** button to locate a specific entry based on the information entered.

Enter a page number and click the **Go** button to navigate to a specific page when multiple pages exist.

Advanced Settings

IP-MAC-Port Binding Settings

This window is used to view and configure the IP-MAC-Port binding settings.

To view the following window, click **Security > IMPB > IPv4 > Advanced Settings > IP-MAC-Port Binding Settings**, as shown below:

IP-MAC-Port Binding Settings

IP-MAC-Port Binding Trap Settings

Trap State Enabled Disabled Apply

IP-MAC-Port Binding Port Settings

Unit From Port To Port Mode Apply

Port	Mode
eth1/0/1	Disabled
eth1/0/2	Disabled
eth1/0/3	Disabled
eth1/0/4	Disabled
eth1/0/5	Disabled
eth1/0/6	Disabled
eth1/0/7	Disabled
eth1/0/8	Disabled
eth1/0/9	Disabled
eth1/0/10	Disabled
eth1/0/11	Disabled
eth1/0/12	Disabled
eth1/0/13	Disabled
eth1/0/14	Disabled
eth1/0/15	Disabled
eth1/0/16	Disabled
eth1/0/17	Disabled
eth1/0/18	Disabled
eth1/0/19	Disabled
eth1/0/20	Disabled
eth1/0/21	Disabled
eth1/0/22	Disabled
eth1/0/23	Disabled
eth1/0/24	Disabled

Figure 9-51 IP-MAC-Port Binding Settings window

The fields that can be configured for **IP-MAC-Port Binding Trap Settings** are described below:

Parameter	Description
Trap State	Select the enable or disable the IP-MAC-Port binding option's trap state.

Click the **Apply** button to accept the changes made.

The fields that can be configured for **IP-MAC-Port Binding Port Settings** are described below:

Parameter	Description
Unit	Select the switch unit that will be used for this configuration here.
From Port / To Port	Select the appropriate port range used for the configuration here.
Mode	Select the mode of access control that will be used here. Options to choose from are Disabled , Strict , and Loose . When a port is enabled for IMPB strict-mode access control, a host can only access the port after the host sends ARP or IP packets and the ARP packet or IP packet sent by the host passes the binding check. To pass the binding check, the source IP address, source MAC address, VLAN ID, and arrival port number must match any of the entries defined by either the IP source guard static binding entry or the DHCP snooping learned dynamic binding entry. When a port is enabled for IMPB loose-mode access control, a host will be denied to access the port after the host sends ARP or IP packets and the ARP packet or IP packet sent by the host does not pass the binding check. To pass the binding check, the

source IP address, source MAC address, VLAN ID, and arrival port must match any of the entries defined by either the IP source guard static binding entry or the DHCP snooping learned dynamic binding entry.

Click the **Apply** button to accept the changes made.

IP-MAC-Port Binding Blocked Entry

This window is used to view and clear the IP-MAC-Port binding blocked entry table.

To view the following window, click **Security > IMPB > IPv4 > Advanced Settings > IP-MAC-Port Binding Blocked Entry**, as shown below:

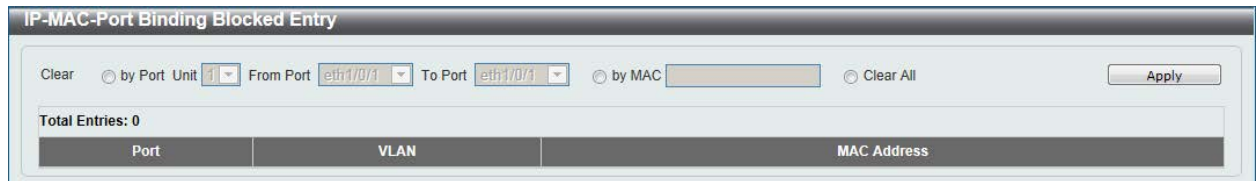

Figure 9-52 IP-MAC-Port Binding Blocked Entry window

The fields that can be configured are described below:

Parameter	Description
Clear by Port	Select this option to clear the entry table based on the port(s) selected.
Unit	Select the switch unit that will be clear here.
From Port / To Port	Select the appropriate port range that will be cleared here.
Clear by MAC	Select this option to clear the entry table based on the MAC address entered. Enter the MAC address that will be cleared in the space provided.
Clear All	Select this option to clear all entries that contain MAC addresses.

Click the **Apply** button to accept the changes made.

IPv6

IPv6 Snooping

This window is used to view and configure the IPv6 snooping settings.

To view the following window, click **Security > IMPB > IPv6 > IPv6 Snooping**, as shown below:

Figure 9-53 IPv6 Snooping window

The fields that can be configured for **Station Move Setting** are described below:

Parameter	Description
Station Move	Select the station move options here. Options to choose from are Permit and Deny .

Click the **Apply** button to accept the changes made.

The fields that can be configured for **IPv6 Snooping Policy Settings** are described below:

Parameter	Description
Policy Name	Enter the IPv6 snooping policy name used here. This name can be up to 32 characters long.
Limit Address Count	Enter the address count limit value used here. This value must be between 0 and 511. Tick the No Limit option to disable this option.
Protocol	Select the protocol that will be associated with this policy here. Options to choose from are Disabled , DHCP , NDP , and All . DHCPv6 Snooping sniffs the DHCPv6 packets sent between the DHCPv6 client and server in the address assigning procedure. When a DHCPv6 client successfully got a valid IPv6 address, DHCPv6 snooping creates its binding database. ND Snooping is designed for a stateless auto-configuration assigned IPv6 address and manually configured IPv6 address. Before assigning an IPv6 address, the host must perform Duplicate Address Detection first. ND snooping detects DAD messages (DAD NS and DAD NA) to build its binding database. The NDP packet (NS and NA) is also used to detect whether a host is still reachable and determine whether to delete a binding or not.
VID List	Enter the VLAN ID list used here.

Click the **Apply** button to accept the changes made.

Click the **Edit** button to re-configure the specific entry.

Click the **Delete** button to remove the specified entry.

IPv6 ND Inspection

This window is used to view and configure the IPv6 ND inspection settings.

To view the following window, click **Security > IMPB > IPv6 > IPv6 ND Inspection**, as shown below:

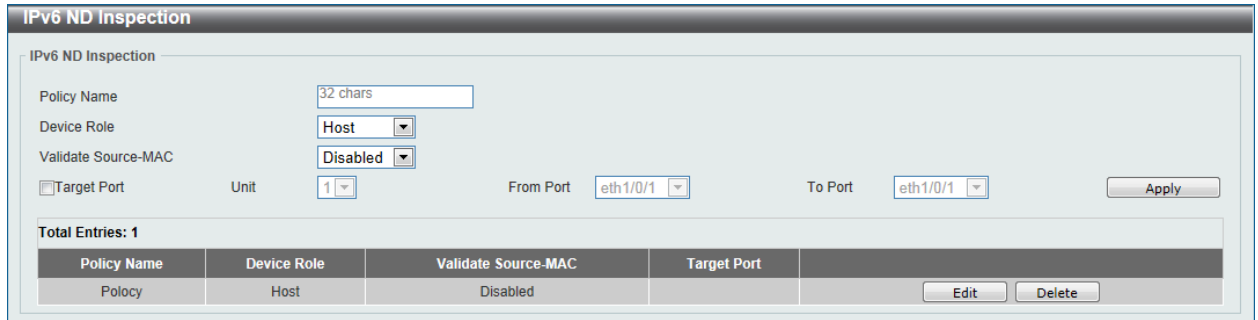

Figure 9-54 IPv6 ND Inspection window

The fields that can be configured are described below:

Parameter	Description
Policy Name	Enter the policy name used here. This name can be up to 32 characters long.
Device Role	Select the device role here. Options to choose from are Host and Router . By default, the device's role is set as host and inspection for NS and NA messages are performed. If the device role is set as router, the NS and NA inspection is not performed. When performing NS/NA inspection, the message will be verified against the dynamic binding table learned from the ND protocol or from the DHCP.
Validate Source-MAC	Select to enable or disable the validation of the source MAC address option here. When the Switch receives an ND message that contains a link-layer address, the source MAC address is checked against the link-layer address. The packet will be dropped if the link-layer address and the MAC addresses are different from each other.
Target Port	Tick this option to specify the target port.
Unit	Select the switch unit that will be used for this configuration here.
From Port / To Port	Select the appropriate port range used for the configuration here.

Click the **Apply** button to accept the changes made.

Click the **Edit** button to re-configure the specific entry.

Click the **Delete** button to remove the specified entry.

IPv6 RA Guard

This window is used to view and configure the IPv6 Router Advertisement (RA) guard settings.

To view the following window, click **Security > IMPB > IPv6 > IPv6 RA Guard**, as shown below:



Figure 9-55 IPv6 RA Guard window

The fields that can be configured are described below:

Parameter	Description
Policy Name	Enter the policy name here. This name can be up to 32 characters long.
Device Role	Select the device role here. Options to choose from are Host and Router . By default, the device's role is Host , which will block all the RA packets. If the device's role is Router , RA packets will be forwarded according to the port's bound ACL.
Match IPv6 Access List	Enter or select the IPv6 access list to match here.
Target Port	Tick this option to specify the target port.
Unit	Select the switch unit that will be used for this configuration here.
From Port / To Port	Select the appropriate port range used for the configuration here.

Click the **Apply** button to accept the changes made.

Click the **Edit** button to re-configure the specific entry.

Click the **Delete** button to remove the specified entry.

IPv6 DHCP Guard

This window is used to view and configure the IPv6 DHCP guard settings.

To view the following window, click **Security > IMPB > IPv6 > IPv6 DHCP Guard**, as shown below:

Figure 9-56 IPv6 DHCP Guard window

The fields that can be configured are described below:

Parameter	Description
Policy Name	Enter the policy name here. This name can be up to 32 characters long.
Device Role	Select the device role here. Options to choose from are Client and Server . By default, the device's role is set as Client , which will block all the DHCPv6 packets from the DHCPv6 Server. If the device's role is set as Server , DHCPv6 Server packets will be forwarded according to the port's bound ACL.
Match IPv6 Access List	Enter or select the IPv6 access list to match here.

Target Port	Tick this option to specify the target port.
Unit	Select the switch unit that will be used for this configuration here.
From Port / To Port	Select the appropriate port range used for the configuration here.

Click the **Apply** button to accept the changes made.

Click the **Edit** button to re-configure the specific entry.

Click the **Delete** button to remove the specified entry.

IPv6 Source Guard

IPv6 Source Guard Settings

This window is used to view and configure the IPv6 source guard settings.

To view the following window, click **Security > IMPB > IPv6 > IPv6 Source Guard > IPv6 Source Guard Settings**, as shown below:

Figure 9-57 IPv6 Source Guard Settings window

The fields that can be configured are described below:

Parameter	Description
Policy Name	Enter the policy name here. This name can be up to 32 characters long.
Global Auto-Configure Address	Select to permit or deny data traffic from the auto-configured global address. It is useful when all global addresses on a link are assigned by DHCP and the administrator that wants to block hosts with self-configured addresses from sending traffic.
Link Local Traffic	Select to permit or deny hardware permitted data traffic sent by the link-local address.
Target Port	Tick this option to specify the target port.
Unit	Select the switch unit that will be used for this configuration here.
From Port / To Port	Select the appropriate port range used for the configuration here.

Click the **Apply** button to accept the changes made.

Click the **Edit** button to re-configure the specific entry.

Click the **Delete** button to remove the specified entry.

IPv6 Neighbor Binding

This window is used to view and configure the IPv6 neighbor binding settings.

To view the following window, click **Security > IMPB > IPv6 > IPv6 Source Guard > IPv6 Neighbor Binding**, as shown below:

Figure 9-58 IPv6 Neighbor Binding window

The fields that can be configured for **IPv6 Neighbor Binding Settings** are described below:

Parameter	Description
MAC Address	Enter the MAC address used here.
VID	Enter the VLAN ID used here. This value must be between 1 and 4094.
IPv6 Address	Enter the IPv6 address used here.
Unit	Select the switch unit that will be used for this configuration here.
From Port / To Port	Select the appropriate port range used for the configuration here.

Click the **Apply** button to accept the changes made.

The fields that can be configured for **IPv6 Neighbor Binding Entry** are described below:

Parameter	Description
Unit	Select the switch unit that will be used for this search here.
From Port / To Port	Select the appropriate port range used for the search here.
IPv6 Address	Enter the IPv6 address to find here.
MAC Address	Enter the MAC address to find here.
VID	Enter the VLAN ID to find here.

Click the **Find** button to locate a specific entry based on the information entered.

Click the **Delete** button to remove the specified entry.

DHCP Server Screening

This function allows users to not only to restrict all DHCP server packets but also to receive any specified DHCP server packet by any specified DHCP client. It is useful when one or more DHCP servers are present on the network and both provide DHCP services to different distinct groups of clients.

The first time the DHCP filter is enabled it will create both an access profile entry and an access rule per port entry, it will also create other access rules. These rules are used to block all DHCP server packets. In addition to a permit DHCP entry it will also create one access profile and one access rule entry the first time the DHCP client MAC address is used as the client MAC address. The Source IP address is the same as the DHCP server's IP address (UDP port number 67). These rules are used to permit the DHCP server packets with specific fields, which the user has configured.

When DHCP Server filter function is enabled all DHCP Server packets will be filtered from a specific port.

DHCP Server Screening Global Settings

This window is used to view and configure the DHCP server screening global settings.

To view the following window, click **Security > DHCP Server Screening > DHCP Server Screening Global Settings**, as shown below:

Figure 9-59 DHCP Server Screening Global Settings window

The fields that can be configured for **Trap Settings** are described below:

Parameter	Description
Trap State	Select to enable or disable the DHCP server screening trap here.

Click the **Apply** button to accept the changes made.

The fields that can be configured for **Profile Settings** are described below:

Parameter	Description
Profile Name	Enter the DHCP server screening profile name here. This name can be up to 32 characters long.
Client MAC	Enter the MAC address used here.

Click the **Apply** button to accept the changes made.

Click the **Delete** button to remove the specified entry.

Click the **Delete Profile** button to remove the specified profile.

The fields that can be configured for **Log Information** are described below:

Parameter	Description
Log Buffer Entries	Enter the logged buffer entries value here. This value must be between 10 and 1024. By default, this value is 32.

Click the **Apply** button to accept the changes made.

Click the **Clear Log** button to clear the log.

DHCP Server Screening Port Settings

This window is used to view and configure the DHCP server screening port settings.

To view the following window, click **Security > DHCP Server Screening > DHCP Server Screening Port Settings**, as shown below:

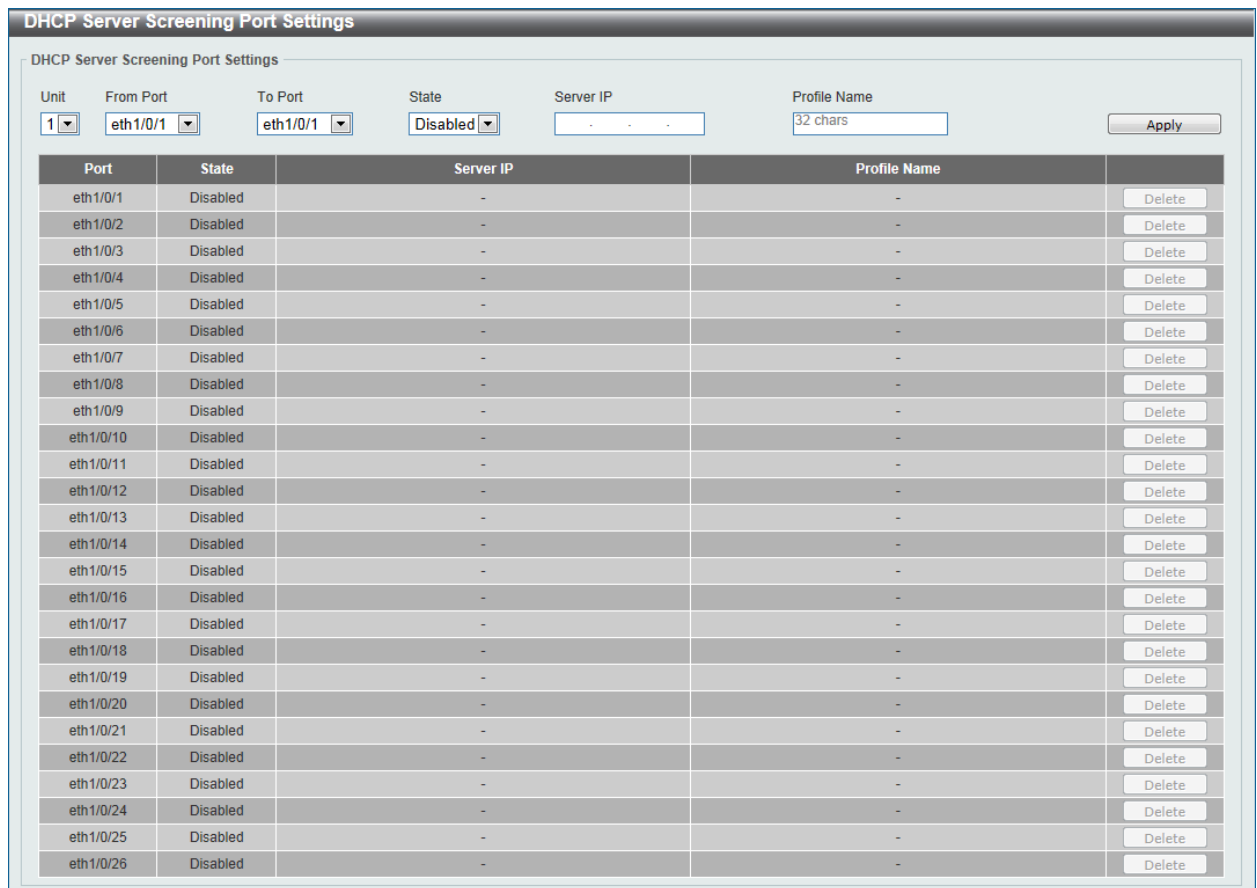

Figure 9-60 DHCP Server Screening Port Settings window

The fields that can be configured are described below:

Parameter	Description
Unit	Select the switch unit that will be used for this configuration here.
From Port / To Port	Select the appropriate port range used for the configuration here.

State	Select to enable or disable the DHCP server screening function on the port(s) specified.
Server IP	Enter the DHCP server's IP address here.
Profile Name	Enter the DHCP server screening profile that will be used for the port(s) specified here.

Click the **Apply** button to accept the changes made.

Click the **Delete** button to remove the specified entry.

ARP Spoofing Prevention

This window is used to view and configure the ARP spoofing prevention settings. When an entry is created, ARP packets whose sender IP address matches the gateway IP address, of an entry, but its sender MAC address field does not match the gateway MAC address, of the entry, will be dropped by the system. The ASP will bypass the ARP packets whose sender IP address doesn't match the configured gateway IP address.

If an ARP address matches a configured gateway's IP address, MAC address, and port list, then bypass the Dynamic ARP Inspection (DAI) check no matter if the receiving port is ARP trusted or untrusted.

To view the following window, click **Security > ARP Spoofing Prevention**, as shown below:

Figure 9-61 ARP Spoofing Prevention window

The fields that can be configured are described below:

Parameter	Description
Unit	Select the switch unit that will be used for this configuration here.
From Port / To Port	Select the appropriate port range used for the configuration here.
Gateway IP	Enter the gateway's IP address used here.
Gateway MAC	Enter the gateway's MAC address used here.

Click the **Apply** button to accept the changes made.

Click the **Delete** button to remove the specified entry.

BPDU Attack Protection

This window is used to view and configure the BPDU attack protection settings. In generally, there are two states in the BPDU attack protection function. One is normal state, and another is under attack state.

The under attack state have three modes: drop, block, and shutdown. A BPDU protection enabled port will enter an under attack state when it receives one STP BPDU packet and it will take action based on the configuration. Thus, BPDU protection can only be enabled on the STP-disabled port.

BPDU protection has a higher priority than the FBPDU setting configured by configure STP command in the determination of BPDU handling. That is, when FBPDU is configured to forward STP BPDU but BPDU protection is enabled, then the port will not forward STP BPDU.

BPDU protection also has a higher priority than the BPDU tunnel port setting in determination of BPDU handling. That is, when a port is configured as BPDU tunnel port for STP, it will forward STP BPDU. But if the port is BPDU protection enabled. Then the port will not forward STP BPDU.

To view the following window, click **Security > BPDU Attack Protection**, as shown below:

BPDU Attack Protection

BPDU Attack Protection Global Settings

BPDU Attack Protection State Enabled Disabled Apply

BPDU Attack Protection Trap State Enabled Disabled

BPDU Attack Protection Port Settings

Unit: From Port: To Port: State: Mode: Apply

Unit 1 Settings

Port	State	Mode	Status
eth1/0/1	Disabled	Shutdown	Normal
eth1/0/2	Disabled	Shutdown	Normal
eth1/0/3	Disabled	Shutdown	Normal
eth1/0/4	Disabled	Shutdown	Normal
eth1/0/5	Disabled	Shutdown	Normal
eth1/0/6	Disabled	Shutdown	Normal
eth1/0/7	Disabled	Shutdown	Normal
eth1/0/8	Disabled	Shutdown	Normal
eth1/0/9	Disabled	Shutdown	Normal
eth1/0/10	Disabled	Shutdown	Normal

Figure 9-62 BPDU Attack Protection window

The fields that can be configured are described below:

Parameter	Description
BPDU Attack Protection State	Select to enable or disable the BPDU attack protection feature's global state here.
BPDU Attack Protection Trap State	Select to enable or disable the BPDU attack protection feature's trap state here.
Unit	Select the switch unit that will be used for this configuration here.
From Port / To Port	Select the appropriate port range used for the configuration here.
State	Select to enable or disable the BPDU attack protection feature's state on the port(s) specified.
Mode	Select the BPDU attack protection feature's mode that will be applied to the port(s) specified. Options to choose from are Drop , Block and Shutdown . <i>Drop</i> – Drop all received BPDU packets when the port enters under attack state. <i>Block</i> – Drop all packets (include BPDU and normal packets) when the port enters under attack state.

	<i>Shutdown</i> – Shut down the port when the port enters under attack state.
--	---

Click the **Apply** button to accept the changes made.

MAC Authentication

This window is used to view and configure the MAC authentication settings. MAC authentication is a feature designed to authenticate a user by MAC address when the user is trying to access the network via the Switch. The Switch itself can perform the authentication based on a local database or be a RADIUS client and perform the authentication process via the RADIUS protocol with a remote RADIUS server.

To view the following window, click **Security > MAC Authentication**, as shown below:

Figure 9-63 Port Security Global Settings window

The fields that can be configured for **MAC Authentication Global Settings** are described below:

Parameter	Description
MAC Authentication State	Select to enable or disable the MAC authentication feature's global state.
MAC Authentication Trap State	Select to enable or disable the MAC authentication feature's trap state.

Click the **Apply** button to accept the changes made.

The fields that can be configured for **MAC Authentication User Name and Password Settings** are described below:

Parameter	Description
User Name	Enter the username used for MAC authentication here. This name can be up to 16 characters long. Tick the Default option to restore the username to the client's MAC address here.
Password	Enter the password used for MAC authentication here. Tick the Encrypt option save this password in the encrypted form. Tick the Default option to restore the password to the client's MAC address here.

Click the **Apply** button to accept the changes made.

The fields that can be configured for **MAC Authentication Port Settings** are described below:

Parameter	Description
Unit	Select the switch unit that will be used for this configuration here.
From Port / To Port	Select the appropriate port range used for the configuration here.
State	Select to enable or disable MAC authentication for the port(s) specified here.

Click the **Apply** button to accept the changes made.

Web-based Access Control

Web-based Access Control (WAC) is a feature designed to authenticate a user when the user is trying to access the Internet via the Switch. The authentication process uses the HTTP or HTTPS protocol. The Switch enters the authenticating stage when users attempt to browse Web pages (e.g., <http://www.dlink.com>) through a Web browser. When the Switch detects HTTP or HTTPS packets and this port is unauthenticated, the Switch will launch a pop-up user name and password window to query users. Users are not able to access the Internet until the authentication process is passed.

The Switch can be the authentication server itself and do the authentication based on a local database, or be a RADIUS client and perform the authentication process via the RADIUS protocol with a remote RADIUS server. The client user initiates the authentication process of WAC by attempting to gain Web access.

D-Link's implementation of WAC uses a virtual IP that is exclusively used by the WAC function and is not known by any other modules of the Switch. In fact, to avoid affecting a Switch's other features, WAC will only use a virtual IP address to communicate with hosts. Thus, all authentication requests must be sent to a virtual IP address but not to the IP address of the Switch's physical interface.

Virtual IP works like this, when a host PC communicates with the WAC Switch through a virtual IP, the virtual IP is transformed into the physical IPIF (IP interface) address of the Switch to make the communication possible. The host PC and other servers' IP configurations do not depend on the virtual IP of WAC. The virtual IP does not respond to any ICMP packets or ARP requests, which means it is not allowed to configure a virtual IP on the same subnet as the Switch's IPIF (IP interface) or the same subnet as the host PCs' subnet.

As all packets to a virtual IP from authenticated and authenticating hosts will be trapped to the Switch's CPU, if the virtual IP is the same as other servers or PCs, the hosts on the WAC-enabled ports cannot communicate with the server or PC which really own the IP address. If the hosts need to access the server or PC, the virtual IP cannot be the same as the one of the server or PC. If a host PC uses a proxy to access the Web, to make the authentication work properly the user of the PC should add the virtual IP to the exception of the proxy configuration. Whether or not a virtual IP is specified, users can access the

WAC pages through the Switch's system IP. When a virtual IP is not specified, the authenticating Web request will be redirected to the Switch's system IP.

The Switch's implementation of WAC features a user-defined port number that allows the configuration of the TCP port for either the HTTP or HTTPS protocols. This TCP port for HTTP or HTTPS is used to identify the HTTP or HTTPS packets that will be trapped to the CPU for authentication processing, or to access the login page. If not specified, the default port number for HTTP is 80 and the default port number for HTTPS is 443. If no protocol is specified, the default protocol is HTTP.

The following diagram illustrates the basic six steps all parties go through in a successful Web Authentication process:

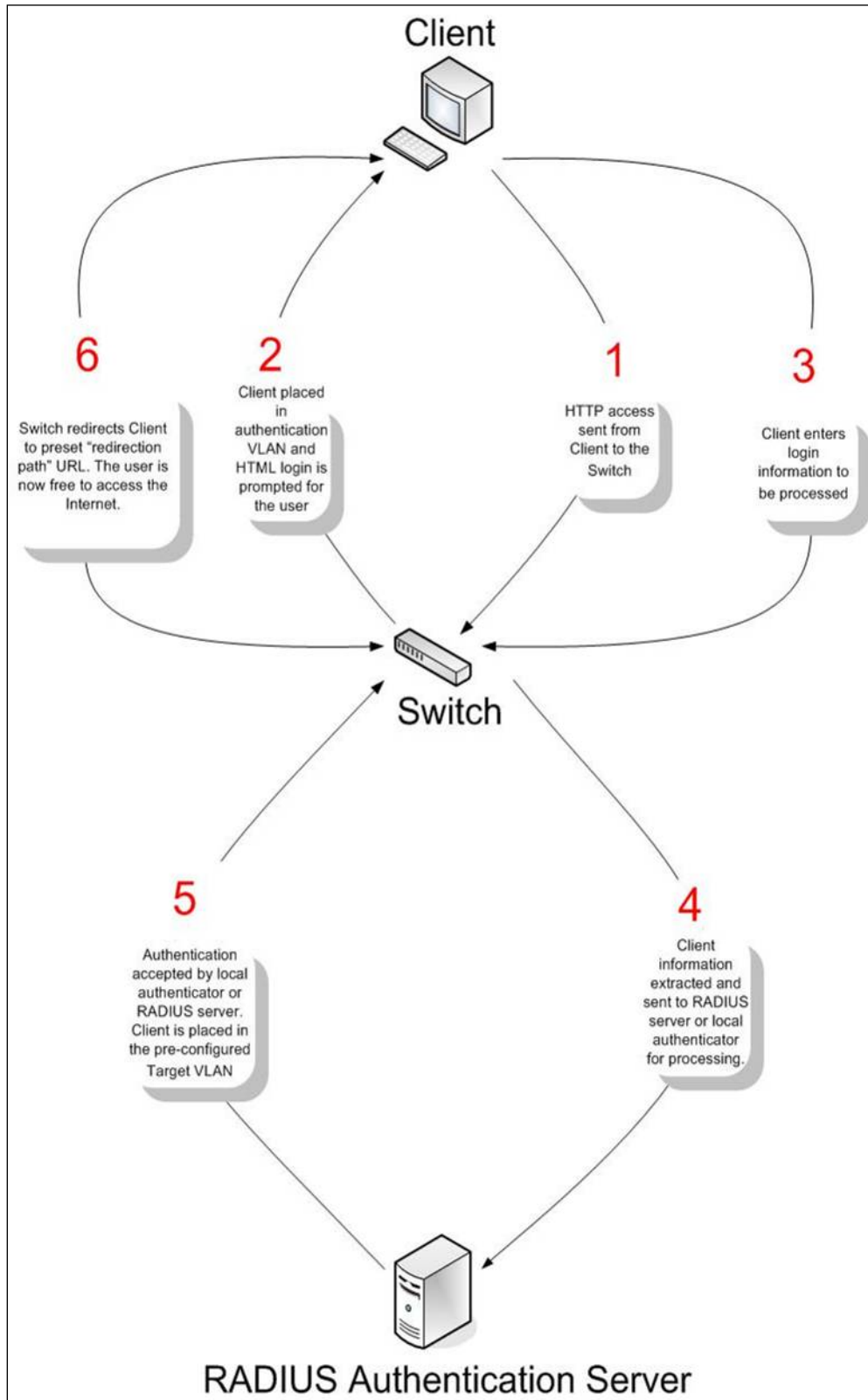

Figure 9-64 RADIUS Authentication Server

Conditions and Limitations

- If the client is utilizing DHCP to attain an IP address, the authenticating VLAN must provide a DHCP server or a DHCP relay function so that client may obtain an IP address.

- Certain functions exist on the Switch that will filter HTTP packets, such as the Access Profile function. The user needs to be very careful when setting filter functions for the target VLAN, so that these HTTP packets are not denied by the Switch.
- If a RADIUS server is to be used for authentication, the user must first establish a RADIUS Server with the appropriate parameters, including the target VLAN, before enabling Web Authentication on the Switch.

Web Authentication

This window is used to view and configure the Web authentication settings.

To view the following window, click **Security > Web-based Access Control > Web Authentication**, as shown below:

Figure 9-65 Port Security Global Settings window

The fields that can be configured are described below:

Parameter	Description
Web Authentication State	Select to enable or disable the Web authentication feature's global state.
Trap State	Select to enable or disable the Web authentication feature's trap state.
Virtual IPv4	Enter the virtual IPv4 address used here. The virtual IP of Web authentication is just the characterization of the Web authentication function on the Switch. All Web authentication processes communicate with this IP address, however, the virtual IP does not respond to any ICMP packet or ARP request. So it's not allowed to configure virtual IP in the same subnet as the Switch's IP interface or the same subnet as the host PCs' subnet, otherwise the Web authentication cannot operate correctly. The defined URL only takes effect when the virtual IP address is configured. The users get the FQDN URL stored on the DNS server to get the virtual IP address. The obtained IP address must match the virtual IP address configured by the command. If the IPv4 virtual IP is not configured, the IPv4 access cannot start a Web authentication.
Virtual IPv6	Enter the virtual IPv6 address used here. If the IPv6 virtual IP is not configured, the IPv6 access cannot start a Web authentication.
Virtual URL	Enter the virtual URL used here. This URL can be up to 128 characters long.
Redirection Path	Enter the redirection path here. This path can be up to 128 characters long.

Click the **Apply** button to accept the changes made.

WAC Port Settings

This window is used to view and configure the WAC port settings.

To view the following window, click **Security > Web-based Access Control > WAC Port Settings**, as shown below:

Unit	From Port	To Port	State
1	eth1/0/1	eth1/0/1	Disabled
Apply			
Port	State		
eth1/0/1	Disabled		
eth1/0/2	Disabled		
eth1/0/3	Disabled		
eth1/0/4	Disabled		
eth1/0/5	Disabled		
eth1/0/6	Disabled		
eth1/0/7	Disabled		
eth1/0/8	Disabled		
eth1/0/9	Disabled		
eth1/0/10	Disabled		
eth1/0/11	Disabled		
eth1/0/12	Disabled		
eth1/0/13	Disabled		
eth1/0/14	Disabled		
eth1/0/15	Disabled		
eth1/0/16	Disabled		
eth1/0/17	Disabled		
eth1/0/18	Disabled		
eth1/0/19	Disabled		
eth1/0/20	Disabled		
eth1/0/21	Disabled		
eth1/0/22	Disabled		
eth1/0/23	Disabled		
eth1/0/24	Disabled		
eth1/0/25	Disabled		
eth1/0/26	Disabled		

Figure 9-66 WAC Port Settings window

The fields that can be configured are described below:

Parameter	Description
Unit	Select the switch unit that will be used for this configuration here.
From Port / To Port	Select the appropriate port range used for the configuration here.
State	Select to enable or disable the WAC feature on the port(s) specified.

Click the **Apply** button to accept the changes made.

WAC Customize Page

This window is used to view and configure the WAC customized login page.

To view the following window, click **Security > Web-based Access Control > WAC Customize Page**, as shown below:

Figure 9-67 WAC Customize Page window

The fields that can be configured are described below:

Parameter	Description
Page Title	Enter a custom page title message here. This message can be up to 128 characters long.
Login window Title	Enter a custom login window title here. This title can be up to 64 characters long.
User Name Title	Enter a custom username title here. This title can be up to 32 characters long.
Password Title	Enter a custom password title here. This title can be up to 32 characters long.
Logout window Title	Enter a custom logout window title here. This title can be up to 64 characters long.
Notification	Enter additional information to display in the notification area here. This information can be up to 128 characters long for each line. There are 5 lines available for additional information.

Click the **Set to Default** button to replace the information with the default information.

Click the **Apply** button to accept the changes made.

Japanese Web-based Access Control

JWAC Global Settings

This window is used to view and configure the Japanese Web-based Access Control (JWAC) global settings.

To view the following window, click **Security > Japanese Web-based Access Control > JWAC Global Settings**, as shown below:

Figure 9-68 JWAC Global Settings window

The fields that can be configured for **JWAC Global Settings** are described below:

Parameter	Description
JWAC State	Select to enable or disable the JWAC feature's global state here.

Click the **Apply** button to accept the changes made.

The fields that can be configured for **JWAC Settings** are described below:

Parameter	Description
UDP Filtering	Select to enable or disable UDP filtering here.
Authentication Method	Select the authentication method used here. Options to choose from are MD5 , CHAP , PAP , MS-CHAP , and MS-CHAP-v2 .
Virtual IP	Select the virtual IP option used here. Options to choose from are IPv4 , IPv6 , and URL .
IPv4 Address	After selecting IPv4 as the Virtual IP , the following field will be available. Enter the virtual IPv4 address used here. All JWAC authentication processes communicate with this IP address, however, the virtual IP does not respond to any ICMP packets or ARP requests. So it's not allowed to configure virtual IP in the same subnet as the switch's IP interface or the same subnet as the host PCs' subnet, otherwise JWAC authentication cannot operate correctly. The defined URL only takes effect when the virtual IP address is configured. The users get the FQDN URL stored on the DNS server to get the virtual IP address. The obtained IP address must match the virtual IP address configured by the command. If the IPv4 virtual IP is not configured, the IPv4 access cannot start JWAC authentication.
IPv6 Address	After selecting IPv6 as the Virtual IP , the following field will be available. Enter the virtual IPv6 address used here. If the IPv6 virtual IP is not configured, the IPv6 access cannot start a JWAC authentication.

Virtual URL	After selecting URL as the Virtual IP , the following field will be available. Enter the virtual URL used here.
Forcible Logout	Select to enable or disable the forcible logout option here. When the forcible logout feature is enabled, a ping packet from an authenticated host to the JWAC switch with a TTL of 1 will be regarded as a logout request and the host will be moved back to unauthenticated state.
Redirect State	Select to enable or disable the redirection state here. When redirect is enabled, all Web access is redirected to the quarantine server or JWAC login page.
Redirect Destination	Select the redirect destination here. Options to choose from are Quarantine Server and JWAC Login Page . When redirecting to the quarantine server, the unauthenticated host will be redirected to the quarantine server when it tries to access a random URL. When redirecting to the JWAC login page, the unauthenticated host will be redirected to the JWAC login page in the switch to finish authentication. When redirecting to the quarantine server is specified, a quarantine server must be configured first before enabling the JWAC function globally. When redirect is disabled, all Web access is denied except for access to the quarantine server or JWAC login page.
Redirect Delay Time	Enter the redirect delay time value here. This value must be between 0 and 10 seconds. By default, this value 1 second.

Click the **Apply** button to accept the changes made.

The fields that can be configured for **Quarantine Server Settings** are described below:

Parameter	Description
Timeout	Enter the quarantine server's timeout value here. This value must be between 5 and 300 seconds. By default, this value is 30 seconds.
Monitor	Select to enable or disable the monitor option here. When the JWAC quarantine server monitor feature is enabled, the JWAC switch will monitor the quarantine server to ensure the server is okay. If the switch detects no quarantine server, it will redirect all unauthenticated HTTP accesses to the JWAC Login Page if the redirect option is enabled and the redirect destination is configured to be quarantine server.
URL	Select the whether the quarantine server uses an IPv4 or IPv6 address and enter the respective IP address in the space provided.

Click the **Apply** button to accept the changes made.

The fields that can be configured for **Update Server Settings** are described below:

Parameter	Description
IPv4 Network Prefix/Prefix Length	Enter the update server's IPv4 address and prefix length here. Any servers (like update.microsoft.com or some sites of Antivirus software companies, which ActiveX needs to access to accomplish the authentication before the client passes the authentication) should be added with its IP address or with the network address. By adding the network address, an entry can serve multiple update servers on the same network. Multiple update server addresses or network addresses can be configured.
IPv6 Network Prefix/Prefix Length	Enter the update server's IPv6 address and prefix length here.

Port	Enter the update server's port used here. This value must be between 1 and 65535. Also select whether this port is a TCP or UDP port.
-------------	---

Click the **Apply** button to accept the changes made.

Click the **Add** button to add a new entry based on the information entered.

Click the **Delete** button to remove the specified entry.

JWAC Port Settings

This window is used to view and configure the JWAC port settings.

To view the following window, click **Security > Japanese Web-based Access Control > JWAC Port Settings**, as shown below:

Unit	From Port	To Port	State	Max Authenticating User (1-100)
1	eth1/0/1	eth1/0/1	Disabled	100

Port	State	Max Authenticating User
eth1/0/1	Disabled	100
eth1/0/2	Disabled	100
eth1/0/3	Disabled	100
eth1/0/4	Disabled	100
eth1/0/5	Disabled	100
eth1/0/6	Disabled	100
eth1/0/7	Disabled	100
eth1/0/8	Disabled	100
eth1/0/9	Disabled	100
eth1/0/10	Disabled	100
eth1/0/11	Disabled	100
eth1/0/12	Disabled	100
eth1/0/13	Disabled	100
eth1/0/14	Disabled	100
eth1/0/15	Disabled	100
eth1/0/16	Disabled	100
eth1/0/17	Disabled	100
eth1/0/18	Disabled	100
eth1/0/19	Disabled	100
eth1/0/20	Disabled	100
eth1/0/21	Disabled	100
eth1/0/22	Disabled	100
eth1/0/23	Disabled	100
eth1/0/24	Disabled	100
eth1/0/25	Disabled	100
eth1/0/26	Disabled	100

Figure 9-69 JWAC Port Settings window

The fields that can be configured are described below:

Parameter	Description
Unit	Select the switch unit that will be used for this configuration here.
From Port / To Port	Select the appropriate port range used for the configuration here.
State	Select whether JWAC is enabled or disabled on the port(s) specified.
Max Authenticating User	Enter the maximum number of authentication users allowed here. This value must be between 1 and 100.

Click the **Apply** button to accept the changes made.

JWAC Customize Page Language

This window is used to view and configure the JWAC customize page's language.

To view the following window, click **Security > Japanese Web-based Access Control > JWAC Customize Page Language**, as shown below:

Figure 9-70 JWAC Customize Page Language window

The fields that can be configured are described below:

Parameter	Description
Customize Page Language	Select the language option that will be used when the JWAC login page is displayed.

Click the **Apply** button to accept the changes made.

JWAC Customize Page

This window is used to view and configure the JWAC customize page settings.

To view the following window, click **Security > Japanese Web-based Access Control > JWAC Customize Page**, as shown below:

Figure 9-71 JWAC Customize Page (English) window

The fields that can be configured are described below:

Parameter	Description
Page Title	Enter a custom page title message here. This message can be up to 128 characters long.
Login window Title	Enter a custom login window title here. This title can be up to 64 characters long.
User Name Title	Enter a custom username title here. This title can be up to 32 characters long.
Password Title	Enter a custom password title here. This title can be up to 32 characters long.
Logout window Title	Enter a custom logout window title here. This title can be up to 64 characters long.
Notification	Enter additional information to display in the notification area here. This information can be up to 128 characters long for each line. There are 5 lines available for additional information.

Click the **Set to Default** button to replace the information with the default information.

Click the **Apply** button to accept the changes made.

After changing the language to **Japanese** the JWAC customize page will look like this.

Figure 9-72 JWAC Customize Page (Japanese) window

Click the **Set to Default** button to replace the information with the default information.

Click the **Apply** button to accept the changes made.

Network Access Authentication

Guest VLAN

This window is used to view and configure the network access authentication guest VLAN settings.

To view the following window, click **Security > Network Access Authentication > Guest VLAN**, as shown below:

Guest VLAN

Guest VLAN

Unit: 1 From Port: eth1/0/1 To Port: eth1/0/1 VID (1-4094):

Total Entries: 1

Port	VID
eth1/0/10	1

Buttons: Apply, Delete, 1/1, <, >, Go

Figure 9-73 Guest VLAN window

The fields that can be configured are described below:

Parameter	Description
Unit	Select the switch unit that will be used for this configuration here.
From Port / To Port	Select the appropriate port range used for the configuration here.
VID	Enter the VLAN ID used here. This value must be between 1 and 4094.

Click the **Apply** button to accept the changes made.

Click the **Delete** button to remove the specified entry.

Network Access Authentication Global Settings

This window is used to view and configure the network access authentication global settings.

To view the following window, click **Security > Network Access Authentication > Network Access Authentication Global Settings**, as shown below:

). A table at the bottom shows one entry: User Name 'User', Password 'password', Password Type 'Plaintext', VID '1'."/>

Network Access Authentication Global Settings

Network Access Authentication MAC Format Settings

Case: Uppercase Delimiter: Dot Delimiter Number: 2

General Settings

Max Users (1-1000): 1000 Deny MAC-Move: Disabled Authorization State: Enabled

User Information

User Name: 32 chars Password Type: Plain Text VID (1-4094): Password:

Total Entries: 1

User Name	Password	Password Type	VID
User	password	Plaintext	1

Buttons: Apply, Delete

Figure 9-74 Network Access Authentication Global Settings window

The fields that can be configured for **Network Access Authentication MAC Format Settings** are described below:

Parameter	Description
Case	Select the case format that will be used for the network access authentication MAC address here. Options to choose from are Lowercase and Uppercase .
Delimiter	Select the delimiter that will be used for the network access authentication MAC address here. Options to choose from are Hyphen , Colon , Dot , and None .
Delimiter Number	Select the delimiter number option here. Options to choose from are 1 , 2 , and 5 .

Click the **Apply** button to accept the changes made.

The fields that can be configured for **General Settings** are described below:

Parameter	Description
Max Users	Enter the maximum amount of users allowed here. This value must be between 1 and 1000. By default, this option is 1000.
Deny MAC-Move	<p>Select to enable or disable the deny MAC-move feature here. This option controls whether to allow authenticated hosts to do roaming across different switch ports and only controls whether a host which is authenticated at a port set to the multi-authenticate mode is allowed to move to another port.</p> <p>If a station is allowed to move, there are two situations. It may either need to be re-authenticated or directly moved to the new port without re-authentication based on the following rule. If the new port has the same authentication configuration as the original port, then re-authentication is not needed. The host will inherit the same authorization attributes with new port. The authenticated host can do roaming from port 1 to port 2, and inherit the authorization attributes without re-authentication. If the new port has the different authentication configuration as the original port, then re-authentication is needed. The authenticated host on port 1 can move and re-authenticated by port 2. If the new port has no authentication method enabled, then the station is directly moved to the new port. The session with the original port is removed. The authenticated host on port 1 can be moved to port 2.</p> <p>If this feature is disabled and an authenticated host moves to another port, then this is treated as a violation error.</p>
Authorization State	Select to enable or disable the authorized state here. The option is used to enable or disable the acceptance of an authorized configuration. When authorization is enabled for authentication, the authorized attributes (for example VLAN, 802.1p default priority, bandwidth, and ACL) assigned by the RADIUS server will be accepted if the authorization status is enabled. Bandwidth and ACL are assigned on a per-port basis. If in the multi-authenticated mode, VLAN and 802.1p are assigned on a per-host basis. Otherwise, Bandwidth and ACL are assigned on a per-port basis.

Click the **Apply** button to accept the changes made.

The fields that can be configured for **User Information** are described below:

Parameter	Description
-----------	-------------

User Name	Enter the user name used here. This name can be up to 32 characters long.
VID	Enter the VLAN ID used here.
Password Type	Select the password type option here. Options to choose from are Plain Text and Encrypted .
Password	Enter the password used here.

Click the **Apply** button to accept the changes made.

Click the **Delete** button to remove the specified entry.

Network Access Authentication Port Settings

This window is used to view and configure the network access authentication port settings.

To view the following window, click **Security > Network Access Authentication > Network Access Authentication Port Settings**, as shown below:

Port	Host Mode	VID List	CompAuth Mode	Max Users	Periodic	ReAuth	Inactivity Timer	Restart
eth1/0/1	Multi Auth		Any	1000	Disabled	3600	Disabled	60
eth1/0/2	Multi Auth		Any	1000	Disabled	3600	Disabled	60
eth1/0/3	Multi Auth		Any	1000	Disabled	3600	Disabled	60
eth1/0/4	Multi Auth		Any	1000	Disabled	3600	Disabled	60
eth1/0/5	Multi Auth		Any	1000	Disabled	3600	Disabled	60
eth1/0/6	Multi Auth		Any	1000	Disabled	3600	Disabled	60
eth1/0/7	Multi Auth		Any	1000	Disabled	3600	Disabled	60
eth1/0/8	Multi Auth		Any	1000	Disabled	3600	Disabled	60
eth1/0/9	Multi Auth		Any	1000	Disabled	3600	Disabled	60
eth1/0/10	Multi Auth		Any	1000	Disabled	3600	Disabled	60
eth1/0/11	Multi Auth		Any	1000	Disabled	3600	Disabled	60
eth1/0/12	Multi Auth		Any	1000	Disabled	3600	Disabled	60
eth1/0/13	Multi Auth		Any	1000	Disabled	3600	Disabled	60
eth1/0/14	Multi Auth		Any	1000	Disabled	3600	Disabled	60
eth1/0/15	Multi Auth		Any	1000	Disabled	3600	Disabled	60
eth1/0/16	Multi Auth		Any	1000	Disabled	3600	Disabled	60
eth1/0/17	Multi Auth		Any	1000	Disabled	3600	Disabled	60
eth1/0/18	Multi Auth		Any	1000	Disabled	3600	Disabled	60
eth1/0/19	Multi Auth		Any	1000	Disabled	3600	Disabled	60
eth1/0/20	Multi Auth		Any	1000	Disabled	3600	Disabled	60
eth1/0/21	Multi Auth		Any	1000	Disabled	3600	Disabled	60

Figure 9-75 Network Access Authentication Port Settings window

The fields that can be configured are described below:

Parameter	Description
Unit	Select the switch unit that will be used for this configuration here.
From Port / To Port	Select the appropriate port range used for the configuration here.

Host Mode	Select the host mode option that will be associated with the selected port(s) here. Options to choose from are Multi Host and Multi Auth . If the port is operated in the multi-host mode, and if one of the hosts is authenticated, then all other hosts are allowed to access the port. According to 802.1X authentication, if the re-authentication fails or the authenticated user logs off, the port will be blocked for a quiet period. The port restores the processing of EAPOL packets after the quiet period. If the port is operated in the multi-authenticated mode, then each host needs to be authenticated individually to access the port. A host is represented by its MAC address. Only the authorized host is allowed to access.
VID List	After selecting the Multi Auth option as the Host Mode , the following parameter is available. Enter the VLAN ID used here. This is useful when different VLANs on the Switch have different authentication requirements. After the client is authenticated, the client will not be re-authenticated when received from other VLANs. This option is useful for trunk ports to do per-VLAN authentication control. When a port's authentication mode is changed to multi-host, the previous authentication VLAN(s) on this port will be cleared.
CompAuth Mode	Select the compound authentication mode option here. Options to choose from are Any , MAC-JWAC , and MAC-WAC . Selecting Any specifies that if any of the authentication method (802.1X, MAC-based Access Control, WAC, or JWAC) to passes, then pass. Selecting MAC-JWAC specifies to verify MAC-based authentication first. If the client passes, JWAC will be verified next. Both authentication methods need to be passed. Selecting MAC-WAC specifies to verify MAC-based authentication first. If the client passes, WAC will be verified next. Both authentication methods need to be passed.
Max Users	Enter the maximum users value used here. This value must be between 1 and 1000.
Periodic	Select to enable or disable periodic re-authentication for the selected port here. This parameter only affects the 802.1X protocol.
ReAuth Timer	Enter the re-authentication timer value here. This value must be between 1 and 65535 seconds. By default, this value is 3600 seconds.
Inactivity State	Select to enable or disable the inactivity state here. Select the Time option to enable this feature.
Inactivity Timer	When the Inactivity State is enabled, enter the inactivity timer value here. This value must be between 120 and 65535 seconds. This parameter only affects the WAC and JWAC authentication protocols.
Restart	Enter the restart time value used here. This value must be between 1 and 65535 seconds.

Click the **Apply** button to accept the changes made.

Network Access Authentication Sessions Information

This window is used to view and clear the network access authentication session information.

To view the following window, click **Security > Network Access Authentication > Network Access Authentication Sessions Information**, as shown below:

Figure 9-76 Network Access Authentication Sessions Information window

The fields that can be configured are described below:

Parameter	Description
Port	Select the appropriate switch unit and port used for the query here.
MAC Address	Enter the MAC address used here.
Protocol	Select the protocol option used here. Options to choose from are MAC , WAC , JWAC , and DOT1X .

Click the **Apply** button to accept the changes made.

Click the **Clear by Port** button to clear the information based on the port selected.

Click the **Clear by MAC** button to clear the information based on the MAC address entered.

Click the **Clear by Protocol** button to clear the information based on the protocol selected.

Click the **Clear All** button to clear all the information in this table.

Click the **Find** button to locate a specific entry based on the information entered.

Click the **View All** button to locate and display all the entries.

Safeguard Engine

Periodically, malicious hosts on the network will attack the Switch by utilizing packet flooding (ARP Storm) or other methods. These attacks may increase the switch's CPU load beyond its capability. To alleviate this problem, the Safeguard Engine function was added to the Switch's software.

The Safeguard Engine can help the overall operability of the Switch by minimizing the workload of the Switch while the attack is ongoing, thus making it capable to forward essential packets over its network in a limited bandwidth.

If the CPU load rises above the rising threshold value, the Safeguard Engine function will be activated and the Switch will enter the exhausted mode. In the exhausted mode, the Switch will limit the bandwidth available for ARP and broadcast IP packets. If the CPU load falls below the falling threshold value, the Safeguard Engine will be deactivated and the Switch will exit the exhausted mode and enter the normal mode.

Packets that are destined to the CPU can be classified into three groups. These groups, otherwise known as sub-interfaces, are logical interfaces that the CPU will use to identify certain types of traffic. The three groups are **Protocol**, **Manage**, and **Route**. Generally, the **Protocol** group should receive the highest priority when the Switch's CPU processes received packets and the **Route** group should receive the lowest priority as the Switch's CPU usually does get involved in the processing of routing packets. In the **Protocol** group, packets are protocol control packets identified by the router. In the **Manage** group,

packets are destined to any router or system network management interface by means of interactive access protocols, like Telnet and SSH. In the **Route** group, packets are identified as traversing routing packets that is generally processed by the router CPU.

In the following table a list of supported protocols are displayed with their respective sub-interfaces (groups):

Protocol Name	Sub-interface (Group)	Description
802.1X	Protocol	Port-based Network Access Control
ARP	Protocol	Address resolution Protocol (ARP)
DHCP	Protocol	Dynamic Host Configuration Protocol
DNS	Protocol	Domain Name System
GVRP	Protocol	GARP VLAN Registration Protocol
ICMPv4	Protocol	Internet Control Message Protocol
ICMPv6-Neighbor	Protocol	IPv6 Internet Control Message Protocol Neighbor Discovery Protocol (NS/NA/RS/RA)
ICMPv6-Other	Protocol	IPv6 Internet Control Message Protocol except Neighbor Discovery Protocol (NS/NA/RS/RA)
IGMP	Protocol	Internet Group Management Protocol
LACP	Protocol	Link Aggregation Control Protocol
SNMP	Manage	Simple Network Management Protocol
SSH	Manage	Secure Shell
STP	Protocol	Spanning Tree Protocol
Telnet	Manage	Telnet
TFTP	Manage	Trivial File Transfer Protocol
Web	Manage	Hypertext Transfer Protocol (HTTP) and Hypertext Transfer Protocol Secure (HTTPS)

A customized rate limit (in packets per second) can be assigned to the Safeguard Engine's sub-interfaces as a whole or to individual protocols specified by the user in the management interface. Be careful when customizing the rate limit for individual protocols, using this function, as improper rate limits can cause the Switch to process packets abnormally.



NOTE: When Safeguard Engine is enabled, the Switch will allot bandwidth to various traffic flows (ARP, IP) using the FFP (Fast Filter Processor) metering table to control the CPU utilization and limit traffic. This may limit the speed of routing traffic over the network.

Safeguard Engine Settings

This window is used to view and configure the safeguard engine settings.

To view the following window, click **Security > Safeguard Engine > Safeguard Engine Settings**, as shown below:

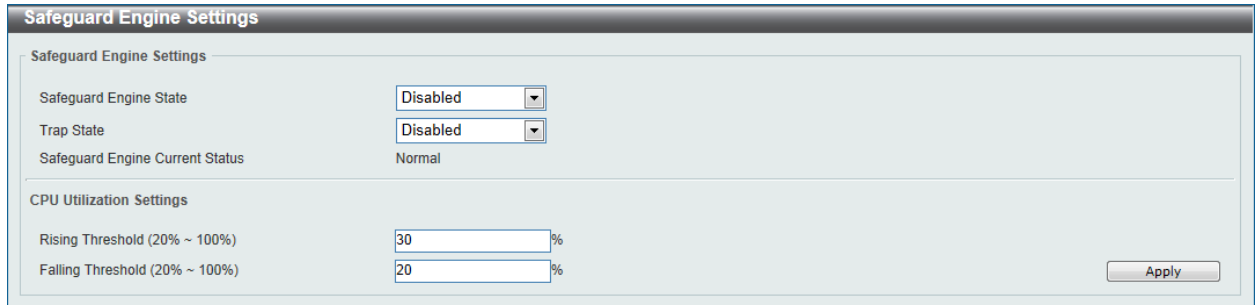

Figure 9-77 Safeguard Engine Settings window

The fields that can be configured for **Safeguard Engine Settings** are described below:

Parameter	Description
Safeguard Engine State	Select to enable or disable the safeguard engine feature here.
Trap State	Select to enable or disable the safeguard engine trap state here.

The fields that can be configured for **CPU Utilization Settings** are described below:

Parameter	Description
Rising Threshold	Enter the rising threshold value here. This value must be between 20% and 100%. This value is used to configure the acceptable level of CPU utilization before the Safeguard Engine mechanism is enabled. Once the CPU utilization reaches this percentage level, the Switch will move into Exhausted mode, based on the parameters provided in this window.
Falling Threshold	Enter the falling threshold value here. This value must be between 20% and 100%. This value is used to configure the acceptable level of CPU utilization as a percentage, where the Switch leaves the Safeguard Engine state and returns to normal mode.

Click the **Apply** button to accept the changes made.

CPU Protect Counters

This window is used to view and clear the CPU protection counter information.

To view the following window, click **Security > Safeguard Engine > CPU Protect Counters**, as shown below:

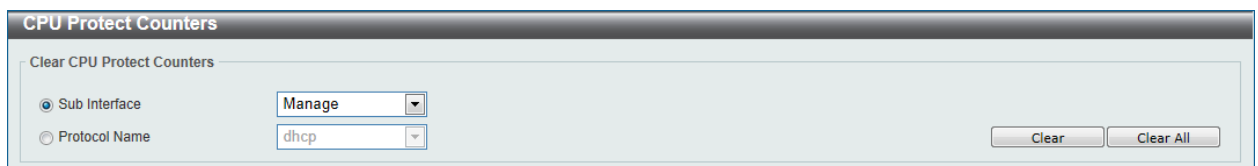

Figure 9-78 CPU Protect Counters window

The fields that can be configured are described below:

Parameter	Description
Sub Interface	Select the sub-interface option here. Options to choose from are Manage , Protocol , Route , and All . This option specifies to clear the

	CPU protect related counters of sub-interfaces.
Protocol Name	Select the protocol name option here. Options to choose from are DHCP, ARP, DNS, GVRP, ICMPv4, ICMPv6-Neighbor, ICMPv6-Other, IGMP, LACP, SNMP, SSH, STP, Telnet, TFTP, Web, 802.1X, and All.

Click the **Clear** button to clear the information based on the selections made.

Click the **Clear All** button to clear all the information in this table.

CPU Protect Sub-Interface

This window is used to view and configure the CPU protection sub-interface settings.

To view the following window, click **Security > Safeguard Engine > CPU Protect Sub-Interface**, as shown below:

Unit	Total	Drop
1	46	0

Figure 9-79 CPU Protect Sub-Interface window

The fields that can be configured for **CPU Protect Sub-Interface** are described below:

Parameter	Description
Sub-Interface	Select the sub-interface option here. Options to choose from are Manage , Protocol , and Route .
Rate Limit	Enter the rate limit value used here. This value must be between 0 and 1024 packets per second. Tick the No Limit option to disable the rate limit.

Click the **Apply** button to accept the changes made.

The fields that can be configured for **Sub-Interface Information** are described below:

Parameter	Description
Sub-Interface	Select the sub-interface option here. Options to choose from are Manage , Protocol , and Route .

Click the **Find** button to locate a specific entry based on the information entered.

CPU Protect Type

This window is used to view and configure the CPU protection type settings.

To view the following window, click **Security > Safeguard Engine > CPU Protect Type**, as shown below:

Figure 9-80 CPU Protect Type window

The fields that can be configured for **CPU Protect Type** are described below:

Parameter	Description
Protocol Name	Select the protocol name option here. Options to choose from are DHCP, ARP, DNS, GVRP, ICMPv4, ICMPv6-Neighbor, ICMPv6-Other, IGMP, LACP, SNMP, SSH, STP, Telnet, TFTP, Web, and 802.1X.
Rate Limit	Enter the rate limit value used here. This value must be between 0 and 1024 packets per second. Tick the No Limit option to disable the rate limit.

Click the **Apply** button to accept the changes made.

The fields that can be configured for **Protect Type Information** are described below:

Parameter	Description
Protocol Name	Select the protocol name option here. Options to choose from are DHCP, ARP, DNS, GVRP, ICMPv4, ICMPv6-Neighbor, ICMPv6-Other, IGMP, LACP, SNMP, SSH, STP, Telnet, TFTP, Web, and 802.1X.

Click the **Find** button to locate a specific entry based on the information entered.

Trusted Host

This window is used to view and configure the trusted host settings.

To view the following window, click **Security > Trusted Host**, as shown below:

Figure 9-81 Trusted Host window

The fields that can be configured are described below:

Parameter	Description
ACL Name	Enter the ACL name used here. This name can be up to 32 characters long.

Type	Select the trusted host type here. Options to choose from are Telnet , SSH , Ping , HTTP , and HTTPS .
-------------	---

Click the **Apply** button to accept the changes made.

Click the **Delete** button to remove the specific entry.

Traffic Segmentation Settings

This window is used to view and configure the traffic segmentation settings. When the traffic segmentation forwarding domain is specified, packets received by the port will be restricted in Layer 2 packet forwarding to interfaces within the domain. When the forwarding domain of a port is empty, Layer 2 forwarding for packets received by the port is not restricted.

The traffic segmentation member list can be comprised of different interface types, for example port and port-channel in the same forwarding domain. If the interfaces specified by the command include a port-channel, all the member ports of this port-channel will be included in the forwarding domain.

If the forwarding domain of an interface is empty, then there is no restriction on Layer 2 forwarding of packets received by the port.

To view the following window, click **Security > Traffic Segmentation Settings**, as shown below:

Figure 9-82 Traffic Segmentation Settings window

The fields that can be configured are described below:

Parameter	Description
Unit	Select the receiving switch unit that will be used for this configuration here.
From Port / To Port	Select the receiving port range used for the configuration here.
Forward Unit	Select the forward switch unit that will be used for this configuration here.
From Forward Port / To Forward Port	Select the forward port range used for the configuration here.

Click the **Add** button to add a new entry based on the information entered.

Click the **Delete** button to remove an entry based on the information entered.

Storm Control

This window is used to view and configure the storm control settings.

To view the following window, click **Security > Storm Control**, as shown below:

Storm Control Settings

Storm Control Trap Settings
 Trap State:

Storm Control Polling Settings
 Interval (5-600): sec Retries (0-360): times Infinite

Storm Control Port Settings
 Unit: From Port: To Port: Type: Action: Level Type: PPS Rise (0-2147483647): pps PPS Low (0-2147483647): pps

Total Entries: 78

Port	Storm	Action	Threshold	Current	State
eth1/0/1	Broadcast	Drop	-	-	Inactive
	Multicast		-	-	Inactive
	Unicast		-	-	Inactive
eth1/0/2	Broadcast	Drop	-	-	Inactive
	Multicast		-	-	Inactive
	Unicast		-	-	Inactive
eth1/0/3	Broadcast	Drop	-	-	Inactive
	Multicast		-	-	Inactive
	Unicast		-	-	Inactive
eth1/0/4	Broadcast	Drop	-	-	Inactive
	Multicast		-	-	Inactive
	Unicast		-	-	Inactive

Figure 9-83 Storm Control window

The fields that can be configured for **Storm Control Trap Settings** are described below:

Parameter	Description
Trap State	Select the storm control trap option here. Options to choose from are None , Storm Occur , Storm Clear , and Both . When None is selected, no traps will be sent. When Storm Occur is selected, a trap notification will be sent when a storm event is detected. When Storm Clear is selected, a trap notification will be sent when a storm event is cleared.

Click the **Apply** button to accept the changes made.

The fields that can be configured for **Storm Control Polling Settings** are described below:

Parameter	Description
Interval	Enter the interval value used here. This value must be between 5 and 600 seconds. By default, this value is 5 seconds.
Retries	Enter the retries value used here. This value must be between 0 and 360. By default, this value is 3. Tick the Infinite option to disable this feature.

Click the **Apply** button to accept the changes made.

The fields that can be configured for **Storm Control Port Settings** are described below:

Parameter	Description
-----------	-------------

Unit	Select the switch unit that will be used for this configuration here.
From Port / To Port	Select the appropriate port range used for the configuration here.
Type	Select the type of storm attack that will be controlled here. Options to choose from are Broadcast , Multicast , and Unicast . When the action is configured as the shutdown mode, the unicast refers to both known and unknown unicast packets; that is, if the known and unknown unicast packets hit the specified threshold, the port will be shutdown. Otherwise, unicast refers to unknown unicast packets.
Action	Select the action that will be taken here. Options to choose from are None , Shutdown , and Drop . Selecting None specifies not to filter the storm packets. Selecting Shutdown specifies to shut down the port when the value specified for rise threshold is reached. Selecting Drop specifies to discards packets that exceed the risen threshold.
Level Type	Select the level type option here. Options to choose from are PPS , Kbps , and Level .
PPS Rise	Enter the rise packets per second value here. This option specifies the rise threshold value in packets count per second. This value must be between 0 and 2147483647 packets per second. If the low PPS value is not specified, the default value is 80% of the specified risen PPS.
PPS Low	Enter the low packets per second value here. This option specifies the low threshold value in packets count per second. This value must be between 0 and 2147483647 packets per second. If the low PPS value is not specified, the default value is 80% of the specified risen PPS.

Click the **Apply** button to accept the changes made.

After selecting the **Kbps** option as the **Level Type**, the following parameters are available.

The screenshot shows the 'Storm Control Port Settings' window. It contains several dropdown menus and input fields. The 'Unit' dropdown is set to '1'. The 'From Port' and 'To Port' dropdowns are both set to 'eth1/0/1'. The 'Type' dropdown is set to 'Broadcast'. The 'Action' dropdown is set to 'None'. The 'Level Type' dropdown is set to 'Kbps'. To the right of the 'Level Type' dropdown are two input fields: 'KBPS Rise (0-2147483647)' and 'KBPS Low (0-2147483647)', both followed by 'Kbps' text. An 'Apply' button is located at the bottom right of the form.

Figure 9-84 Storm Control (Kbps) window

The fields that can be configured are described below:

Parameter	Description
KBPS Rise	Enter the rise KBPS value used here. This option specifies the rise threshold value as a rate of kilobits per second at which traffic is received on the port. This value must be between 0 and 2147483647 Kbps.
KBPS Low	Enter the low KBPS value used here. This option specifies the low threshold value as a rate of kilobits per second at which traffic is received on the port. This value must be between 0 and 2147483647 Kbps. If the low KBPS is not specified, the default value is 80% of the specified risen KBPS.

Click the **Apply** button to accept the changes made.

After selecting the **Level** option as the **Level Type**, the following parameters are available.

Figure 9-85 Storm Control (Level) window

The fields that can be configured are described below:

Parameter	Description
Level Rise	Enter the rise level value used here. This option specifies the rise threshold value as a percentage of the total bandwidth per port at which traffic is received on the port. This value must be between 0% and 100%.
Level Low	Enter the low level value used here. This option specifies the low threshold value as a percentage of the total bandwidth per port at which traffic is received on the port. This value must be between 0% and 100%. If the low level is not specified, the default value is 80% of the specified risen level.

Click the **Apply** button to accept the changes made.

DoS Attack Prevention Settings

This window is used to view and configure the Denial-of-Service (DoS) attack prevention settings. The following well-known DoS types which can be detected by most switches:

- **Land Attack:** This type of attack involves IP packets where the source and destination address are set to the address of the target device. It may cause the target device to reply to itself continuously.
- **Blat Attack:** This type of attack will send packets with the TCP/UDP source port equal to the destination port of the target device. It may cause the target device to respond to itself.
- **TCP-Null:** This type of attack involves port scanning by using specific packets which contain a sequence number of 0 and no flags.
- **TCP-Xmas:** This type of attack involves port scanning by using specific packets which contain a sequence number of 0 and the Urgent (URG), Push (PSH), and FIN flags.
- **TCP SYN-FIN:** This type of attack involves port scanning by using specific packets which contain SYN and FIN flags.
- **TCP SYN SrcPort Less 1024:** This type of attack involves port scanning by using specific packets which contain source port 0 to 1023 and SYN flag.
- **Ping of Death Attack:** A ping of death is a type of attack on a computer that involves sending a malformed or otherwise a malicious ping to a computer. A ping is normally 64 bytes in size (many computers cannot handle a ping larger than the maximum IP packet size) which is 65535 bytes. The sending of a ping of this size can crash the target computer. Traditionally, this bug has been relatively easy to exploit. Generally, sending a 65536 byte ping packet is illegal according to networking protocol, but a packet of such a size can be sent if it is fragmented; when the target computer reassembles the packet, a buffer overflow can occur, which often causes a system crash.
- **TCP Tiny Fragment Attack:** The Tiny TCP Fragment attacker uses IP fragmentation to create extremely small fragments and force the TCP header information into a separate packet fragment to pass through the check function of the router and issue an attack.
- **All Types:** All of above types.

To view the following window, click **Security > DoS Attack Prevention Settings**, as shown below:

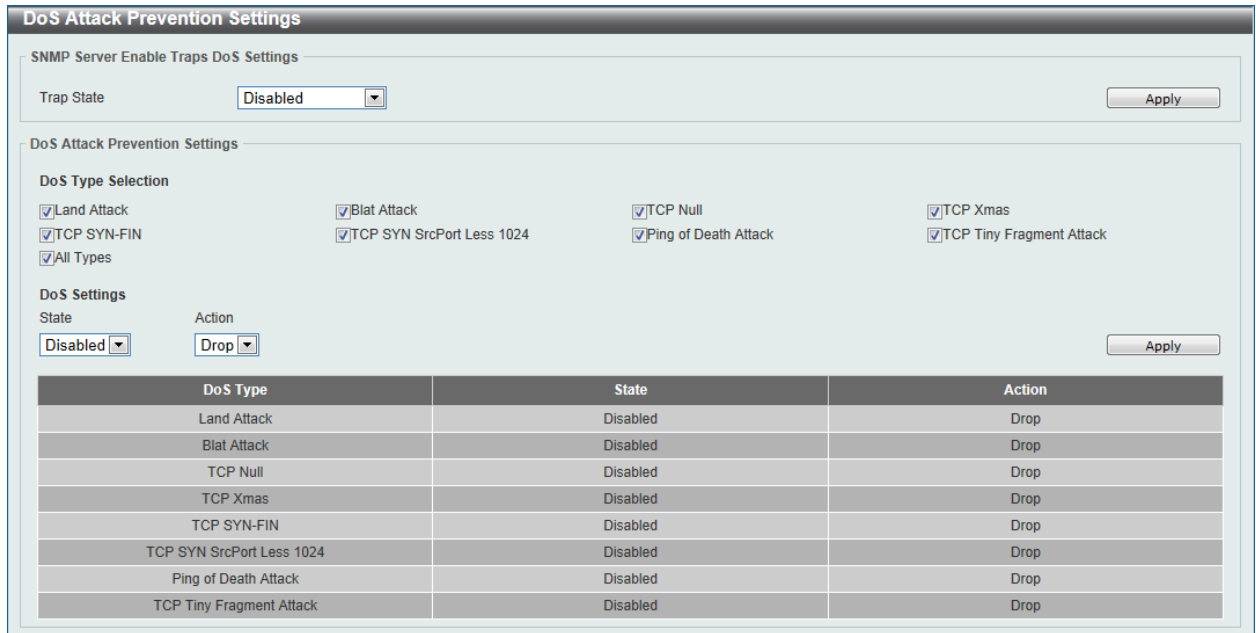

DoS Attack Prevention Settings

SNMP Server Enable Traps DoS Settings

Trap State:

DoS Attack Prevention Settings

DoS Type Selection

Land Attack Blat Attack TCP Null TCP Xmas
 TCP SYN-FIN TCP SYN SrcPort Less 1024 Ping of Death Attack TCP Tiny Fragment Attack
 All Types

DoS Settings

State: Action:

DoS Type	State	Action
Land Attack	Disabled	Drop
Blat Attack	Disabled	Drop
TCP Null	Disabled	Drop
TCP Xmas	Disabled	Drop
TCP SYN-FIN	Disabled	Drop
TCP SYN SrcPort Less 1024	Disabled	Drop
Ping of Death Attack	Disabled	Drop
TCP Tiny Fragment Attack	Disabled	Drop

Figure 9-86 DoS Attack Prevention Settings window

The fields that can be configured for **SNMP Server Enable Traps DoS Settings** are described below:

Parameter	Description
Trap State	Select to enable or disable the DoS attack prevention trap state here.

Click the **Apply** button to accept the changes made.

The fields that can be configured for **DoS Attack Prevention Settings** are described below:

Parameter	Description
DoS Type Selection	Tick the DoS type option that will be prevented here.
State	Select to enable or disable the DoS attack prevention feature's global state here.
Action	Select the action that will be taken when the DoS attack was detected here. The only option to select here is Drop .

Click the **Apply** button to accept the changes made.

SSH

Secure Shell (SSH) is a program allowing secure remote login and secure network services over an insecure network. It allows a secure login to remote host computers, a safe method of executing commands on a remote end node, and will provide secure encrypted and authenticated communication between two non-trusted hosts. SSH, with its array of unmatched security features is an essential tool in today's networking environment. It is a powerful guardian against numerous existing security hazards that now threaten network communications.

The steps required to use the SSH protocol for secure communication between a remote PC (the SSH client) and the Switch (the SSH server) are as follows:

- Create a user account with admin-level access using the User Accounts window. This is identical to creating any other admin-level User Account on the Switch, including specifying a password. This password is used to logon to the Switch, once a secure communication path has been established using the SSH protocol.
- Configure the User Account to use a specified authorization method to identify users that are allowed to establish SSH connections with the Switch using the SSH User Authentication Mode window. There are three choices as to the method SSH will use to authorize the user, which are Host Based, Password, and Public Key.
- Configure the encryption algorithm that SSH will use to encrypt and decrypt messages sent between the SSH client and the SSH server, using the SSH Authentication Method and Algorithm Settings window.
- Finally, enable SSH on the Switch using the SSH Configuration window.

After completing the preceding steps, a SSH Client on a remote PC can be configured to manage the Switch using a secure, in band connection.

SSH Global Settings

This window is used to view and configure the SSH global settings.

To view the following window, click **Security > SSH > SSH Global Settings**, as shown below:

Figure 9-87 SSH Global Settings window

The fields that can be configured are described below:

Parameter	Description
IP SSH Server State	Select to enable or disable the SSH server's global state.
IP SSH Service Port	Enter the SSH service port number used here. This value must be between 1 and 65535. By default, this number is 22.
Authentication Timeout	Enter the authentication timeout value here. This value must be between 30 and 600 seconds. By default, this value is 120 seconds.
Authentication Retries	Enter the authentication retries value here. This value must be between 1 and 32. By default, this value is 3.

Click the **Apply** button to accept the changes made.

Host Key

This window is used to view and generate the SSH host key.

To view the following window, click **Security > SSH > Host Key**, as shown below:

Figure 9-88 Host Key window

The fields that can be configured for **Host Key Management** are described below:

Parameter	Description
Crypto Key Type	Select the crypto key type used here. Options to choose from are the Rivest Shamir Adleman (RSA) key type and the Digital Signature Algorithm (DSA) key type.
Key Modulus	Select the key modulus value here. Options to choose from are 360 , 512 , 768 , 1024 , and 2048 bit.

Click the **Generate** button to generate a host key based on the selections made.

Click the **Delete** button to remove a host key based on the selections made.

The fields that can be configured for **Host Key** are described below:

Parameter	Description
Crypto Key Type	Select the crypto key type used here. Options to choose from are the Rivest Shamir Adleman (RSA) key type and the Digital Signature Algorithm (DSA) key type.

SSH Server Connection

This window is used to view the SSH server connections table.

To view the following window, click **Security > SSH > SSH Server Connection**, as shown below:

Figure 9-89 SSH Server Connection window

SSH User Settings

This window is used to view and configure the SSH user settings.

To view the following window, click **Security > SSH > SSH User Settings**, as shown below:

Figure 9-90 SSH User Settings window

The fields that can be configured are described below:

Parameter	Description
User Name	Enter the SSH user's username used here. This name can be up to 32 characters long.
Authentication Method	Select the authentication methods used here. Options to choose from are Password , Public Key , and Host-based .
Key File	After selecting the Public Key or Host-based option as the Authentication Method , enter the public key here.
Host Name	After selecting the Host-based option as the Authentication Method , enter the host name here.
IPv4 Address	After selecting the Host-based option as the Authentication Method , select and enter the IPv4 address here.
IPv6 Address	After selecting the Host-based option as the Authentication Method , select and enter the IPv6 address here.

Click the **Apply** button to accept the changes made.

Enter a page number and click the **Go** button to navigate to a specific page when multiple pages exist.

SSL

Secure Sockets Layer (SSL) is a security feature that will provide a secure communication path between a host and client through the use of authentication, digital signatures and encryption. These security functions are implemented through the use of a cipher suite, which is a security string that determines the exact cryptographic parameters, specific encryption algorithms and key sizes to be used for an authentication session and consists of three levels:

- **Key Exchange:** The first part of the Cipher suite string specifies the public key algorithm to be used. This switch utilizes the Rivest Shamir Adleman (RSA) public key algorithm and the Digital Signature Algorithm (DSA), specified here as the DHE DSS Diffie-Hellman (DHE) public key algorithm. This is the first authentication process between client and host as they "exchange keys" in looking for a match and therefore authentication to be accepted to negotiate encryptions on the following level.
- **Encryption:** The second part of the cipher suite that includes the encryption used for encrypting the messages sent between client and host. The Switch supports two types of cryptology algorithms:
 - **Stream Ciphers** – There are two types of stream ciphers on the Switch, RC4 with 40-bit keys and RC4 with 128-bit keys. These keys are used to encrypt messages and need to be consistent between client and host for optimal use.
 - **CBC Block Ciphers** – CBC refers to Cipher Block Chaining, which means that a portion of the previously encrypted block of encrypted text is used in the encryption of the current

block. The Switch supports the 3DES EDE encryption code defined by the Data Encryption Standard (DES) to create the encrypted text.

- **Hash Algorithm:** This part of the cipher suite allows the user to choose a message digest function which will determine a Message Authentication Code. This Message Authentication Code will be encrypted with a sent message to provide integrity and prevent against replay attacks. The Switch supports two hash algorithms, MD5 (Message Digest 5) and SHA (Secure Hash Algorithm).

These three parameters are uniquely assembled in four choices on the Switch to create a three-layered encryption code for secure communication between the server and the host. The user may implement any one or combination of the cipher suites available, yet different cipher suites will affect the security level and the performance of the secured connection. The information included in the cipher suites is not included with the Switch and requires downloading from a third source in a file form called a certificate. This function of the Switch cannot be executed without the presence and implementation of the certificate file and can be downloaded to the Switch by utilizing a TFTP server. The Switch supports SSLv3. Other versions of SSL may not be compatible with this Switch and may cause problems upon authentication and transfer of messages from client to host.

When the SSL function has been enabled, the web will become disabled. To manage the Switch through the web based management while utilizing the SSL function, the web browser must support SSL encryption and the header of the URL must begin with https://. (Ex. https://xx.xx.xx.xx) Any other method will result in an error and no access can be authorized for the web-based management.

Users can download a certificate file for the SSL function on the Switch from a TFTP server. The certificate file is a data record used for authenticating devices on the network. It contains information on the owner, keys for authentication and digital signatures. Both the server and the client must have consistent certificate files for optimal use of the SSL function. The Switch only supports certificate files with .der file extensions. Currently, the Switch comes with a certificate pre-loaded though the user may need to download more, depending on user circumstances.

SSL Global Settings

This window is used to view and configure the SSL feature's global settings.

To view the following window, click **Security > SSL > SSL Global Settings**, as shown below:

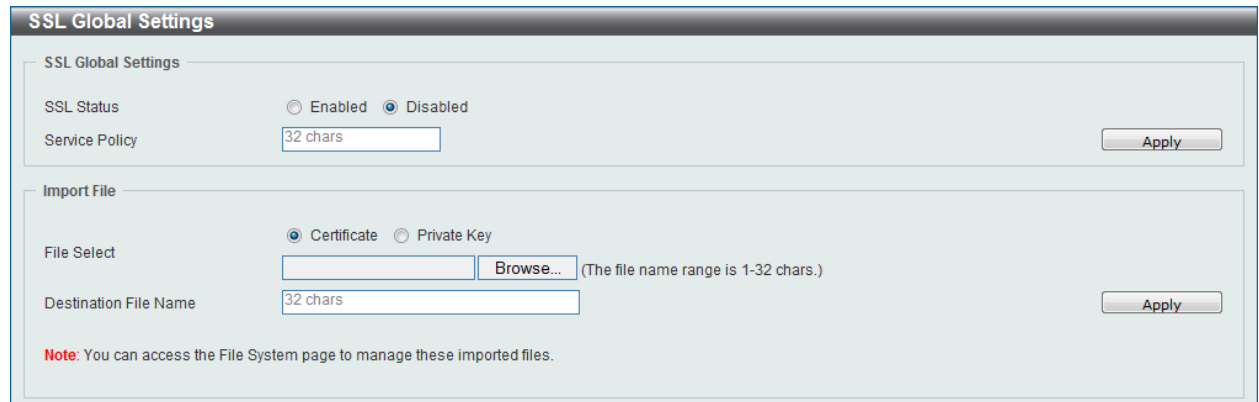

Figure 9-91 SSL Global Settings window

The fields that can be configured for **SSL Global Settings** are described below:

Parameter	Description
SSL Status	Select to enable or disable the SSL feature's global status here.
Service Policy	Enter the service policy name here. This name can be up to 32 characters long.

Click the **Apply** button to accept the changes made.

The fields that can be configured for **Import File** are described below:

Parameter	Description
File Select	Select the file type that will be loaded here. Options to choose from are Certificate and Private Key . After selecting the file type, browse to the appropriate file, located on the local computer, by pressing the Browse button.
Destination File Name	Enter the destination file name used here. This name can be up to 32 characters long.

Click the **Apply** button to accept the changes made.

Crypto PKI Trustpoint

This window is used to view and configure the crypto PKI trust point settings.

To view the following window, click **Security > SSL > Crypto PKI Trustpoint**, as shown below:

The screenshot shows the 'Crypto PKI Trustpoint' configuration window. It features a form with the following fields and controls:

- Trustpoint:** A text input field with a '32 chars' character limit. To its right are 'Apply' and 'Find' buttons.
- Trustpoint:** A second text input field with a '32 chars' character limit.
- File System Path:** A radio button selected next to this label, with a text input field containing 'e.g. ./cacert'.
- TFTP Server Path:** A radio button next to this label, with a text input field containing 'e.g. /ip/name'.
- Password:** A text input field with a '64 chars' character limit.
- Type:** A dropdown menu currently set to 'Local'. To its right is an 'Apply' button.

Below the form, it indicates 'Total Entries: 1' and displays a table with the following structure:

Primary	Trustpoint Name	CA	Local Certificate	Local Private Key	
<input type="checkbox"/>	TrustPoint				<input type="button" value="Delete"/>

Figure 9-92 Crypto PKI Trustpoint window

The fields that can be configured are described below:

Parameter	Description
Trustpoint	Enter the name of the trust-point that is associated with the imported certificates and key pairs here. This name can be up to 32 characters long.
File System Path	Enter the file system path for certificates and key pairs here.
Password	Enter the encrypted password phrase that is used to undo encryption when the private keys are imported here. The password phrase is a string of up to 64 characters. If the password phrase is not specified, the NULL string will be used.
TFTP Server Path	Enter the TFTP server's path here.
Type	Select the type of certificate that will be imported here. Options to choose from are Both , CA , and Local . Selecting Both specifies to import the CA certificate, local certificate and key pairs. Selecting CA specifies to import the CA certificate only. Selecting Local specifies to import local certificate and key pairs only.

Click the **Apply** button to accept the changes made.

Click the **Find** button to locate a specific entry based on the information entered.

Click the **Delete** button to remove the specified entry.

SSL Service Policy

This window is used to view and configure the SSL service policy settings.

To view the following window, click **Security > SSL > SSL Service Policy**, as shown below:

The screenshot shows the 'SSL Service Policy' configuration window. It includes the following fields and options:

- Policy Name:** 32 chars (with an 'Apply' button)
- Session Cache Timeout (60-86400):** 600 sec
- Secure Trustpoint:** 32 chars
- Cipher Suites:**
 - DHE_DSS_WITH_3DES_EDE_CBC_SHA
 - RSA_WITH_3DES_EDE_CBC_SHA
 - RSA_WITH_RC4_128_SHA
 - RSA_EXPORT_WITH_RC4_40_MD5
 - RSA_WITH_RC4_128_MD5

At the bottom, there is a table with the following data:

Policy Name	Cipher Suites	Session Cache Timeout (sec)	Secure Trustpoint
Policy	DHE_DSS_WITH_3DES_ED...	600	

Buttons for 'Apply', 'Find', 'Edit', and 'Delete' are also present.

Figure 9-93 SSL Service Policy window

The fields that can be configured are described below:

Parameter	Description
Policy Name	Enter the SSL service policy name here. This name can be up to 32 characters long.
Session Cache Timeout	Enter the session cache timeout value used here. This value must be between 60 and 86400 seconds. By default, this value is 600 seconds.
Secure Trustpoint	Enter the secure trust point's name here. This name can be up to 32 characters long.
Cipher Suites	Select the cipher suites that will be associated with this profile here.

Click the **Apply** button to accept the changes made.

Click the **Find** button to locate a specific entry based on the information entered.

Click the **Edit** button to re-configure the specific entry.

Click the **Delete** button to remove the specified entry.

10. OAM

Cable Diagnostics DDM

Cable Diagnostics

The cable diagnostics feature is designed primarily for administrators or customer service representatives to verify and test copper cables; it can rapidly determine the quality of the cables and the types of error.

To view the following window, click **OAM > Cable Diagnostics**, as shown below:

Port	Type	Link Status	Test Result	Cable Length (M)	
eth1/0/1	1000BASE-T	Link Up	(OK)	2	Clear
eth1/0/2	1000BASE-T	Link Down	-	-	Clear
eth1/0/3	1000BASE-T	Link Down	-	-	Clear
eth1/0/4	1000BASE-T	Link Down	-	-	Clear
eth1/0/5	1000BASE-T	Link Down	-	-	Clear
eth1/0/6	1000BASE-T	Link Down	-	-	Clear
eth1/0/7	1000BASE-T	Link Down	-	-	Clear
eth1/0/8	1000BASE-T	Link Down	-	-	Clear

Figure 10-1 Cable Diagnostics window

The fields that can be configured are described below:

Parameter	Description
Unit	Select the switch unit that will be used for this configuration here.
From Port / To Port	Select the appropriate port range used for the configuration here.

Click the **Test** button to test the specific port.

Click the **Clear** button to clear all the information for the specific port.

Click the **Clear All** button to clear all the information in this table.

DDM

This folder contains windows that perform Digital Diagnostic Monitoring (DDM) functions on the Switch. There are windows that allow the user to view the digital diagnostic monitoring status of SFP modules inserting to the Switch and to configure alarm settings, warning settings, temperature threshold settings, voltage threshold settings, bias current threshold settings, Tx power threshold settings, and Rx power threshold settings.

DDM Settings

The window is used to configure the action that will occur for specific ports when an exceeding alarm threshold or warning threshold event is encountered.

To view the following window, click **OAM > DDM > DDM Settings**, as show below:

Figure 10-2 DDM Settings window

The fields that can be configured are described below:

Parameter	Description
Transceiver Monitoring Traps Alarm	Select this option to enable or disable sending alarm level trap.
Transceiver Monitoring Traps Warning	Select this option to enable or disable sending warning level trap.
Unit	Select the switch unit that will be used for this configuration here.
From Port / To Port	Select the appropriate port range used for the configuration here.
State	Use the drop-down menu to enable or disable the DDM state.
Shutdown	Specify whether to shut down the port, when the operating parameter exceeds the Alarm or Warning threshold. Alarm - Shutdown the port when the configured alarm threshold range is exceeded. Warning - Shutdown the port when the configured warning threshold range is exceeded. None - The port will never shutdown regardless if the threshold ranges are exceeded or not. This is the default.

Click the **Apply** button to accept the changes made for each individual section.

DDM Temperature Threshold Settings

This window is used to configure the DDM Temperature Threshold Settings for specific ports on the Switch.

To view the following window, click **OAM > DDM > DDM Temperature Threshold Settings**, as show below:

Figure 10-3 DDM Temperature Threshold Settings window

The fields that can be configured are described below:

Parameter	Description
Unit	Select the switch unit that will be used for this configuration here.
Port	Select the port used for the configuration here.
Action	Select the action that will be taken here. Options to choose from are Add and Delete .
Type	Select the type of temperature threshold. Options to choose from are Low Alarm , Low Warning , High Alarm , and High Warning .
Value	Enter the threshold value. This value must be between -128 and 127.996 °C.

Click the **Apply** button to accept the changes made.

DDM Voltage Threshold Settings

This window is used to configure the DDM Voltage Threshold Settings for specific ports on the Switch.

To view the following window, click **OAM > DDM > DDM Voltage Threshold Settings**, as show below:

Figure 10-4 DDM Voltage Threshold Settings window

The fields that can be configured are described below:

Parameter	Description
Unit	Select the switch unit that will be used for this configuration here.

Port	Select the port used for the configuration here.
Action	Select the action that will be taken here. Options to choose from are Add and Delete .
Type	Select the type of voltage threshold. Options to choose from are Low Alarm , Low Warning , High Alarm , and High Warning .
Value	Enter the threshold value. This value must be between 0 and 6.55 Volt.

Click the **Apply** button to accept the changes made.

DDM Bias Current Threshold Settings

This window is used to configure the threshold of the bias current for specific ports on the Switch.

To view the following window, click **OAM > DDM > DDM Bias Current Threshold Settings**, as show below:

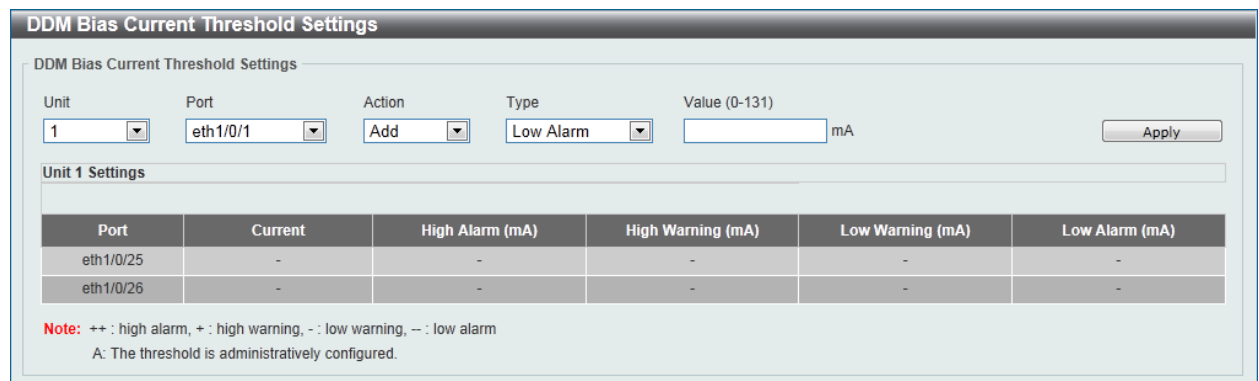

DDM Bias Current Threshold Settings

DDM Bias Current Threshold Settings

Unit: 1 Port: eth1/0/1 Action: Add Type: Low Alarm Value (0-131): mA

Unit 1 Settings

Port	Current	High Alarm (mA)	High Warning (mA)	Low Warning (mA)	Low Alarm (mA)
eth1/0/25	-	-	-	-	-
eth1/0/26	-	-	-	-	-

Note: ++ : high alarm, + : high warning, - : low warning, -- : low alarm
A: The threshold is administratively configured.

Figure 10-5 DDM Bias Current Threshold Settings window

The fields that can be configured are described below:

Parameter	Description
Unit	Select the switch unit that will be used for this configuration here.
Port	Select the port used for the configuration here.
Action	Select the action that will be taken here. Options to choose from are Add and Delete .
Type	Select the type of bias current threshold. Options to choose from are Low Alarm , Low Warning , High Alarm , and High Warning .
Value	Enter the threshold value. This value must be between 0 and 131 mA.

Click the **Apply** button to accept the changes made.

DDM TX Power Threshold Settings

This window is used to configure the threshold of TX power for specific ports on the Switch.

To view the following window, click **OAM > DDM > DDM TX Power Threshold Settings**, as show below:

DDM TX Power Threshold Settings

DDM TX Power Threshold Settings

Unit: 1 Port: eth1/0/1 Action: Add Type: Low Alarm Power Unit: mW Value (0-6.5535): mW

Unit 1 Settings

Port	Current	High Alarm (mW)	High Warning (mW)	Low Warning (mW)	Low Alarm (mW)
eth1/0/25	-	-	-	-	-
eth1/0/26	-	-	-	-	-

Note: ++ : high alarm, + : high warning, - : low warning, -- : low alarm
A: The threshold is administratively configured.

Figure 10-6 DDM TX Power Threshold Settings window

The fields that can be configured are described below:

Parameter	Description
Unit	Select the switch unit that will be used for this configuration here.
Port	Select the port used for the configuration here.
Action	Select the action that will be taken here. Options to choose from are Add and Delete .
Type	Select the type of TX power threshold. Options to choose from are Low Alarm , Low Warning , High Alarm , and High Warning .
Power Unit	Select the power unit here. Options to choose from are mW and dBm .
Value	Enter the threshold value. When selecting mW in the Power Unit drop-down list, this value must be between 0 and 6.5535. When selecting dBm in the Power Unit drop-down list, this value must be between -40 and 8.1647.

Click the **Apply** button to accept the changes made.

DDM RX Power Threshold Settings

This window is used to configure the threshold of RX power for specific ports on the Switch.

To view the following window, click **OAM > DDM > DDM RX Power Threshold Settings**, as show below:

DDM RX Power Threshold Settings

DDM RX Power Threshold Settings

Unit: 1 Port: eth1/0/1 Action: Add Type: Low Alarm Power Unit: mW Value (0-6.5535): mW

Unit 1 Settings

Port	Current	High Alarm (mW)	High Warning (mW)	Low Warning (mW)	Low Alarm (mW)
eth1/0/25	-	-	-	-	-
eth1/0/26	-	-	-	-	-

Note: ++ : high alarm, + : high warning, - : low warning, -- : low alarm
A: The threshold is administratively configured.

Figure 10-7 DDM RX Power Threshold Settings window

The fields that can be configured are described below:

Parameter	Description
Unit	Select the switch unit that will be used for this configuration here.
Port	Select the port used for the configuration here.
Action	Select the action that will be taken here. Options to choose from are Add and Delete .
Type	Select the type of RX power threshold. Options to choose from are Low Alarm , Low Warning , High Alarm , and High Warning .
Power Unit	Select the power unit here. Options to choose from are mW and dBm .
Value	Enter the threshold value. When selecting mW in the Power Unit drop-down list, this value must be between 0 and 6.5535. When selecting dBm in the Power Unit drop-down list, this value must be between -40 and 8.1647.

Click the **Apply** button to accept the changes made.

DDM Status Table

This window is used to display the current operating digital diagnostic monitoring parameters and their values on the SFP module for specified ports.

To view the following window, click **OAM > DDM > DDM Status Table**, as show below:

DDM Status Table					
DDM Status Table					
Total Entries: 0					
Port	Temperature (Celsius)	Voltage (V)	Bias Current (mA)	TX Power (mW)	RX Power (mW)
Note: ++ : high alarm, + : high warning, - : low warning, -- : low alarm					

Figure 10-8 DDM Status Table window

11. Monitoring

Utilization
Statistics
Mirror Settings
Device Environment

Utilization

Port Utilization

This window is used to display the percentage of the total available bandwidth being used on the port.

To view the following window, click **Monitoring > Utilization > Port Utilization**, as show below:

Port	TX (packets/sec)	RX (packets/sec)	Utilization
eth1/0/1	25	17	1
eth1/0/2	0	0	0
eth1/0/3	0	0	0
eth1/0/4	0	0	0
eth1/0/5	0	0	0
eth1/0/6	0	0	0
eth1/0/7	0	0	0
eth1/0/8	0	0	0
eth1/0/9	0	0	0
eth1/0/10	0	0	0
eth1/0/11	0	0	0
eth1/0/12	0	0	0
eth1/0/13	0	0	0
eth1/0/14	0	0	0
eth1/0/15	0	0	0
eth1/0/16	0	0	0
eth1/0/17	0	0	0
eth1/0/18	0	0	0
eth1/0/19	0	0	0
eth1/0/20	0	0	0
eth1/0/21	0	0	0
eth1/0/22	0	0	0
eth1/0/23	0	0	0
eth1/0/24	0	0	0
eth1/0/25	0	0	0
eth1/0/26	0	0	0

Figure 11-1 Port Utilization window

The fields that can be configured are described below:

Parameter	Description
Unit	Select the switch unit that will be used for this configuration here.
From Port / To Port	Select the appropriate port range used for the configuration here.

Click the **Find** button to locate a specific entry based on the information entered.

Click the **Refresh** button to refresh the display table.

Statistics

Port

This window is used to display the packet statistics of ports.

To view the following window, click **Monitoring > Statistics > Port**, as show below:

Port	RX				TX				Show Detail
	Rate		Total		Rate		Total		
	bytes/sec	packets/sec	bytes	packets	bytes/sec	packets/sec	bytes	packets	
eth1/0/1	7273	38	5071264	27919	59725	63	15901578	26588	Show Detail
eth1/0/2	0	0	0	0	0	0	0	0	Show Detail
eth1/0/3	0	0	0	0	0	0	0	0	Show Detail
eth1/0/4	0	0	0	0	0	0	0	0	Show Detail
eth1/0/5	0	0	0	0	0	0	0	0	Show Detail
eth1/0/6	0	0	0	0	0	0	0	0	Show Detail
eth1/0/7	0	0	0	0	0	0	0	0	Show Detail
eth1/0/8	0	0	0	0	0	0	0	0	Show Detail
eth1/0/9	0	0	0	0	0	0	0	0	Show Detail
eth1/0/10	0	0	0	0	0	0	0	0	Show Detail
eth1/0/11	0	0	0	0	0	0	0	0	Show Detail
eth1/0/12	0	0	0	0	0	0	0	0	Show Detail
eth1/0/13	0	0	0	0	0	0	0	0	Show Detail
eth1/0/14	0	0	0	0	0	0	0	0	Show Detail
eth1/0/15	0	0	0	0	0	0	0	0	Show Detail

Figure 11-2 Port window

The fields that can be configured are described below:

Parameter	Description
Unit	Select the switch unit that will be used for this configuration here.
From Port / To Port	Select the appropriate port range used for the configuration here.

Click the **Find** button to locate a specific entry based on the information entered.

Click the **Refresh** button to refresh the display table.

Click the **Show Detail** button to see the detail information of the specific port.

After clicking the **Show Detail** button, the following page will appear.

eth1/0/1	
RX rate	5282 bytes/sec
TX rate	27337 bytes/sec
RX bytes	5097652
TX bytes	15964669
RX rate	20 packets/sec
TX rate	29 packets/sec
RX packets	28066
TX packets	26702
RX multicast	583
RX broadcast	220
RX CRC error	0
RX undersize	0
RX oversize	0
RX fragment	0
RX jabber	0
RX dropped Pkts	799
RX MTU exceeded	0
TX CRC error	0
TX excessive deferral	0
TX single collision	0
TX excessive collision	0
TX late collision	0
TX collision	0

Figure 11-3 Port Detail window

Click the **Back** button to return to the previous window.

Click the **Refresh** button to refresh the display table.

Port Counters

This window is used to display port counter statistics.

To view the following window, click **Monitoring > Statistics > Port Counters**, as show below:

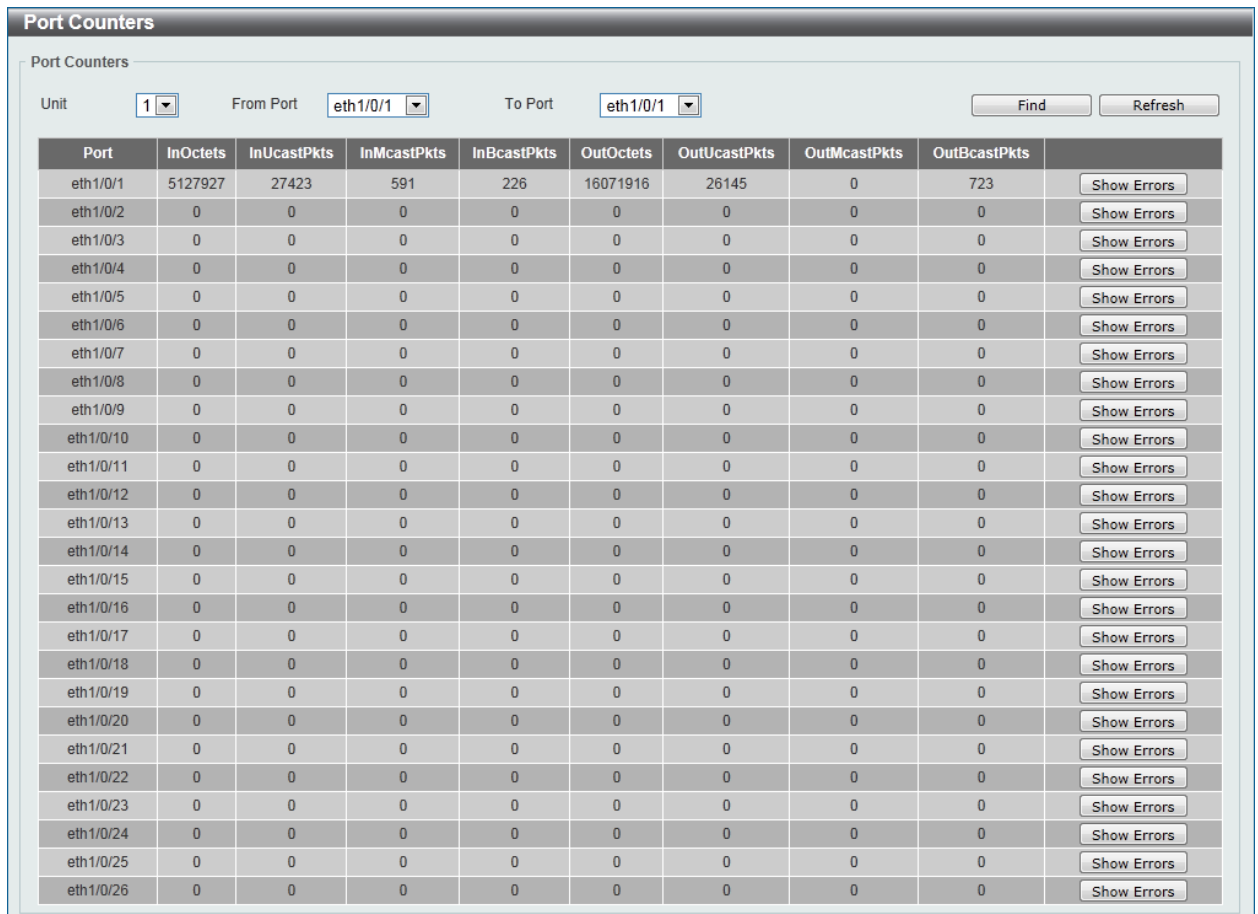

Figure 11-4 Port Counters window

The fields that can be configured are described below:

Parameter	Description
Unit	Select the switch unit that will be used for this configuration here.
From Port / To Port	Select the appropriate port range used for the configuration here.

Click the **Find** button to locate a specific entry based on the information entered.

Click the **Refresh** button to refresh the display table.

Click the **Show Errors** button to see all error counters of the specific port.

After clicking the **Show Errors** button, the following page will appear.

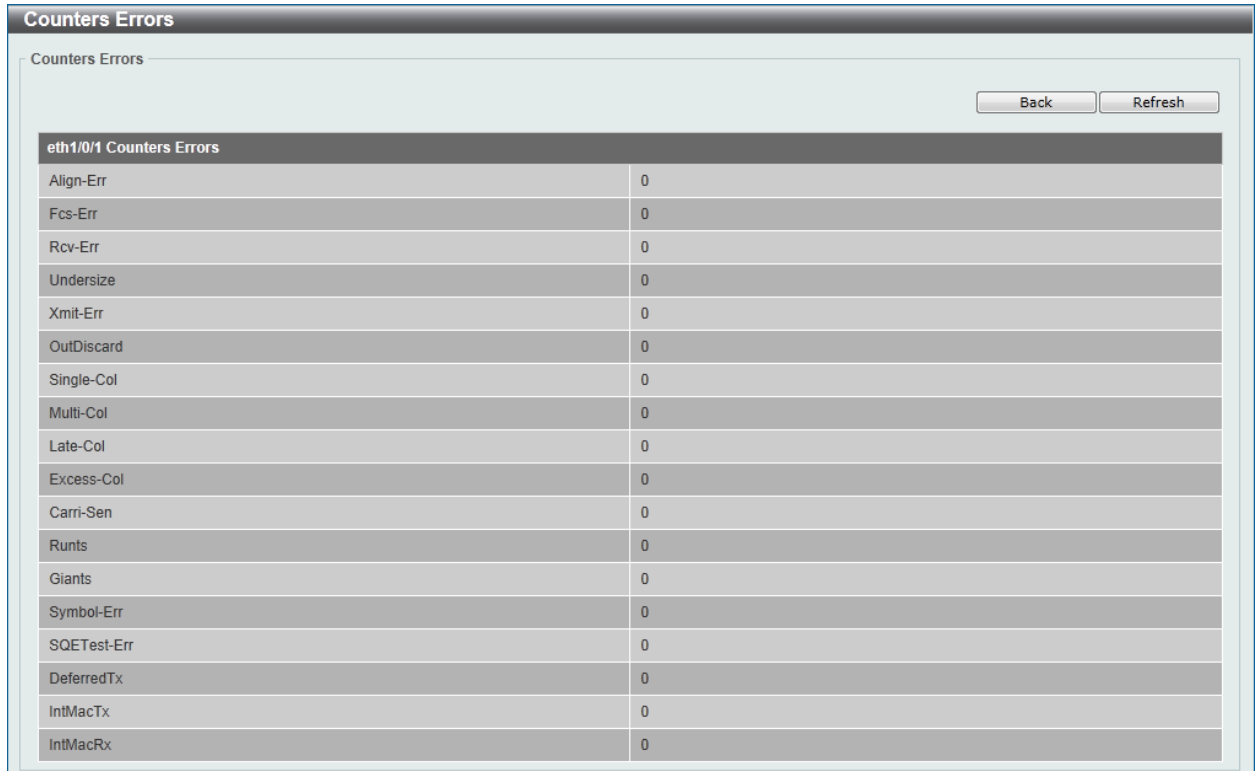

Counters Errors

Back Refresh

eth1/0/1 Counters Errors	
Align-Err	0
Fcs-Err	0
Rcv-Err	0
Undersize	0
Xmit-Err	0
OutDiscard	0
Single-Col	0
Multi-Col	0
Late-Col	0
Excess-Col	0
Carri-Sen	0
Runts	0
Giants	0
Symbol-Err	0
SQETest-Err	0
DeferredTx	0
IntMacTx	0
IntMacRx	0

Figure 11-5 Counters Errors window

Click the **Back** button to return to the previous window.

Click the **Refresh** button to refresh the display table.

Counters

This window is used to display all port counters, and clear the port counters of the specified or all ports.

To view the following window, click **Monitoring > Statistics > Counters**, as show below:

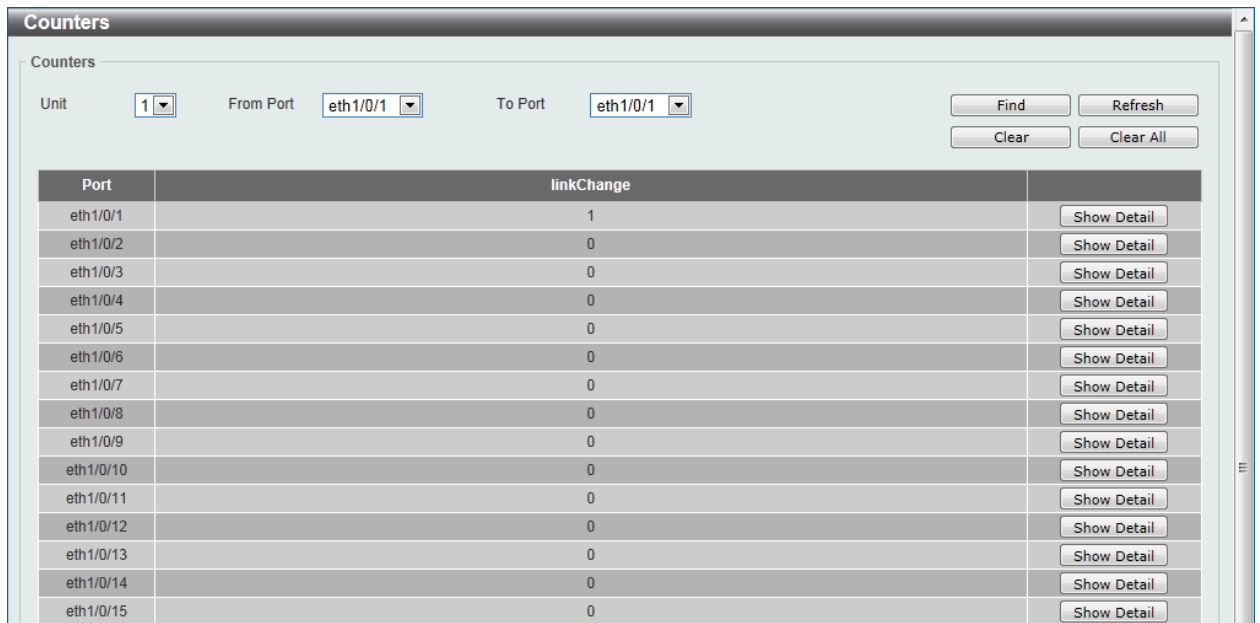

Figure 11-6 Counters window

The fields that can be configured are described below:

Parameter	Description
Unit	Select the switch unit that will be used for this configuration here.
From Port / To Port	Select the appropriate port range used for the configuration here.

Click the **Find** button to locate a specific entry based on the information entered.

Click the **Refresh** button to refresh the display table.

Click the **Clear** button to clear all the information for the specific ports.

Click the **Clear All** button to clear all the information in this table.

Click the **Show Detail** button to see the detail information of the specific port.

After clicking the **Show Detail** button, the following page will appear.

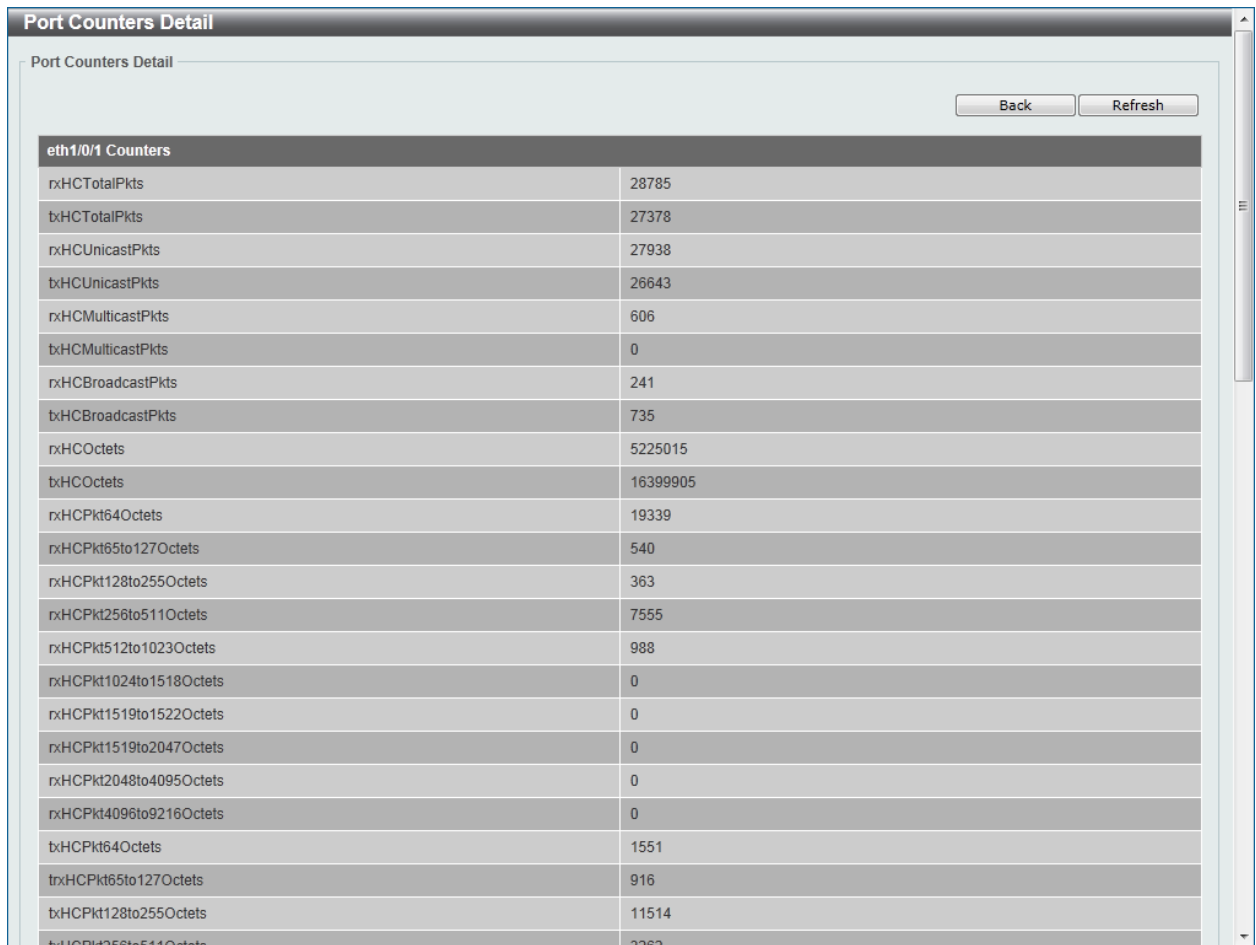

eth1/0/1 Counters	
rxHCTotalPkts	28785
txHCTotalPkts	27378
rxHCUnicastPkts	27938
txHCUnicastPkts	26643
rxHCMulticastPkts	606
txHCMulticastPkts	0
rxHCBroadcastPkts	241
txHCBroadcastPkts	735
rxHCOctets	5225015
txHCOctets	16399905
rxHCPkt64Octets	19339
rxHCPkt65to127Octets	540
rxHCPkt128to255Octets	363
rxHCPkt256to511Octets	7555
rxHCPkt512to1023Octets	988
rxHCPkt1024to1518Octets	0
rxHCPkt1519to1522Octets	0
rxHCPkt1519to2047Octets	0
rxHCPkt2048to4095Octets	0
rxHCPkt4096to9216Octets	0
txHCPkt64Octets	1551
txHCPkt65to127Octets	916
txHCPkt128to255Octets	11514
txHCPkt256to511Octets	2262

Figure 11-7 Port Counters Detail window

Click the **Back** button to return to the previous window.

Click the **Refresh** button to refresh the display table.

Mirror Settings

This window is used to view and configure the mirror feature's settings. The Switch allows users to copy frames transmitted and received on a port and redirect the copies to another port. Attach a monitoring device to the mirroring port, such as a sniffer or an RMON probe, to view details about the packets passing through the first port. This is useful for network monitoring and troubleshooting purposes.

To view the following window, click **Monitoring > Mirror Settings**, as shown below:

Mirror Settings

Mirror Settings

Session Number: 1

Destination: Port, Unit: 1, Port: eth1/0/1

Source: Port, Unit: 1, From Port: eth1/0/1, To Port: eth1/0/1, Frame Type: Both

Add Delete

Mirror Session Table

All Session 1 Find

Session Number	Session Type	Source			Destination port	
		Ports				Flow(ACL Name)
		Both	RX	TX		

Figure 11-8 Mirror Settings window

The fields that can be configured for **Mirror Settings** are described below:

Parameter	Description
Session Number	Select the mirror session number for this entry here. This number is between 1 and 4.
Destination	<p>Tick the checkbox, next to the Destination option, to configure the destination for this port mirror entry.</p> <p>In the first drop-down menu select the destination type option. Option to choose from is Port.</p> <p>After selecting the Port option, select the destination unit and port number from the second and third drop-down menu.</p>
Source	<p>Tick the checkbox, next to the Source option, to configure the source for this port mirror entry.</p> <p>In the first drop-down menu select the source type option. Options to choose from are Port, and ACL.</p> <p>After selecting the Port option, select the From Port number and the To Port number from the second and third drop-down menus. Lastly select the Frame Type option from the fourth drop-down menu. Options to choose from as the Frame Type are Both, RX, and TX. When selecting Both, traffic in both the incoming and outgoing directions will be mirrored. When selecting RX, traffic in only the incoming direction will be mirrored. When selecting TX, traffic in only the outgoing direction will be mirrored.</p> <p>After selecting the ACL option, enter the ACL profile name in the space provided.</p>

Click the **Add** button to add the newly configured mirror entry based on the information entered.

Click the **Delete** button to delete an existing mirror entry based on the information entered.

The fields that can be configured for **Mirror Session Table** are described below:

Parameter	Description
Mirror Session Type	Select the mirror session type of information that will be displayed from the drop-down menu. Options to choose from are All Session , and

Session Number.

After selecting the **Session Number** option, select the session number from the second drop-down menu. This number is from 1 to 4.

Click the **Find** button to locate a specific entry based on the information entered.

Device Environment

The device environment feature displays the Switch internal temperature status.

To view the following window, click **Monitoring > Device Environment**, as shown below:

Device Environment		
Detail Temperature Status		
Unit	Temperature Descr/ID	Current/Threshold Range
1	Central Temperature /1	27C/11~79C
Status code: * temperature is out of threshold range		
Detail Fan Status		
Items	Status	
Unit	1	
Right Fan 1	(OK)	
Right Fan 2	(OK)	
Detail Power Status		
Unit	Power Module	Power Status
1	Power 1	In-operation

Figure 11-9 Device Environment window

12. Green

Power Saving EEE

Power Saving

This window is used to configure the power saving settings of the Switch.

To view the following window, click **Green > Power Saving**, as shown below:

Figure 12-1 Power Saving window

The fields that can be configured are described below:

Parameter	Description
Link Detection Power Saving	Select this option to enable or disable the link detection state. When enabled, a port which has a link down status will be turned off to save power to the Switch. This will not affect the port's capabilities when the port status is link up.
Scheduled Port-shutdown Power Saving	Select this option to enable or disable applying the power saving by scheduled port shutdown.
Scheduled Hibernation Power Saving	Select this option to enable or disable the scheduled hibernation power saving feature. When this option is enabled, the system will enter into the hibernation mode based on the specified time range profile associated with it. When the system enters the hibernation mode, the switch will go into a low power state and idle. It will shut down all the ports and LEDs, all network function will be disabled, and only the console connection will work via the console port. If the Switch is an endpoint type Power Sourcing Equipment (PSE), the Switch will not provide power to the port.
Scheduled Dim-LED Power Saving	Select this option to enable or disable applying the power saving by scheduled dimming LEDs.
Administrative Dim-LED	Select this option to enable or disable the port LED function.
Type	Select the type of power saving. Options to choose from are Dim-LED and Hibernation .
Time Range	Enter the name of the time range to associate with the power saving type.

Click the **Apply** button to accept the changes made for each individual section.

Click the **Delete** button to remove the specified entry.



NOTE: The **hibernation** feature can only be configured when physical stacking is disabled on this switch.

After clicking the **Power Saving Shutdown Settings** tab, the following page will appear.

Figure 12-2 Power Saving Shutdown Settings window

The fields that can be configured are described below:

Parameter	Description
Unit	Select the switch unit that will be used for this configuration here.
From Port / To Port	Select the appropriate port range used for the configuration here.
Time Range	Enter the name of the time range to associated with the ports.

Click the **Apply** button to accept the changes made.

Click the **Delete** button to remove the specified entry.

EEE

Energy Efficient Ethernet (EEE) is defined in IEEE 802.3az. It is designed to reduce the energy consumption of a link when no packets are being sent.

To view the following window, click **Green > EEE**, as shown below:

EEE Settings

Unit: 1 From Port: eth1/0/1 To Port: eth1/0/1 State: Disabled

Unit 1 Settings

Port	State
eth1/0/1	Disabled
eth1/0/2	Disabled
eth1/0/3	Disabled
eth1/0/4	Disabled
eth1/0/5	Disabled
eth1/0/6	Disabled
eth1/0/7	Disabled
eth1/0/8	Disabled
eth1/0/9	Disabled
eth1/0/10	Disabled
eth1/0/11	Disabled
eth1/0/12	Disabled
eth1/0/13	Disabled
eth1/0/14	Disabled
eth1/0/15	Disabled
eth1/0/16	Disabled
eth1/0/17	Disabled

Figure 12-3 EEE window

The fields that can be configured are described below:

Parameter	Description
Unit	Select the switch unit that will be used for this configuration here.
From Port / To Port	Select the appropriate port range used for the configuration here.
State	Select this option to enable or disable the state of this feature here.

Click the **Apply** button to accept the changes made.

13. Save and Tools

Save Configuration
Firmware Upgrade & Backup
Configuration Restore & Backup
Log Backup
Ping
Trace Route
Language Management
Reset
Reboot System

Save Configuration

This window is used to save the running configuration to the start-up configuration or the file system of the Switch. This is to prevent the loss of configuration in the event of a power failure.

To view the following window, click **Save > Save Configuration**, as shown below:

Figure 13-1 Save Configuration window

The fields that can be configured are described below:

Parameter	Description
Unit	Select the switch unit that will be used for this configuration here.
File Path	Enter the filename and path in the space provided.

Click the **Apply** button to save the configuration.

Firmware Upgrade & Backup

Firmware Upgrade from HTTP

This window is used to initiate a firmware upgrade from a local PC using HTTP.

To view the following window, click **Tools > Firmware Upgrade & Backup > Firmware Upgrade from HTTP**, as shown below:

Figure 13-2 Firmware Upgrade from HTTP window

The fields that can be configured are described below:

Parameter	Description
Unit	Select the switch unit that will be used for this configuration here.
Source URL	Enter the source filename and path of the firmware file located on the local PC. This field can be up to 64 characters long. Alternatively click the Browse button to navigate to the location of the firmware file located on the local PC.
Destination URL	Enter the destination path and location where the new firmware should be stored on the Switch. This field can be up to 64 characters long.

Click the **Upgrade** button to initiate the firmware upgrade.

Firmware Upgrade from TFTP

This window is used to initiate a firmware upgrade from a TFTP server.

To view the following window, click **Tools > Firmware Upgrade & Backup > firmware Upgrade from TFTP**, as shown below:

Figure 13-3 Firmware Upgrade from TFTP window

The fields that can be configured are described below:

Parameter	Description
Unit	Select the switch unit that will be used for this configuration here.
TFTP Server IP	Enter the TFTP server's IP address here. When select the IPv4 option, enter the IPv4 address of the TFTP server in the space provided. When the IPv6 option is selected, enter the IPv6 address of the TFTP server in the space provided.
Source URL	Enter the source filename and path of the firmware file located on the TFTP server here. This field can be up to 64 characters long.
Destination URL	Enter the destination path and location where the new firmware should be stored on the Switch. This field can be up to 64 characters long.

Click the **Upgrade** button to initiate the firmware upgrade.

Firmware Backup to HTTP

This window is used to initiate a firmware backup to a local PC using HTTP.

To view the following window, click **Tools > Firmware Upgrade & Backup > Firmware Backup to HTTP**, as shown below:

Figure 13-4 Firmware Backup to HTTP window

The fields that can be configured are described below:

Parameter	Description
Unit	Select the switch unit that will be used for this configuration here.
Source URL	Enter the source filename and path of the firmware file located on the Switch here. This field can be up to 64 characters long.

Click the **Backup** button to initiate the firmware backup.

Firmware Backup to TFTP

This window is used to initiate a firmware backup to a TFTP server.

To view the following window, click **Tools > Firmware Upgrade & Backup > Firmware Backup to TFTP**, as shown below:

Figure 13-5 Firmware Backup to TFTP window

The fields that can be configured are described below:

Parameter	Description
Unit	Select the switch unit that will be used for this configuration here.
TFTP Server IP	Enter the TFTP server's IP address here. When select the IPv4 option, enter the IPv4 address of the TFTP server in the space provided. When the IPv6 option is selected, enter the IPv6 address of the TFTP server in the space provided.
Source URL	Enter the source filename and path of the firmware file located on the Switch here. This field can be up to 64 characters long.

Click the **Backup** button to initiate the firmware backup.

Configuration Restore & Backup

Configuration Restore from HTTP

This window is used to initiate a configuration restore from a local PC using HTTP.

To view the following window, click **Tools > Configuration Restore & Backup > Configuration Restore from HTTP**, as shown below:

Figure 13-6 Configuration Restore from HTTP window

The fields that can be configured are described below:

Parameter	Description
Unit	Select the switch unit that will be used for this configuration here.
Source URL	Enter the source filename and path of the configuration file located on the local PC. This field can be up to 64 characters long. Alternatively click the Browse button to navigate to the location of the configuration file located on the local PC.
Destination URL	Enter the destination path and location where the configuration file should be stored on the Switch. This field can be up to 64 characters long. Select the running-config option to restore and overwrite the running configuration file on the Switch. Select the startup-config option to restore and overwrite the start-up configuration file on the Switch.
Replace	Select this option to replace the current running configuration.

Click the **Restore** button to initiate the configuration restore.

Configuration Restore from TFTP

This window is used to initiate a configuration restore from a TFTP server.

To view the following window, click **Tools > Configuration Restore & Backup > Configuration Restore from TFTP**, as shown below:

Figure 13-7 Configuration Restore from TFTP window

The fields that can be configured are described below:

Parameter	Description
Unit	Select the switch unit that will be used for this configuration here.
TFTP Server IP	Enter the TFTP server's IP address here. When select the IPv4 option, enter the IPv4 address of the TFTP server in the space provided. When the IPv6 option is selected, enter the IPv6 address of the TFTP

	server in the space provided.
Source URL	Enter the source filename and path of the configuration file located on the TFTP server here. This field can be up to 64 characters long.
Destination URL	Enter the destination path and location where the configuration file should be stored on the Switch. This field can be up to 64 characters long. Select the running-config option to restore and overwrite the running configuration file on the Switch. Select the startup-config option to restore and overwrite the start-up configuration file on the Switch.
Replace	Select this option to replace the current running configuration.

Click the **Restore** button to initiate the configuration restore.

Configuration Backup to HTTP

This window is used to initiate a configuration file backup to a local PC using HTTP.

To view the following window, click **Tools > Configuration Restore & Backup > Configuration Backup to HTTP**, as shown below:

Figure 13-8 Configuration Backup to HTTP window

The fields that can be configured are described below:

Parameter	Description
Unit	Select the switch unit that will be used for this configuration here.
Source URL	Enter the source filename and path of the configuration file located on the Switch here. This field can be up to 64 characters long. Select the running-config option to back up the running configuration file from the Switch. Select the startup-config option to back up the start-up configuration file from the Switch.

Click the **Backup** button to initiate the configuration file backup.

Configuration Backup to TFTP

This window is used to initiate a configuration file backup to a TFTP server.

To view the following window, click **Tools > Configuration Restore & Backup > Configuration Backup to TFTP**, as shown below:

Figure 13-9 Configuration Backup to TFTP window

The fields that can be configured are described below:

Parameter	Description
Unit	Select the switch unit that will be used for this configuration here.
TFTP Server IP	Enter the TFTP server's IP address here. When select the IPv4 option, enter the IPv4 address of the TFTP server in the space provided. When the IPv6 option is selected, enter the IPv6 address of the TFTP server in the space provided.
Source URL	Enter the source filename and path of the configuration file located on the switch here. This field can be up to 64 characters long. Select the running-config option to back up the running configuration file from the Switch. Select the startup-config option to back up the start-up configuration file from the Switch.
Destination URL	Enter the destination path and location where the configuration file should be stored on the TFTP server. This field can be up to 64 characters long.

Click the **Backup** button to initiate the configuration file backup.

Log Backup

Log Backup to HTTP

This window is used to initiate a system log backup to a local PC using HTTP.

To view the following window, click **Tools > Log Backup > Log Backup to HTTP**, as shown below:

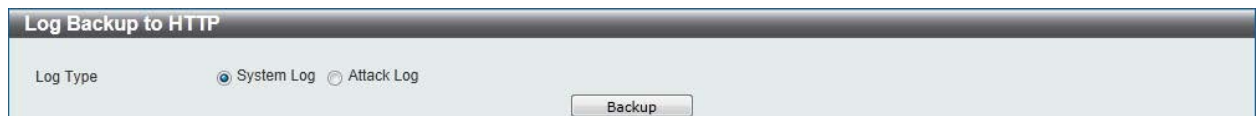

Figure 13-10 Log Backup to HTTP window

The fields that can be configured are described below:

Parameter	Description
Log Type	Select the log type that will be backed up to the local PC using HTTP. When the System Log option is selected, the system log will be backed up. When the Attack Log is selected, the attack log will be backed up.

Click the **Backup** button to initiate the system log backup.

Log Backup to TFTP

This window is used to initiate a system log backup to a TFTP server.

To view the following window, click **Tools > Log Backup > Log Backup to TFTP**, as shown below:

Figure 13-11 Log Backup to TFTP window

The fields that can be configured are described below:

Parameter	Description
TFTP Server IP	Enter the TFTP server’s IP address here. When select the IPv4 option, enter the IPv4 address of the TFTP server in the space provided. When the IPv6 option is selected, enter the IPv6 address of the TFTP server in the space provided.
Destination URL	Enter the destination path and location where the log file should be stored on the TFTP server. This field can be up to 64 characters long.
Log Type	Select the log type that will be backed up to the TFTP server. When the System Log option is selected, the system log will be backed up. When the Attack Log is selected, the attack log will be backed up.

Click the **Backup** button to initiate the system log backup.

Ping

Ping is a small program that sends ICMP Echo packets to the IP address you specify. The destination node then responds to or “echoes” the packets sent from the Switch. This is very useful to verify connectivity between the Switch and other nodes on the network.

To view the following window, click **Tools > Ping**, as shown below:

Figure 13-12 Ping window

The fields that can be configured for **IPv4 Ping** are described below:

Parameter	Description
-----------	-------------

Target IPv4 Address	Select and enter an IP address to be pinged.
Domain Name	Select and enter the domain name of the system to discover.
Ping Times	Enter the number of times desired to attempt to Ping the IPv4 address configured in this window. Users may enter a number of times between 1 and 255. Tick the Infinite check box to keep sending ICMP Echo packets to the specified IP address until the program is stopped.
Timeout	Select a timeout period between 1 and 99 seconds for this Ping message to reach its destination. If the packet fails to find the IP address in this specified time, the Ping packet will be dropped.
Source IPv4 Address	Enter the source IPv4 address. If the current switch has more than one IP address, you can enter one of them to this field. When entered, this IPv4 address will be used as the packets' source IP address sent to the remote host, or as primary IP address.

The fields that can be configured for **IPv6 Ping** are described below:

Parameter	Description
Target IPv6 Address	Enter an IPv6 address to be pinged.
Ping Times	Enter the number of times desired to attempt to Ping the IPv6 address configured in this window. Users may enter a number of times between 1 and 255. Tick the Infinite check box to keep sending ICMP Echo packets to the specified IPv6 address until the program is stopped.
Timeout	Select a timeout period between 1 and 99 seconds for this Ping message to reach its destination. If the packet fails to find the IP address in this specified time, the Ping packet will be dropped.
Source IPv6 Address	Enter the source IPv6 address. If the current switch has more than one IPv6 address, you can enter one of them to this field. When entered, this IPv6 address will be used as the packets' source IP address sent to the remote host, or as primary IP address.

Click the **Start** button to initiate the Ping Test for each individual section.

After clicking the **Start** button in **IPv4 Ping** section, the following **IPv4 Ping Result** section will appear:

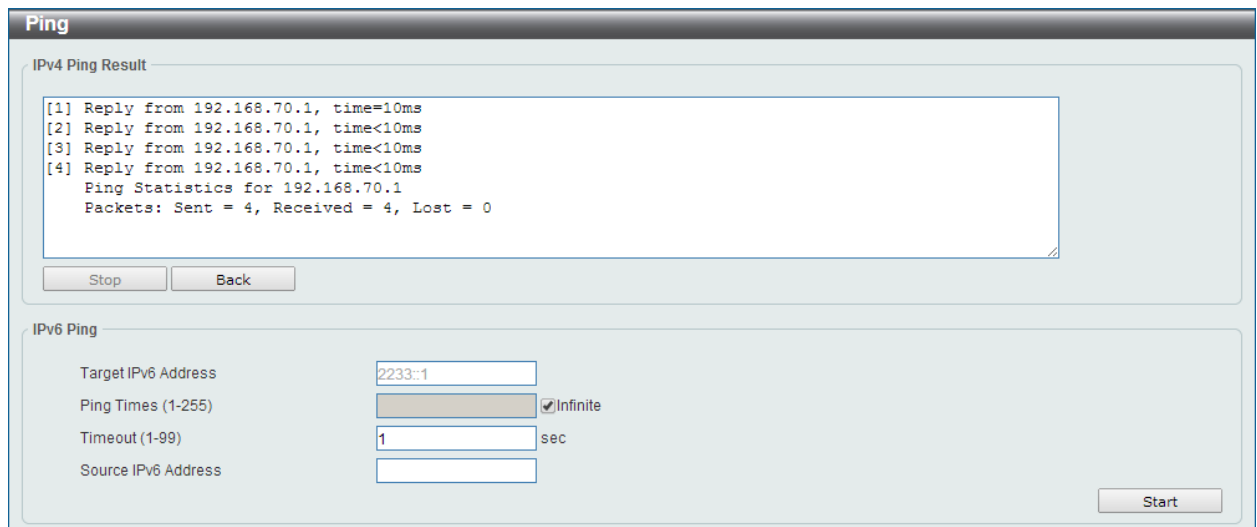

Figure 13-13 Ping - IPv4 Ping Result window

Click the **Stop** button to halt the Ping Test.

Click the **Back** button to return to the IPv4 Ping section.

After clicking the **Start** button in **IPv6 Ping** section, the following **IPv6 Ping Result** section will appear:

Ping

IPv4 Ping

Target IPv4 Address

Domain Name

Ping Times (1-255) Infinite

Timeout (1-99) sec

Source IPv4 Address

IPv6 Ping Result

```
[1] Reply from 2014::4, bytes=100 time<10 ms
[2] Reply from 2014::4, bytes=100 time<10 ms
[3] Reply from 2014::4, bytes=100 time<10 ms
[4] Reply from 2014::4, bytes=100 time<10 ms
Ping Statistics for 2014::4
Packets: Sent =4, Received =4, Lost =0
```

Figure 13-14 Ping – IPv6 Ping Result window

Click the **Stop** button to halt the Ping Test.

Click the **Back** button to return to the IPv4 Ping section.

Trace Route

The trace route page allows the user to trace a route between the Switch and a given host on the network.

To view the following window, click **Tools > Trace Route**, as shown below:

Trace Route

IPv4 Trace Route

IPv4 Address

Domain Name

Max TTL (1-60)

Port (30000-64900)

Timeout (1-65535) sec

Probe Times (1-9)

IPv6 Trace Route

IPv6 Address

Max TTL (1-60)

Port (30000-64900)

Timeout (1-65535) sec

Probe Times (1-9)

Figure 13-15 Trace Route window

The fields that can be configured for **IPv4 Trace Route** are described below:

Parameter	Description
IPv4 Address	Select and enter the IPv4 address of the destination here.
Domain Name	Select and enter the domain name of the destination here.
Max TTL	Enter the Time-To-Live (TTL) value of the trace route request here. This is the maximum number of routers that a trace route packet can pass. The trace route option will cross while seeking the network path between two devices. The range for the TTL is 1 to 60 hops.
Port	Enter the port number here. The value range is from 30000 to 64900.
Timeout	Enter the timeout period while waiting for a response from the remote device here. A value of 1 to 65535 seconds can be specified. The default is 5 seconds.
Probe Times	Enter the probe time number here. The range is from 1 to 9. If unspecified, the default value is 1.

The fields that can be configured for **IPv6 Trace Route** are described below:

Parameter	Description
IPv6 Address	Select and enter the IPv6 address of the destination here.
Max TTL	Enter the Time-To-Live (TTL) value of the trace route request here. This is the maximum number of routers that a trace route packet can pass. The trace route option will cross while seeking the network path between two devices. The range for the TTL is 1 to 60 hops.
Port	Enter the port number here. The value range is from 30000 to 64900.
Timeout	Enter the timeout period while waiting for a response from the remote device here. A value of 1 to 65535 seconds can be specified. The default is 5 seconds.
Probe Times	Enter the probe time number here. The range is from 1 to 9. If unspecified, the default value is 1.

Click the **Start** button to initiate the route trace for each individual section.

After clicking the **Start** button in **IPv4 Trace Route** section, the following **IPv4 Trace Route Result** section will appear:

Trace Route

IPv4 Trace Route Result

```
[1] <10 ms    192.168.249.134
[2] <10 ms    10.1.1.254
[3] <10 ms    192.168.249.134
[4] <10 ms    192.168.5.230
[5] <10 ms    [211.21.180.1]
Trace complete
```

Back

IPv6 Trace Route

IPv6 Address

Max TTL (1-60)

Port (30000-64900)

Timeout (1-65535) sec

Probe Times (1-9)

Start

Figure 13-16 Trace Route - IPv4 Trace Route Result window

Click the **Back** button to stop the trace route and return to the IPv4 Trace Route section.

Language Management

This window is used to install the language file to the Switch.

To view the following window, click **Tools > Language Management**, as shown below:

Language Management

Language File Browse...

Apply

Figure 13-17 Language Management window

The fields that can be configured are described below:

Parameter	Description
Language File	Click the Browse button to navigate to the location of the firmware file located on the local PC.

Click the **Apply** button to initiate the language pack installation.

Reset

This window is used to reset the Switch's configuration to the factory default settings.

To view the following window, click **Tools > Reset**, as shown below:

Reset

Reset

The Switch will be reset to its factory defaults including IP address and stacking information, and then will save, reboot.

The Switch will be reset to its factory defaults except IP address, and then will save, reboot.

The Switch will be reset to its factory defaults including IP address.

Apply

Figure 13-18 Reset window

Select the **The Switch will be reset to its factory defaults including IP address and stacking information, and the will save, reboot** option to reset the Switch's configuration to its factory default settings.

Select the **The Switch will be reset to its factory default except IP address, and then will save, reboot** option to reset the Switch's configuration to its factory default settings. This option will exclude the IP address from being changed.

Select the **The Switch will be reset to its factory defaults including IP address** option to reset the Switch's configuration to its factory default settings.

Click the **Apply** button to initiate the factory default reset and reboot the Switch.

Reboot System

This window is used to reboot the Switch and alternatively save the configuration before doing so. To view the following window, click **Tools > Reboot System**, as shown below:

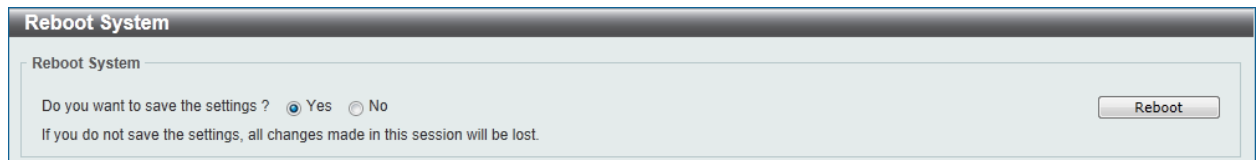

Figure 13-19 Reboot System window

When rebooting the Switch, any configuration changes that was made during this session, will be lost unless the **Yes** option is selected when asked to save the settings.

Click the **Reboot** button to alternatively save the settings and reboot the Switch.

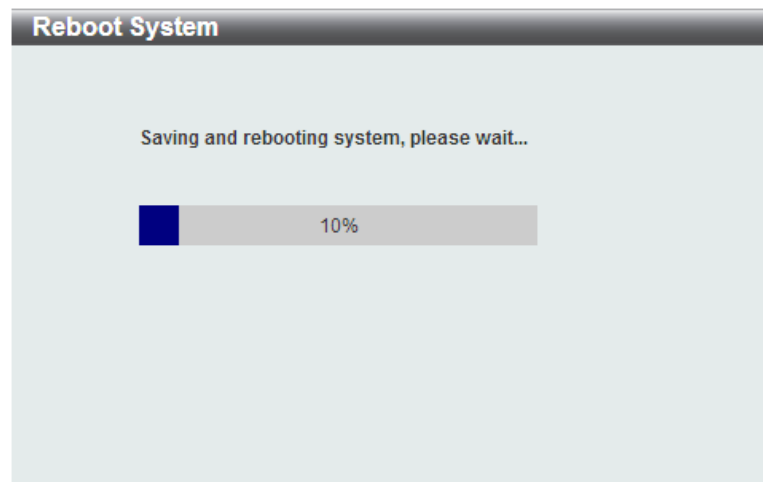

Figure 13-20 Reboot System - Rebooting window

Appendix A - System Log Entries

The following table lists all possible entries and their corresponding meanings that will appear in the System Log of this switch.

802.1X

Log Description	Severity
<p>Event description: 802.1X Authentication failure.</p> <p>Log Message: 802.1X authentication fail [due to <reason>] from (Username: <username>, <interface-id>, MAC: <mac-address>)</p> <p>Parameters description:</p> <p>reason: The reason for the failed authentication. The possible reason may be:</p> <ul style="list-style-type: none"> (1) user authentication failure. (2) no server(s) responding. (3) no servers configured. (4) no resources. (5) user timeout expired. <p>username: The user that is being authenticated..</p> <p>interface-id: The switch interface number.</p> <p>mac-address: The MAC address of the authenticated device.</p>	Critical
<p>Event description:802.1X fails to work due to H/W ACL resource is exhausted.</p> <p>Log Message: 802.1X cannot work correctly because ACL rule resource is not available.</p>	Alert
<p>Event description: 802.1X Authentication successful.</p> <p>Log Message: 802.1X authentication success (Username: <username>, <interface-id>, MAC: <mac-address>)</p> <p>Parameters description:</p> <p>username: The user that is being authenticated.</p> <p>interface-id: The interface name.</p> <p>mac-address: The MAC address of the authenticated device.</p>	Informational

AAA

Log Description	Severity
<p>Event description: This log will be generated when AAA global state is enabled or disabled.</p> <p>Log Message: AAA is <status>.</p> <p>Parameters description:</p> <p>status: The status indicates the AAA enabled or disabled.</p>	Informational
<p>Event description: This log will be generated when login successfully.</p> <p>Log Message: Successful login through <exec-type> <from client-ip> authenticated by AAA <aaa-method> <server-ip> (Username: <username>).</p> <p>Parameters description:</p> <p>exec-type: It indicates the EXEC types, e.g.: Console, Telnet, SSH, Web, Web(SSL).</p>	Informational

<p>client-ip: It indicates the client's IP address if valid through IP protocol.</p> <p>aaa-method: It indicates the authentication method, e.g.: none, local, server.</p> <p>server-ip: It indicates the AAA server IP address if authentication method is remote server.</p> <p>Username: It indicates the username for authentication.</p>	
<p>Event description: This log will be generated when login failure.</p> <p>Log Message: Login failed through <exec-type> <from client-ip> authenticated by AAA <aaa-method> <server-ip> (Username: <username>).</p> <p>Parameters description:</p> <p>exec-type: It indicates the EXEC types, e.g.: Console, Telnet, SSH, Web, Web(SSL).</p> <p>client-ip: It indicates the client's IP address if valid through IP protocol.</p> <p>aaa-method: It indicates the authentication method, e.g.: local, server.</p> <p>server-ip: It indicates the AAA server IP address if authentication method is remote server.</p> <p>username: It indicates the username for authentication.</p>	Warning
<p>Event description: This log will be generated when the remote server does not respond to the login authentication request.</p> <p>Log Message: Login failed through <exec-type> <from client-ip> due to AAA server <server-ip> timeout (Username: <username>).</p> <p>Parameters description:</p> <p>exec-type: It indicates the EXEC types, e.g.: Console, Telnet, SSH, Web, Web(SSL).</p> <p>client-ip: It indicates the client's IP address if valid through IP protocol.</p> <p>server-ip: It indicates the AAA server IP address.</p> <p>username: It indicates the username for authentication.</p>	Warning
<p>Event description: This log will be generated when enable privilege successfully.</p> <p>Log Message: Successful enable privilege through <exec-type> <from client-ip> authenticated by AAA <aaa-method> <server-ip> (Username: <username>).</p> <p>Parameters description:</p> <p>exec-type: It indicates the EXEC types, e.g.: Console, Telnet, SSH, Web, Web(SSL).</p> <p>client-ip: It indicates the client's IP address if valid through IP protocol.</p> <p>aaa-method: It indicates the authentication method, e.g.: none, local, server.</p> <p>server-ip: It indicates the AAA server IP address if authentication method is remote server.</p> <p>Username: It indicates the username for authentication.</p>	Informational
<p>Event description: This log will be generated when enable privilege failure.</p> <p>Log Message: Enable privilege failed through <exec-type> <from client-ip> authenticated by AAA <aaa-method> <server-ip> (Username: <username>).</p> <p>Parameters description:</p> <p>exec-type: It indicates the EXEC types, e.g.: Console, Telnet, SSH, Web, Web(SSL).</p> <p>client-ip: It indicates the client's IP address if valid through IP protocol.</p> <p>aaa-method: It indicates the authentication method, e.g.: local, server.</p> <p>server-ip: It indicates the AAA server IP address if authentication method is remote server.</p> <p>username: It indicates the username for authentication.</p>	Warning

<p>Event description: This log will be generated when the remote server does not respond to the enable password authentication request.</p> <p>Log Message: Enable privilege failed through <exec-type> <from client-ip> due to AAA server <server-ip> timeout (Username: <username>).</p> <p>Parameters description:</p> <ul style="list-style-type: none"> exec-type: It indicates the EXEC types, e.g.: Console, Telnet, SSH, Web, Web(SSL). client-ip: It indicates the client's IP address if valid through IP protocol. server-ip: It indicates the AAA server IP address. username: It indicates the username for authentication. 	Warning
<p>Event description: This log will be generated when RADIUS assigned a valid VLAN ID attributes.</p> <p>Log Message: RADIUS server <server-ip> assigned VID: <vid> to port <interface-id> (Username: <username>)</p> <p>Parameters description:</p> <ul style="list-style-type: none"> server-ip: It indicates the RADIUS server IP address. vid: The assign VLAN ID that authorized by from RADIUS server. interface-id: It indicates the port number of the client authenticated. Username: It indicates the username for authentication. 	Informational
<p>Event description: This log will be generated when RADIUS assigned a valid bandwidth attributes.</p> <p>Log Message: RADIUS server <server-ip> assigned <direction> bandwidth: <threshold> to port < interface -id> (Username: <username>)</p> <p>Parameters description:</p> <ul style="list-style-type: none"> server-ip: It indicates the RADIUS server IP address. Direction: It indicates the direction for bandwidth control, e.g.: ingress or egress. Threshold: The assign threshold of bandwidth that authorized by from RADIUS server. Interface-id: It indicates the port number of the client authenticated. Username: It indicates the username for authentication. 	Informational
<p>Event description: This log will be generated when RADIUS assigned a valid priority attributes.</p> <p>Log Message: RADIUS server <server-ip> assigned 802.1p default priority: <priority> to port < interface -id> (Username: <username>)</p> <p>Parameters description:</p> <ul style="list-style-type: none"> server-ip: It indicates the RADIUS server IP address. priority: The assign priority that authorized by from RADIUS server. interface-id: It indicates the port number of the client authenticated. Username: It indicates the username for authentication. 	Informational
<p>Event description: This log will be generated when RADIUS assigned ACL script but fails to apply to the system due to insufficient resource.</p> <p>Log Message: RADIUS server <server-ip> assigns <username> ACL failure at port < interface -id> (<acl-script>)</p> <p>Parameters description:</p> <ul style="list-style-type: none"> server-ip: It indicates the RADIUS server IP address. username: It indicates the username for authentication. interface-id: It indicates the port number of the client authenticated. acl-script: The assign ACL script that authorized by from RADIUS server. 	Warning

Auto Surveillance VLAN

Log Description	Severity
<p>Event description: When a new surveillance device is detected on an interface.</p> <p>Log Message: New surveillance device detected (<interface-id>, MAC: < mac-address >)</p> <p>Parameters description:</p> <p> interface-id: Interface name.</p> <p> mac-address: Surveillance device MAC address.</p>	Informational
<p>Event description: When an interface which is enabled surveillance VLAN joins the surveillance VLAN automatically.</p> <p>Log Message: <interface-id> add into surveillance VLAN <vid ></p> <p>Parameters description:</p> <p> interface-id: Interface name.</p> <p> vid:VLAN ID</p>	Informational
<p>Event description: When an interface leaves the surveillance VLAN and at the same time, no surveillance device is detected in the aging interval for that interface, the log message will be sent.</p> <p>Log Message: <interface-id> remove from surveillance VLAN <vid ></p> <p>Parameters description:</p> <p> interface-id: Interface name.</p> <p> vid:VLAN ID</p>	Informational

BPDU Attack Protection

Log Description	Severity
<p>Event description: Record the event when the BPDU attack happened.</p> <p>Log Message: <interface-id> enter STP BPDU under protection state (mode: <mode>)</p> <p>Parameters description:</p> <p> interface-id: Interface on which detected STP BPDU attack.</p> <p> mode: BPDU Protection mode of the interface. Mode can be drop, block, or shutdown</p>	Informational
<p>Event description: Record the event when the STP BPDU attack recovered.</p> <p>Log Message: <interface-id> recover from BPDU under protection state.</p> <p>Parameters description:</p> <p> interface-id: Interface on which detected STP BPDU attack.</p>	Informational

Configuration/Firmware

Log Description	Severity
<p>Event description: Firmware upgraded successfully.</p> <p>Log Message: [Unit <unitID>,]Firmware upgraded by <session> successfully (Username: <username>[, IP: <ipaddr>, MAC: <macaddr>], Server IP: <serverIP>, File Name: <pathFile>)</p> <p>Parameters description:</p>	Informational

<p>unitID: The unit ID. session: The user's session. username: Represent current login user. ipaddr: Represent client IP address. macaddr : Represent client MAC address. serverIP: Server IP address. pathFile: Path and file name on server.</p>	
<p>Event description: Firmware upgraded unsuccessfully.</p> <p>Log Message: [Unit <unitID>,]Firmware upgraded by <session> unsuccessfully (Username: <username>[, IP: <ipaddr>, MAC: <macaddr>], Server IP: <serverIP>, File Name: <pathFile>)</p> <p>Parameters description: unitID: The unit ID. session: The user's session. username: Represent current login user. ipaddr: Represent client IP address. macaddr : Represent client MAC address. serverIP: Server IP address. pathFile: Path and file name on server.</p>	Warning
<p>Event description: Firmware uploaded successfully.</p> <p>Log Message: [Unit <unitID>,]Firmware uploaded by <session> successfully (Username: <username>[, IP: <ipaddr>, MAC: <macaddr>], Server IP: <serverIP>, File Name: <pathFile>)</p> <p>Parameters description: unitID: The unit ID. session: The user's session. username: Represent current login user. ipaddr: Represent client IP address. macaddr : Represent client MAC address. serverIP: Server IP address. pathFile: Path and file name on server.</p>	Informational
<p>Event description: Firmware uploaded unsuccessfully.</p> <p>Log Message: [Unit <unitID>,]Firmware uploaded by <session> unsuccessfully (Username: <username>[, IP: <ipaddr>, MAC: <macaddr>], Server IP: <serverIP>, File Name: <pathFile>)</p> <p>Parameters description: unitID: The unit ID. session: The user's session. username: Represent current login user. ipaddr: Represent client IP address. macaddr : Represent client MAC address. serverIP: Server IP address. pathFile: Path and file name on server.</p>	Warning
<p>Event description: Configuration downloaded successfully.</p> <p>Log Message: [Unit <unitID>,]Configuration downloaded by <session> successfully. (Username: <username>[, IP: <ipaddr>, MAC: <macaddr>], Server IP: <serverIP>, File Name: <pathFile>)</p> <p>Parameters description: unitID: The unit ID.</p>	Informational

<p>session: The user's session. username: Represent current login user. ipaddr: Represent client IP address. macaddr : Represent client MAC address. serverIP: Server IP address. pathFile: Path and file name on server.</p>	
<p>Event description: Configuration downloaded unsuccessfully. Log Message: [Unit <unitID>,]Configuration downloaded by <session> unsuccessfully. (Username: <username>[, IP: <ipaddr>, MAC: <macaddr>], Server IP: <serverIP>, File Name: <pathFile>) Parameters description: unitID: The unit ID. session: The user's session. username: Represent current login user. ipaddr: Represent client IP address. macaddr : Represent client MAC address. serverIP: Server IP address. pathFile: Path and file name on server.</p>	Warning
<p>Event description: Configuration uploaded successfully. Log Message: [Unit <unitID>,]Configuration uploaded by <session> successfully. (Username: <username>[, IP: <ipaddr>, MAC: <macaddr>], Server IP: <serverIP>, File Name: <pathFile>) Parameters description: unitID: The unit ID. session: The user's session. username: Represent current login user. ipaddr: Represent client IP address. macaddr : Represent client MAC address. serverIP: Server IP address. pathFile: Path and file name on server.</p>	Informational
<p>Event description: Configuration uploaded unsuccessfully. Log Message: [Unit <unitID>,] Configuration uploaded by <session> unsuccessfully. (Username: <username>[, IP: <ipaddr>, MAC: <macaddr>], Server IP: <serverIP>, File Name: <pathFile>) Parameters description: unitID: The unit ID. session: The user's session. username: Represent current login user. ipaddr: Represent client IP address. macaddr : Represent client MAC address. serverIP: Server IP address. pathFile: Path and file name on server.</p>	Warning

DAI

Log Description	Severity
<p>Event description: This log will be generated when DAI detect invalid ARP packet. Log Message: Illegal ARP <type> packets (IP: <ip-address>, MAC: <mac-</p>	Warning

address>, VLAN <vlan-id>, on <interface-id>).

Parameters description:

type: The type of ARP packet, it indicates that ARP packet is request or ARP response.

Event description: This log will be generated when DAI detect valid ARP packet. Informational

Log Message: Legal ARP <type> packets (IP: <ip-address>, MAC: <mac-address>, VLAN <vlan-id>, on <interface-id>).

Parameters description:

type: The type of ARP packet, it indicates that ARP packet is request or ARP response.

DDM

Log Description	Severity
<p>Event description: when the any of SFP parameters exceeds from the warning threshold.</p> <p>Log Message: Optical transceiver <interface-id> <component> <high-low> warning threshold exceeded.</p> <p>Parameters description:</p> <ul style="list-style-type: none"> interface-id: port interface ID. component: DDM threshold type. It can be one of the following types: <ul style="list-style-type: none"> temperature supply voltage bias current TX power RX power high-low: High or low threshold. 	Warning
<p>Event description: when the any of SFP parameters exceeds from the alarm threshold.</p> <p>Log Message: Optical transceiver <interface-id> <component> <high-low> alarm threshold exceeded.</p> <p>Parameters description:</p> <ul style="list-style-type: none"> interface-id: port interface ID. component: DDM threshold type. It can be one of the following types: <ul style="list-style-type: none"> temperature supply voltage bias current TX power RX power high-low: High or low threshold. 	Critical
<p>Event description: when the any of SFP parameters recovers from the warning threshold.</p> <p>Log Message: Optical transceiver <interface-id> <component> <high-low> warning threshold exceeding back to normal.</p> <p>Parameters description:</p> <ul style="list-style-type: none"> interface-id: port interface ID. component: DDM threshold type. It can be one of the following types: <ul style="list-style-type: none"> temperature 	Warning

<p>supply voltage</p> <p>bias current</p> <p>TX power</p> <p>RX power</p> <p>high-low: High or low threshold.</p>	
<p>Event description: when the any of SFP parameters recovers from the alarm threshold.</p> <p>Log Message: Optical transceiver <interface-id> <component> <high-low> alarm threshold exceeding back to normal.</p> <p>Parameters description:</p> <p>interface-id: port interface ID.</p> <p>component: DDM threshold type. It can be one of the following types:</p> <p>temperature</p> <p>supply voltage</p> <p>bias current</p> <p>TX power</p> <p>RX power</p> <p>high-low: High or low threshold.</p>	Critical

DHCPv6 Client

Log Description	Severity
<p>Event description: DHCPv6 client interface administrator state changed.</p> <p>Log Message: DHCPv6 client on interface <ipif-name> changed state to [enabled disabled].</p> <p>Parameters description:</p> <p><ipif-name>: Name of the DHCPv6 client interface.</p>	Informational
<p>Event description: DHCPv6 client obtains an ipv6 address from a DHCPv6 server.</p> <p>Log Message: DHCPv6 client obtains an ipv6 address < ipv6address > on interface <ipif-name>.</p> <p>Parameters description:</p> <p>ipv6address: ipv6 address obtained from a DHCPv6 server.</p> <p>ipif-name: Name of the DHCPv6 client interface.</p>	Informational
<p>Event description: The ipv6 address obtained from a DHCPv6 server starts renewing.</p> <p>Log Message: The IPv6 address < ipv6address > on interface <ipif-name> starts renewing.</p> <p>Parameters description:</p> <p>ipv6address: ipv6 address obtained from a DHCPv6 server.</p> <p>ipif-name: Name of the DHCPv6 client interface.</p>	Informational
<p>Event description: The ipv6 address obtained from a DHCPv6 server renews success.</p> <p>Log Message: The IPv6 address < ipv6address > on interface <ipif-name> renews success.</p> <p>Parameters description:</p> <p>ipv6address: ipv6 address obtained from a DHCPv6 server.</p> <p>ipif-name: Name of the DHCPv6 client interface.</p>	Informational
<p>Event description: The ipv6 address obtained from a DHCPv6 server starts</p>	Informational

<p>rebinding</p> <p>Log Message: The IPv6 address < ipv6address > on interface <ipif-name> starts rebinding.</p> <p>Parameters description:</p> <p> ipv6address: ipv6 address obtained from a DHCPv6 server.</p> <p> ipif-name: Name of the DHCPv6 client interface.</p>	
<p>Event description: The ipv6 address obtained from a DHCPv6 server rebinds success</p> <p>Log Message: The IPv6 address < ipv6address > on interface <ipif-name> rebinds success.</p> <p>Parameters description:</p> <p> ipv6address: ipv6 address obtained from a DHCPv6 server.</p> <p> ipif-name: Name of the DHCPv6 client interface.</p>	Informational
<p>Event description: The ipv6 address from a DHCPv6 server was deleted.</p> <p>Log Message: The IPv6 address < ipv6address > on interface <ipif-name> was deleted.</p> <p>Parameters description:</p> <p> ipv6address: ipv6 address obtained from a DHCPv6 server.</p> <p> ipif-name: Name of the DHCPv6 client interface.</p>	Informational
<p>Event description: DHCPv6 client PD interface administrator state changed.</p> <p>Log Message: DHCPv6 client PD on interface <intf-name> changed state to <enabled disabled></p> <p>Parameters description:</p> <p> intf-name: Name of the DHCPv6 client PD interface.</p>	Informational
<p>Event description: DHCPv6 client PD obtains an IPv6 prefix from a delegation router.</p> <p>Log Message: DHCPv6 client PD obtains an ipv6 prefix < ipv6networkaddr> on interface <intf-name></p> <p>Parameters description:</p> <p> ipv6networkaddr: ipv6 preifx obtained from a delegation router.</p> <p> intf-name: Name of the DHCPv6 client PD interface.</p>	Informational
<p>Event description: The IPv6 prefix obtained from a delegation router starts renewing.</p> <p>Log Message: The IPv6 prefix < ipv6networkaddr > on interface <intf-name> starts renewing.</p> <p>Parameters description:</p> <p> ipv6networkaddr: IPv6 prefix obtained from a delegation router.</p> <p> intf-name: Name of the DHCPv6 client PD interface.</p>	Informational
<p>Event description: The IPv6 prefix obtained from a delegation router renews success.</p> <p>Log Message: The IPv6 prefix < ipv6networkaddr > on interface <intf-name> renews success.</p> <p>Parameters description:</p> <p> ipv6anetworkaddr: IPv6 prefix obtained from a delegation router.</p> <p> intf-name: Name of the DHCPv6 client PD nterface.</p>	Informational
<p>Event description: The IPv6 prefix obtained from a delegation router starts rebinding.</p> <p>Log Message: The IPv6 prefix < ipv6networkaddr > on interface <intf-name> starts rebinding.</p>	Informational

Parameters description:

ipv6address: IPv6 prefix obtained from a delegation router.

intf-name: Name of the DHCPv6 client PD interface.

Event description: The IPv6 prefix obtained from a delegation router rebinds success. Informational

Log Message: The IPv6 prefix < ipv6networkaddr > on interface <intf-name> rebinds success.

Parameters description:

ipv6address: IPv6 prefix obtained from a delegation router.

intf-name: Name of the DHCPv6 client PD interface.

Event description: The IPv6 prefix from a delegation router was deleted. Informational

Log Message: The IPv6 prefix < ipv6networkaddr > on interface <intf-name> was deleted.

Parameters description:

ipv6address: IPv6 prefix obtained from a delegation router.

intf-name: Name of the DHCPv6 client PD interface.

DHCPv6 Relay**Log Description****Severity**

Event description: DHCPv6 relay on a specify interface's administrator state changed Informational

Log Message: DHCPv6 relay on interface <ipif-name> changed state to [enabled | disabled]

Parameters description:

<ipif-name>: Name of the DHCPv6 relay agent interface.

DNS Resolver**Log Description****Severity**

Event description: Duplicate Domain name cache added, leads a dynamic domain name cache be deleted Informational

Log Message: [DNS_RESOLVER(1):]Duplicate Domain name case name: <domainname>, static IP: <ipaddr>, dynamic IP:<ipaddr>

Parameters description:

domainname: the domain name string.

ipaddr: IP address.

DOS Prevention**Log Description****Severity**

Event description: Detect DOS attack. Notice

Log Message: <dos-type> is dropped from (IP: <ip-address> Port <interface-id>).

Parameters description:

dos-type: DOS attack type

ip-address: IP address.

 interface-id: Interface name

Interface

Log Description	Severity
Event description: When port is down Log Message: Port <port-type>< interface-id> link down Parameters description: port-type: port type interface-id: Interface name	Informational
Event description: When port is up Log Message: Port <port-type>< interface-id> link up, <link-speed> Parameters description: port-type: port type interface-id: Interface name link-speed: port link speed.	Informational

JWAC

Log Description	Severity
Event description: when a host has passed the authentication. Log Message: JWAC host login success (Username: <string>, IP: <ipaddr ipv6address>, MAC: <mac-address>, <interface-id>, VID: <vlan-id>). Parameters description: Username: The host username. IP: The host IP address mac-address: The host MAC addresses. interface-id: The interface on which the host is authenticated. vlan-id: The VLAN ID on which the host exists	Informational
Event description: When a host fail to pass the authentication. Log Message: JWAC host login fail (Username: <string>, IP: <ipaddr ipv6address>, MAC: <mac-address>, <interface-id>, VID: <vlan-id>) Parameters description: Username: The host username. IP: The host IP address mac-address: The host MAC addresses.. interface-id: The interface on which the host is authenticated. vlan-id: The VLAN ID on which the host exists	Critical
Event description: when the authorized user number on the whole device has reached the maximum user limit. Log Message: JWAC enters stop learning state.	Warning
Event description: when the authorized user number on the whole device is below the maximum user limit in a time interval. Log Message: JWAC recovers from stop learning state.	Warning
Event description: When the ACL hardware resource is exhausted. Log Message: JWAC cannot work correctly because ACL rule resource is not	Alert

available.

LACP

Log Description	Severity
Event description: Link Aggregation Group link up. Log Message: Link Aggregation Group < group_id > link up. Parameters description: group_id: The group id of the link down aggregation group.	Informational
Event description: Link Aggregation Group link down. Log Message: Link Aggregation Group < group_id > link down. Parameters description: group_id: The group id of the link down aggregation group.	Informational
Event description: Member port attach to Link Aggregation Group. Log Message: <ifname> attach to Link Aggregation Group <group_id>. Parameters description: ifname: The interface name of the port that attach to aggregation group. group_id: The group id of the aggregation group that port attach to.	Informational
Event description: Member port detach from Link Aggregation Group. Log Message: <ifname> detach from Link Aggregation Group <group_id>. Parameters description: ifname: The interface name of the port that detach from aggregation group. group_id: The group id of the aggregation group that port detach from.	Informational

LBD

Log Description	Severity
Event description: Record the event when an interface detect loop. Log Message: <interface-id> LBD loop occurred. Parameters description: interface-id: Interface on which loop is detected.	Critical
Event description: Record the event when an interface detect loop. Log Message: <interface-id > VLAN <vlan-id> LBD loop occurred. Parameters description: interface-id: Interface on which loop is detected. vlan-id: VLAN on which loop is detected.	Critical
Event description: Record the event when an interface loop recovered Log Message: <interface-id> LBD loop recovered. Parameters description: interface-id: Interface on which loop is detected.	Critical
Event description: Record the event when an interface loop recovered. Log Message: <interface-id> VLAN <vlan-id> LBD loop recovered. Parameters description: interface-id: Interface on which loop is detected. vlan-id: VLAN on which loop is detected.	Critical

Event description: Record the event when the number of VLANs that loop back has occurred exceeds a reserved number.	Critical
Log Message: Loop VLAN numbers overflow.	
Event description: When the ACL hardware resource is exhausted.	Alert
Log Message: Web-Authentication cannot work correctly because ACL rule resource is not available.	

LLDP-MED

Log Description	Severity
<p>Event description: LLDP-MED topology change detected</p> <p>Log Message: LLDP-MED topology change detected (on port <portNum>. chassis id: <chassisType>, <chassisID>, port id: <portType>, <portID>, device class: <deviceClass>)</p> <p>Parameters description:</p> <p>portNum: The port number.</p> <p>chassisType: chassis ID subtype.</p> <p>Value list:</p> <ol style="list-style-type: none"> 1. chassisComponent(1) 2. interfaceAlias(2) 3. portComponent(3) 4. macAddress(4) 5. networkAddress(5) 6. interfaceName(6) 7. local(7) <p>chassisID: chassis ID.</p> <p>portType: port ID subtype.</p> <p>Value list:</p> <ol style="list-style-type: none"> 1. interfaceAlias(1) 2. portComponent(2) 3. macAddress(3) 4. networkAddress(4) 5. interfaceName(5) 6. agentCircuitId(6) 7. local(7) <p>portID: port ID.</p> <p>deviceClass: LLDP-MED device type.</p>	Notice
<p>Event description: Conflict LLDP-MED device type detected</p> <p>Log Message: Conflict LLDP-MED device type detected (on port < portNum >, chassis id: < chassisType>, <chassisID>, port id: < portType>, <portID>, device class: <deviceClass>)</p> <p>Parameters description:</p> <p>portNum: The port number.</p> <p>chassisType: chassis ID subtype.</p> <p>Value list:</p> <ol style="list-style-type: none"> 1. chassisComponent(1) 2. interfaceAlias(2) 3. portComponent(3) 	Notice

-
-
- 4. macAddress(4)
 - 5. networkAddress(5)
 - 6. interfaceName(6)
 - 7. local(7)
- chassisID: chassis ID.
portType: port ID subtype.
Value list:
- 1. interfaceAlias(1)
 - 2. portComponent(2)
 - 3. macAddress(3)
 - 4. networkAddress(4)
 - 5. interfaceName(5)
 - 6. agentCircuitId(6)
 - 7. local(7)
- portID: port ID.
deviceClass: LLDP-MED device type.
-

Event description: Incompatible LLDP-MED TLV set detected Notice

Log Message: Incompatible LLDP-MED TLV set detected (on port < portNum >, chassis id: < chassisType>, <chassisID>, port id: < portType>, <portID>, device class: <deviceClass>)

Parameters description:

- portNum: The port number.
chassisType: chassis ID subtype.
Value list:
- 1. chassisComponent(1)
 - 2. interfaceAlias(2)
 - 3. portComponent(3)
 - 4. macAddress(4)
 - 5. networkAddress(5)
 - 6. interfaceName(6)
 - 7. local(7)
- chassisID: chassis ID.
portType: port ID subtype.
Value list:
- 1. interfaceAlias(1)
 - 2. portComponent(2)
 - 3. macAddress(3)
 - 4. networkAddress(4)
 - 5. interfaceName(5)
 - 6. agentCircuitId(6)
 - 7. local(7)
- portID: port ID.
deviceClass: LLDP-MED device type.
-

Login/Logout CLI

Log Description	Severity
-----------------	----------

<p>Event description: Login through console successfully.</p> <p>Log Message: [Unit <unitID>,]Successful login through Console (Username: <username>)</p> <p>Parameters description: unitID: The unit ID. username: Represent current login user.</p>	Informational
<p>Event description: Login through console unsuccessfully.</p> <p>Log Message: [Unit <unitID>,] Login failed through Console (Username: <username>)</p> <p>Parameters description: unitID: The unit ID. username: Represent current login user.</p>	Warning
<p>Event description: Console session timed out.</p> <p>Log Message: [Unit <unitID>,] Console session timed out (Username: <username>)</p> <p>Parameters description: unitID: The unit ID. username: Represent current login user.</p>	Informational
<p>Event description: Logout through console.</p> <p>Log Message: [Unit <unitID>,] Logout through Console (Username: <username>)</p> <p>Parameters description: unitID: The unit ID. username: Represent current login user.</p>	Informational
<p>Event description: Login through telnet successfully.</p> <p>Log Message: Successful login through Telnet (Username: <username>, IP: <ipaddr>)</p> <p>Parameters description: username: Represent current login user. ipaddr: Represent client IP address.</p>	Informational
<p>Event description: Login through telnet unsuccessfully.</p> <p>Log Message: Login failed through Telnet (Username: <username>, IP: <ipaddr>)</p> <p>Parameters description: username: Represent current login user. ipaddr: Represent client IP address.</p>	Warning
<p>Event description: Telnet session timed out.</p> <p>Log Message: Telnet session timed out (Username: <username>, IP: <ipaddr>)</p> <p>Parameters description: username: Represent current login user. ipaddr: Represent client IP address.</p>	Informational
<p>Event description: Logout through telnet.</p> <p>Log Message: Logout through Telnet (Username: <username>, IP: <ipaddr>)</p> <p>Parameters description: username: Represent current login user. ipaddr: Represent client IP address.</p>	Informational
<p>Event description: Login through SSH successfully.</p> <p>Log Message: Successful login through SSH (Username: <username>, IP: <ipaddr>)</p>	Informational

Parameters description: username: Represent current login user. ipaddr: Represent client IP address.	
Event description: Login through SSH unsuccessfully. Log Message: Login failed through SSH (Username: <username>, IP: <ipaddr>) Parameters description: username: Represent current login user. ipaddr: Represent client IP address.	Critical
Event description: SSH session timed out. Log Message: SSH session timed out (Username: <username>, IP: <ipaddr>) Parameters description: username: Represent current login user. ipaddr: Represent client IP address.	Informational
Event description: Logout through SSH. Log Message: Logout through SSH (Username: <username>, IP: <ipaddr>) Parameters description: username: Represent current login user. ipaddr: Represent client IP address.	Informational

MAC-based Access Control

Log Description	Severity
Event description: A host has passed the authentication. Log Message: MAC-based Access Control host login success (MAC: <mac-address>, <interface-id>, VID: <vlan-id>). Parameters description: mac-address: The host MAC address interface-id: The interface on which the host is authenticated vlan-id: The VLAN ID on which the host exists	Informational
Event description: A host has aged out. Log Message: MAC-based Access Control host aged out (MAC: <mac-address>, <interface-id>, VID: <vlan-id>). Parameters description: mac-address: The host MAC address interface-id: The interface on which the host is authenticated vlan-id: The VLAN ID on which the host exists	Informational
Event description: A host failed to pass the authentication. Log Message: MAC-based Access Control host login fail (MAC: <mac-address>, <interface-id>, VID: <vlan-id>). Parameters description: mac-address: The host MAC address interface-id: The interface on which the host is authenticated vlan-id: The VLAN ID on which the host exists	Critical
Event description: The authorized user number on the whole device has reached the maximum user limit. Log Message: MAC-based Access Control enters stop learning state.	Warning

<p>Event description: The authorized user number on the whole device is below the maximum user limit in a time interval.</p> <p>Log Message: MAC-based Access Control recovers from stop learning state.</p>	Warning
<p>Event description: The authorized user number on an interface has reached the maximum user limit.</p> <p>Log Message: <interface-id> enters MAC-based Access Control stop learning state.</p> <p>Parameters description: interface-id: The interface on which the host is authenticated</p>	Warning
<p>Event description: The authorized user number on a interface is below the maximum user limit in a time interval.</p> <p>Log Message: <interface-id> recovers from MAC-based Access Control stop learning state.</p> <p>Parameters description: interface-id: The interface on which the host is authenticated</p>	Warning

MSTP Debug Enhancement

Log Description	Severity
<p>Event description: Used to record the event that Spanning Tree Protocol is enabled.</p> <p>Log Message: Spanning Tree Protocol is enabled</p>	Informational
<p>Event description: Used to record the event that Spanning Tree Protocol is disabled</p> <p>Log Message: Spanning Tree Protocol is disabled.</p>	Informational
<p>Event description: Used to record MSTP instance topology change event.</p> <p>Log Message: Topology changed (Instance : < Instance-id >,<interface_id>, MAC:<macaddr>)</p> <p>Parameters description: Instance-id: MST instance id. Instance 0 represents for default instance, CIST. interface_id: The port number which detect or reive topochange information. macaddr: The system of bridge mac address.</p>	Notice
<p>Event description: Used to record MSTP instance new root bridge selected.</p> <p>Log Message: [CIST CIST Regional MSTI Regional] New Root bridge selected ([Instance: <Instance-id>] MAC: <macaddr> Priority :< priority>)</p> <p>Parameters description: Instance-id: MST instance id. Instance 0 represents for default instance, CIST. macaddr: The system of bridge mac address. priority: The bridge priority value must be divisible by 4096</p>	Informational
<p>Event description: Used to record MSTP instance new root port selected.</p> <p>Log Message: New root port selected (Instance:<Instance-id >, <interface_id >)</p> <p>Parameters description: Instance-id: MST instance id. Instance 0 represents for default instance, CIST. interface_id: The port number which detect or rereive topochange</p>	Notice

information.	
<p>Event description: Used to record MSTP instance port state change event.</p> <p>Log Message: Spanning Tree port status change (Instance :< Instance-id >, <interface_id>) <old_status> -> <new_status></p> <p>Parameters description:</p> <p>Instance-id: MST instance id. Instance 0 represents for default instance, CIST.</p> <p>interface_id: The port number which detect or receive topochange information.</p> <p>old status:</p> <p>new status:</p> <p>The port of STP state. The value may be Disable, Discarding, Learning, Forwarding</p>	Notice
<p>Event description: Used to record MSTP instance port role change event.</p> <p>Log Message: Spanning Tree port role change (Instance :< Instance-id >, <interface_id>) <old_role> -> <new_role></p> <p>Parameters description:</p> <p>Instance-id: MST instance id. Instance 0 represents for default instance, CIST.</p> <p>Interface_id: The port number which detect or receive topochange information.</p> <p>old role:</p> <p>new role :</p> <p>The port role of stp. The value may be Disable, Alternate, Backup, Root, Designated</p>	Informational
<p>Event description: Use to record action to create an MST instance.</p> <p>Log Message: Spanning Tree instance created (Instance :< Instance-id >)</p> <p>Parameters description:</p> <p>Instance-id: MST instance id. Instance 0 represents for default instance, CIST.</p>	Informational
<p>Event description: Use to record action to delete an MST instance.</p> <p>Log Message: Spanning Tree instance deleted (Instance :< Instance-id >)</p> <p>Parameters description:</p> <p>Instance-id: MST instance id. Instance 0 represents for default instance, CIST.</p>	Informational
<p>Event description: Use to record action to change the STP version.</p> <p>Log Message: Spanning Tree version change (new version :< new_version>)</p> <p>Parameters description:</p> <p>new_version: Running under which version of STP.</p>	Informational
<p>Event description: Spanning Tree MST configuration ID name and revision level change (name :< name>, revision level <revision_level>).</p> <p>Log Message: Used to record the configuration name and revision level changed in the MST Configuration Identification.</p> <p>Parameters description:</p> <p>name: The name given for a specified MST region.</p> <p>revision_level: Switches using the same given name but with a different revision level are considered members of different MST regions.</p>	Informational
<p>Event description: Use to record action to maps a VLAN(s) to an MST instance.</p> <p>Log Message: Spanning Tree MST configuration ID VLAN mapping table change</p>	Informational

(instance: <Instance-id> add vlan <startvlanid> [- <endvlanid>])

Parameters description:

Instance-id: MST instance id. Instance 0 represents for default instance, CIST.

startvlanid: The start vid of add vlan range.

endvlanid: The end vid of add vlan range.

Event description: Use to record action to delete a VLAN(s) from an MST instance. Informational

Log Message: Spanning Tree MST configuration ID VLAN mapping table change (instance: <Instance-id> delete vlan <startvlanid> [- <endvlanid>])

Parameters description:

Instance-id: MST instance id. Instance 0 represents for default instance, CIST.

startvlanid: The start vid of add vlan range.

endvlanid: The end vid of add vlan range.

Event description: Used to record the event that port role change to alternate due to guard root.

Log Message: Spanning Tree port role change (Instance :< instance-id >, <interface-id>) to alternate port due to the guard root

Parameters description:

Instance-id: MST instance id. Instance 0 represents for default instance, CIST.

Interface_id: The port number which detect the event.

Peripheral

Log Description	Severity
Event description: Fan Recovered. Log Message: Unit <id>, <fan-descr> back to normal. Parameters description: Unit <id>: The unit ID. fan-descr: The FAN ID and position.	Critical
Event description: Fan Fail Log Message: Unit <id> <fan-descr> failed Parameters description: Unit <id>: The unit ID. fan-descr: The FAN ID and position.	Critical
Event description: Temperature sensor enters alarm state. Log Message: Unit <unit-id> <thermal-sensor-descr> detects abnormal temperature <degree> Parameters description: unitID: The unit ID. thermal-sensor-descr: The sensor ID and position. degree: The current temperature.	Critical
Event description: Temperature recovers to normal. Log Message: Unit <unit-id> <thermal-sensor-descr> temperature back to normal Parameters description: unitID: The unit ID.	Critical

thermal-sensor-descr: The sensor ID and position.	
Event description: Power failed.	Critical
Log Message: Unit <unit-id> <power-descr> failed	
Parameters description:	
unitID: The unit ID.	
power-descr: The power position and ID.	
Event description: Power is recovered.	Critical
Log Message: Unit <unit-id> <power-descr> back to normal	
Parameters description:	
unitID: The unit ID.	
power-descr: The power position and ID.	
Event description: Press the factory reset button.	Critical
Log Message: Unit <unit-id> factory reset button pressed.	
Parameters description:	
unitID: The unit ID.	

PoE

Log Description	Severity
Event description: Total power usage threshold is exceeded	Warning
Log Message: Unit <unit-id> usage threshold <percentage> is exceeded	
Parameters description:	
unit-id : box id	
percentage : usage threshold	
Event description: Total power usage threshold is recovered.	Warning
Log Message: Unit <unit-id> usage threshold <percentage> is recovered	
Parameters description:	
unit-id : box id	
percentage : usage threshold	

Port Security

Log Description	Severity
Event description: Address full on a port	Warning
Log Message: MAC address <macaddr> causes port security violation on <interface-id>.	
Parameters description:	
macaddr: The violation MAC address.	
interface-id: The interface name.	
Event description: Address full on system	Warning
Log Message: Limit on system entry number has been exceeded.	

Safeguard

Log Description	Severity
-----------------	----------

Event description: the host enters the mode of exhausted.	Warning
Log Message: Unit <unit-id>, Safeguard Engine enters EXHAUSTED mode.	
Parameters description: unit-id: The Unit ID	
Event description: the host enters the mode of normal.	Informational
Log Message: Unit <unit-id>, Safeguard Engine enters NORMAL mode.	
Parameters description: unit-id: The Unit ID	

SNMP

Log Description	Severity
Event Description: SNMP request received with invalid community string	Informational
Log Message: SNMP request received from <ipaddr> with invalid community string.	
Parameters Description: ipaddr: The IP address.	

SSH

Log Description	Severity
Event description: SSH server is enabled.	Informational
Log Message: SSH server is enabled	
Event description: SSH server is disabled.	Informational
Log Message: SSH server is disabled	
Event description: Login failed through SSH.	Critical
Log Message: Login failed through SSH (Username: <username>, IP: <ipaddr ipv6address>).	
Parameters description: username: User name which logs in fail. ipaddr: IP address of host from which the user logged in. ipv6address: IPv6 address of host from which the user logged in.	

Stacking

Log Description	Severity
Event description: Hot insertion.	Informational
Log Message: Unit: <unitID>, MAC: <macaddr> Hot insertion.	
Parameters description: unitID: Box ID. Macaddr: MAC address.	
Event description: Hot removal.	Informational
Log Message: Unit: <unitID>, MAC: <macaddr> Hot removal.	
Parameters description: unitID: Box ID.	

Macaddr: MAC address.	
Event description: Stacking topology change.	Informational
Log Message: Stacking topology is <Stack_TP_TYPE>. Master(Unit <unitID>, MAC:<macaddr>).	
Parameters description:	
Stack_TP_TYPE: The stacking topology type is one of the following:	
1. Ring,	
2. Chain.	
unitID: Box ID.	
Macaddr: MAC address.	
Event description: Backup master changed to master.	Informational
Log Message: Backup master changed to master. Master (Unit: <unitID>).	
Parameters description:	
unitID: Box ID.	
Event description: Slave changed to master	Informational
Log Message: Slave changed to master. Master (Unit: <unitID>).	
Parameters description:	
unitID: Box ID.	
Event description: Box ID conflict.	Critical
Log Message: Hot insert failed, box ID conflict: Unit <unitID> conflict (MAC: <macaddr> and MAC: <macaddr>).	
Parameters description:	
unitID: Box ID.	
macaddr: The MAC addresses of the conflicting boxes.	

Storm Control

Log Description	Severity
Event description: Storm occurrence.	Warning
Log Message: <Broadcast Multicast Unicast> storm is occurring on <interface-id>.	
Parameters description:	
Broadcast: Storm is resulted by broadcast packets(DA = FF:FF:FF:FF:FF:FF).	
Multicast: Storm is resulted by multicast packets, including unknown L2 multicast, known L2 multicast, unknown IP multicast and known IP multicast.	
Unicast: Storm is resulted by unicast packets, including both known and unknown unicast packets	
interface-id: The interface ID on which a storm is occurring.	
Event description: Storm cleared.	Informational
Log Message: <Broadcast Multicast Unicast> storm is cleared on <interface-id>.	
Parameters description:	
Broadcast: Broadcast storm is cleared.	
Multicast: Multicast storm is cleared.	
Unicast: Unicast storm (including both known and unknown unicast packets) is cleared.	

interface-id: The interface ID on which a storm is cleared.	
Event description: Port shut down due to a packet storm	Warning
Log Message: <interface-id> is currently shut down due to the <Broadcast Multicast Unicast> storm.	
Parameters description:	
interface-id: The interface ID on which is error-disabled by storm.	
Broadcast: The interface is disabled by broadcast storm.	
Multicast: The interface is disabled by multicast storm.	
Unicast: The interface is disabled by unicast storm (including both known and unknown unicast packets).	

Voice-VLAN

Log Description	Severity
Event description: When a new voice device is detected on an interface. Log Message: New voice device detected (<interface-id>, MAC: < mac-address >) Parameters description: interface-id: Interface name. mac-address: Voice device MAC address	Informational
Event description: When an interface which is in auto voice VLAN mode joins the voice VLAN Log Message: < interface-id > add into voice VLAN <vid > Parameters description: interface-id: Interface name. vid:VLAN ID	Informational
Event description: When an interface leaves the voice VLAN and at the same time, no voice device is detected in the aging interval for that interface, the log message will be sent. Log Message: < interface-id > remove from voice VLAN <vid > Parameters description: interface-id: Interface name. vid:VLAN ID	Informational

Web

Log Description	Severity
Event description: Successful login through Web. Log Message: Successful login through Web (Username: <username>, IP: <ipaddr>). Parameters description: username: The use name that used to login HTTP server. ipaddr: The IP address of HTTP client.	Informational
Event description: Login failed through Web. Log Message: Login failed through Web (Username: <username>, IP: <ipaddr>). Parameters description: username: The use name that used to login HTTP server. ipaddr: The IP address of HTTP client.	Warning

Event description: Web session timed out.	Informational
Log Message: Web session timed out (Username: <username>, IP: <ipaddr>).	
Parameters description: username: The use name that used to login HTTP server. ipaddr: The IP address of HTTP client.	
Event description: Logout through Web.	Informational
Log Message: Logout through Web (Username: %S, IP: %S).	
Parameters description: username: The use name that used to login HTTP server. ipaddr: The IP address of HTTP client.	

Web-Authentication

Log Description	Severity
Event description: When a host has passed the authentication.	Informational
Log Message: Web-Authentication host login success (Username: <string>, IP: <ipaddr ipv6address>, MAC: <mac-address>, <interface-id>, VID: <vlan-id>)	
Parameters description: Username: The host username. IP: The host IP address mac-address: The host MAC addresses. interface-id: The interface on which the host is authenticated. vlan-id: The VLAN ID on which the host exists	
Event description: When a host fail to pass the authentication.	Critical
Log Message: Web-Authentication host login fail (Username: <string>, IP: <ipaddr ipv6address>, MAC: <mac-address>, <interface-id>, VID: <vlan-id>).	
Parameters description: Username: The host username. IP: The host IP address mac-address: The host MAC addresses.. interface-id: The interface on which the host is authenticated. vlan-id: The VLAN ID on which the host exists	
Event description: when the authorized user number on the whole device has reached the maximum user limit.	Warning
Log Message: Web-Authentication enters stop learning state.	
Event description: when the authorized user number on the whole device is below the maximum user limit in a time interval.	Warning
Log Message: Web-Authentication recovers from stop learning state.	

Appendix B - Trap Entries

The following table lists all possible trap log entries and their corresponding meanings that will appear in the switch.

802.1X

Trap Name	Description	OID
dDot1xExtLoggedSuccess	The trap is sent when a host has successfully logged in (passed 802.1X authentication). Binding objects: (1) ifIndex (2) dnaSessionClientMacAddress (3) dnaSessionAuthVlan (4) dnaSessionAuthUserName	1.3.6.1.4.1.17 1.14.30.0.1
dDot1xExtLoggedFail	The trap is sent when a host failed to pass 802.1X authentication (login failed). Binding objects: (1) ifIndex (2) dnaSessionClientMacAddress (3) dnaSessionAuthVlan (4) dnaSessionAuthUserName (5) dDot1xExtNotifyFailReason	1.3.6.1.4.1.17 1.14.30.0.2

Authentication Fail

Trap Name	Description	OID
authenticationFailure	An authenticationFailure trap signifies that the SNMPv2 entity, acting in an agent role, has received a protocol message that is not properly authenticated. While all implementations of the SNMPv2 must be capable of generating this trap, the snmpEnableAuthenTraps object indicates whether this trap will be generated.	1.3.6.1.6.3.1. 1.5.5

BPDU Attack Protection

Trap Name	Description	OID
dBpduProtectionAttackOccur	This trap is sent when the BPDU attack happened on an interface. Binding objects: (1) ifIndex (2) dBpduProtectionIfCfgMode	1.3.6.1.4.1.17 1.14.47.0.1
dBpduProtectionAttackRecover	This trap is sent when the BPDU attack recovered on an interface. Binding objects: (1) ifIndex	1.3.6.1.4.1.17 1.14.47.0.2

DDM

Trap Name	Description	OID
dDdmAlarmTrap	A notification is generated when an abnormal alarm situation occurs, or recovers from an abnormal alarm situation to normal status. Binding objects: (1) dDdmNotifyInfoIndex (2) dDdmNotifyInfoComponent (3) dDdmNotifyInfoAbnormalLevel (4) dDdmNotifyInfoThresholdExceedOrRecover	1.3.6.1.4.1.17 1.14.72.0.1
dDdmWarningTrap	A notification is generated when an abnormal warning situation occurs, or recovers from an abnormal warning situation to normal status. Binding objects: (1) dDdmNotifyInfoIndex, (2) dDdmNotifyInfoComponent (3) dDdmNotifyInfoAbnormalLevel (4) dDdmNotifyInfoThresholdExceedOrRecover	1.3.6.1.4.1.17 1.14.72.0.2

DHCP Server Screen Prevention

Trap Name	Description	OID
dDhcpFilterAttackDetected	When DHCP Server Screen is enabled, if the switch received the forge DHCP Server packet, the switch will trap the event if any attacking packet is received. Binding objects: (1) dDhcpFilterLogBufServerIpAddr (2) dDhcpFilterLogBufClientMacAddr (3) dDhcpFilterLogBufferVlanId (4) dDhcpFilterLogBufferOccurTime	1.3.6.1.4.1.17 1.14.133.0.1

DOS Prevention

Trap Name	Description	OID
dDosPreveAttackDetectedPacket	The trap is sent when detect DOS attack. Binding objects: (1) dDoSPrevCtrlAttackType (2) dDosPrevNotiInfoDropIpAddr (3) dDosPrevNotiInfoDropPortNumber	1.3.6.1.4.1.17 1.14.59.0.2

ErrDisable

Trap Name	Description	OID
dErrDisNotifyPortDisabledAssert	The trap is sent when a port enters into error disabled state.	1.3.6.1.4.1.17 1.14.45.0.1

	Binding objects: (1) dErrDisNotifyInfoPortIfIndex (2) dErrDisNotifyInfoReasonID	
dErrDisNotifyPortDisabledClear	The trap is sent when a port loop restarts after the interval time. Binding objects: (1) dErrDisNotifyInfoPortIfIndex (2) dErrDisNotifyInfoReasonID	1.3.6.1.4.1.17 1.14.45.0.2

General Management

Trap Name	Description	OID
dGenMgmtLoginFail	This trap is sent when the user login failed to the switch. Binding objects: (1) dGenMgmtNotifyInfoLoginType (2) dGenMgmtNotifyInfoUserName	1.3.6.1.4.1.17 1.14.165.0.1

Gratuitous ARP Function

Trap Name	Description	OID
agentGratuitousARPTrap	The trap is sent when IP address conflicted. Binding objects: (1) ipaddr (2) macaddr (3) portNumber (4) agentGratuitousARPInterfaceName	1.3.6.1.4.1.17 1.14.75.0.1

IMPB

Trap Name	Description	OID
dImpbViolationTrap	The address violation notification is generated when IP-MAC-Port Bindingaddress violation is detected. Binding objects: (1) ifIndex (2) dImpbViolationIpAddrType (3) dImpbViolationIpAddress (4) dImpbViolationMacAddress	1.3.6.1.4.1.17 1.14.22.0.1

LACP

Trap Name	Description	OID
linkUp	A linkUp trap signifies that the SNMP entity, acting in an agent role, has detected that the ifOperStatus object for one of its communication links left the down state and transitioned into some other state	1.3.6.1.6.3.1. 1.5.4

	(but not into the notPresent state). This other state is indicated by the included value of ifOperStatus. Binding objects: (1) ifIndex, (2) if AdminStatus (3) ifOperStatu	
linkDown	A linkDown trap signifies that the SNMP entity, acting in an agent role, has detected that the ifOperStatus object for one of its communication links is about to enter the down state from some other state (but not from the notPresent state). This other state is indicated by the included value of ifOperStatus. Binding objects: (1) ifIndex, (2) if AdminStatus (3) ifOperStatu	1.3.6.1.6.3.1.1.5.3

LBD

Trap Name	Description	OID
dLbdLoopOccurred	This trap is sent when an interface loop occurs. Binding objects: (1) dLbdNotifyInfolIndex	1.3.6.1.4.1.17 1.14.46.0.1
dLbdLoopRestart	This trap is sent when an interface loop restarts after the interval time. Binding objects: (1) dLbdNotifyInfolIndex	1.3.6.1.4.1.17 1.14.46.0.2
dLbdVlanLoopOccurred	This trap is sent when an interface with a VID loop occurs. Binding objects: (1) dLbdNotifyInfolIndex (2) dLbdNotifyInfoVlanId	1.3.6.1.4.1.17 1.14.46.0.3
dLbdVlanLoopRestart	This trap is sent when an interface loop with a VID restarts after the interval time. Binding objects: (1) dLbdNotifyInfolIndex (2) dLbdNotifyInfoVlanId	1.3.6.1.4.1.17 1.14.46.0.4

LLDP

Trap Name	Description	OID
lldpRemTablesChange	A lldpRemTablesChange notification is sent when the value of lldpStatsRemTableLastChangeTime changes. It can be utilized by an NMS to trigger LLDP remote systems table maintenance polls. Binding objects: (1) lldpStatsRemTablesInserts (2) lldpStatsRemTablesDeletes	1.0.8802.1.1.2.0.0.1

	(3) IldpStatsRemTablesDrops (4) IldpStatsRemTablesAgeouts	
IldpXMedTopologyChangeDetected	A notification generated by the local device sensing a change in the topology that indicates that a new remote device attached to a local port, or a remote device disconnected or moved from one port to another. Binding objects: (1) IldpRemChassisIdSubtype (2) IldpRemChassisId (3) IldpXMedRemDeviceClass	1.0.8802.1.1.2.1.5.4795.0.1

MAC-based Access Control

Trap Name	Description	OID
dMacAuthLoggedSuccess	The trap is sent when a MAC-based Access Control host is successfully logged in. Binding objects: (1) ifIndex, (2) dnaSessionClientMacAddress (3) dnaSessionAuthVlan	1.3.6.1.4.1.17.1.14.153.0.1
dMacAuthLoggedFail	The trap is sent when a MAC-based Access Control host login fails. Binding objects: (1) ifIndex, (2) dnaSessionClientMacAddress (3) dnaSessionAuthVlan	1.3.6.1.4.1.17.1.14.153.0.2
dMacAuthLoggedAgesOut	The trap is sent when a MAC-based Access Control host ages out. Binding objects: (1) ifIndex, (2) dnaSessionClientMacAddress (3) dnaSessionAuthVlan	1.3.6.1.4.1.17.1.14.153.0.3

MAC-notification

Trap Name	Description	OID
dL2FdbMacNotificatio	This trap indicate the MAC addresses variation in the address table. Binding objects: (1) dL2FdbMacChangeNotifyInfo	1.3.6.1.4.1.17.1.14.3.0.1

MSTP

Trap Name	Description	OID
newRoot	The newRoot trap indicates that the sending agent has become the new root of the Spanning Tree; the	1.3.6.1.2.1.17.0.1

	trap is sent by a bridge soon after its election as the new root, e.g., upon expiration of the Topology Change Timer, immediately subsequent to its election. Implementation of this trap is optional.	
topologyChange	A topologyChange trap is sent by a bridge when any of its configured ports transitions from the Learning state to the Forwarding state, or from the Forwarding state to the Blocking state. The trap is not sent if a newRoot trap is sent for the same transition. Implementation of this trap is optional	1.3.6.1.2.1.17 .0.2

Peripheral

Trap Name	Description	OID
dEntityExtPowerStatusChg	Power Status change notification. Binding objects: (1) dEntityExtEnvPowerUnitId (2) dEntityExtEnvPowerIndex (3) dEntityExtEnvPowerStatus	1.3.6.1.4.1.17 1.14.5.0.3
dEntityExtFanStatusChg	Fan status change notification. Binding objects: (1) dEntityExtEnvFanUnitId (2) dEntityExtEnvFanIndex (3) dEntityExtEnvFanStatus	1.3.6.1.4.1.17 1.14.5.0.1
dEntityExtThermalStatusChg	Temperature status change notification. Binding objects: (1) dEntityExtEnvTempUnitId (2) dEntityExtEnvTempIndex (3) dEntityExtEnvTempStatus	1.3.6.1.4.1.17 1.14.5.0.2
dEntityExtFactoryResetButton	Press factory reset button notification Binding objects: (1) dEntityExtUnitIndex	1.3.6.1.4.1.17 1.14.5.0.5

PoE

Trap Name	Description	OID
pethMainPowerUsageOnNotification	This trap indicates PSE Threshold usage indication is on, the usage power is above the threshold. At least 500 msec must elapse between notifications being emitted by the same object instance. Binding objects: (1) pethMainPseConsumptionPower	1.3.6.1.2.1.10 5.0.2
pethMainPowerUsageOffNotification	This trap indicates PSE Threshold usage indication is off, the usage power is below the threshold. At least 500 msec must elapse between notifications being emitted by the same object instance. Binding objects: (1) pethMainPseConsumptionPower	1.3.6.1.2.1.10 5.0.3

dPoelfPowerDeniedNotification	This Notification indicates if PSE state diagram enters the state POWER_DENIED. At least 500 msec must elapse between notifications being emitted by the same object instance. Binding objects: (1) pethPsePortPowerDeniedCounter	1.3.6.1.4.1.17 1.14.24.0.1
dPoelfPowerOverLoadNotification	This trap indicates if PSE state diagram enters the state ERROR_DELAY_OVER. At least 500 msec must elapse between notifications being emitted by the same object instance. Binding objects: (1) pethPsePortOverLoadCounter	1.3.6.1.4.1.17 1.14.24.0.2
dPoelfPowerShortCircuitNotification	This trap indicates if PSE state diagram enters the state ERROR_DELAY_SHORT. At least 500 msec must elapse between notifications being emitted by the same object instance. Binding objects: (1) pethPsePortShortCounter	1.3.6.1.4.1.17 1.14.24.0.3

Port

Trap Name	Description	OID
linkUp	A notification is generated when port linkup. Binding objects: (1) ifIndex (2) if AdminStatus (3) ifOperStatus	1.3.6.1.6.3.1. 1.5.4
linkDown	A notification is generated when port linkdown. Binding objects: (1) ifIndex (2) if AdminStatus (3) ifOperStatus	1.3.6.1.6.3.1. 1.5.3

Port Security

Trap Name	Description	OID
dPortSecMacAddrViolation	When the port security trap is enabled, new MAC addresses that violate the pre-defined port security configuration will trigger trap messages to be sent out. Binding objects: (1) ifIndex (2) dPortSecIfCurrentStatus (3) dPortSecIfViolationMacAddress	1.3.6.1.4.1.17 1.14.8.0.1

RMON

Trap Name	Description	OID
risingAlarm	The SNMP trap that is generated when an alarm entry crosses its rising threshold and generates an event that is configured for sending SNMP traps. Binding objects: (1)alarmIndex (2)alarmVariable (3)alarmSampleType (4) alarmValue (5) alarmRisingThreshold	1.3.6.1.2.1.16 .0.1
fallingAlarm	The SNMP trap that is generated when an alarm entry crosses its falling threshold and generates an event that is configured for sending SNMP traps. Binding objects: (1)alarmIndex (2) alarmVariable (3)alarmSampleType (4)alarmValue (5) alarmFallingThreshold	1.3.6.1.2.1.16 .0.2

Safeguard

Trap Name	Description	OID
dSafeguardChgToExhausted	This trap indicates System change operation mode from normal to exhaust. Binding objects: (1) dSafeguardEngineCurrentMode	1.3.6.1.4.1.17 1.14.19.1.1.0. 1
dSafeguardChgToNormal	This trap indicates system change operation mode from exhausted to normal. Binding objects: (1) dSafeguardEngineCurrentMode	1.3.6.1.4.1.17 1.14.19.1.1.0. 2

Stack

Trap Name	Description	OID
dStackInsertNotification	Unit Hot Insert notification. Binding objects: (1) dStackNotifyInfoBoxId (2) dStackInfoMacAddr	1.3.6.1.4.1.17 1.14.9.0.1
dStackRemoveNotification	Unit Hot Remove notification. Binding objects: (1) dStackNotifyInfoBoxId (2) dStackInfoMacAddr	1.3.6.1.4.1.17 1.14.9.0.2
dStackFailureNotification	Unit Failure notification. Binding objects: (1) dStackNotifyInfoBoxId	1.3.6.1.4.1.17 1.14.9.0.3

dStackTPChangeNotification	The stacking topology change notification. Binding objects: (1) dStackNotifyInfoTopologyType (2) dStackNotifyInfoBoxId (3) dStackInfoMacAddr	1.3.6.1.4.1.17 1.14.9.0.4
dStackRoleChangeNotification	The stacking unit role change notification. Binding objects: (1) dStackNotifyInfoRoleChangeType (2) dStackNotifyInfoBoxId	1.3.6.1.4.1.17 1.14.9.0.5

SIM

Trap Name	Description	OID
swSingleIPMSColdStart	The commander switch will send this notification when its member generates a cold start notification. Binding objects: (1) swSingleIPMSID (2) swSingleIPMSMacAddr	1.3.6.1.4.1.17 1.12.8.6.0.11
swSingleIPMSWarmStart	The commander switch will send this notification when its member generates a warm start notification. Binding objects: (1) swSingleIPMSID (2) swSingleIPMSMacAddr	1.3.6.1.4.1.17 1.12.8.6.0.12
swSingleIPMSLinkDown	The commander switch will send this notification when its member generates a link down notification. Binding objects: (1) swSingleIPMSID (2) swSingleIPMSMacAddr (3) ifIndex	1.3.6.1.4.1.17 1.12.8.6.0.13
swSingleIPMSLinkUp	The commander switch will send this notification when its member generates a link up notification. Binding objects: (1) swSingleIPMSID (2) swSingleIPMSMacAddr (3) ifIndex	1.3.6.1.4.1.17 1.12.8.6.0.14
swSingleIPMSAuthFail	The commander switch will send this notification when its member generates an authentication failure notification. Binding objects: (1) swSingleIPMSID (2) swSingleIPMSMacAddr	1.3.6.1.4.1.17 1.12.8.6.0.15
swSingleIPMSNewRoot	The commander switch will send this notification when its member generates a new root notification. Binding objects: (1) swSingleIPMSID (2) swSingleIPMSMacAddr	1.3.6.1.4.1.17 1.12.8.6.0.16
swSingleIPMSTopologyChange	The commander switch will send this notification	1.3.6.1.4.1.17

when its member generates a topology change notification.

Binding objects:

(1) swSingleIPMSID

(2) swSingleIPMSMacAddr

Start

Trap Name	Description	OID
coldStart	A coldStart trap signifies that the SNMPv2 entity, acting in an agent role, is reinitializing itself and that its configuration may have been altered.	1.3.6.1.6.3.1.1.5.1
warmStart	A warmStart trap signifies that the SNMPv2 entity, acting in an agent role, is reinitializing itself such that its configuration is unaltered.	1.3.6.1.6.3.1.1.5.2

Storm Control

Trap Name	Description	OID
dStormCtrlOccurred	This trap is sent when dStormCtrlNotifyEnable is 'stormOccurred' or 'both' and a storm is detected. Binding objects: (1) ifIndex, (2) dStormCtrlNotifyTrafficType	1.3.6.1.4.1.17.1.14.25.0.1
dStormCtrlStormCleared	This trap is sent when dStormCtrlNotifyEnable is 'stormCleared' or 'both' and a storm is cleared. Binding objects: (1) ifIndex, (2) dStormCtrlNotifyTrafficType	1.3.6.1.4.1.17.1.14.25.0.2

System File

Trap Name	Description	OID
dsfUploadImage	The notification is sent when the user uploads image file successfully.	1.3.6.1.4.1.17.1.14.14.0.1
dsfDownloadImage	The notification is sent when the user downloads image file successfully.	1.3.6.1.4.1.17.1.14.14.0.2
dsfUploadCfg	The notification is sent when the user uploads configuration file successfully.	1.3.6.1.4.1.17.1.14.14.0.3
dsfDownloadCfg	The notification is sent when the user downloads configuration file successfully.	1.3.6.1.4.1.17.1.14.14.0.4
dsfSaveCfg	The notification is sent when the user saves configuration file successfully.	1.3.6.1.4.1.17.1.14.14.0.5

Web-Authentication

Trap Name	Description	OID
dWebAuthLoggedSuccess	The trap is sent when a host has successfully logged in (passed Web-Authentication). Binding objects: (1) ifIndex (2) dnaSessionAuthVlan (3) dnaSessionClientMacAddress (4) dnaSessionClientAddrType (5) dnaSessionClientAddress (6) dnaSessionAuthUserName	1.3.6.1.4.1.17 1.14.154.0.1
dWebAuthLoggedFail	The trap is sent when a host has failed to pass Web-Authentication (login failed). Binding objects: (1) ifIndex (2) dnaSessionAuthVlan (3) dnaSessionClientMacAddress (4) dnaSessionClientAddrType (5) dnaSessionClientAddress (6) dnaSessionAuthUserName	1.3.6.1.4.1.17 1.14.154.0.2

Appendix C - RADIUS Attributes Assignment

The RADIUS Attributes Assignment on the DGS-1510 is used in the following modules: Console, Telnet, SSH, Web, 802.1X, MAC-based Access Control, JWAC, and WAC.

The description that follows explains the following RADIUS Attributes Assignment types:

- Privilege Level
- Ingress/Egress Bandwidth
- 802.1p Default Priority
- VLAN
- ACL

To assign the **Privilege Level** by the RADIUS server, the proper parameters should be configured on the RADIUS server. The table below shows the parameters for the bandwidth.

The parameters of the Vendor-Specific attributes are:

Vendor-Specific Attribute	Description	Value	Usage
Vendor-ID	Defines the vendor.	171 (DLINK)	Required
Vendor-Type	Defines the attribute.	1	Required
Attribute-Specific Field	Used to assign the privilege level of the user to operate the switch.	Range (1-15)	Required

If the user has configured the privilege level attribute of the RADIUS server (for example, level 15) and the Console, Telnet, SSH, and Web authentication is successful, the device will assign the privilege level (according to the RADIUS server) to this access user. However, if the user does not configure the privilege level attribute and authenticates successfully, the device will not assign any privilege level to the access user. If the privilege level is configured less than the minimum supported value or greater than the maximum supported value, the privilege level will be ignored.

To assign the **Ingress/Egress Bandwidth** by the RADIUS server, the proper parameters should be configured on the RADIUS Server. The table below shows the parameters for bandwidth.

The parameters of the Vendor-Specific attributes are:

Vendor-Specific Attribute	Description	Value	Usage
Vendor-ID	Defines the vendor.	171 (DLINK)	Required
Vendor-Type	Defines the attribute.	2 (for ingress bandwidth) 3 (for egress bandwidth)	Required
Attribute-Specific Field	Used to assign the bandwidth of a port.	Unit (Kbits)	Required

If the user has configured the bandwidth attribute of the RADIUS server (for example, ingress bandwidth 1000Kbps), and 802.1X, MAC-based Access Control, JWAC or WAC authentication is successful, the device will assign the bandwidth (according to the RADIUS server) to the port. However, if the user does

not configure the bandwidth attribute and authenticates successfully, the device will not assign any bandwidth to the port. If the bandwidth attribute is configured on the RADIUS server with a value of “0”, the effective bandwidth will be set “no_limited”, and if the bandwidth is configured less than “0” or greater than maximum supported value, the bandwidth will be ignored.

To assign the **802.1p Default Priority** by the RADIUS server, the proper parameters should be configured on the RADIUS server. The table below shows the parameters for 802.1p default priority.

The parameters of the Vendor-Specific attributes are:

Vendor-Specific Attribute	Description	Value	Usage
Vendor-ID	Defines the vendor.	171 (DLINK)	Required
Vendor-Type	Defines the attribute.	4	Required
Attribute-Specific Field	Used to assign the 802.1p default priority of the port.	0 to 7	Required

If the user has configured the 802.1p priority attribute of the RADIUS server (for example, priority 7) and 802.1X, MAC-based Access Control, JWAC or WAC authentication is successful, the device will assign the 802.1p default priority (according to the RADIUS server) to the port. However, if the user does not configure the priority attribute and authenticates successfully, the device will not assign a priority to this port. If the priority attribute is configured on the RADIUS server is a value out of range (>7), it will not be set to the device.

To assign the **VLAN** by the RADIUS server, the proper parameters should be configured on the RADIUS server. To use VLAN assignment, RFC 3580 defines the following tunnel attributes in RADIUS packets.

The table below shows the parameters for a VLAN:

RADIUS Tunnel Attribute	Description	Value	Usage
Tunnel-Type	This attribute indicates the tunneling protocol(s) to be used (in the case of a tunnel initiator) or the tunneling protocol in use (in the case of a tunnel terminator).	13 (VLAN)	Required
Tunnel-Medium-Type	This attribute indicates the transport medium being used.	6 (802)	Required
Tunnel-Private-Group-ID	This attribute indicates group ID for a particular tunneled session.	A string (VID)	Required

A summary of the Tunnel-Private-Group-ID Attribute format is shown below.

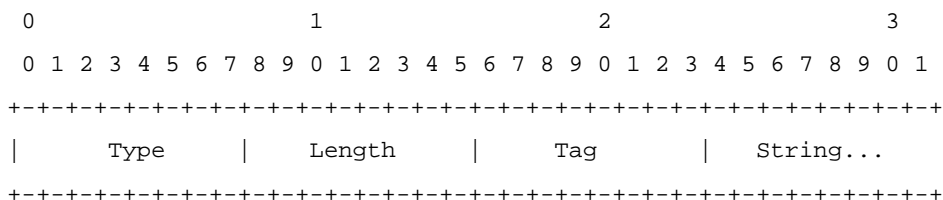

The table below shows the definition of Tag field (different with RFC 2868):

Tag field value	String field format
0x01	VLAN name (ASCII)
0x02	VLAN ID (ASCII)
Others (0x00, 0x03 ~ 0x1F, >0x1F)	When the switch receives the VLAN setting string, it will think it is the VLAN ID first. In other words, the switch will check all existing VLAN IDs and check if there is one matched. If the switch can find one matched, it will move to that VLAN. If the switch cannot find the matched VLAN ID, it will think the VLAN setting string as a "VLAN Name". Then it will check that it can find out a matched VLAN Name.



NOTE: A tag field of greater than 0x1F is interpreted as the first octet of the following field.

If the user has configured the VLAN attribute of the RADIUS server (for example, VID 3), and the 802.1X, MAC-based Access Control, JWAC or WAC authentication is successful, the port will be assigned to VLAN 3. However if the user does not configure the VLAN attributes, when the port is not guest VLAN member, it will be kept in its current authentication VLAN, and when the port is guest VLAN member, it will be assigned to its original VLAN.

To assign the **ACL** by the RADIUS server, the proper parameters should be configured on the RADIUS server. The table below shows the parameters for an ACL.

The parameters of the Vendor-Specific Attribute are:

RADIUS Tunnel Attribute	Description	Value	Usage
Vendor-ID	Defines the vendor.	171 (DLINK)	Required
Vendor-Type	Defines the attribute.	14 (for ACL script)	Required
Attribute-Specific Field	Used to assign the ACL script. The format is based on Access Control List (ACL) Commands .	ACL Script For example: ip access-list a1;permit host 10.90.90.100;exit; mac access-list extended m1;permit host 00-00-00-01-90-10 any; exit;	Required

If the user has configured the ACL attribute of the RADIUS server (for example, ACL script: ip access-list a1;permit host 10.90.90.100;exit; mac access-list extended m1;permit host 00-00-00-01-90-10 any; exit;), and the 802.1X, MAC-based Access Control, JWAC or WAC authentication is successful, the device will assign the ACL script according to the RADIUS server. The enter **Access-List Configuration Mode** and exit **Access-List Configuration Mode** must be a pair, otherwise the ACP script will be reject. For more information about the ACL module, please refer to **Access Control List (ACL) Commands** chapter.

Appendix D - IETF RADIUS Attributes Support

Remote Authentication Dial-In User Service (RADIUS) attributes carry specific authentication, authorization, information and configuration details for the request and reply. This appendix lists the RADIUS attributes currently supported by the switch.

RADIUS attributes are supported by the IETF standard and Vendor-Specific Attribute (VSA). VSA allows the vendor to create an additionally owned RADIUS attribute. For more information about D-Link VSA, refer to the **RADIUS Attributes Assignment** Appendix.

IETF standard RADIUS attributes are defined in the RFC 2865 Remote Authentication Dial-In User Service (RADIUS), RFC 2866 RADIUS Accounting, RFC 2868 RADIUS Attributes for Tunnel Protocol Support, and RFC 2869 RADIUS Extensions.

The following table lists the IETF RADIUS attributes supported by the D-Link switch.

RADIUS Authentication Attributes:

Number	IETF Attribute
1	User-Name
2	User-Password
3	CHAP-Password
4	NAS-IP-Address
5	NAS-Port
6	Service-Type
7	Framed-Protocol
8	Framed-IP-Address
12	Framed-MTU
18	Reply-Message
24	State
26	Vendor-Specific
27	Session-Timeout
29	Termination-Action
30	Called-Station-ID
31	Calling-Station-ID
32	NAS-Identifier
60	CHAP-Challenge
61	NAS-Port-Type
64	Tunnel-Type
65	Tunnel-Medium-Type
77	Connect-Info
79	EAP-Message

80	Message-Authenticator
81	Tunnel-Private-Group-ID
85	Acct-Interim-Interval
87	NAS-Port-ID
95	NAS-IPv6-Address

RADIUS Accounting Attributes:

Number	IETF Attribute
1	User-Name
4	NAS-IP-Address
5	NAS-Port
6	Service-Type
8	Framed-IP-Address
31	Calling-Station-ID
32	NAS-Identifier
40	Acct-Status-Type
41	Acct-Delay-Time
42	Acct-Input-Octets
43	Acct-Output-Octets
44	Acct-Session-ID
45	Acct-Authentic
46	Acct-Session-Time
47	Acct-Input-Packets
48	Acct-Output-Packets
49	Acct-Terminate-Cause
52	Acct-Input-Gigawords
53	Acct-Output-Gigawords
61	NAS-Port-Type
95	NAS-IPv6-Address
