



**X S T A C K**<sup>®</sup>

# Hardware Installation Guide

Product Model: xStack<sup>®</sup> DGS-3400 Series

Layer 2 Managed Gigabit Ethernet Switch

Release 2.7



Information in this document is subject to change without notice.

© 2010 D-Link Corporation. All rights reserved.

Reproduction in any manner whatsoever without the written permission of D-Link Corporation is strictly forbidden.

Trademarks used in this text: D-Link and the D-LINK logo are trademarks of D-Link Corporation; Microsoft and Windows are registered trademarks of Microsoft Corporation.

Other trademarks and trade names may be used in this document to refer to either the entities claiming the marks and names or their products. D-Link Corporation disclaims any proprietary interest in trademarks and trade names other than its own.

March 2010 P/N: 651GS34XX015G

**FCC Warning**

This equipment has been tested and found to comply with the limits for a Class A digital device, pursuant to Part 15 of the FCC Rules. These limits are designed to provide reasonable protection against harmful interference when the equipment is operated in a commercial environment. This equipment generates, uses, and can radiate radio frequency energy and, if not installed and used in accordance with this manual, may cause harmful interference to radio communications. Operation of this equipment in a residential area is likely to cause harmful interference in which case the user will be required to correct the interference at their expense.

**CE Mark Warning**

This is a Class A product. In a domestic environment, this product may cause radio interference in which case the user may be required to take adequate measures.

**Warnung!**

Dies ist ein Produkt der Klasse A. Im Wohnbereich kann dieses Produkt Funkstörungen verursachen. In diesem Fall kann vom Benutzer verlangt werden, angemessene Massnahmen zu ergreifen.

**Precaución!**

Este es un producto de Clase A. En un entorno doméstico, puede causar interferencias de radio, en cuyo caso, puede requerirse al usuario para que adopte las medidas adecuadas.

**Attention!**

Ceci est un produit de classe A. Dans un environnement domestique, ce produit pourrait causer des interférences radio, auquel cas l'utilisateur devrait prendre les mesures adéquates.

**Attenzione!**

Il presente prodotto appartiene alla classe A. Se utilizzato in ambiente domestico il prodotto può causare interferenze radio, nel cui caso è possibile che l'utente debba assumere provvedimenti adeguati.

**VCCI Warning**

この装置は、クラス A 情報技術装置です。この装置を家庭環境で使用すると電波妨害を引き起こすことがあります。この場合には使用者が適切な対策を講ずるよう要求されることがあります。 VCCI-A

**CCC Class A Warning**

**A类设备声明**

此为A类产品，在生活环境中，让产品可能会造成无线电干扰，在这种情况下，可能需要用户对其干扰采取切实可的防护措施。

# Table of Contents

Intended Readers .....	v
Typographical Conventions .....	v
Notes, Notices, and Cautions .....	v
Safety Instructions.....	vi
Safety Cautions .....	vi
General Precautions for Rack-Mountable Products .....	vii
Lithium Battery Precaution.....	viii
Protecting Against Electrostatic Discharge .....	viii
<b>Introduction.....</b>	<b>1</b>
Switch Description .....	1
Ports .....	2
Front-Panel Components.....	3
LED Indicators .....	4
Rear Panel Description.....	6
Side Panel Description .....	7
<b>Installation.....</b>	<b>8</b>
Package Contents .....	8
Installation Guidelines .....	8
Installing the Switch without the Rack.....	9
Installing the Switch in a Rack.....	9
Mounting the Switch in a Standard 19" Rack .....	10
Power On .....	10
Power Failure.....	10
Installing the SFP Ports.....	11
The Optional Module .....	12
Installing the Module .....	13
External Redundant Power System .....	14
<b>Connecting the Switch.....</b>	<b>16</b>
Switch to End Node .....	16
Switch to Switch .....	16
Connecting To Network Backbone or Server .....	17
<b>Introduction to Switch Management .....</b>	<b>18</b>
Management Options .....	18
Connecting the Console Port (RS-232 DCE).....	19
Managing the Switch for the First Time .....	20
Password Protection.....	21
SNMP Settings.....	22
Traps .....	22
MIBs .....	22
IP Address Assignment.....	22
<b>Web-based Switch Configuration.....</b>	<b>25</b>
Introduction.....	25
Logging in to the Web Manager .....	26
Web-based User Interface .....	27
Areas of the User Interface .....	27
Web Pages.....	28
<b>Technical Specifications .....</b>	<b>29</b>
<b>Cables and Connectors.....</b>	<b>31</b>

<b>Cable Lengths.....</b>	<b>32</b>
<b>Glossary .....</b>	<b>33</b>
<b>Warranties and Tech Support Information .....</b>	<b>35</b>

## Intended Readers

The *xStack® DGS-3400 Series Manual* contains information for setup and management of the Switch. This manual is intended for network managers familiar with network management concepts and terminology.

## Typographical Conventions

Convention	Description
[ ]	In a command line, square brackets indicate an optional entry. For example: [ copy filename] means that optionally you can type copy followed by the name of the file. Do not type the brackets.
<b>Bold font</b>	Indicates a button, a toolbar icon, menu, or menu item. For example: Open the <b>File</b> menu and choose <b>Cancel</b> . Used for emphasis. May also indicate system messages or prompts appearing on screen. For example: <b>You have mail</b> . <b>Bold</b> font is also used to represent filenames, program names and commands. For example: <b>use the copy command</b> .
<b>Boldface Typewriter Font</b>	Indicates commands and responses to prompts that must be typed exactly as printed in the manual.
Initial capital letter	Indicates a window name. Names of keys on the keyboard have initial capitals. For example: Click Enter.
<i>Italics</i>	Indicates a window name or a field. Also can indicate a variables or parameter that is replaced with an appropriate word or string. For example: type <i>filename</i> means that the actual filename should be typed instead of the word shown in italic.
<b>Menu Name &gt; Menu Option</b>	<b>Menu Name &gt; Menu Option</b> Indicates the menu structure. <b>Device &gt; Port &gt; Port Properties</b> means the Port Properties menu option under the Port menu option that is located under the Device menu.

## Notes, Notices, and Cautions



A **NOTE** indicates important information that helps make better use of the device.



A **NOTICE** indicates either potential damage to hardware or loss of data and tells how to avoid the problem.



A **CAUTION** indicates a potential for property damage, personal injury, or death.

## Safety Instructions

Use the following safety guidelines to ensure your own personal safety and to help protect your system from potential damage.

Throughout this safety section, the caution icon (  ) is used to indicate cautions and precautions that need to be reviewed and followed.



### Safety Cautions

To reduce the risk of bodily injury, electrical shock, fire, and damage to the equipment observe the following precautions:

- Observe and follow service markings.
  - Do not service any product except as explained in the system documentation.
  - Opening or removing covers that are marked with the triangular symbol with a lightning bolt may expose the user to electrical shock.
  - Only a trained service technician should service components inside these compartments.
- If any of the following conditions occur, unplug the product from the electrical outlet and replace the part or contact your trained service provider:
  - Damage to the power cable, extension cable, or plug.
  - An object has fallen into the product.
  - The product has been exposed to water.
  - The product has been dropped or damaged.
  - The product does not operate correctly when the operating instructions are correctly followed.
- Keep your system away from radiators and heat sources. Also, do not block cooling vents.
- Do not spill food or liquids on system components, and never operate the product in a wet environment. If the system gets wet, see the appropriate section in the troubleshooting guide or contact your trained service provider.
- Do not push any objects into the openings of the system. Doing so can cause fire or electric shock by shorting out interior components.
- Use the product only with approved equipment.
- Allow the product to cool before removing covers or touching internal components.
- Operate the product only from the type of external power source indicated on the electrical ratings label. If unsure of the type of power source required, consult your service provider or local power company.
- To help avoid damaging the system, be sure the voltage selection switch (if provided) on the power supply is set to match the power available at the Switch's location:
  - 115 volts (V)/60 hertz (Hz) in most of North and South America and some Far Eastern countries such as South Korea and Taiwan
  - 100 V/50 Hz in eastern Japan and 100 V/60 Hz in western Japan
  - 230 V/50 Hz in most of Europe, the Middle East, and the Far East
- Also, be sure that attached devices are electrically rated to operate with the power available in your location.
- Use only approved power cable(s). If you have not been provided with a power cable for your system or for any AC-powered option intended for your system, purchase a power cable that is approved for use in your country. The power cable must be rated for the product and for the voltage and current marked on the product's electrical ratings label. The voltage and current rating of the cable should be greater than the ratings marked on the product.

- To help prevent electric shock, plug the system and peripheral power cables into properly grounded electrical outlets. These cables are equipped with three-prong plugs to help ensure proper grounding. Do not use adapter plugs or remove the grounding prong from a cable. If using an extension cable is necessary, use a 3-wire cable with properly grounded plugs.
- Observe extension cable and power strip ratings. Make sure that the total ampere rating of all products plugged into the extension cable or power strip does not exceed 80 percent of the ampere ratings limit for the extension cable or power strip.
- To help protect the system from sudden, transient increases and decreases in electrical power, use a surge suppressor, line conditioner, or uninterruptible power supply (UPS).
- Position system cables and power cables carefully; route cables so that they cannot be stepped on or tripped over. Be sure that nothing rests on any cables.
- Do not modify power cables or plugs. Consult a licensed electrician or your power company for site modifications. Always follow your local/national wiring rules.
- When connecting or disconnecting power to hot-pluggable power supplies, if offered with your system, observe the following guidelines:
  - Install the power supply before connecting the power cable to the power supply.
  - Unplug the power cable before removing the power supply.
  - If the system has multiple sources of power, disconnect power from the system by unplugging all power cables from the power supplies.
- Move products with care; ensure that all casters and/or stabilizers are firmly connected to the system. Avoid sudden stops and uneven surfaces.



## General Precautions for Rack-Mountable Products

Observe the following precautions for rack stability and safety. Also, refer to the rack installation documentation accompanying the system and the rack for specific caution statements and procedures.

- Systems are considered to be components in a rack. Thus, "component" refers to any system as well as to various peripherals or supporting hardware.



**CAUTION:** Installing systems in a rack without the front and side stabilizers installed could cause the rack to tip over, potentially resulting in bodily injury under certain circumstances. Therefore, always install the stabilizers before installing components in the rack. After installing system/components in a rack, never pull more than one component out of the rack on its slide assembles at one time. The weight of more than one extended component could cause the rack to tip over and may result in serious injury.

- Before working on the rack, make sure that the stabilizers are secured to the rack, extended to the floor, and that the full weight of the rack rests on the floor. Install front and side stabilizers on a single rack or front stabilizers for joined multiple racks before working on the rack.
- Always load the rack from the bottom up, and load the heaviest item in the rack first.
- Make sure that the rack is level and stable before extending a component from the rack.
- Use caution when pressing the component rail release latches and sliding a component into or out of a rack; the slide rails can pinch your fingers.
- After a component is inserted into the rack, carefully extend the rail into a locking position, and then slide the component into the rack.
- Do not overload the AC supply branch circuit that provides power to the rack. The total rack load should not exceed 80 percent of the branch circuit rating.
- Ensure that proper airflow is provided to components in the rack.



- Do not step on or stand on any component when servicing other components in a rack.



**NOTE:** A qualified electrician must perform all connections to DC power and to safety grounds. All electrical wiring must comply with applicable local or national codes and practices.



**CAUTION:** Never defeat the ground conductor or operate the equipment in the absence of a suitably installed ground conductor. Contact the appropriate electrical inspection authority or an electrician if uncertain that suitable grounding is available.



**CAUTION:** The system chassis must be positively grounded to the rack cabinet frame. Do not attempt to connect power to the system until grounding cables are connected. Completed power and safety ground wiring must be inspected by a qualified electrical inspector. An energy hazard will exist if the safety ground cable is omitted or disconnected.

## Lithium Battery Precaution



**CAUTION:** Incorrectly replacing the lithium battery of the Switch may cause the battery to explode. Replace this battery only with the same or equivalent type recommended by the manufacturer. Discard used batteries according to the manufacturer instructions.

## Protecting Against Electrostatic Discharge

Static electricity can harm delicate components inside the system. To prevent static damage, discharge static electricity from your body before touching any of the electronic components, such as the microprocessor. This can be done by periodically touching an unpainted metal surface on the chassis.

The following steps can also be taken prevent damage from electrostatic discharge (ESD):

1. When unpacking a static-sensitive component from its shipping carton, do not remove the component from the antistatic packing material until ready to install the component in the system. Just before unwrapping the antistatic packaging, be sure to discharge static electricity from your body.
2. When transporting a sensitive component, first place it in an antistatic container or packaging.
3. Handle all sensitive components in a static-safe area. If possible, use antistatic floor pads, workbench pads and an antistatic grounding strap.

# Introduction

## ***Switch Description***

### ***Front-Panel Components***

### ***LED Indicators***

### ***Rear Panel Description***

### ***Side Panel Description***

The DGS-3400 Gigabit Ethernet switches are members of the D-Link xStack® family. Ranging from 10/100Mbps edge switches to core gigabit switches, the xStack® switch family has been future-proof designed to deliver a system with fault tolerance, flexibility, port density, robust security and maximum throughput with a user-friendly management interface for the networking professional.

This manual describes the installation, maintenance and configurations concerning members of the xStack® DGS-3400 Series. These switches include: the DGS-3426, DGS-3426P, DGS-3427 and the DGS-3450. The xStack® DGS-3400 Series are similar in configurations and basic hardware and consequentially, most of the information in this manual will be universal to the whole xStack® DGS-3400 Series. Corresponding screen pictures of the web manager may be taken from any one of these switches but the configuration will be identical, except for varying port counts.

# Switch Description

D-Link's next-generation xStack® DGS-3400 Series switches are high port-density stackable switches that combine the ultimate performance with fault tolerance, security, management functions with flexibility and ease-of-use. All these features, typically found in the more expensive chassis-based solutions, are available from the xStack® DGS-3400 Series at the price of a stackable switch.

All xStack® DGS-3400 Series switches have some combination of 1000BASE-T ports, SFP ports and 10-Gigabit ports that may be used in uplinking various network devices to the Switch, including PCs, hubs and other switches to provide a gigabit Ethernet uplink in full-duplex mode. The SFP (Small Form Factor Portable) combo ports are used with fiber-optical transceiver cabling in order to uplink various other networking devices for a gigabit link that may span great distances. These SFP ports support full-duplex transmissions, have auto-negotiation and can be used with DEM-310GT (1000BASE-LX), DEM-311GT (1000BASE-SX), DEM-314GT (1000BASE-LH), DEM-312GT2 (100BASE-SX) and DEM-315GT (1000BASE-ZX) transceivers. Users may also use one of the WDM Single Mode Transceivers, such as the DEM-330T/R or the DEM-331T/R. The rear panel of the xStack® DGS-3400 Series includes spaces for optional single-port module inserts for single port 10GE XFP or 10GBASE-CX4 modules used for backbone uplink or stacking connection to another xStack® DGS-3400 Series.

## Ports

The xStack® DGS-3400 Series port options, as listed by device.

<b>DGS-3426</b>	<b>DGS-3426P</b>	<b>DGS-3427</b>	<b>DGS-3450</b>
<ul style="list-style-type: none"><li>• Twenty-four 10/100/1000BASE-T Gigabit ports</li><li>• Four Combo SFP Ports</li><li>• Two slots open for single port 10GE XFP or 10GBASE-CX4 modules</li><li>• One RS-232 DB-9 console port</li></ul>	<ul style="list-style-type: none"><li>• Twenty-four PoE Compliant 10/100/1000BASE-T Gigabit ports</li><li>• Four Combo SFP Ports</li><li>• Two slots open for single port 10GE XFP or 10GBASE-CX4 modules</li><li>• One RS-232 DB-9 console port</li></ul>	<ul style="list-style-type: none"><li>• Twenty-four 10/100/1000BASE-T Gigabit ports</li><li>• Four Combo SFP Ports</li><li>• Three slots open for single port 10GE XFP or 10GBASE-CX4 modules</li><li>• One RS-232 DB-9 console port</li></ul>	<ul style="list-style-type: none"><li>• Forty-eight 10/100/1000BASE-T Gigabit ports</li><li>• Four Combo SFP Ports</li><li>• Two slots open for single port 10GE XFP or 10GBASE-CX4 modules</li><li>• One RS-232 DB-9 console port</li></ul>



**NOTE:** For customers interested in D-View, D-Link Corporation's proprietary SNMP management software, go to the D-Link Website and download the software and manual.

## Front-Panel Components

The front panel of the Switch consists of LED indicators for Power, Master, Console, RPS, and for Link/Act for each port on the Switch including 10GE Ports for optional modules and SFP port LEDs. The front panel includes a seven-segment LED indicating the Stack ID number. A separate table below describes LED indicators in more detail. DGS-3426P also includes a Mode Select button for changing the mode Link/Act/State to PoE.

### DGS-3426

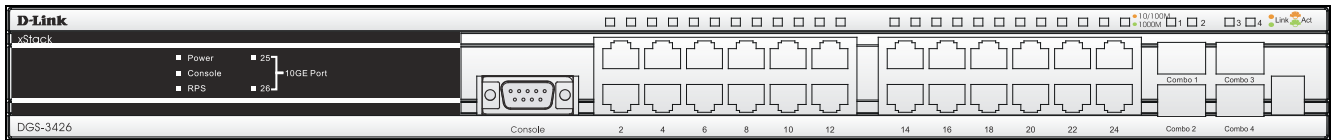

**Figure 1 - 1 Front Panel View of the DGS-3426**

### DGS-3426P

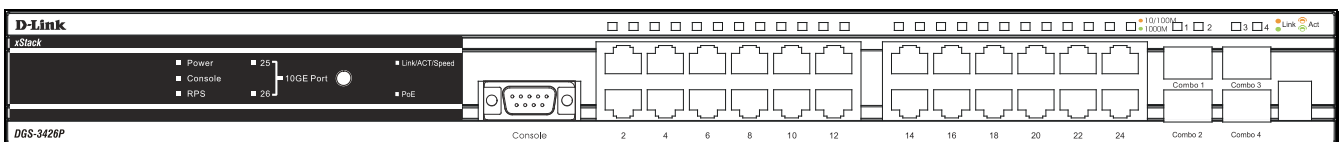

**Figure 1 - 2 Front Panel View of the DGS-3426P**

### DGS-3427

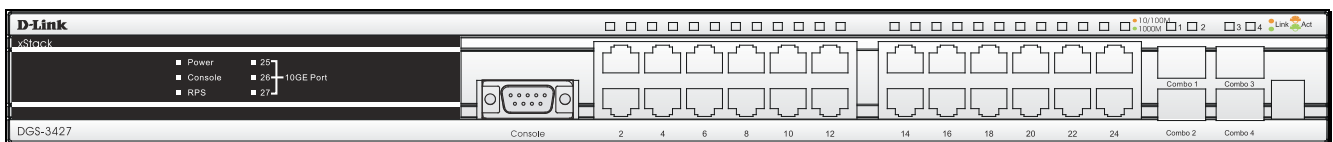

**Figure 1 - 3 Front Panel View of the DGS-3427**

### DGS-3450

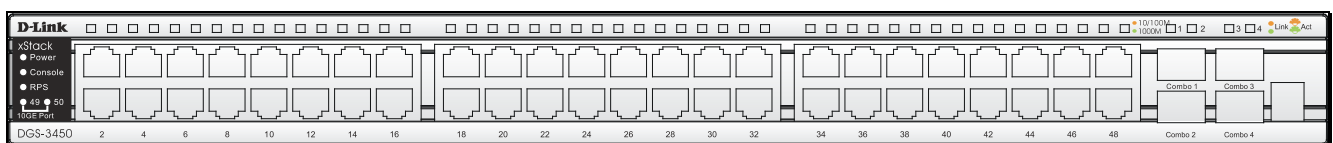

**Figure 1 - 4 Front Panel View of the DGS-3427**

## LED Indicators

The Switch supports LED indicators for Power, Console, RPS and Port LEDs including 10GE port LEDs for optional module inserts.

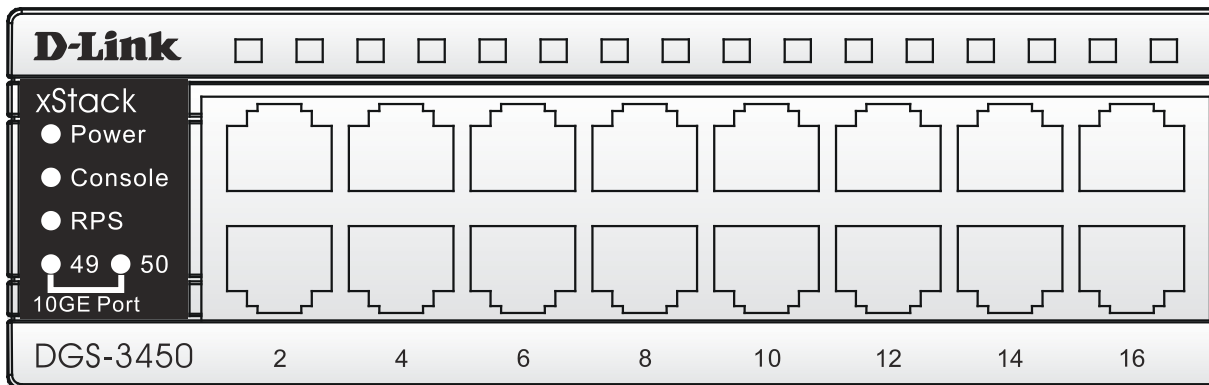

Figure 1 - 5 LED Indicators on DGS-3450

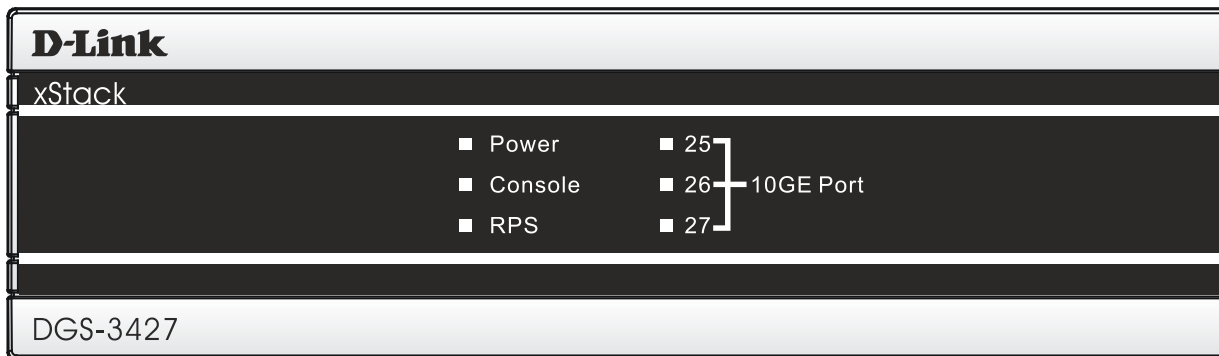

Figure 1 - 6 LED Indicators on DGS-3427

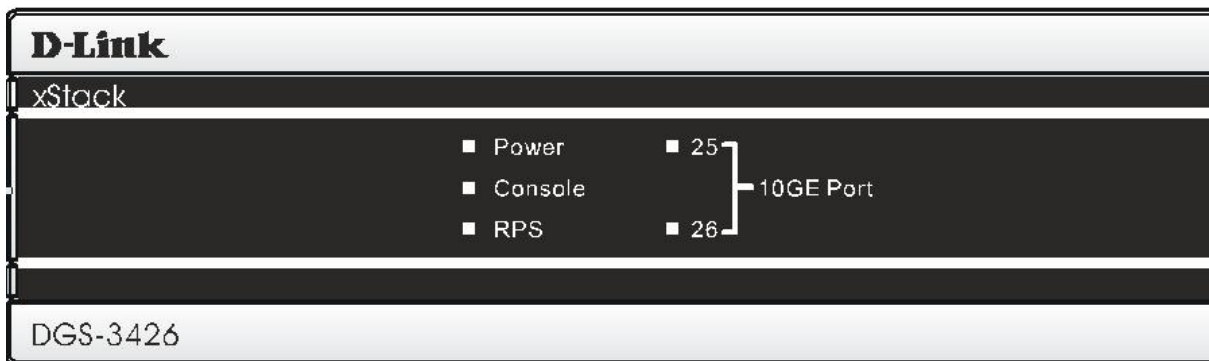

Figure 1 - 7LED Indicators on DGS-3426

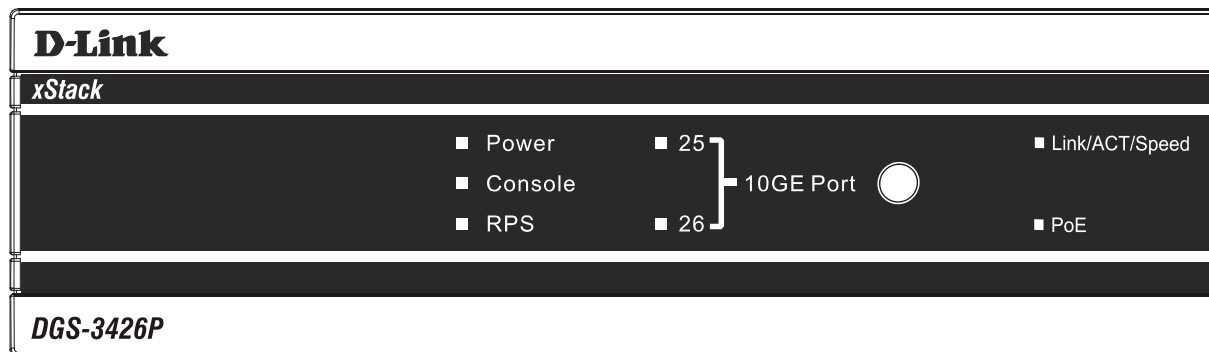

Figure 1 - 8 LED Indicators on DGS-3426P

LED	Description
<b>Power</b>	This LED will light green after powering the Switch on to indicate the ready state of the device. The indicator is dark when the Switch is no longer receiving power (i.e powered off).
<b>Console</b>	This LED will blink green during the Power-On Self Test (POST). When the POST is finished, the LED goes dark. The indicator will light steady green when an active console link is in session via RS-232 console port.
<b>RPS</b>	This LED will light when the internal power has failed and the RPS has taken over the power supply to the Switch. Otherwise, it will remain dark.
<b>Port LEDs</b>	One row of LEDs for each port is located above the ports on the front panel. The indicator above the left side of a port corresponds to the port below the indicator in the upper row of ports. The indicator above the right side of a port corresponds to the port below the indicator in the lower row of ports. A steady green light denotes a valid 1000Mbps link on the port while a blinking green light indicates activity on the port (at 1000Mbps). A steady orange light denotes a valid 10 or 100Mbps link on the port while a blinking orange light indicates activity on the port (at 100Mbps). These LEDs will remain dark if there is no link on the port.
<b>10GE Ports</b>	A steady green light denotes a valid link on the port while a blinking green light indicates activity on the port. These LEDs will remain dark if there is no link on the port.
<b>Combo SFP Ports</b>	LED indicators for the Combo ports are located above the ports and numbered 1 – 4 for Combo 1, Combo 2, etc. ports. A steady green light denotes a valid link on the port while a blinking green light indicates activity on the port. These LEDs will remain dark if there is no link on the port.
<b>Stack ID</b>	These two seven segment LEDs display the current switch stack order of the Switch while in use.
<b>Link/Act/Speed and PoE (DGS-3426P only)</b>	To change the LED mode from Link/Act/Speed to PoE and vice versa, press the LED Mode Select Button. The Link/Act/Speed LED will light solid green when selected and will shut off when PoE is selected. Likewise, when Link/Act/Speed is selected, the PoE LED shuts off and the Link/Act/Speed LED lights solid green.

## Rear Panel Description

### DGS-3426

The rear panel of the DGS-3426 contains an AC power connector, a redundant power supply connector and two empty slots for optional module inserts.



**Figure 1 - 9 Rear panel view of the DGS-3426**

### DGS-3426P

The rear panel of the DGS-3426P contains an AC power connector, a redundant power supply connector, a heat vent for the rear fan and two empty slots for optional module inserts.

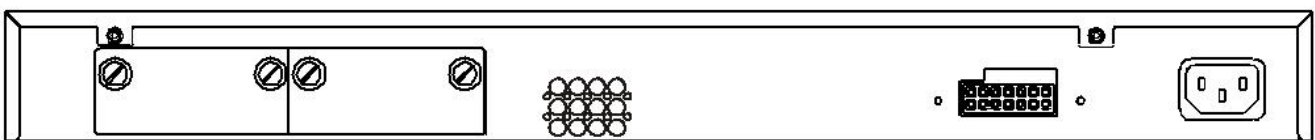

**Figure 1 - 10 Rear panel view of the DGS-3426P**

### DGS-3427

The rear panel of the DGS-3427 contains an AC power connector, a redundant power supply connector and three empty slots for optional module inserts.

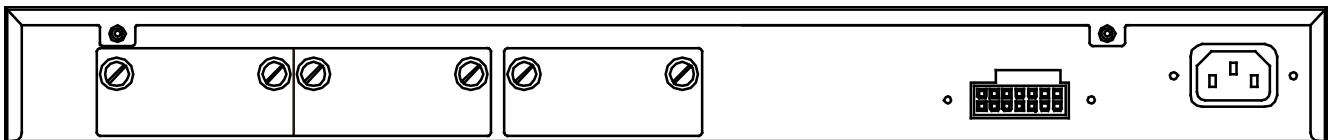

**Figure 1 - 11 Rear panel view of the DGS-3427**

### DGS-3450

The rear panel of the DGS-3450 contains an AC power connector, two empty slots for optional module inserts, a redundant power supply connector, a RS-232 DCE console port for Switch management and a system fan vent.

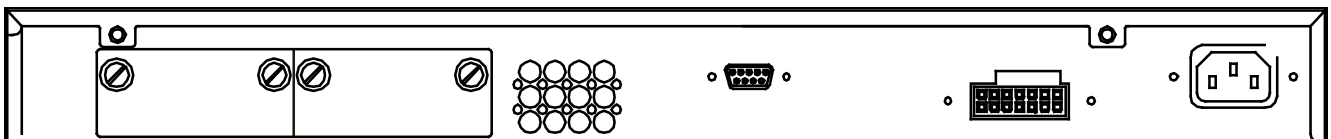

**Figure 1 - 12 Rear panel view of the DGS-3450**

The AC power connector is a standard three-pronged connector that supports the power cord. Plug-in the female connector of the provided power cord into this socket, and the male side of the cord into a power outlet. The Switch automatically adjusts its power setting to any supply voltage in the range from 100 ~ 240 VAC at 50 ~ 60 Hz.

The rear panel also includes an outlet for an optional external power supply. When a power failure occurs, the optional external RPS will automatically assume the power supply for the Switch immediately.

## Side Panel Description

The system fans and heat vents located on each side dissipate heat. Do not block these openings. Leave at least 6 inches of space at the rear and sides of the Switch for proper ventilation. Be reminded that without proper heat dissipation and air circulation, system components might overheat, which could lead to system failure and severely damage components.

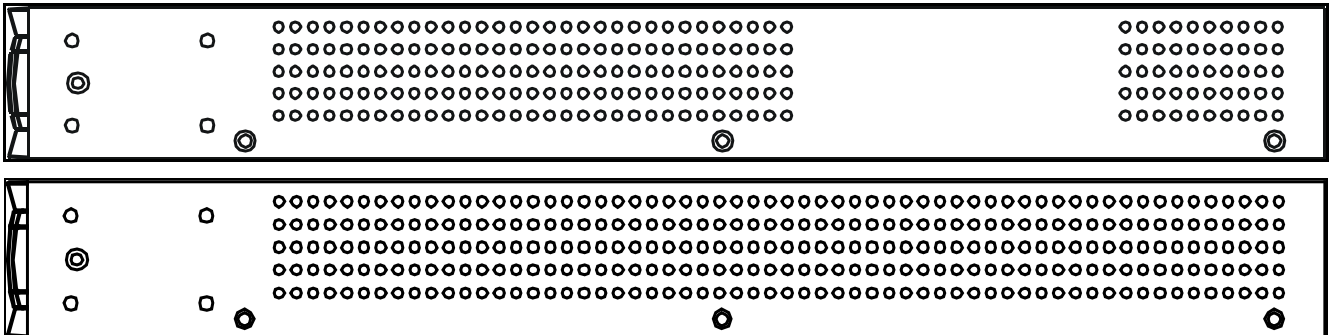

Figure 1 - 13 Side Panel view of the DGS-3450

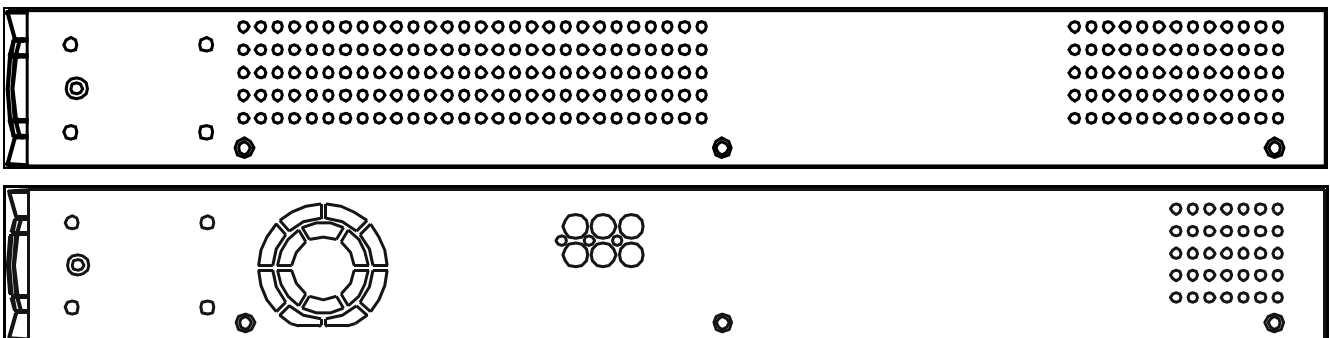

Figure 1 - 14 Side Panel view of the DGS-3426 and DGS-3427

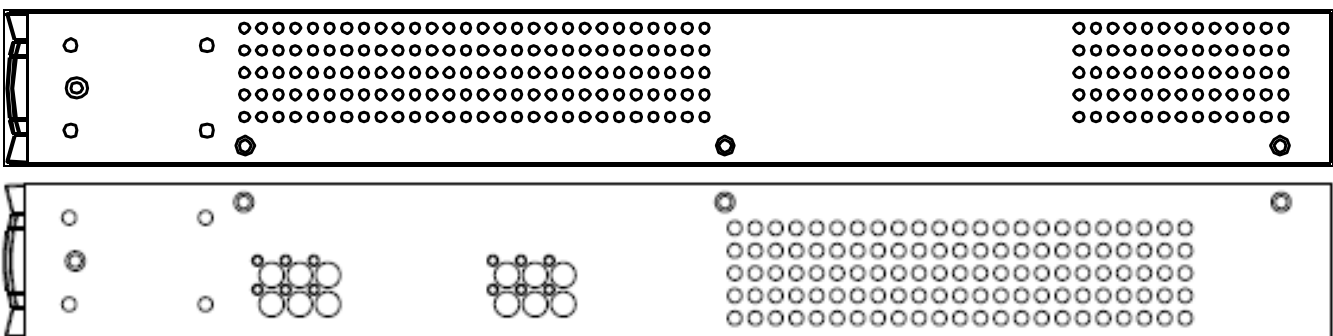

Figure 1 - 15 Side Panel view of the DGS-3426P



# Installation

## *Package Contents*

## *Installation Guidelines*

## *Installing the Switch without the Rack*

## *Installing the Switch in a Rack*

## *Mounting the Switch in a Standard 19" Rack*

## *Power On*

## *Power Failure*

## *Installing the SFP Ports*

## *The Optional Module*

## *External Redundant Power System*

# Package Contents

Open the shipping carton of the Switch and carefully unpack its contents. The carton should contain the following items:

1. One xStack® Stackable Switch
2. One AC power cord
3. Mounting kit (two brackets and screws)
4. Four rubber feet with adhesive backing
5. RS-232 console cable
6. One CD Kit for User's Guide/CLI/D-View module
7. One CD Kit for D-View 5.1 Standard version (for Europe only)
8. Registration card & China Warranty Card (for China only)

If any item is missing or damaged, please contact your local D-Link Reseller for replacement.

# Installation Guidelines

Please follow these guidelines for setting up the Switch:

- Install the Switch on a sturdy, level surface that can support at least 6.6 lb. (3 kg) of weight. Do not place heavy objects on the Switch.
- The power outlet should be within 1.82 meters (6 feet) of the Switch.
- Visually inspect the power cord and see that it is fully secured to the AC power port.
- Make sure that there is proper heat dissipation from and adequate ventilation around the Switch. Leave at least 10 cm (4 inches) of space at the front and rear of the Switch for ventilation.
- Install the Switch in a fairly cool and dry place for the acceptable temperature and humidity operating ranges.
- Install the Switch in a site free from strong electromagnetic field generators (such as motors), vibration, dust, and direct exposure to sunlight.
- When installing the Switch on a level surface, attach the rubber feet to the bottom of the device. The rubber feet cushion the Switch, protect the casing from scratches and prevent it from scratching other surfaces.

## Installing the Switch without the Rack

First, attach the rubber feet included with the Switch if installing on a desktop or shelf. Attach these cushioning feet on the bottom at each corner of the device. Allow enough ventilation space between the Switch and any other objects in the vicinity.

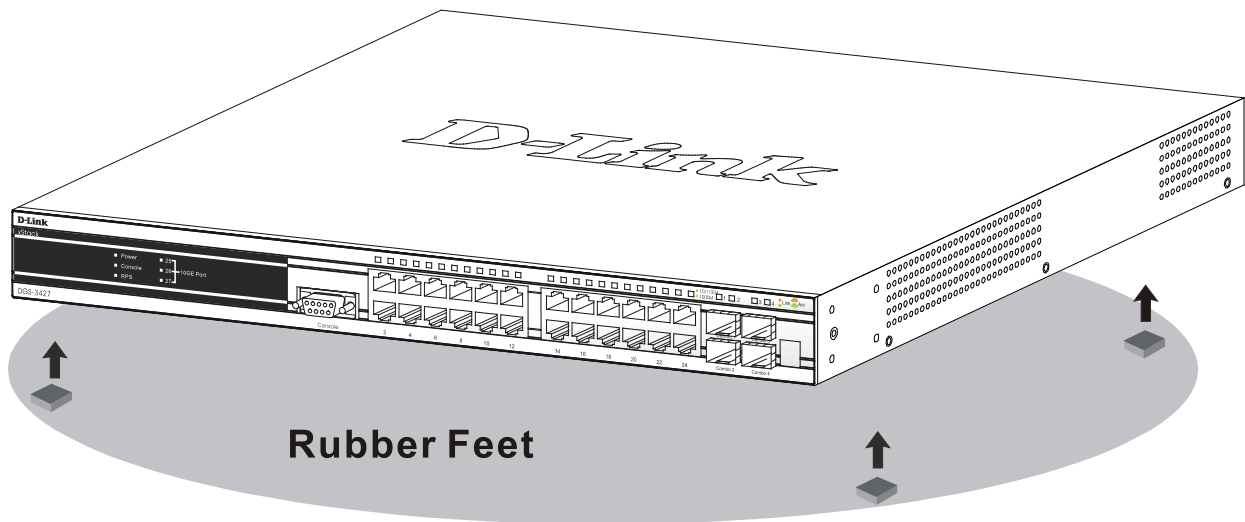

**Figure 2- 1. Prepare Switch for installation on a desktop or shelf**

## Installing the Switch in a Rack

The Switch can be mounted in a standard 19" rack. Use the following diagrams as a guide.

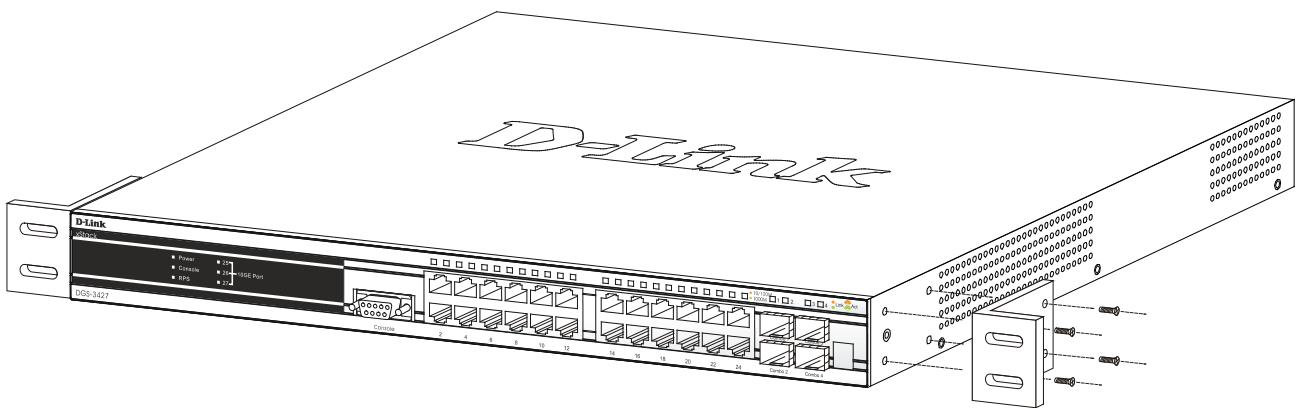

**Figure 2- 2. Fasten mounting brackets to Switch**

Fasten the mounting brackets to the Switch using the screws provided. With the brackets attached securely, the Switch can be mounted in a standard rack as shown below.

## Mounting the Switch in a Standard 19" Rack

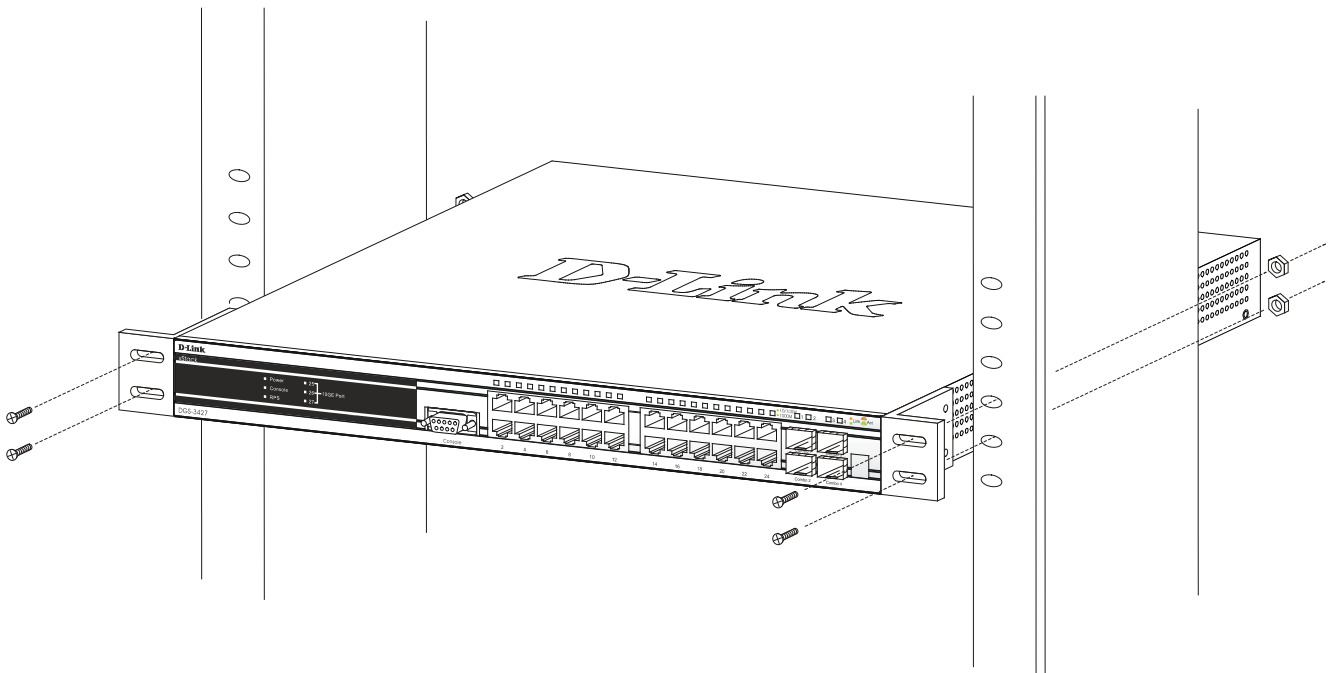

**Figure 2- 3. Installing Switch in a rack**

## Power On

1. Plug one end of the AC power cord into the power connector of the Switch and the other end into the local power source outlet.
2. After powering on the Switch, the LED indicators will momentarily blink. This blinking of the LED indicators represents a reset of the system.

## Power Failure

As a precaution, in the event of a power failure, unplug the Switch. When power is resumed, plug the Switch back in.

## Installing the SFP Ports

The xStack® DGS-3400 Series are equipped with SFP (Small Form Factor Portable) ports, which are to be used with fiber-optical transceiver cabling in order to uplink various other networking devices for a gigabit link that may span great distances. These SFP ports support full-duplex transmissions, have auto-negotiation and can be used with DEM-310GT (1000BASE-LX), DEM-311GT (1000BASE-SX), DEM-314GT (1000BASE-LH) and DEM-315GT (1000BASE-ZX) transceivers. See the figure below for installing the SFP ports in the Switch.

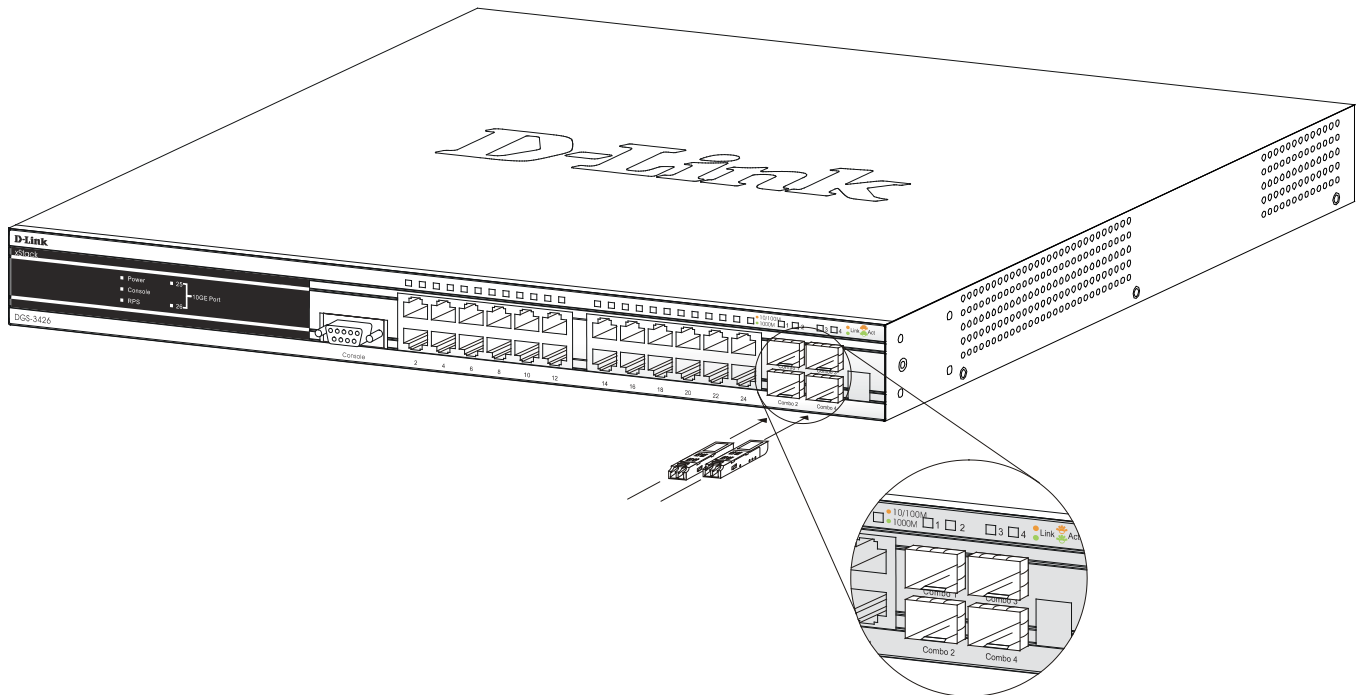

**Figure 2- 4. Inserting the fiber-optic transceivers into the DGS-3426**

## The Optional Module

The rear panel of the DGS-3426, DGS-3426P, DGS-3427 and DGS-3450 include open slots that may be equipped with the DEM-410X 1-port 10GE XFP stacking uplink module, or a DEM-410CX 1-port 10GBASE-CX4 stacking uplink module, both sold separately. These modules may be used to stack switches in a switch stack using a Duplex Ring or Duplex Chain topology.

Adding the DEM-410X optional module will allow the administrator to transmit data at a rate of ten gigabits a second. The module port(s) are compliant with standard IEEE 802.3ae, support full-duplex transmissions only and must be used with XFP MSA compliant transceivers.

The DEM-410CX uses copper wire medium, not optic fiber and therefore has a transmit length limit up to 1 meter. Compliant with the IEEE802.3ak standard, this module uses a 4-laned copper connector for data transfer in full-duplex mode within a stacking configuration.

To install these modules in the DGS-3400 Series, follow the simple steps listed below.



**CAUTION:** Before adding the optional module, make sure to disconnect all power sources connected to the Switch. Failure to do so may result in an electrical shock, which may cause damage, not only to the individual but to the Switch as well.

At the back of the Switch to the left is the slot for the optional module. This slot must be covered with the faceplate if the slot is not being used. If a module will be installed in an available slot, the faceplate is easily removed by loosening the screws and pulling off the plate.

The front panels of the available modules are shown here:

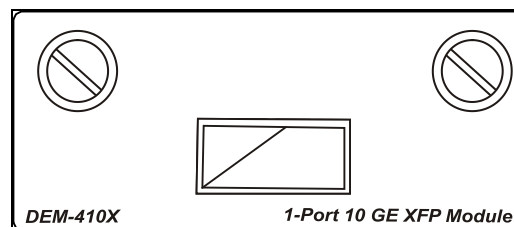

**Figure 2- 5. Front Panel of the DEM-410X**

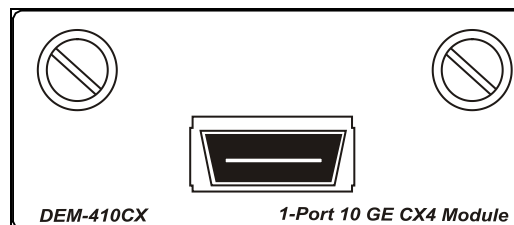

**Figure 2- 6. Front Panel of the DEM-410CX**

## Installing the Module

Unplug the Switch before removing the faceplate covering the empty slot. To install the module, slide it in to the available slot at the rear of the Switch until it reaches the back, as shown in the following figure. Gently, but firmly push in on the module to secure it to the Switch. The module should fit snugly into the corresponding receptors.

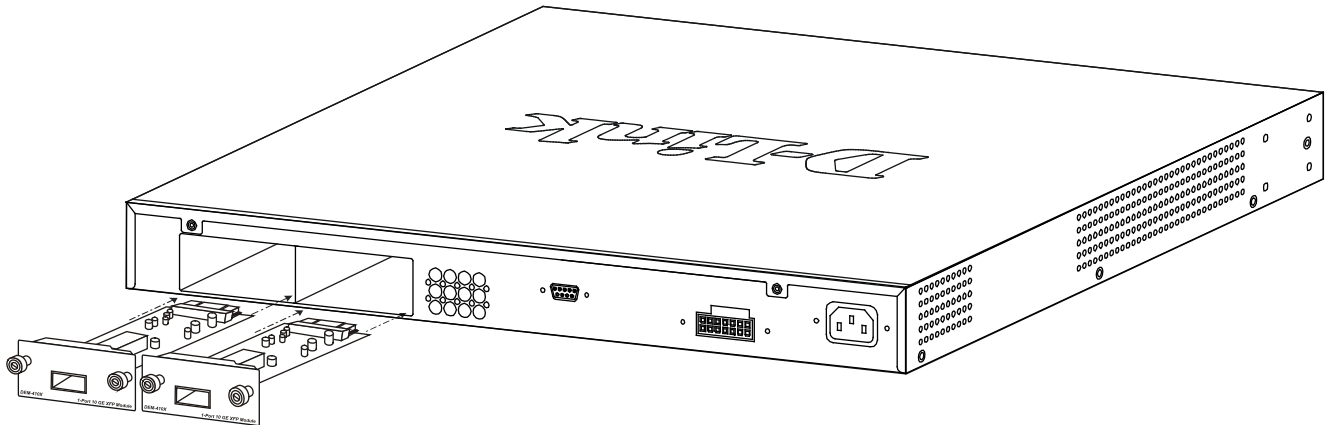

**Figure 2- 7. Inserting the optional module into the Switch (DGS-3450)**

Now tighten the two screws at adjacent ends of the module into the available screw holes on the Switch. The upgraded Switch is now ready for use.

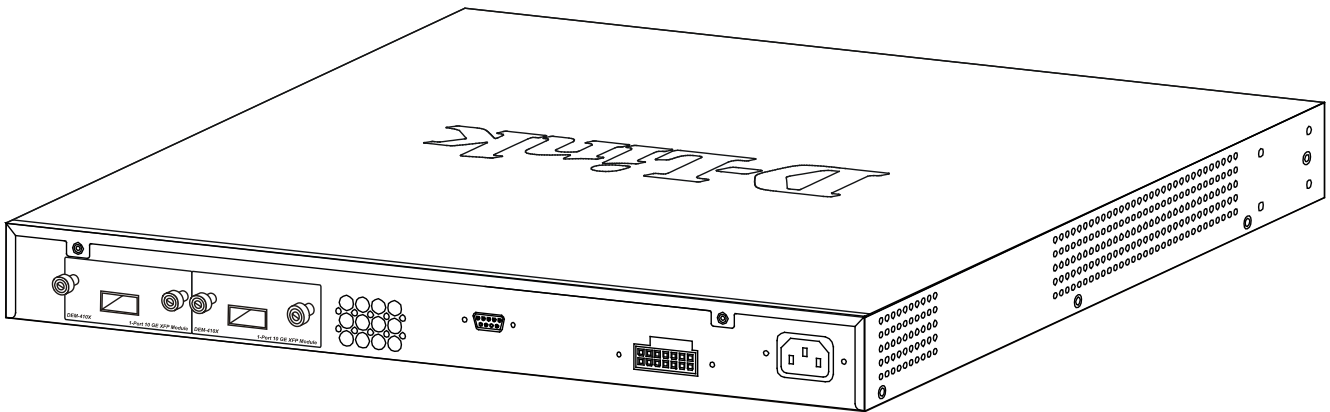

**Figure 2- 8. DGS-3450 with optional DEM-410X module installed**

## External Redundant Power System

The Switch supports an external redundant power system. The diagrams below illustrate a proper RPS power connection to the Switch. Please consult the documentation for information on power cabling and connectors and setup procedure.

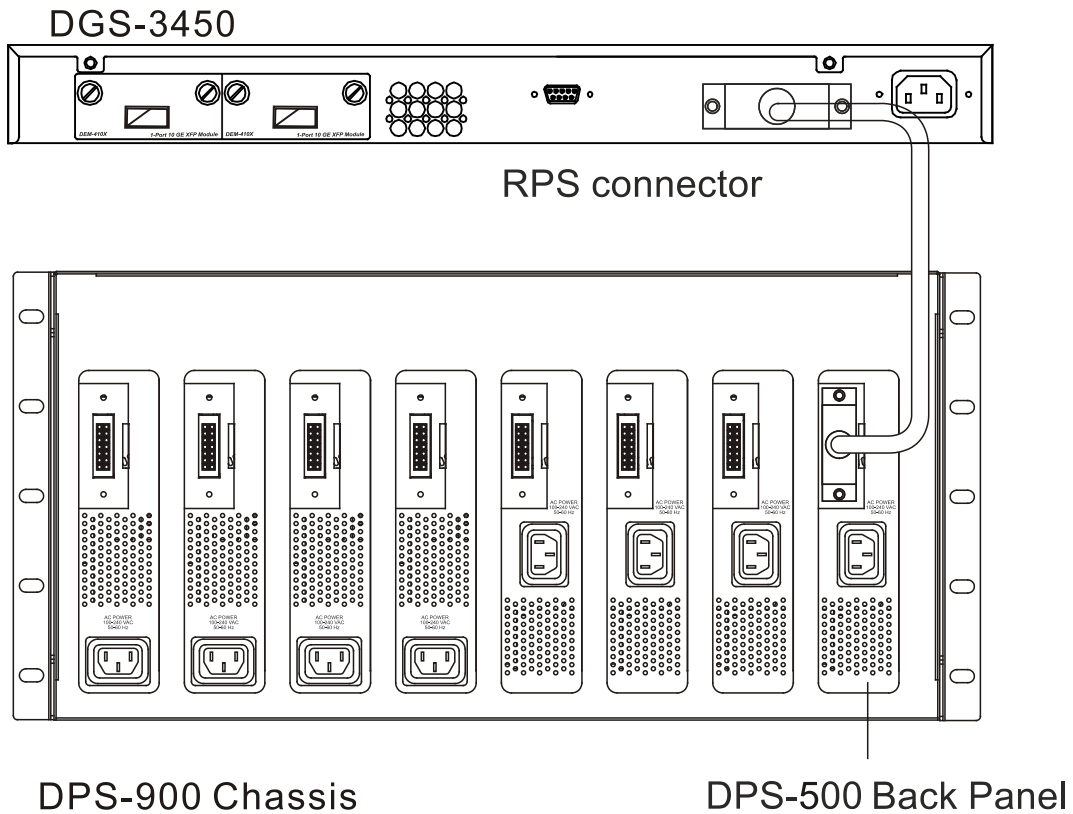

Figure 2- 9. The DGS-3450 with the DPS-500 chassis RPS

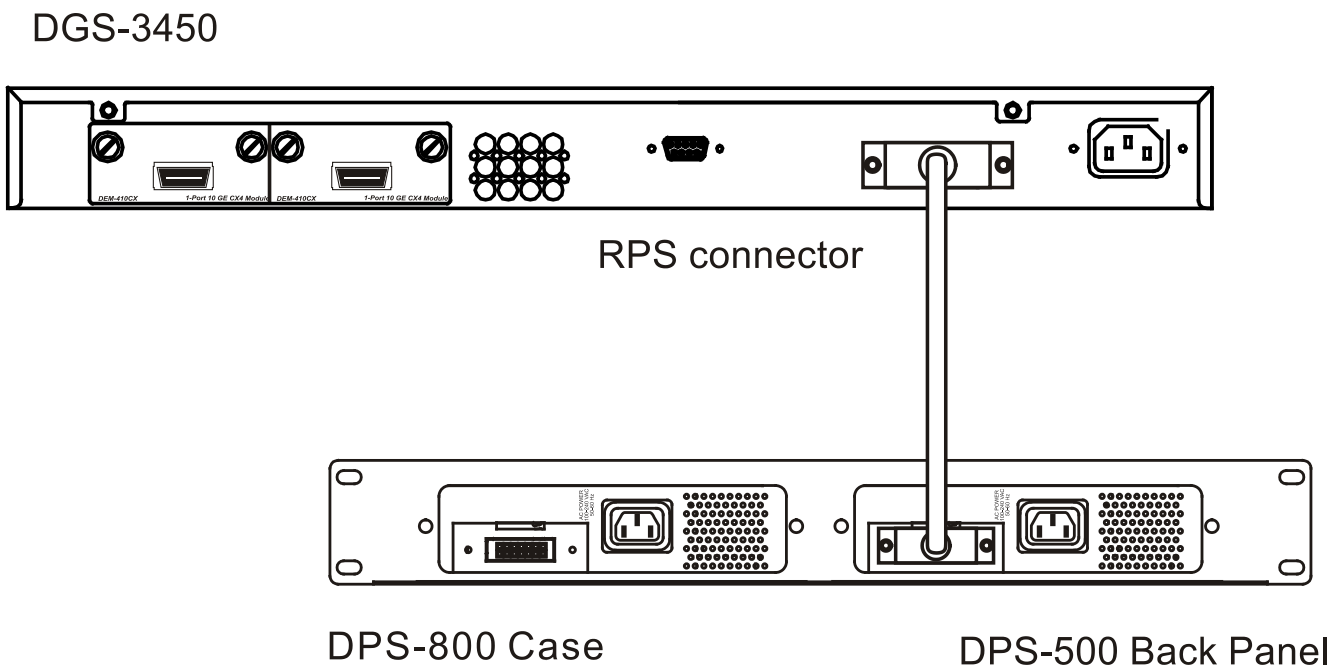
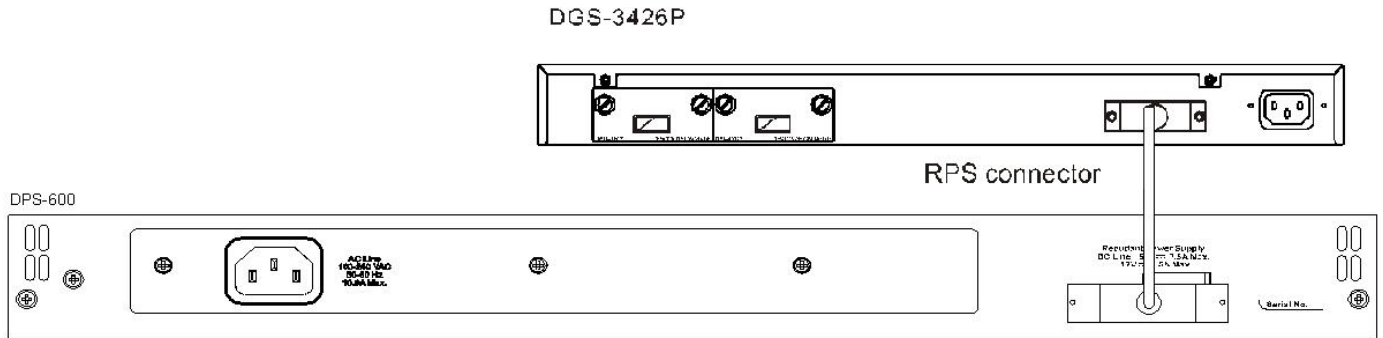

Figure 2- 10. The DGS-3450 with the DPS-500 Redundant External Power Supply

Alternate to the other Switches in the xStack® DGS-3400 Series, the DGS-3426P utilizes the DPS-600 as its External Redundant Power Supply. The DPS-600 is the ONLY RPS to be used with the DGS-3426P.



**NOTE:** See the DPS-500 or DPS-600 documentation for more information.



**CAUTION:** Do not use the Switch (except DGS-3426P) with any redundant power system other than the DPS-500.



## Section 3

# Connecting the Switch

*Switch to End Node*

*Switch to Switch*

*Connecting To Network Backbone or Server*



**NOTE:** All high-performance N-Way Ethernet ports can support both MDI-II and MDI-X connections.

## Switch to End Node

End nodes include PCs outfitted with a 10, 100 or 1000 Mbps RJ-45 Ethernet Network Interface Card (NIC) and routers.

An end node connects to the Switch via a twisted-pair UTP/STP cable. Connect the end node to any of the 1000BASE-T ports of the Switch.

The Link/Act LEDs for each UTP port will light green or amber when the link is valid. A blinking LED indicates packet activity on that port.

## Switch to Switch

There is a great deal of flexibility on how connections are made using the appropriate cabling.

- Connect a 10BASE-T hub or switch to the Switch via a twisted-pair Category 3, 4 or 5 UTP/STP cable.
- Connect a 100BASE-TX hub or switch to the Switch via a twisted-pair Category 5 UTP/STP cable.
- Connect 1000BASE-T switch to the Switch via a twisted pair Category 5e UTP/STP cable.
- Connect 10G optional module ports at the rear of the device using CX4 or fiber-optic cables
- Connect switch supporting a fiber-optic uplink to the Switch's SFP ports via fiber-optic cabling. See cabling guidelines in Appendix B for more information.

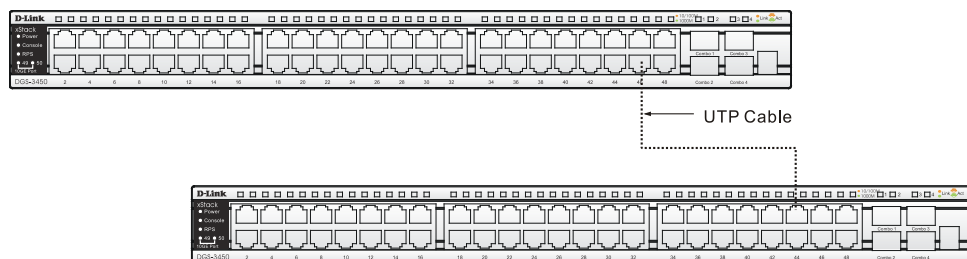

**Figure 3 - 1 Connect the Switch to a port on a switch with straight or crossover cable**

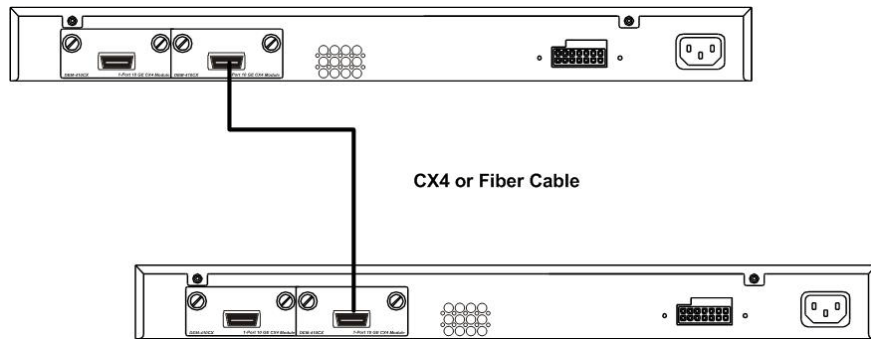
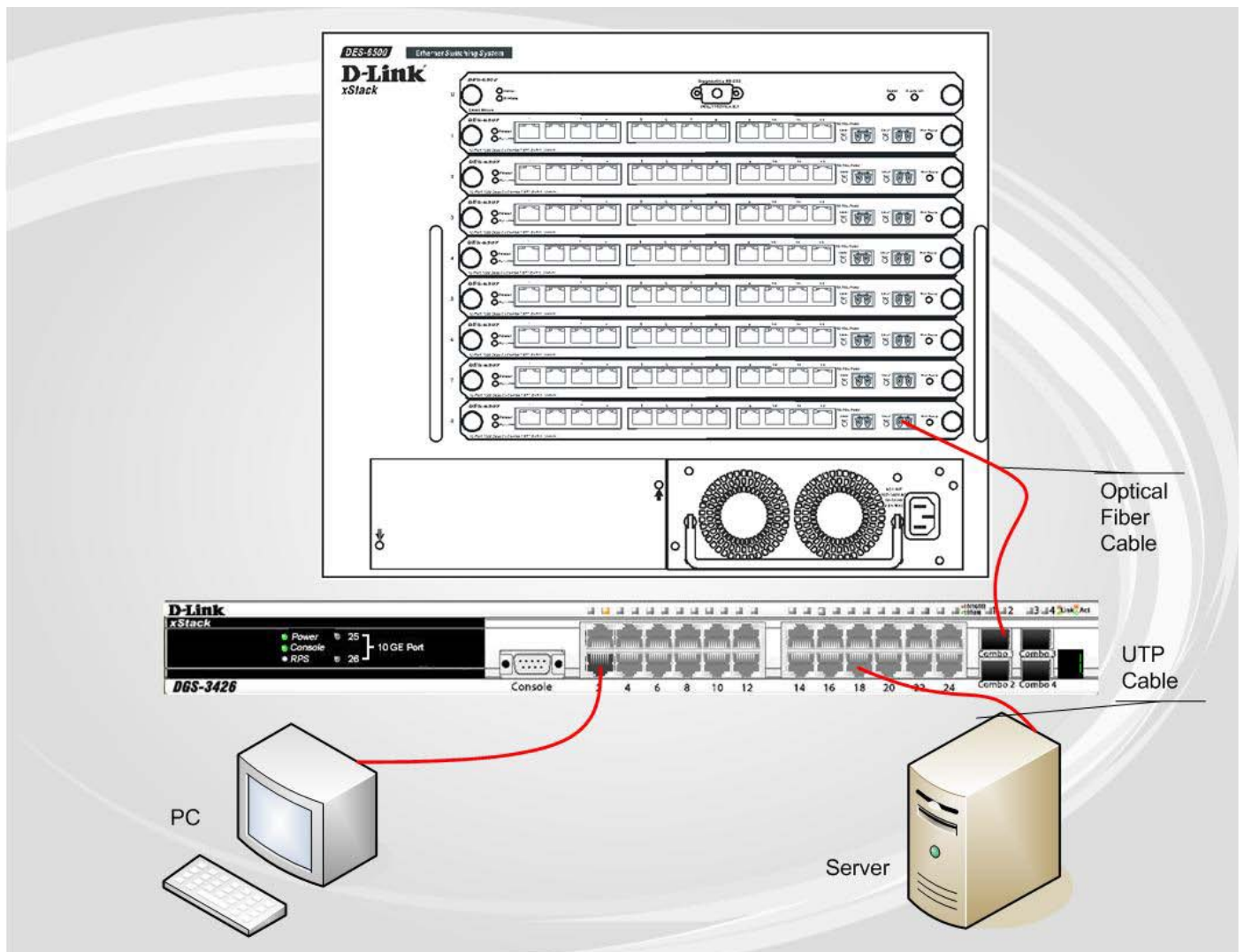

**Figure 3 - 2 Connect the Switch utilizing the 10G optional modules at the rear of the Switch.**

## Connecting To Network Backbone or Server

The combo SFP ports and the 1000BASE-T ports are ideal for uplinking to a network backbone, server or server farm. The copper ports operate at a speed of 1000, 100 or 10Mbps in full or half duplex mode. The fiber-optic ports can operate at 1000Mbps in full duplex mode only.

Connections to the Gigabit Ethernet ports are made using a fiber-optic cable or Category 5e copper cable, depending on the type of port. A valid connection is indicated when the Link LED is lit.



**Figure 3 - 3 DGS-3400 uplink connection to a server or switch stack, and downlink connection to a PC**

# **Introduction to Switch Management**

## ***Management Options***

***Connecting the Console Port (RS-232 DCE)***

***Managing the Switch for the First Time***

***Password Protection***

***SNMP Settings***

***IP Address Assignment***

## **Management Options**

This system may be managed out-of-band through the console port on the front panel or in-band using Telnet. The user may also choose the web-based management, accessible through a web browser.

### ***1. Web-based Management Interface***

After successfully installing the Switch, the user can configure the Switch, monitor the LED panel, and display statistics graphically using a web browser, such as Netscape Navigator (version 6.2 and higher) or Microsoft® Internet Explorer (version 5.0 and higher).

### ***2. SNMP-Based Management***

The Switch can be managed with an SNMP-compatible console program. The Switch supports SNMP version 1.0, version 2.0 and version 3.0. The SNMP agent decodes the incoming SNMP messages and responds to requests with MIB objects stored in the database. The SNMP agent updates the MIB objects to generate statistics and counters.

### ***3. Command Line Console Interface through the Serial Port***

The user can also connect a computer or terminal to the serial console port to access the Switch. The command-line-driven interface provides complete access to all Switch management features.

## Connecting the Console Port (RS-232 DCE)

The Switch provides an RS-232 serial port that enables a connection to a computer or terminal for monitoring and configuring the Switch. This port is a female DB-9 connector, implemented as a data terminal equipment (DTE) connection.

To use the console port, the following equipment is needed:

- A terminal or a computer with both a serial port and the ability to emulate a terminal.
- A null modem or crossover RS-232 cable with a female DB-9 connector for the console port on the Switch.

### *To connect a terminal to the console port:*

Connect the female connector of the RS-232 cable directly to the console port on the Switch, and tighten the captive retaining screws.

Connect the other end of the cable to a terminal or to the serial connector of a computer running terminal emulation software. Set the terminal emulation software as follows:

- Select the appropriate serial port (**COM port 1** or **COM port 2**).
- Set the data rate to **115200 baud**.
- Set the data format to **8 data bits, 1 stop bit, and no parity**.
- Set **flow control** to **none**.
- Under Properties, select **VT100** for Emulation mode.
- Select **Terminal** keys for **Function**, **Arrow** and **Ctrl** keys. Make sure to use Terminal keys (not Windows keys) are selected.



**NOTE:** When using HyperTerminal with the Microsoft® Windows® 2000 operating system, ensure that Windows 2000 Service Pack 2 or later is installed. Windows 2000 Service Pack 2 allows use of arrow keys in HyperTerminal's VT100 emulation. See [www.microsoft.com](http://www.microsoft.com) for information on Windows 2000 service packs.

- After you have correctly set up the terminal, plug the power cable into the power receptacle on the back of the Switch. The boot sequence appears in the terminal.
- After the boot sequence completes, the console login screen displays.
- If the user has not logged into the command line interface (CLI) program, press the Enter key at the User name and password prompts. There is no default user name and password for the Switch. The administrator must first create user names and passwords. If user accounts have been previously set up, log in and continue to configure the Switch.
- Enter the commands to complete desired tasks. Many commands require administrator-level access privileges. Read the next section for more information on setting up user accounts. See the *xStack® DGS-3400 Series CLI Manual* on the documentation CD for a list of all commands and additional information on using the CLI.
- To end a management session, use the logout command or close the emulator program.

If problems occur in making this connection on a PC, make sure the emulation is set to VT-100. The emulation settings can be configured by clicking on the **File** menu in the HyperTerminal window by clicking on **Properties** in the drop-down menu, and then clicking the **Settings** tab. This is where you will find the **Emulation** options. If you still do not see anything, try rebooting the Switch by disconnecting its power supply.

Once connected to the console, the screen below will appear on the console screen. This is where the user will enter commands to perform all the available management functions. The Switch will prompt the user to enter a user name and a password. Upon the initial connection, there is no user name or password and therefore just press enter twice to access the command line interface.

```
DGS-3450 Gigabit Ethernet Switch
Command Line Interface

Firmware: Build 2.70.B43
Copyright(C) 2010 D-Link Corporation. All rights reserved.
UserName:
```

**Figure 4 - 1 Initial Screen after first connection**

## Managing the Switch for the First Time

The Switch supports user-based security that can allow prevention of unauthorized users from accessing the Switch or changing its settings. This section tells how to log onto the Switch via out-of-band console connection.



**NOTE:** The passwords used to access the Switch are case-sensitive; for example, "S" is not the same as "s."



**NOTE:** Press Ctrl+R to refresh the screen. This command can be used at any time to force the console program in the Switch to refresh the console screen.

Press Enter in both the Username and Password fields. Then access will be given to enter commands after the command prompt **DGS-3426: admin#**, **DGS-3426P: admin#**, **DGS-3427: admin#** or **DGS-3450: admin#** as shown below:

```
DGS-3450 Gigabit Ethernet Switch
Command Line Interface

Firmware: Build 2.70.B43
Copyright(C) 2010 D-Link Corporation. All rights reserved.
UserName:
PassWord:

DGS-3450:admin#
```

**Figure 4 - 2 Initial screen, first time connecting to the Switch**

Press Enter in both the Username and Password fields. Then access will be given to enter commands after the command prompt **DGS-3426:admin#**, **DGS-3426P:admin#**, **DGS-3427:admin#** or **DGS-3450:admin#** as shown below:

There is no initial username or password. Leave the **Username** and **Password** fields blank.



**NOTE:** The first user automatically gets Administrator level privileges. At least one Admin-level user account must be created for the Switch.

## Password Protection

The xStack® DGS-3400 Series do not have a default user name and password. One of the first tasks when settings up the Switch is to create user accounts. Logging in using a predefined administrator-level user name will give the user privileged access to the Switch's management software.

After the initial login, define new passwords for both default user names to prevent unauthorized access to the Switch, and record the passwords for future reference.

To create an administrator-level account for the Switch, do the following:

1. At the CLI login prompt, enter `create account admin` followed by the `<user name>` and press the Enter key.
2. The Switch will then prompt the user to provide a password. Type the `<password>` used for the administrator account being created and press the Enter key.
3. Once entered, the Switch will again ask the user to enter the same password again to verify it. Type the same password and press the Enter key.
4. A "Success" response by the Switch will verify the creation of the new administrator.



**NOTE:** Passwords are case sensitive. User names and passwords can be up to 15 characters in length.

The sample below illustrates a successful creation of a new administrator-level account with the user name "newmanager".

```
DGS-3450:admin#create account admin newmanager
Command: create account admin newmanager

Enter a case-sensitive new password:***
Enter the new password again for confirmation:***
Success.

DGS-3450:admin#
```

**Figure 4 - 3 Creating an Account on the Switch**



**NOTICE:** CLI configuration commands only modify the running configuration file and are not saved when the Switch is rebooted. To save all configuration changes in non-volatile memory, use the `save` command to copy the running configuration file to the startup configuration.

## SNMP Settings

Simple Network Management Protocol (SNMP) is an OSI Layer 7 (Application Layer) designed specifically for managing and monitoring network devices. SNMP enables network management stations to read and modify the settings of gateways, routers, switches and other network devices. Use SNMP to configure system features for proper operation, monitor performance and detect potential problems in the Switch, switch group or network.

Managed devices that support SNMP include software (referred to as an agent), which runs locally on the device. A defined set of variables (managed objects) is maintained by the SNMP agent and used to manage the device. These objects are defined in a Management Information Base (MIB), which provides a standard presentation of the information controlled by the on-board SNMP agent. SNMP defines both the format of the MIB specifications and the protocol used to access this information over the network.

The xStack® DGS-3400 Series support SNMP versions 1, 2c, and 3. The administrator may specify which version of SNMP to use to monitor and control the Switch. The three versions of SNMP vary in the level of security provided between the management station and the network device.

In SNMP v.1 and v.2, user authentication is accomplished using 'community strings', which function like passwords. The remote user SNMP application and the Switch SNMP must use the same community string. SNMP packets from any station that has not been authenticated are ignored (dropped).

The default community strings for the Switch used for SNMP v.1 and v.2 management access are:

- public – Allows authorized management stations to retrieve MIB objects.
- private – Allows authorized management stations to retrieve and modify MIB objects.

SNMP v.3 uses a more sophisticated authentication process that is separated into two parts. The first part is to maintain a list of users and their attributes that are allowed to act as SNMP managers. The second part describes what each user on that list can do as an SNMP manager.

The Switch allows groups of users to be listed and configured with a shared set of privileges. The SNMP version may also be set for a listed group of SNMP managers. Thus, a group of SNMP managers can be created to view read-only information or receive traps using SNMP v.1 while assigning a higher level of security to another group, granting read/write privileges using SNMP v.3.

Using SNMP v.3 individual users or groups of SNMP managers can be allowed to perform or be restricted from performing specific SNMP management functions. The functions allowed or restricted are defined using the Object Identifier (OID) associated with a specific MIB. An additional layer of security is available for SNMP v.3 in that SNMP messages may be encrypted. To read more about how to configure SNMP v.3 settings for the Switch read the section entitled Management.

## Traps

Traps are messages that alert network personnel of events that occur on the Switch. The events can be as serious as a reboot (someone accidentally turned OFF the Switch), or less serious like a port status change. The Switch generates traps and sends them to the trap recipient (or network manager). Typical traps include trap messages for Authentication Failure, Topology Change and Broadcast/Multicast Storm.

## MIBs

The Switch in the Management Information Base (MIB) stores management and counter information. The Switch uses the standard MIB-II Management Information Base module. Consequently, values for MIB objects can be retrieved from any SNMP-based network management software. In addition to the standard MIB-II, the Switch also supports its own proprietary enterprise MIB as an extended Management Information Base. The proprietary MIB may also be retrieved by specifying the MIB Object Identifier. MIB values can be either read-only or read-write.

## IP Address Assignment

An IP Address must be assigned to each switch, which is used for communication with an SNMP network manager or other TCP/IP application (for example BOOTP, TFTP). The Switch's default IP address is 10.90.90.90. The user may change the default Switch IP address to meet the specification of your networking address scheme.

The Switch is also assigned a unique MAC address by the factory. This MAC address cannot be changed, and can be found by entering the command "**show switch**" into the command line interface, as shown below.

```
DGS-3450:admin#show switch
Command: show switch

Device Type      : DGS-3450 Gigabit Ethernet Switch
MAC Address      : 00-1C-F0-C8-5A-0F
IP Address       : 10.90.90.90 (Manual)
VLAN Name        : default
Subnet Mask      : 255.0.0.0
Default Gateway  : 0.0.0.0
Boot PROM Version : Build 1.00-B13
Firmware Version : Build 2.70.B43
Hardware Version  : A2
System Name      :
System Location   :
System Contact    :
Spanning Tree    : Disabled
GVRP             : Disabled
IGMP Snooping    : Disabled
MLD Snooping     : Disabled
RIP              : Disabled
RIPng            : Disabled
TELNET           : Enabled (TCP 23)
WEB              : Enabled (TCP 80)
SNMP             : Disabled
RMON             : Disabled
CTRL+C ESC q Quit SPACE n Next Page ENTER Next Entry a All
```

**Figure 4 - 4 “show switch” command**

The Switch's MAC address also appears in **Switch Information** menu of the web-based management interface. The IP address for the Switch must be set before it can be managed with the Web-based or SNMP manager, Telnet or SSH. The Switch IP address can be automatically set using BOOTP or DHCP protocols, in which case the actual address assigned to the Switch must be known. The IP address may be set using the Command Line Interface (CLI) over the console serial port as follows:

Starting at the command line prompt, enter the command:

```
config ipif System ipaddress xxx.xxx.xxx.xxx/yyy.yyy.yyy.yyy
```

Where the x's represent the IP address to be assigned to the IP interface named System and the y's represent the corresponding subnet mask. Alternatively, the user can enter **config ipif System ipaddress xxx.xxx.xxx.xxx/z**. Where the x's represent the IP address to be assigned to the IP interface named System and the z represents the corresponding number of subnets in CIDR notation. The IP interface named System on the Switch can be assigned an IP address and subnet mask, which can then be used to connect a management station to the Switch's Telnet or Web-based management agent.



```
DGS-3450:admin#config ipif System ipaddress 10.73.21.10/255.0.0.0
Command: config ipif System ipaddress 10.73.21.10/8

Success.

DGS-3450:admin#
```

**Figure 4 - 5 Assigning the Switch an IP Address**

In the above example, the Switch was assigned an IP address of 10.53.13.26 with a subnet mask of 255.0.0.0. The system message **Success** indicates that the command was executed successfully. The Switch can now be configured and managed via Telnet and the CLI or via the Web-based management.



**NOTE:** The DGS-3400 Series have the capability to be configured for an IP address of 0.0.0.0, or, in essence, have no IP address. This function may be used to disable Layer 3 functions of the Switch. When the IP address is set to 0.0.0.0 (invalid IP address), the Switch can only be managed through the console port or SIM. Other management applications such as Telnet, Web-based and SNMP cannot be used to manage the Switch when its IP address is 0.0.0.0.

# **Web-based Switch Configuration**

*Introduction*

*Logging on to the Web Manager*

*Web-Based User Interface*

*Web Pages*

## **Introduction**

All software functions of the xStack® DGS-3400 Series can be managed, configured and monitored via the embedded web-based (HTML) interface. Manage the Switch from remote stations anywhere on the network through a standard browser. The browser acts as a universal access tool and can communicate directly with the Switch using the HTTP protocol.

The Web-based management module and the Console program (and Telnet) are different ways to access the same internal switching software and configure it. Thus, all settings encountered in web-based management are the same as those found in the console program.

## Logging in to the Web Manager

To begin managing the Switch, simply run the browser installed on your computer and point it to the IP address you have defined for the device. The URL in the address bar should read something like: `http://123.123.123.123`, where the numbers 123 represent the IP address of the Switch.



**NOTE:** The factory default IP address is 10.90.90.90.

This opens the management module's user authentication window, as seen below.

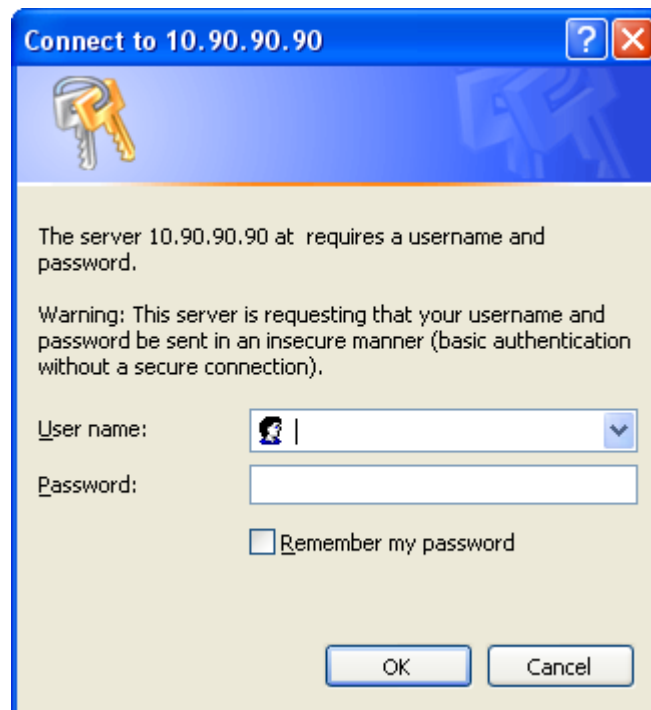

**Figure 5 - 1 Enter Network Password window**

Leave both the **User Name** field and the **Password** field blank and click **OK**. This will open the Web-based user interface. The Switch management features available in the web-based manager are explained below.

## Web-based User Interface

The user interface provides access to various Switch configuration and management screens, allows the user to view performance statistics, and permits graphical monitoring of the system status.

### Areas of the User Interface

The figure below shows the user interface. Three distinct areas divide the user interface, as described in the table.

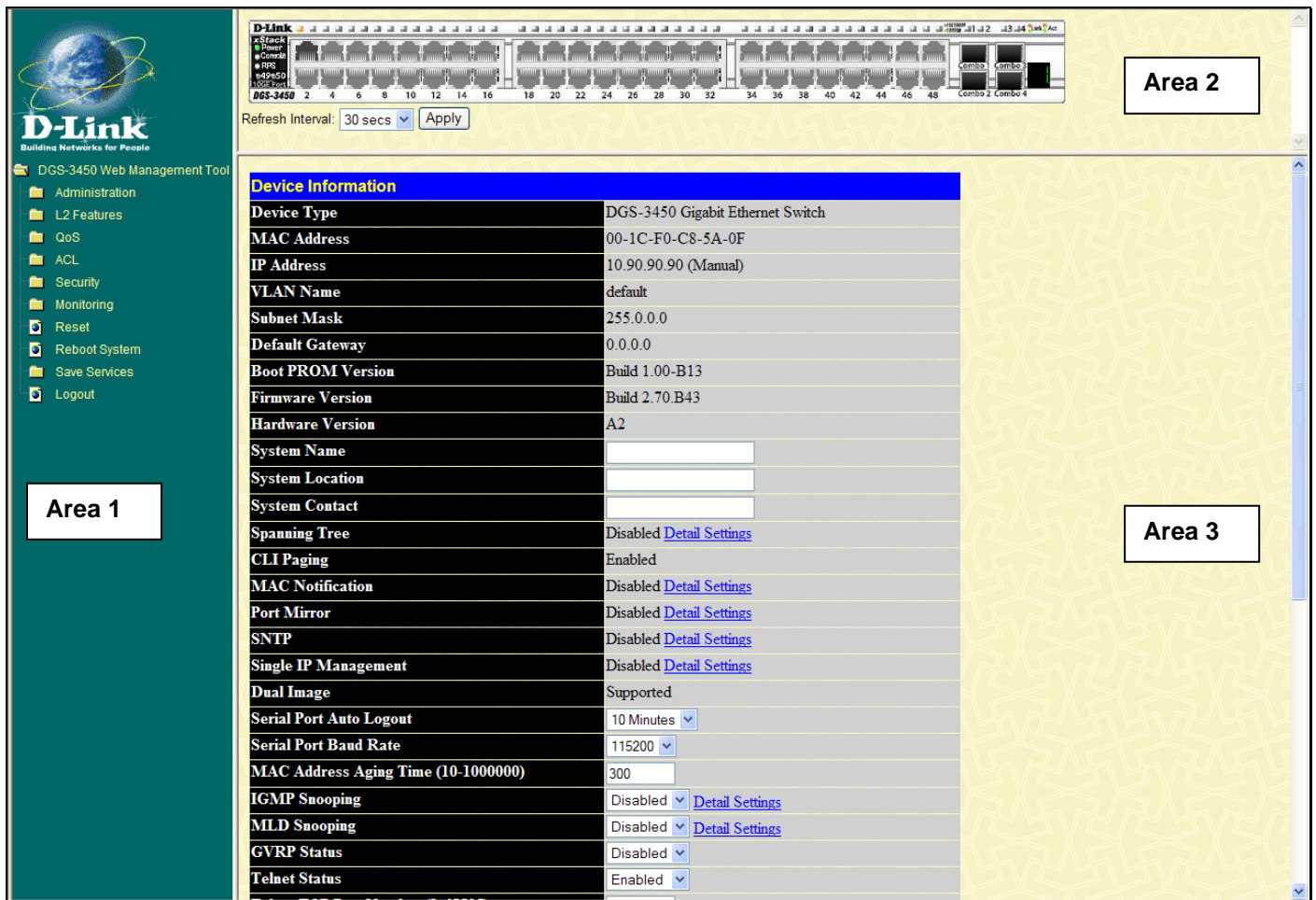

Figure 5 - 2 Main Web-Manager Screen

Area	Function
Area 1	Select the menu or window to display. Open folders and click the hyperlinked menu buttons and subfolders contained within them to display menus. Click the D-Link logo to go to the D-Link website.
Area 2	Presents a graphical near real-time image of the front panel of the Switch. This area displays the Switch's ports and expansion modules, showing port activity, duplex mode, or flow control, depending on the specified mode.  Some management functions, including port configuration are accessible here.
Area 3	Presents switch information based on user selection and the entry of configuration data.

## Web Pages

When connecting to the management mode of the Switch with a web browser, a login screen is displayed. Enter a user name and password to access the Switch's management mode.

Below is a list of the main folders available in the web interface:

**Administration** – Contains the following menu pages and sub-directories: IP Address, Interface Settings, Stacking, Port Configuration, User Accounts, Password Encryption, Mirror, System Log, System Severity Settings, Command Logging Settings, SNMP Settings, MAC Notification Settings, TFTP Services, Multiple Image Services, RCP, Ping Test, IPv6 Neighbor, Route Redistribution Settings, Static/Default Route Settings, Route Preference Settings, Gratuitous ARP Settings, Static ARP Settings, DHCP Auto Configuration Settings, DHCP/BOOTP Relay, DHCP/BOOTP Local Relay Settings, DHCPv6 Relay, DHCP Server, DHCPv6 Server, Filter DHCP Server, Layer 2 Protocol Tunneling Settings, RSPAN, DNS Relay, DNS Resolver, SNMP Manager, Trap Source Interface Settings, PoE (DGS-3426P only), sFlow, IP Multicast VLAN Replication, Single IP Management Settings, RIP, and IP Tunnel Settings.

**L2 Features** – Contains the following menu pages and sub-directories: VLAN, Trunking, IGMP Snooping, MLD Snooping, Loopback Detection Global Settings, Spanning Tree, Forwarding & Filtering, LLDP, Q-in-Q, ERPS, DULD Settings, and NLB Multicast FDB Settings.

**QoS** – Contains the following menu pages and sub-directories: 802.1p Settings, Bandwidth Control, HOL Prevention Settings, and Schedule Settings.

**ACL** – Contains the following menu pages and sub-directories: Time Range, Access Profile Table, ACL Flow Meter and CPU Interface Filtering.

**Security** – Contains the following menu pages and sub-directories: Authorization Network State Settings, Traffic Control, Port Security, IP-MAC-Port Binding, 802.1X, Web-based Access Control (WAC), Trust Host, BPDU Attach Protection Settings, ARP Spoofing Prevention Settings, Access Authentication Control, MAC-based Access Control, Safeguard Engine, Traffic Segmentation, SSL, SSH, Common Authentication, and Japanese Web-based Access Control (JWAC).

**Monitoring** – Contains the following menu pages and sub-directories: Device Status, Stacking Information (only when stacking mode is enabled), Stacking Device (only when stacking mode is enabled), Module Information, DRAM & FLASH Utilization, CPU Utilization, Port Utilization, Packets, Errors, Packet Size, Browse Router Port, Browse MLD Router Port, VLAN Status, VLAN Status Port, Port Access Control, MAC Address Table, IGMP Snooping Group, IGMP Snooping Data Driven Group, MLD Snooping Group, MLD Snooping Data Driven Group, Trace Route, Switch Logs, Browse ARP Table, Session Table, IP Forwarding Table, Routing Table, and MAC-based Access Control Authentication Status.

**Save Services** – Contains the following menu pages and sub-directories: Save Changes, Configure Information, and Current Configuration Settings.

**Reset, Reboot System** and **Logout** menu links are displayed in the main directory.



**NOTE:** Be sure to configure the user name and password in the User Accounts menu before connecting the Switch to the greater network.

**Appendix A**

# Technical Specifications

Specifications listed here apply to all Switches in the DGS-3400 Series except where otherwise noted.

General	
<b>Standards</b>	IEEE 802.3 10BASE-T Ethernet IEEE 802.3u 100BASE-TX Fast Ethernet IEEE 802.3ab 1000BASE-T Gigabit Ethernet IEEE 802.3z 1000BASE-T (SFP “Mini GBIC”) IEEE 802.3ae (10G Optional Modules) IEEE 802.1D/w/s Spanning Tree (Rapid, Multiple) IEEE 802.1P/Q VLAN IEEE 802.1p Priority Queues IEEE 802.1v Protocol VLAN IEEE 802.1X Network Access Control IEEE 802.3 Nway auto-negotiation IEEE 802.3ad Link Aggregation Control IEEE 802.3x Full-duplex Flow Control IEEE 802.1u Fast Ethernet IEEE 802.3af Power-over-Ethernet
<b>Protocols</b>	CSMA/CD
<b>Data Transfer Rates:</b>	Half-duplex      Full-duplex
<b>Ethernet</b>	10 Mbps          20Mbps
<b>Fast Ethernet</b>	100Mbps          200Mbps
<b>Gigabit Ethernet</b>	1000Mbps          2000Mbps
<b>Fiber Optic</b>	SFP (Mini GBIC) Support IEEE 802.3z 1000BASE-LX (DEM-310GT transceiver) IEEE 802.3z 1000BASE-SX (DEM-311GT transceiver) IEEE 802.3z 1000BASE-SX (DEM-312GT2 transceiver) IEEE 802.3z 1000BASE-LH (DEM-314GT transceiver) IEEE 802.3z 1000BASE-ZX (DEM-315GT transceiver) WDM Single Mode Transceiver 10km (DEM-330T/R) WDM Single Mode Transceiver 40km (DEM-331T/R)
<b>Topology</b>	Duplex Ring, Duplex Chain
<b>Network Cables</b>	Cat.5 Enhanced for 1000BASE-T UTP Cat.5, Cat. 5 Enhanced for 100BASE-TX UTP Cat.3, 4, 5 for 10BASE-T EIA/TIA-568 100-ohm screened twisted-pair (STP)(100m)

<b>Physical and Environmental</b>											
<b>Internal Power Supply Redundant Power Supply</b>	AC Input: 100 - 240 VAC, 50-60 Hz										
<b>Power Consumption</b>	<table border="1" style="width: 100%; border-collapse: collapse;"> <thead> <tr> <th style="text-align: left;"><b>DGS-3400 Series</b></th> <th style="text-align: left;"><b>Module Inserts</b></th> </tr> </thead> <tbody> <tr> <td>DGS-3426 (78.2 Watts)</td> <td>DEM-410CX (0.015 Watts)</td> </tr> <tr> <td>DGS-3426P (496 Watts)</td> <td>DEM-410X (6.16 Watts)</td> </tr> <tr> <td>DGS-3427 (86.68 Watts)</td> <td></td> </tr> <tr> <td>DGS-3450 (144.47 Watts)</td> <td></td> </tr> </tbody> </table>	<b>DGS-3400 Series</b>	<b>Module Inserts</b>	DGS-3426 (78.2 Watts)	DEM-410CX (0.015 Watts)	DGS-3426P (496 Watts)	DEM-410X (6.16 Watts)	DGS-3427 (86.68 Watts)		DGS-3450 (144.47 Watts)	
<b>DGS-3400 Series</b>	<b>Module Inserts</b>										
DGS-3426 (78.2 Watts)	DEM-410CX (0.015 Watts)										
DGS-3426P (496 Watts)	DEM-410X (6.16 Watts)										
DGS-3427 (86.68 Watts)											
DGS-3450 (144.47 Watts)											
<b>DC Fan:</b>	12v										
<b>Operating Temperature</b>	0 - 40°C										
<b>Storage Temperature</b>	-40 - 70°C										
<b>Humidity</b>	5 - 95% non-condensing										
<b>Dimensions</b>	441mm x 389mm x 44mm										
<b>Weight</b>	<table border="1" style="width: 100%; border-collapse: collapse;"> <thead> <tr> <th style="text-align: left;"><b>DGS-3400 Series</b></th> <th style="text-align: left;"><b>Module Inserts</b></th> </tr> </thead> <tbody> <tr> <td>DGS-3426 (5.42 kg)</td> <td>DEM-410CX (0.16 kg)</td> </tr> <tr> <td>DGS-3426P (6 kg)</td> <td>DEM-410X (0.18 kg)</td> </tr> <tr> <td>DGS-3427 (5.51 kg)</td> <td></td> </tr> <tr> <td>DGS-3450 (5.74 kg)</td> <td></td> </tr> </tbody> </table>	<b>DGS-3400 Series</b>	<b>Module Inserts</b>	DGS-3426 (5.42 kg)	DEM-410CX (0.16 kg)	DGS-3426P (6 kg)	DEM-410X (0.18 kg)	DGS-3427 (5.51 kg)		DGS-3450 (5.74 kg)	
<b>DGS-3400 Series</b>	<b>Module Inserts</b>										
DGS-3426 (5.42 kg)	DEM-410CX (0.16 kg)										
DGS-3426P (6 kg)	DEM-410X (0.18 kg)										
DGS-3427 (5.51 kg)											
DGS-3450 (5.74 kg)											
<b>EMI:</b>	CE class A, FCC Class A										
<b>Safety:</b>	CSA International, CB Report										

<b>Performance</b>	
<b>Transmission Method</b>	Store-and-forward
<b>Packet Buffer</b>	0.75 MB per device
<b>Packet Filtering / Forwarding Rate</b>	Full-wire speed for all connections 1,488,095 pps per port (for 1000Mbps)
<b>MAC Address Learning</b>	Automatic update. Supports 8K MAC address.
<b>Priority Queues</b>	8 Priority Queues per port.
<b>Forwarding Table Age Time</b>	Max age: 10-1000000 seconds. Default = 300.

## Appendix B

# Cables and Connectors

When connecting the Switch to another switch, a bridge or hub, a normal cable is necessary. Please review these products for matching cable pin assignment.

The following diagrams and tables show the standard RJ-45 receptacle/connector and their pin assignments.

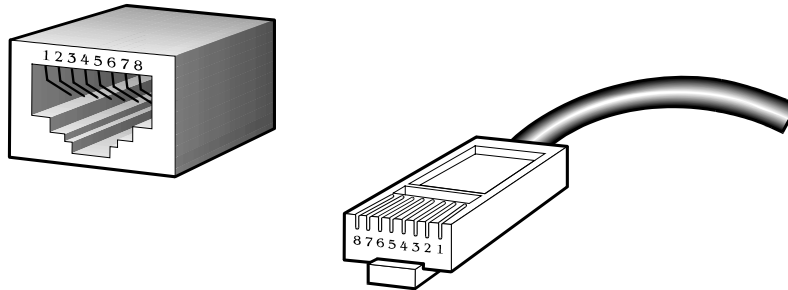

**Appendix B - 1 The standard RJ-45 port and connector**

RJ-45 Pin Assignments		
Contact	MDI-X Port	MDI-II Port
1	RD+ (receive)	TD+ (transmit)
2	RD- (receive)	TD- (transmit)
3	TD+ (transmit)	RD+ (receive)
4	1000BASE-T	1000BASE-T
5	1000BASE-T	1000BASE-T
6	TD- (transmit)	RD- (receive)
7	1000BASE-T	1000BASE-T
8	1000BASE-T	1000BASE-T

**Appendix B - 2 The standard RJ-45 pin assignments**



## Appendix C

# Cable Lengths

Use the following table to as a guide for the maximum cable lengths.

Standard	Media Type	Maximum Distance
Mini-GBIC	1000BASE-LX, Single-mode fiber module	10km
	1000BASE-SX, Multi-mode fiber module	550m / 2km
	1000BASE-LHX, Single-mode fiber module	40km
	1000BASE-ZX, Single-mode fiber module	80km
1000BASE-T	Category 5e UTP Cable	100m
	Category 5 UTP Cable (1000 Mbps)	
100BASE-TX	Category 5 UTP Cable (100 Mbps)	100m
10BASE-T	Category 3 UTP Cable (10 Mbps)	100m

# Glossary

**1000BASE-SX:** A short laser wavelength on multimode fiber optic cable for a maximum length of 550 meters

**1000BASE-LX:** A long wavelength for a "long haul" fiber optic cable for a maximum length of 10 kilometers

**100BASE-FX:** 100Mbps Ethernet implementation over fiber.

**100BASE-TX:** 100Mbps Ethernet implementation over Category 5 and Type 1 Twisted Pair cabling.

**10BASE-T:** The IEEE 802.3 specification for Ethernet over Unshielded Twisted Pair (UTP) cabling.

**ageing:** The automatic removal of dynamic entries from the Switch Database which have timed-out and are no longer valid.

**ATM:** Asynchronous Transfer Mode. A connection oriented transmission protocol based on fixed length cells (packets). ATM is designed to carry a complete range of user traffic, including voice, data and video signals.

**auto-negotiation:** A feature on a port which allows it to advertise its capabilities for speed, duplex and flow control. When connected to an end station that also supports auto-negotiation, the link can self-detect its optimum operating setup.

**backbone port:** A port which does not learn device addresses, and which receives all frames with an unknown address. Backbone ports are normally used to connect the Switch to the backbone of your network. Note that backbone ports were formerly known as designated downlink ports.

**backbone:** The part of a network used as the primary path for transporting traffic between network segments.

**bandwidth:** Information capacity, measured in bits per second, that a channel can transmit. The bandwidth of Ethernet is 10Mbps, the bandwidth of Fast Ethernet is 100Mbps.

**baud rate:** The switching speed of a line. Also known as line speed between network segments.

**BOOTP:** The BOOTP protocol allows automatic mapping of an IP address to a given MAC address each time a device is started. In addition, the protocol can assign the subnet mask and default gateway to a device.

**bridge:** A device that interconnects local or remote networks no matter what higher level protocols are involved. Bridges form a single logical network, centralizing network administration.

**broadcast:** A message sent to all destination devices on the network.

**broadcast storm:** Multiple simultaneous broadcasts that typically absorb available network bandwidth and can cause network failure.

**console port:** The port on the Switch accepting a terminal or modem connector. It changes the parallel arrangement of data within computers to the serial form used on data transmission links. This port is most often used for dedicated local management.

**CSMA/CD:** Channel access method used by Ethernet and IEEE 802.3 standards in which devices transmit only after finding the data channel clear for some period of time. When two devices transmit simultaneously, a collision occurs and the colliding devices delay their retransmissions for a random amount of time.

**data center switching:** The point of aggregation within a corporate network where a switch provides high-performance access to server farms, a high-speed backbone connection and a control point for network management and security.

**Ethernet:** A LAN specification developed jointly by Xerox, Intel and Digital Equipment Corporation. Ethernet networks operate at 10Mbps using CSMA/CD to run over cabling.

**Fast Ethernet:** 100Mbps technology based on the CSMA/CD network access method.

**Flow Control:** (IEEE 802.3X) A means of holding packets back at the transmit port of the connected end station. Prevents packet loss at a congested switch port.

**forwarding:** The process of sending a packet toward its destination by an internetworking device.

**full duplex:** A system that allows packets to be transmitted and received at the same time and, in effect, doubles the potential throughput of a link.

**half duplex:** A system that allows packets to be transmitted and received, but not at the same time. Contrast with full duplex.

**IP address:** Internet Protocol address. A unique identifier for a device attached to a network using TCP/IP. The address is written as four octets separated with full-stops (periods), and is made up of a network section, an optional subnet section and a host section.

**IPX:** Internetwork Packet Exchange. A protocol allowing communication in a NetWare network.

**LAN - Local Area Network:** A network of connected computing resources (such as PCs, printers, servers) covering a relatively small geographic area (usually not larger than a floor or building). Characterized by high data rates and low error rates.

**latency:** The delay between the time a device receives a packet and the time the packet is forwarded out of the destination port.

**line speed:** See baud rate.

**main port:** The port in a resilient link that carries data traffic in normal operating conditions.

**MDI - Medium Dependent Interface:** An Ethernet port connection where the transmitter of one device is connected to the receiver of another device.

**MDI-X - Medium Dependent Interface Cross-over:** An Ethernet port connection where the internal transmit and receive lines are crossed.

**MIB - Management Information Base:** Stores a device's management characteristics and parameters. MIBs are used by the Simple Network Management Protocol (SNMP) to contain attributes of their managed systems. The Switch contains its own internal MIB.

**multicast:** Single packets copied to a specific subset of network addresses. These addresses are specified in the destination-address field of the packet.

**protocol:** A set of rules for communication between devices on a network. The rules dictate format, timing, sequencing and error control.

**resilient link:** A pair of ports that can be configured so that one will take over data transmission should the other fail. See also main port and standby port.

**RJ-45:** Standard 8-wire connectors for IEEE 802.3 10BASE-T networks.

**RMON:** Remote Monitoring. A subset of SNMP MIB II that allows monitoring and management capabilities by addressing up to ten different groups of information.

**RPS - Redundant Power System:** A device that provides a backup source of power when connected to the Switch.

**server farm:** A cluster of servers in a centralized location serving a large user population.

**SLIP - Serial Line Internet Protocol:** A protocol which allows IP to run over a serial line connection.

**SNMP - Simple Network Management Protocol:** A protocol originally designed to be used in managing TCP/IP internets. SNMP is presently implemented on a wide range of computers and networking equipment and may be used to manage many aspects of network and end station operation.

**Spanning Tree Protocol (STP):** A bridge-based system for providing fault tolerance on networks. STP works by allowing the user to implement parallel paths for network traffic, and ensure that redundant paths are disabled when the main paths are operational and enabled if the main paths fail.

**STACK:** A group of network devices that are integrated to form a single logical device.

**standby port:** The port in a resilient link that will take over data transmission if the main port in the link fails.

**switch:** A device which filters, forwards and floods packets based on the packet's destination address. The switch learns the addresses associated with each switch port and builds tables based on this information to be used for the switching decision.

**TCP/IP:** A layered set of communications protocols providing Telnet terminal emulation, FTP file transfer, and other services for communication among a wide range of computer equipment.

**telnet:** A TCP/IP application protocol that provides virtual terminal service, letting a user log in to another computer system and access a host as if the user were connected directly to the host.

**TFTP - Trivial File Transfer Protocol:** Allows the user to transfer files (such as software upgrades) from a remote device using your switch's local management capabilities.

**UDP - User Datagram Protocol:** An Internet standard protocol that allows an application program on one device to send a datagram to an application program on another device.

**VLAN - Virtual LAN:** A group of location- and topology-independent devices that communicate as if they are on a common physical LAN.

**VLT - Virtual LAN Trunk:** A Switch-to-Switch link which carries traffic for all the VLANs on each Switch.

**VT100:** A type of terminal that uses ASCII characters. VT100 screens have a text-based appearance.

Subject to the terms and conditions set forth herein, D-Link Systems, Inc. ("D-Link") provides this lifetime product warranty for hardware:

- Only for products purchased, delivered and used within the fifty states of the United States, the District of Columbia, U.S. Possessions or Protectorates, U.S. Military Installations, or addresses with an APO or FPO, and;
- Only with proof of purchase.

**Product Warranty:** D-Link warrants that the hardware portion of the D-Link product, including internal and external power supplies and fans ("Hardware"), will be free from material defects in workmanship and materials under normal use from the date of original retail purchase of the product ("Warranty Period"), except as otherwise stated herein.

The customer's sole and exclusive remedy and the entire liability of D-Link and its suppliers under this Warranty will be, at D-Link's option, to repair or replace the defective Hardware during the Warranty Period at no charge to the owner or to refund the actual purchase price paid. Any repair or replacement will be rendered by D-Link at an Authorized D-Link Service Office. The replacement hardware need not be new or have an identical make, model or part. D-Link may, at its option, replace the defective Hardware or any part thereof with any reconditioned product that D-Link reasonably determines is substantially equivalent (or superior) in all material respects to the defective Hardware. Repaired or replacement hardware will be warranted for the remainder of the original Warranty Period or ninety (90) days, whichever is longer, and is subject to the same limitations and exclusions. If a material defect is incapable of correction, or if D-Link determines that it is not practical to repair or replace the defective Hardware, the actual price paid by the original purchaser for the defective Hardware will be refunded by D-Link upon return to D-Link of the defective Hardware. All Hardware or part thereof that is replaced by D-Link, or for which the purchase price is refunded, shall become the property of D-Link upon replacement or refund.

**Software Warranty:** D-Link warrants that the software portion of the product ("Software") will substantially conform to D-Link's then current functional specifications for the Software, as set forth in the applicable documentation, from the date of original retail purchase of the Software for a period of ninety (90) days ("Software Warranty Period"), provided that the Software is properly installed on approved hardware and operated as contemplated in its documentation. D-Link further warrants that, during the Software Warranty Period, the magnetic media on which D-Link delivers the Software will be free of physical defects. The customer's sole and exclusive remedy and the entire liability of D-Link and its suppliers under this Limited Warranty will be, at D-Link's option, to replace the non-conforming Software (or defective media) with software that substantially conforms to D-Link's functional specifications for the Software or to refund the portion of the actual purchase price paid that is attributable to the Software. Except as otherwise agreed by D-Link in writing, the replacement Software is provided only to the original licensee, and is subject to the terms and conditions of the license granted by D-Link for the Software. Replacement Software will be warranted for the remainder of the original Warranty Period and is subject to the same limitations and exclusions. If a material non-conformance is incapable of correction, or if D-Link determines in its sole discretion that it is not practical to replace the non-conforming Software, the price paid by the original licensee for the non-conforming Software will be refunded by D-Link; provided that the non-conforming Software (and all copies thereof) is first returned to D-Link. The license granted respecting any Software for which a refund is given automatically terminates.

**Non-Applicability of Warranty:** The Warranty provided hereunder for D-Link's products will not be applied to and does not cover any products obtained through a special or unique pricing agreement, if such agreement provides for warranty terms different from those normally provided with the product or set forth herein, nor to any refurbished product and any product purchased through the inventory clearance or liquidation sale or other sales in which D-Link, the sellers, or the liquidators expressly disclaim their warranty obligation pertaining to the product and in that case, the product is being sold "As-Is" without any warranty whatsoever including, without limitation, the Warranty as described herein, notwithstanding anything stated herein to the contrary.

**Submitting A Claim:** The customer shall return the product to the original purchase point based on its return policy. In case the return policy period has expired and the product is within warranty, the customer shall submit a claim to D-Link as outlined below:

- The customer must submit with the product as part of the claim a written description of the Hardware defect or Software nonconformance in sufficient detail to allow D-Link to confirm the same, along with proof of purchase of the product (such as a copy of the dated purchase invoice for the product).
- The customer must obtain a Case ID Number from D-Link Technical Support by going to <https://support.dlink.com>, who will attempt to assist the customer in resolving any suspected defects with the product. If the product is considered defective, the customer must obtain a Return Material Authorization ("RMA") number by completing the RMA form and entering the assigned Case ID Number at <https://rma.dlink.com/>.
- After an RMA number is issued, the defective product must be packaged securely in the original or other suitable shipping package to ensure that it will not be damaged in transit, and the RMA number must be prominently marked on the outside of the package. Include any manuals or accessories in the shipping package.
- The customer is responsible for all in-bound shipping charges to D-Link. No Cash on Delivery ("COD") is allowed. Products sent COD will either be rejected by D-Link or become the property of D-Link. Products shall be fully insured by the customer and shipped to **D-Link Systems, Inc., 17595 Mt. Herrmann, Fountain Valley, CA 92708**. D-Link will not be held responsible for any packages that are lost in transit to D-Link. The repaired or replaced packages will be shipped to the customer via UPS Ground or any common carrier selected by D-Link. Return shipping charges shall be prepaid by D-Link if you use an address in the United States, otherwise we will ship the product to you freight collect. Expedited shipping is available upon request and provided shipping charges are prepaid by the customer.

D-Link may reject or return any product that is not packaged and shipped in strict compliance with the foregoing requirements, or for which an RMA number is not visible from the outside of the package. The product owner agrees to pay D-Link's reasonable handling and return shipping charges for any product that is not packaged and shipped in accordance with the foregoing requirements, or that is determined by D-Link not to be defective or non-conforming.

**What Is Not Covered:** The Warranty provided herein by D-Link does not cover: Products that, in D-Link's judgment, have been subjected to abuse, accident, alteration, modification, tampering, negligence, misuse, faulty installation, lack of reasonable care, repair or service in any way that is not contemplated in the documentation for the product, or if the model or serial number has been altered, tampered with, defaced or removed; Initial installation, installation and removal of the product for repair, and shipping costs; Operational adjustments covered in the operating manual for the product, and normal maintenance; Damage that occurs in shipment, due to act of God, failures due to power surge, and cosmetic damage; Any hardware, software, firmware or other products or services provided by anyone other than D-Link; and Products that have been purchased from inventory clearance or liquidation sales or other sales in which D-Link, the sellers, or the liquidators expressly disclaim their warranty obligation pertaining to the product. While necessary maintenance or repairs on your Product can be performed by any company, we recommend that you use only an Authorized D-Link Service Office. Improper or incorrectly performed maintenance or repair voids this Warranty.

**Disclaimer of Other Warranties:** EXCEPT AS SPECIFICALLY SET FORTH ABOVE OR AS REQUIRED BY LAW, THE PRODUCT IS PROVIDED "AS-IS" WITHOUT ANY WARRANTY OF ANY KIND WHATSOEVER INCLUDING, WITHOUT LIMITATION, ANY WARRANTY OF MERCHANTABILITY, FITNESS FOR A PARTICULAR PURPOSE AND NON-INFRINGEMENT. IF ANY IMPLIED WARRANTY CANNOT BE DISCLAIMED IN ANY TERRITORY WHERE A PRODUCT IS SOLD, THE DURATION OF SUCH IMPLIED WARRANTY SHALL BE LIMITED TO NINETY (90) DAYS. EXCEPT AS EXPRESSLY COVERED UNDER THE WARRANTY PROVIDED HEREIN, THE ENTIRE RISK AS TO THE QUALITY, SELECTION AND PERFORMANCE OF THE PRODUCT IS WITH THE PURCHASER OF THE PRODUCT.

**Limitation of Liability:** TO THE MAXIMUM EXTENT PERMITTED BY LAW, D-LINK IS NOT LIABLE UNDER ANY CONTRACT, NEGLIGENCE, STRICT LIABILITY OR OTHER LEGAL OR EQUITABLE THEORY FOR ANY LOSS OF USE OF THE PRODUCT, INCONVENIENCE OR DAMAGES OF ANY CHARACTER, WHETHER DIRECT, SPECIAL, INCIDENTAL OR CONSEQUENTIAL (INCLUDING, BUT NOT LIMITED TO, DAMAGES FOR LOSS OF GOODWILL, LOSS OF REVENUE OR PROFIT, WORK STOPPAGE, COMPUTER FAILURE OR MALFUNCTION, FAILURE OF OTHER EQUIPMENT OR COMPUTER PROGRAMS TO WHICH D-LINK'S PRODUCT IS CONNECTED WITH, LOSS OF INFORMATION OR DATA CONTAINED IN, STORED ON, OR INTEGRATED WITH ANY PRODUCT RETURNED TO D-LINK FOR WARRANTY SERVICE) RESULTING FROM THE USE OF THE PRODUCT, RELATING TO WARRANTY SERVICE, OR ARISING OUT OF ANY BREACH OF THIS WARRANTY, EVEN IF D-LINK HAS BEEN ADVISED OF THE POSSIBILITY OF SUCH DAMAGES. THE SOLE REMEDY FOR A BREACH OF THE FOREGOING WARRANTY IS REPAIR, REPLACEMENT OR REFUND OF THE DEFECTIVE OR NON-CONFORMING PRODUCT. THE MAXIMUM LIABILITY OF D-LINK UNDER THIS WARRANTY IS LIMITED TO THE PURCHASE PRICE OF THE PRODUCT COVERED BY THE WARRANTY. THE FOREGOING EXPRESS WRITTEN WARRANTIES AND REMEDIES ARE EXCLUSIVE AND ARE IN LIEU OF ANY OTHER WARRANTIES OR REMEDIES, EXPRESS, IMPLIED OR STATUTORY.

**Lifetime Warranty:** IF LOCAL LAW MANDATES THE USE OF A DEFINITION OF "LIFETIME WARRANTY" DIFFERENT FROM THAT PROVIDED HEREIN, THEN THE LOCAL LAW DEFINITION WILL SUPERSEDE AND TAKE PRECEDENCE, TO THE EXTENT NECESSARY TO COMPLY.

**Governing Law:** This Warranty shall be governed by the laws of the State of California. Some states do not allow exclusion or limitation of incidental or consequential damages, or limitations on how long an implied warranty lasts, so the foregoing limitations and exclusions may not apply. This Warranty provides specific legal rights and you may also have other rights which vary from state to state.

**Trademarks:** D-Link is a registered trademark of D-Link Systems, Inc. Other trademarks or registered trademarks are the property of their respective owners.

**Copyright Statement:** No part of this publication or documentation accompanying this product may be reproduced in any form or by any means or used to make any derivative such as translation, transformation, or adaptation without permission from D-Link Corporation/D-Link Systems, Inc., as stipulated by the United States Copyright Act of 1976 and any amendments thereto. Contents are subject to change without prior notice. Copyright 2009 by D-Link Corporation/D-Link Systems, Inc. All rights reserved.

**CE Mark Warning:** This is a Class A product. In a residential environment, this product may cause radio interference, in which case the user may be required to take adequate measures.

**FCC Statement:** This equipment has been tested and found to comply with the limits for a Class A digital device, pursuant to part 15 of the FCC Rules. These limits are designed to provide reasonable protection against harmful interference in a commercial installation. This equipment generates, uses, and can radiate radio frequency energy and, if not installed and used in accordance with the instructions, may cause harmful interference to radio communication. However, there is no guarantee that interference will not occur in a particular installation. Operation of this equipment in a residential environment is likely to cause harmful interference to radio or television reception. If this equipment does cause harmful interference to radio or television reception, which can be determined by turning the equipment off and on, the user is encouraged to try to correct the interference by one or more of the following measures:

- Reorient or relocate the receiving antenna.
- Increase the separation between the equipment and receiver.
- Connect the equipment into an outlet on a circuit different from that to which the receiver is connected.
- Consult the dealer or an experienced radio/TV technician for help.

**For detailed warranty information applicable to products purchased outside the United States, please contact the corresponding local D-Link office.**

## *Product Registration*

*Register your D-Link product online at <http://support.dlink.com/register/>  
Product registration is entirely voluntary and failure to complete or return this form will not diminish your warranty rights.*

# Tech Support

## Technical Support

You can find software updates and user documentation on the D-Link website.

D-Link provides free technical support for customers within the United States and within Canada for the duration of the service period, and warranty confirmation service, during the warranty period on this product. U.S. and Canadian customers can contact D-Link technical support through our website, or by phone.

### Tech Support for customers within the United States:

***D-Link Technical Support over the Telephone:***

USA - 877-DLINK-55 (877-354-6555)

***D-Link Technical Support over the Internet:***

<http://support.dlink.com>

### Tech Support for customers within Canada:

***D-Link Technical Support over the Telephone:***

877-354-6560

***D-Link Technical Support over the Internet:***

<http://support.dlink.com>

**D-Link<sup>®</sup>**  
Building Networks for People

## Technical Support

### United Kingdom (Mon-Fri)

Home Wireless/Broadband 0871 873 3000 (9.00am–06.00pm, Sat 10.00am-02.00pm)  
Managed, Smart, & Wireless Switches, or Firewalls 0871 873 0909 (09.00am – 05.30pm)  
(BT 10ppm, other carriers may vary.)

### Ireland (Mon-Fri)

All Products 1890 886 899 (09.00am-06.00pm, Sat 10.00am-02.00pm)  
€ 0.05ppm peak, €0.045ppm off peak Times

### Internet

<http://www.dlink.co.uk>

<ftp://ftp.dlink.co.uk>

## Technische Unterstützung

Deutschland:	Web:	<a href="http://www.dlink.de">http://www.dlink.de</a>
	Telefon:	+49(0)1805 2787 0,14 € pro Minute
	Zeiten:	Mo. –Fr. 08:30 – 17:30 Uhr
Österreich:	Web:	<a href="http://www.dlink.at">http://www.dlink.at</a>
	Telefon:	+43(0)820 480084 0,116 € pro Minute
	Zeiten:	Mo. –Fr. 08:30 – 17:30 Uhr
Schweiz:	Web:	<a href="http://www.dlink.ch">http://www.dlink.ch</a>
	Telefon:	+41(0)848 331100 0,08 CHF pro Minute
	Zeiten:	Mo. –Fr. 08:30 – 17:30 Uhr

\* Gebühren aus Mobilnetzen und von anderen Providern können abweichen.



## Assistance technique

Assistance technique D-Link sur internet : <http://www.dlink.fr>

Assistance technique D-Link par téléphone : 0820 0803 03

0.12 € TTC/min depuis un poste fixe

Du lundi au vendredi de 9h à 19h (hors jours fériés)

## Asistencia Técnica

Asistencia Técnica Telefónica de D-Link: +34 902 30 45 45

0,067 €/min

De Lunes a Viernes de 9:00 a 19:00

<http://www.dlink.es>

## Supporto tecnico

Supporto Tecnico dal lunedì al venerdì dalle ore 9.00 alle ore 19.00 con orario continuato

Telefono: 199400057

<http://www.dlink.it/support>

## TECHNISCHE ONDERSTEUNING

Technische ondersteuning voor klanten in Nederland:

[www.dlink.nl](http://www.dlink.nl) / 0900 501 2007 / €0.15per minuut.

Tech Support for customers within Belgium:

[www.dlink.be](http://www.dlink.be) / 070 66 06 40 / €0.175per minuut(spitsuren), €0.0875per minuut(daluren)

Technische ondersteuning voor klanten in Luxemburg:

[www.dlink.be](http://www.dlink.be) / +32 70 66 06 40

## Pomoc techniczna

Telefoniczna pomoc techniczna firmy D-Link: 0 801 022 021

Pomoc techniczna firmy D-Link świadczona przez Internet:

<http://www.dlink.eu/support/>

## Technická podpora

Web: <http://www.dlink.cz/support/>

E-mail: [support@dlink.cz](mailto:support@dlink.cz)

Telefon: 225 281 553

Telefonická podpora je v provozu: PO – PÁ od 08:00 do 17:00

Pevná linka 1,78 Kč/min. –mobil 5,40 Kč/min.

## Technikai Támogatás

Tel. : 06 1 461-3001

Fax : 06 1 461-3004

Land Line 14,99 HUG/min - Mobile 49.99,HUF/min

email : [support@dlink.hu](mailto:support@dlink.hu)

URL : <http://www.dlink.hu>

## Teknisk Support

D-Link Teknisk Support over Internett: <http://www.dlink.no>

D-Link Teknisk telefon Support: 815 66 755

(Hverdager 08:00-17:00)

## Teknisk Support

D-Link teknisk support over telefonen: Tlf.: 9013 8899

Normale åbningstider: Hverdage kl. 08:00 - 20:00

D-Link teknisk support på Internettet: <http://www.dlink.dk>

## **Teknistä tukea asiakkaille Suomessa:**

Internetin kautta : <http://www.dlink.fi>

Arkisin klo. 9 - 18

numerosta : 0200 555 57

## **Teknisk Support**

D-Link Teknisk Support via Internet: <http://www.dlink.se>

D-Link Teknisk Support via telefon: 0770-3300 35

Vardagar 08:00-14:00

## **Assistência Técnica**

Assistência Técnica da D-Link na Internet:

<http://www.dlink.pt>

e-mail: [soporte@dlink.es](mailto:soporte@dlink.es)

## **Τεχνική Υποστήριξη**

D-Link Hellas Support Center

Κεφαλληνίας 64, 11251 Αθήνα,

Τηλ: 210 86 11 114 (Δευτέρα- Παρασκευή 09:00-17:00)

Φαξ: 210 8611114

<http://www.dlink.gr/support>

## **Tehnička podrška**

Hvala vam na odabiru D-Link proizvoda. Za dodatne informacije, podršku i upute za korištenje uređaja, molimo vas da posjetite D-Link internetsku stranicu na [www.dlink.eu](http://www.dlink.eu)  
[www.dlink.biz/hr](http://www.dlink.biz/hr)

## **Tehnična podpora**

Zahvaljujemo se vam, ker ste izbrali D-Link proizvod. Za vse nadaljnje informacije, podporo ter navodila za uporabo prosimo obiščite D-Link - ovo spletno stran [www.dlink.eu](http://www.dlink.eu)  
[www.dlink.biz/sl](http://www.dlink.biz/sl)

## **Suport tehnic**

Vă mulțumim pentru alegerea produselor D-Link. Pentru mai multe informații, suport și manuale ale produselor vă rugăm să vizitați site-ul D-Link [www.dlink.eu](http://www.dlink.eu)  
[www.dlink.ro](http://www.dlink.ro)

## Technical Support

You can find software updates and user documentation on the D-Link website.

### Tech Support for customers in

#### Australia:

Tel: 1300-766-868

24/7 Technical Support

Web: <http://www.dlink.com.au>

E-mail: [support@dlink.com.au](mailto:support@dlink.com.au)

#### India:

Tel: 1800-233-0000 (MTNL & BSNL Toll Free)

+91-832-2885700 (GSM, CDMA & Others)

Web: [www.dlink.co.in](http://www.dlink.co.in)

E-Mail: [helpdesk@dlink.co.in](mailto:helpdesk@dlink.co.in)

### Indonesia, Malaysia, Singapore and Thailand:

Tel: +62-21-5731610 (Indonesia)

Tel: 1800-882-880 (Malaysia)

Tel: +65 6501 4200 (Singapore)

Tel: +66-2-719-8978/9 (Thailand)

24/7, for English Support only

Web: <http://www.dlink.com.sg/support/>

E-mail: [support@dlink.com.sg](mailto:support@dlink.com.sg)

#### Korea:

Tel: +82-2-2028-1815

Monday to Friday 9:00am to 6:00pm

Web: <http://www.d-link.co.kr>

E-mail: [arthur@d-link.co.kr](mailto:arthur@d-link.co.kr)

#### New Zealand:

Tel: 0800-900-900

24/7 Technical Support

Web: <http://www.dlink.co.nz>

E-mail: [support@dlink.co.nz](mailto:support@dlink.co.nz)

**D-Link®**  
Building Networks for People

## Technical Support

You can find software updates and user documentation on the D-Link website.

### *Tech Support for customers in*

#### **Egypt:**

Tel: +202-2919035, +202-2919047  
Sunday to Thursday 9:00am to 5:00pm  
Web: <http://support.dlink-me.com>  
E-mail: [support.eg@dlink-me.com](mailto:support.eg@dlink-me.com)

#### **Iran:**

Tel: +98-21-88880918,19  
Saturday to Thursday 9:00am to 5:00pm  
Web: <http://support.dlink-me.com>  
E-mail: [support.ir@dlink-me.com](mailto:support.ir@dlink-me.com)  
[support@dlink.ir](mailto:support@dlink.ir)

#### **Israel:**

Magshimim 20, Petach Tikva 49348  
Main Tel: 972-3-9215173  
Customer Support Tel: 972-3-9212886  
Web: [www.dlink.co.il](http://www.dlink.co.il)

#### **Pakistan:**

Tel: +92-21-4548158  
+92-21-4548310  
Monday to Friday 10:00am to 6:00pm  
Web: <http://support.dlink-me.com>  
E-mail: [zkashif@dlink-me.com](mailto:zkashif@dlink-me.com)

#### **South Africa and Sub Sahara Region:**

Tel: +27-12-665-2165  
08600 DLINK (for South Africa only)  
Monday to Friday 8:30am to 9:00pm South Africa Time  
Web: <http://www.d-link.co.za>  
E-mail: [support@d-link.co.za](mailto:support@d-link.co.za)

#### **Turkey:**

Tel: +90-212-2895659  
Monday to Friday 9:00am to 6:00pm  
Web: <http://www.dlink.com.tr>  
E-mail: [turkiye@dlink-me.com](mailto:turkiye@dlink-me.com)

#### **U.A.E and North Africa:**

Tel: +971-4-4278127 (U.A.E)  
Sunday to Thursday 9.00AM to 6.00PM GMT+4  
Web: <http://www.dlink-me.com>  
E-mail: [support.me@dlink-me.com](mailto:support.me@dlink-me.com)

#### **Saudi ARABIA (KSA):**

Tel: +966 01 217 0008  
Fax: +966 01 217 0009  
Saturday to Wednesday 9.30AM to 6.30PM  
Thursdays 9.30AM to 2.00 PM  
E-mail: [Support.sa@dlink-me.com](mailto:Support.sa@dlink-me.com)

**D-Link®**  
Building Networks for People

## **Техническая поддержка**

Обновления программного обеспечения и документация доступны на Интернет-сайте D-Link.

D-Link предоставляет бесплатную поддержку для клиентов в течение гарантийного срока.

Клиенты могут обратиться в группу технической поддержки D-Link по телефону или через Интернет.

**Техническая поддержка D-Link:**  
+7(495) 744-00-99

**Техническая поддержка через Интернет**  
<http://www.dlink.ru>  
e-mail: [support@dlink.ru](mailto:support@dlink.ru)

**D-Link<sup>®</sup>**  
Building Networks for People

## SOPORTE TÉCNICO

Usted puede encontrar actualizaciones de softwares o firmwares y documentación para usuarios a través de nuestro sitio [www.dlinkla.com](http://www.dlinkla.com)

### SOPORTE TÉCNICO PARA USUARIOS EN LATINO AMERICA

Soporte técnico a través de los siguientes teléfonos de D-Link

PAIS	NUMERO
Argentina	0800 - 12235465
Chile	800 - 835465 ó (02) 5941520
Colombia	01800 - 9525465
Costa Rica	0800 - 0521478
Ecuador	1800 - 035465
El Salvador	800 - 6335
Guatemala	1800 - 8350255
México	01800 - 1233201
Panamá	011 008000525465
Perú	0800 - 00968
Venezuela	0800 - 1005767

### Soporte Técnico de D-Link a través de Internet

Horario de atención Soporte Técnico en [www.dlinkla.com](http://www.dlinkla.com)

e-mail: [soporte@dlinkla.com](mailto:soporte@dlinkla.com) & [consultas@dlinkla.com](mailto:consultas@dlinkla.com)

**D-Link®**  
Building Networks for People



## Suporte Técnico

Você pode encontrar atualizações de software e documentação de usuário no site da D-Link Brasil.

A D-Link fornece suporte técnico gratuito para clientes no Brasil durante o período de vigência da garantia deste produto.

### **Suporte Técnico para clientes no Brasil:**

Website para suporte: [www.dlink.com.br/suporte](http://www.dlink.com.br/suporte)  
e-mail: [suporte@dlink.com.br](mailto:suporte@dlink.com.br)

### **Telefones para contato:**

Clientes de São Paulo: 2755 6950  
Clientes das demais regiões: 0800 70 24 104  
Segunda à Sexta-feira, das 9:00h às 21:00h  
Sábado, das 9:00h às 15:00h

**D-Link**<sup>®</sup>  
Building Networks for People

## D-Link 友訊科技 台灣分公司 技術支援資訊

如果您還有任何本使用手冊無法協助您解決的產品相關問題，台灣地區用戶可以透過我們的網站、電子郵件或電話等方式與D-Link台灣地區技術支援工程師聯絡。

**D-Link 免付費技術諮詢專線**

0800-002-615

服務時間：週一至週五，早上9:00到晚上9:00

(不含周六、日及國定假日)

網 站：<http://www.dlink.com.tw>

電子郵件：[dssqa\\_service@dlink.com.tw](mailto:dssqa_service@dlink.com.tw)

如果您是台灣地區以外的用戶，請參考D-Link網站全球各地分公司的聯絡資訊以取得相關支援服務。

產品保固期限、台灣區維修據點查詢，請參考以下網頁說明：

<http://www.dlink.com.tw>

產品維修：

使用者可直接送至全省聯強直營維修站或請洽您的原購買經銷商。

**D-Link<sup>®</sup>**  
Building Networks for People

## **Dukungan Teknis**

Update perangkat lunak dan dokumentasi pengguna dapat diperoleh pada situs web D-Link.

### **Dukungan Teknis untuk pelanggan:**

#### **Dukungan Teknis D-Link melalui telepon:**

Tel: +62-21-5731610

#### **Dukungan Teknis D-Link melalui Internet:**

Email : [support@dlink.co.id](mailto:support@dlink.co.id)

Website : <http://support.dlink.co.id>

**D-Link<sup>®</sup>**  
Building Networks for People

## Technical Support

この度は弊社製品をお買い上げいただき、誠にありがとうございます。  
ございます。

下記弊社 Web サイトからユーザ登録及び新製品登録を  
行っていただくと、ダウンロードサービスにて  
サポート情報、ファームウェア、ユーザマニュアルを  
ダウンロードすることができます。

ディーリンクジャパン Web サイト

URL:<http://www.dlink-jp.com>

**D-Link**<sup>®</sup>  
Building Networks for People

## 技术支持

办公地址：北京市东城区北三环东路 36 号 环球贸易中心 B 座  
26F 02-05 室 邮编: 100013

技术支持中心电话：8008296688/ (028)66052968

技术支持中心传真：(028)85176948

各地维修中心地址请登陆官方网站查询

网址：<http://www.dlink.com.cn>

办公时间：周一到周五，早09:00到晚18:00

**D-Link**<sup>®</sup>  
Building Networks for People

# Registration Card

## All Countries and Regions Excluding USA

*Print, type or use block letters.*

Your name: Mr./Ms \_\_\_\_\_

Organization: \_\_\_\_\_ Dept. \_\_\_\_\_

Your title at organization: \_\_\_\_\_

Telephone: \_\_\_\_\_ Fax: \_\_\_\_\_

Organization's full address: \_\_\_\_\_

\_\_\_\_\_

Country: \_\_\_\_\_

Date of purchase (Month/Day/Year): \_\_\_\_\_

Product Model	Product Serial No.	* Product installed in type of computer	* Product installed in computer serial No.

(\* Applies to adapters only)

*Product was purchased from:*

Reseller's name: \_\_\_\_\_

Telephone: \_\_\_\_\_

**Answers to the following questions help us to support your product:**

**1. Where and how will the product primarily be used?**

Home Office Travel Company Business Home Business Personal Use

**2. How many employees work at installation site?**

1 employee 2-9 10-49 50-99 100-499 500-999 1000 or more

**3. What network protocol(s) does your organization use ?**

XNS/IPX TCP/IP DECnet Others \_\_\_\_\_

**4. What network operating system(s) does your organization use ?**

D-Link LANsmart Novell NetWare NetWare Lite SCO Unix/Xenix PC NFS 3Com 3+Open Cisco Network

Banyan Vines DECnet Pathwork Windows NT Windows 98 Windows 2000/ME Windows XP

Others \_\_\_\_\_

**5. What network management program does your organization use ?**

D-View HP OpenView/Windows HP OpenView/Unix SunNet Manager Novell NMS

NetView 6000 Others \_\_\_\_\_

**6. What network medium/media does your organization use ?**

Fiber-optics Thick coax Ethernet Thin coax Ethernet 10BASE-T UTP/STP

100BASE-TX 1000BASE-T Wireless 802.11b and 802.11g wireless 802.11a Others \_\_\_\_\_

**7. What applications are used on your network?**

Desktop publishing Spreadsheet Word processing CAD/CAM

Database management Accounting Others \_\_\_\_\_

**8. What category best describes your company?**

Aerospace Engineering Education Finance Hospital Legal Insurance/Real Estate Manufacturing

Retail/Chain store/Wholesale Government Transportation/Utilities/Communication VAR

System house/company Other \_\_\_\_\_

**9. Would you recommend your D-Link product to a friend?**

Yes No Don't know yet

**10. Your comments on this product?**

\_\_\_\_\_

\_\_\_\_\_

PLEASE  
PLACE STAMP  
HERE

**TO:**

---

---

---

**D-Link®**