

D-Link DPR-1040

Wireless G Multifunction Print Server

Manual

Rev. 04 (January, 2009)

D-Link[®]
Building Networks for People

Table of Contents

Package Contents	1
Contents of Package:	1
System Requirements:	1
Introduction.....	2
External Features	4
Rear Panel.....	4
USB Port.....	4
Ethernet Port (LAN)	5
DC Power Connector	5
Wi-Fi Protected Setup (WPS) Button	5
LED Indicators.....	6
Wireless Basics	8
Wireless Installation Considerations.....	10
Installing Considerations	10
WPS (Wi-Fi Protected Setup).....	12
Setting up the DPR-1040	13
Installing the Print Server	13
Wireless Setup.....	14
Getting Started	16
Using PS Software	17
Auto-Run Installation	17
Installing PS Software	18
Using PS-Link.....	20
Installing and Using MFP/GDI Printers	26
Using the Web Configurator	44

Table of Contents

HOME.....	44
SETUP > Print Server Setup.....	46
SETUP > LAN Setup.....	48
SETUP > Wireless Setup	49
SETUP > Printer Setup	51
ADVANCED > Advanced LAN.....	55
ADVANCED > User Access.....	56
MAINTENANCE > Password.....	58
MAINTENANCE > Save/Restore Settings.....	59
MAINTENANCE > Firmware Upgrade.....	60
MAINTENANCE > Diagnostics	61
STATUS > Device Info.....	62
STATUS > Network.....	64
STATUS > Wireless	65
HELP	66
Reboot.....	67
Refresh Printer Status	68
TCP/IP Printing for Windows Vista.....	69
TCP/IP Printing for Windows XP.....	77
TCP/IP Printing for Windows 2000	92
Setting up Printing in Mac OS X Tiger (10.4.9).....	105
Adding a Printer.....	105
To set up LPD Printing	107
Set up Socket Printing.....	108
Technical Specifications	111
Contacting Technical Support.....	112
Warranty and Registration	113

Table of Contents

Appendix: DPR-1040 Printer Compatibility List 120

Package Contents



Contents of Package:

- D-Link DPR-1040 USB 2.0 Wireless 11g MFP Server
- Manual and Warranty on CD
- Printed Quick Installation Guide

If any of the above items are missing, please contact your reseller.

System Requirements:

- A computer with Ethernet interface
- Windows Vista/XP/2000/NT4/ME/98SE
- MAC OS X 10.4.x
- Internet Explorer 6.0 or above; Netscape Navigator version 6.0 or above, with JavaScript enabled
- Your printer must support the required operating system

Introduction

D-Link's DPR-1040 Print Server allows you to connect a USB Multi-Function Printer (MFP) to your existing Ethernet network. This product lets multiple users print, scan and fax using the connected printer. The DPR-1040 also manages the flow of print files and delivers print jobs quickly and efficiently.

The DPR-1040 comes with easy to use software compatible with most Windows-based networks. Protocol support for TCP/IP, LPR, RAW, IPP is provided to ensure seamless connection to major networking operating systems.

The DPR-1040 has a built in web configurator that allows users to easily configure the Print Server and manage multiple print queues through TCP/IP.

The DPR-1040 improves upon network printing services in the following ways:

- The DPR-1040 manages the print file traffic for all of the connected printers. This provides relief for your file servers and allows them to be used to their full capacity for file access or other network services. On peer-to-peer networks, workstations can print directly to the Print Server without increasing the load of another workstation or server.
- The DPR-1040 Print Server is portable and cheap compared to a PC-based print server. This means you're able to deploy the DPR-1040 in locations that offer maximum convenience to users.
- Use the included PS-Link software to enable your computer to use your MFP printer's print/scan/fax/copy functions. **PS-Link** helps you to install your printer's

manufacturer drivers without creating a physical USB connection from your printer to your computer. After the software provided by your printer's manufacturer is installed, using the printer's scan and fax functions will be exactly the same as how it's described in your printer's manual.

The DPR-1040 is compatible with the following major network operating systems:

■ TCP/IP

UNIX lpr/lpd (HP-UX, SunOS, Solaris, SCO, UnixWare, IBM AIX) Windows NT/2000, Windows 98SE/ME, Windows XP/Vista, NetWare 5.x NDPS LPR Remote Printing

MacOS X (LPR/IPP protocols)

The PS software - PS Link, allows further configuration of the MFP server:

■ **PS-Link** —Use this to enable your computer to use your printer's print/scan/fax/copy functions and GDI printing. **PS-Link** helps you to install your printer's manufacturer drivers without creating a physical USB connection from your printer to your computer. For more information see the "Using The PS Software" Chapter.

External Features

Rear Panel



USB Port

The DPR-1040's USB printer port is located on the rear panel of the device and is configurable using the web configurator.

The default IP address of the DPR-1040 is automatically acquired from a DHCP server on the network. If a DHCP server cannot be found the default IP address for the DPR-1040 will be **192.168.0.10**.

NOTE: Your PC's IP Address must be in the same subnet as the Print Server's IP Address for the two devices to communicate. (For example, if MFP server's IP Address is 192.168.0.10, with a subnet mask of 255.255.255.0, then your computer's IP Address should be 192.168.0.x, where x is a value between 1-254,

excluding 10.)

Ethernet Port (LAN)

The Print Server's rear panel features an Ethernet port for connecting 10/100Mbps CAT 5 Ethernet cables. This port supports the NWay protocol, allowing the Print Server to automatically detect or negotiate the transmission speed of the network.

DC Power Connector

The DC power input connector is labeled DC 5V.

Wi-Fi Protected Setup (WPS) Button

Press this button to use WPS to connect to a wireless network. For more information about this button see **Section 5 - Wireless Setup**.



LED Indicators



The top of the Print Server features four LEDs:

■ **Power** 

A steady blue light confirms that the Print Server is turned ON.

■ **USB** 

A steady blue light indicates the printer is online and successfully connected to the print server. This light will also blink to indicate that data is being transferred between the print server and printer.

■ **Link/Act** 

A steady blue light confirms that the Print Server has a connection to an Ethernet network. This light will also blink when receiving or transmitting data on the network.

■ **WirelessLink/Act** 

A steady blue light confirms that the Print Server has a connection to a wireless network. This light will also blink when receiving or transmitting data on the network.

Wireless Basics

D-Link wireless products are based on industry standards to provide easy-to-use and compatible high-speed wireless connectivity within your home, business or public access wireless networks. D-Link wireless products allow you to access the data you want, when and where you want. You will be able to enjoy the freedom that wireless networking brings.

A wireless LAN (WLAN) is a cellular computer network that transmits and receives data with radio signals instead of wires. WLANs are used increasingly in both home and office environments, and public areas such as airports, coffee shops and universities. Innovative ways to utilize WLAN technology are helping people to work and communicate more efficiently. Increased mobility and the absence of cabling and other fixed infrastructure have proven to be beneficial for many users.

Wireless users can use the same applications they use on a wired network. Wireless adapter cards used on laptop and desktop systems support the same protocols as Ethernet adapter cards.

People use wireless LAN technology for many different purposes:

■ **Mobility**

Productivity increases when people have access to data in any location within the operating range of the WLAN. Management decisions based on real-time information can significantly improve worker efficiency.

■ **Low Implementation Costs**

WLANs are easy to set up, manage, change and relocate. Networks that frequently change can benefit from WLANs ease of implementation. WLANs can operate in locations where installation of wiring may be impractical.

■ **Installation and Network Expansion**

Installing a WLAN system can be fast and easy and can eliminate the need to pull cable through walls and ceilings. Wireless technology allows the network to go where wires cannot go – even outside the home or office.

■ **Scalability**

WLANs can be configured in a variety of topologies to meet the needs of specific applications and installations. Configurations are easily changed and range from peer-to-peer networks suitable for a small number of users to larger infrastructure networks to accommodate hundreds or thousands of users, depending on the number of wireless devices deployed.

■ **Inexpensive Solution**

Wireless network devices are as competitively priced as conventional Ethernet network devices.

■ **Standards-Based Technology**

Based on the IEEE 802.11g standard, the DPR-1040 is interoperable with existing compatible 2.4GHz wireless technology with data transfer speeds of up to 54Mbps□ when used with other D-Link devices.

■ **Maximum wireless signal rate based on IEEE Standard 802.11g specifications.**

Actual data throughput will vary. Network conditions and environmental factors, including volume of network traffic, building materials and construction, and network overhead lower actual data throughput rate.

Wireless Installation Considerations

Installing Considerations

The D-Link DPR-1040 lets you print through your network, using a wireless connection, from virtually anywhere within its operating range. Keep in mind, however, that the number, thickness and location of walls, ceilings, or other objects that the wireless signals must pass through, may limit the range. Typical ranges vary depending on the types of materials and background RF (radio frequency) noise in your home or business. The key to maximize wireless range is to follow these basic guidelines:

1. Keep the number of walls and ceilings between the DPR-1040 and other network devices to a minimum. Each wall or ceiling can reduce your D-Link wireless products range from 3-90 feet (1-30 meters). Position your devices so that the number of walls or ceilings is minimized.
2. Be aware of the direct line between network devices. A wall that is 1.5 feet thick (0.5 meters), at a 45-degree angle appears to be almost 3 feet (1meter) thick. At a 2-degree angle it looks over 42 feet (14 meters). Position devices so that the signal will travel straight through a wall or ceiling (instead of at an angle) for better reception.
3. Building materials can impede the wireless signal. A solid metal door or aluminum studs may have a negative effect on range. Try to position wireless devices and computers with wireless adapters so that the signal passes through drywall or open doorways and not other materials.

4. Keep your product away (at least 3-6 feet or 1-2 meters) from electrical devices or appliances that generate extreme RF noise.

WPS (Wi-Fi Protected Setup)

Wi-Fi Protected Setup (WPS) is a standard for easy and secure establishment of a wireless network. Traditionally, users would have to manually create a wireless network name (**SSID**), and then manually entering a creative, yet predictable security key on both the access point and client to prevent unexpected access to their wireless network.

This whole process requires the users to have the background knowledge of the Wi-Fi devices and the ability to make the necessary configuration changes. With WPS, it will automatically configure a wireless network with a network name (**SSID**) and strong WPA data encryption and authentication. WPS is designed to support various Wi-Fi certified 802.11 products including access points, wireless adapters, Wi-Fi phones, and any other consumer electronics devices.

For DPR-1040, WPS can be enabled by way of **PBC** (Push button configuration) method, in which users simply need to push a WPS button on both WPS devices to connect.

Setting up the DPR-1040

Installing the Print Server

WARNING: There may be configuration problems if the Print Server is turned on without first establishing a network connection.

Follow the steps below to avoid any complications during the hardware installation:

1. Confirm that the printer you will use to connect to the DPR-1040 is operating correctly.
2. When you have confirmed that the printer is operating correctly, switch its power OFF.
3. Confirm that your network is operating normally.
4. Using a CAT 5 Ethernet cable, connect the DPR-1040 Ethernet Port (labeled **LAN**) to the network.
5. While the printer is turned OFF, connect the USB printer cable to the printer and then to the USB port on the Print Server.
6. Switch on the printer.
7. Insert the power adapter's output plug into the DC 5V power socket on the rear panel of the Print Server.
8. Connect the other end of the power adapter into a power outlet. This will supply power to the Print Server. The blue LED on the Print Server's front panel should turn on.

Wireless Setup

WPS (Push Button Configuration)

WPS simplifies the process of connecting to a wireless network to a touch of a button. To use WPS you must have a WPS compatible wireless router, if you do not then you will need to manually configure the wireless connection in the web configurator (see Web Configurator below).

1. After following the hardware installation steps in section 3, ensure your wireless network is operating normally. When ready, press the WPS button located on the side of the DPR-1040. The blue LED should start flashing repeatedly.
2. Within 120 seconds, press the WPS button located on the wireless router you will be connecting to. This button may also be located in the router's web configuration pages labeled "Push Button Configuration (PBC)".
3. If successful, a wireless connection will be established between the two devices. This connection is secure and uses automatically generated encryption keys; you do not need to remember them.

Note: If you experience problems connecting to a device, please try again. If you still experience problems, the device you're connecting to may be incompatible with the DPR-1040. Also, make sure you are connecting to a router or access point (AP).

Web Configurator

1. After following the hardware installation steps in section 3, ensure your wireless network is operating normally. When ready, type the IP address of the DPR-1040 into your browser, the default IP address is **192.168.0.10**. If this does not work, use the PS-Link utility to find out the IP address.
2. Upon accessing the web configurator, click **Setup > Wireless Setup**.
3. On the next screen, enter the wireless network settings as provided by your network administrator.
4. Click **Apply Settings**, the DPR-1040 will restart and the wireless setup is complete.

Note: If your wireless connection does not work, check that you have entered the correct network settings into the **Wireless Setup** screen.

Getting Started

Below is a sample network using the DPR-1040. The DPR-1040 has a built-in Web-based management feature that allows users to easily configure and manage multiple print queues through TCP/IP.



WARNING: Only a USB printer may be connected to the USB port of the DPR-1040. Do not connect any other USB devices to the USB port of the DPR-1040; to do so, may damage the unit and will void the warranty for this product.

For a list of printers that are compatible with the DPR-1040, please see the Appendix in this manual. The compatibility list is not comprehensive. Even if it is not included in the list, your printer may be compatible with the DPR-1040.

Using PS Software

This chapter will introduce you to the installation and operation of the PS Software (**PS-Link**) with which the MFP Server can be configured further.

Auto-Run Installation

Insert the included installation CD into your computer's CD-ROM drive to initiate the auto-run program. If auto-run does not start, click **My Computer** > [**CD ROM Drive Letter**].

The content of the installation CD-ROM includes:

- **Install PS-Software** – click this to install the **PS Software**, this contains **PS-Link** which can configure more settings for the MFP Server, such as:
 - Change the IP address
 - Enabling the support of an MFP's multi-functions (Print/Scan/Copy/Fax), GDI printing, and other software from any MFP/GDI printer.
 - Easily add a printer to your computer.
- **View QIG** – click this to preview the *Quick Installation Guide* in PDF format for step-by-step instructions of the MFP Server Installation.
- **View Manual** – click this to preview the *User Manual* in PDF format for detailed information regarding the MFP Server.
- **Adobe Reader** – click this to install Acrobat Reader for the viewing and printing of PDF files found in this Installation CD-ROM.
- **Exit** – click to close the Auto-Run program.

PS Software

To avoid the conflict in your network, you can use **PS Software** to change the related settings of your MFP Server (such as the IP address) after finishing the installation of **PS Software** on your PC.

The **PS Software** contains one utility: **PS-Link**.

Installing PS Software

1. Click the **Install PS-Software** icon on the Installation CD-ROM menu.
2. Click the **Next >** button in the welcome window of **InstallShield Wizard**.

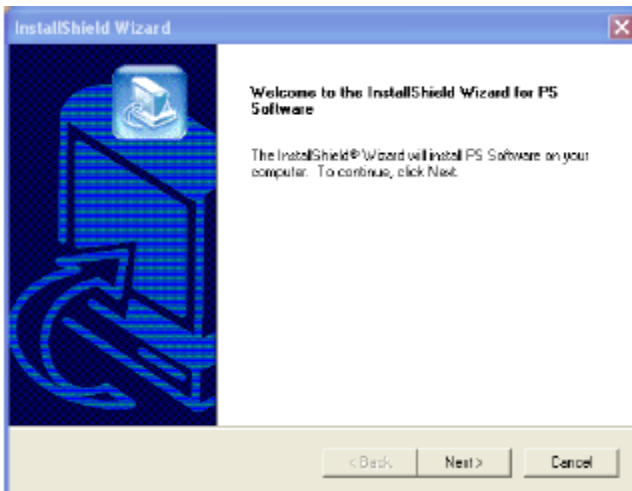

3. Specify the destination location by clicking the **Browse...** button. Otherwise, leave the default setting and click the **Next >** button to continue.

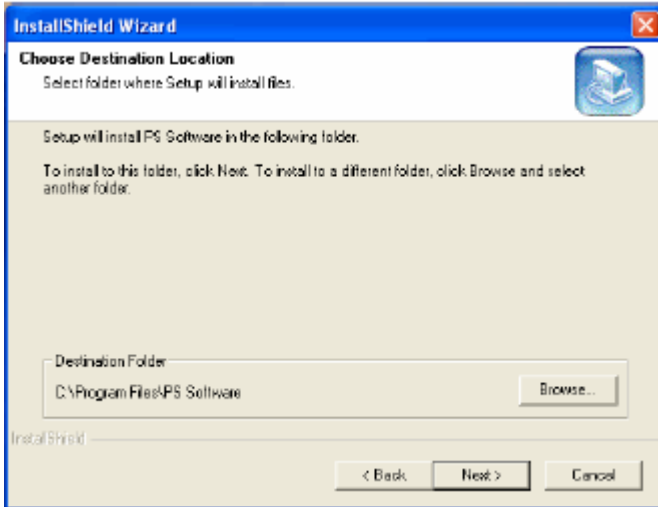

4. You may enter a new folder name in the Program Folder field if you want to change the default name. Otherwise click the **Next >** button to go to the next screen.

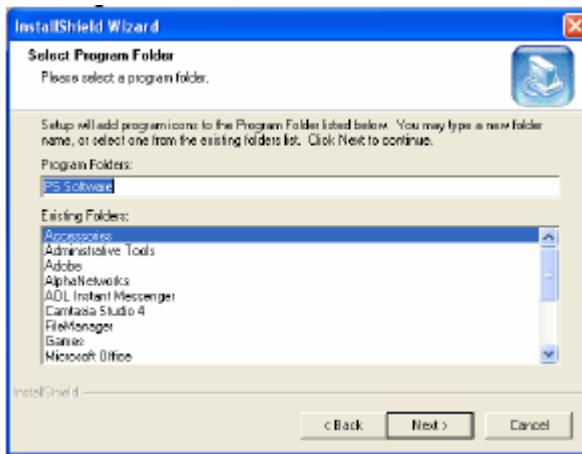

5. The **InstallShield Wizard** starts to install the software, and the Progress bar indicates the installation is proceeding until the following window shows up. Click the **Finish** button to complete the installation.

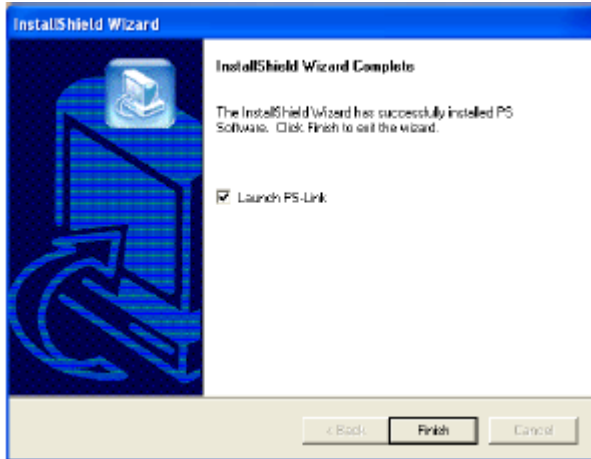

After installing the program, you can access the utilities by clicking **Start** → **Programs** → **PS Software** → **PS Link**.

Using PS-Link

PS-Link (Windows 2000/XP/2003/Vista), is a utility that will help you use your printer manufacturer drivers with the MFP print server. Using the **Link** command you can simulate a physical USB connection between your computer and printer, thus enabling you to complete the installation of the manufacturer drivers without making a USB connection to your computer.

To start PS-Link, go to **Start** → **Programs** → **PS Software**, and click **PS-Link**.

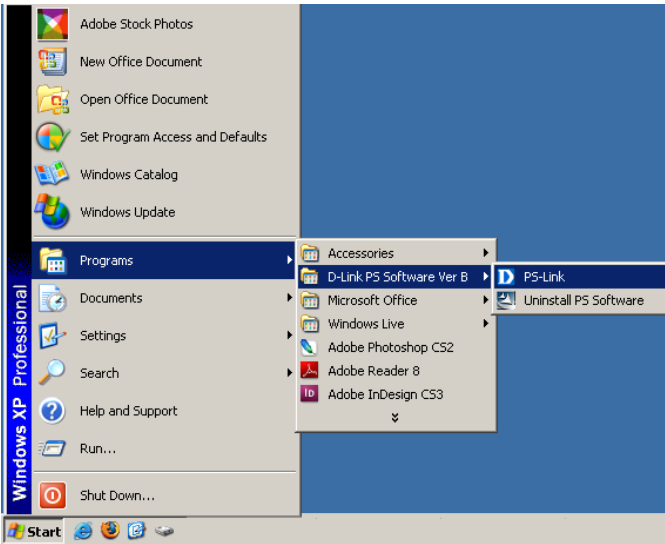

PS-Link will then start and automatically search for MFP servers in the same network segment. If the installation has been successful, you will see that the name of your MFP server has been discovered and is listed in the **Server Name** column. If your MFP server is not listed, please check your network connectivity and click the **Discover** button again.

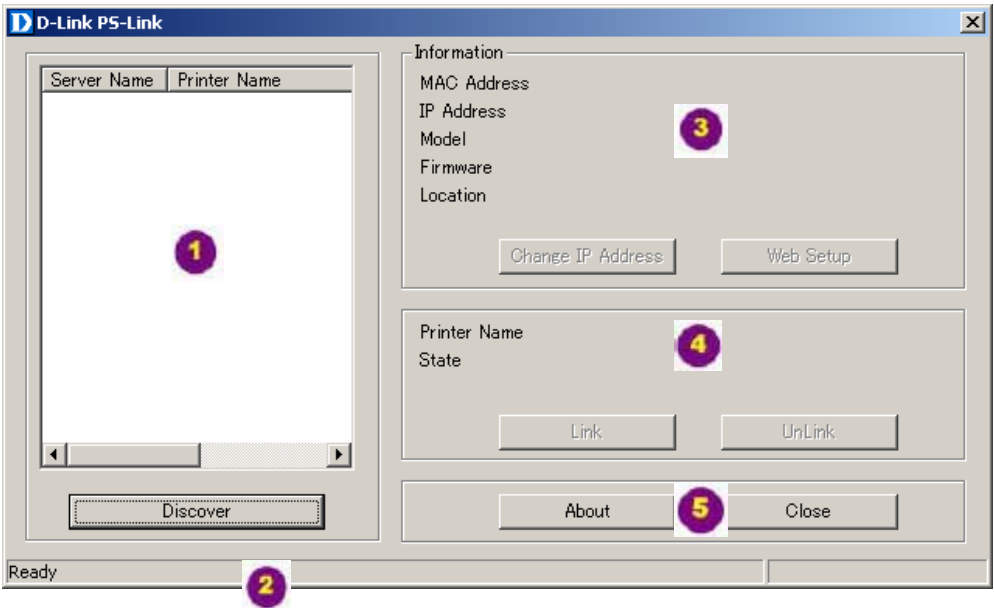

1 Server Name: This list displays the name of the MFP Servers within the network.

Discover: Click this button to search for more MFP Servers.

2 Status Bar: The status bar at the bottom of the screen displays the current system status and number of connected MFP servers.

3 Information: This field displays basic information regarding the selected MFP Server in the Device List.

There are also two buttons: **Change IP Address**, and **Web Setup**. Here is an explanation of each button:

[Change IP Address] - Click this button to bring up the following screen. This screen allows you to change the IP Address of the MFP Server. Select **Manually Assign** to enter a specific IP address for the MFP server or **DHCP Assign Automatically** to assign the server an IP address automatically. Click **OK** to save your changes or **Cancel** to abort.

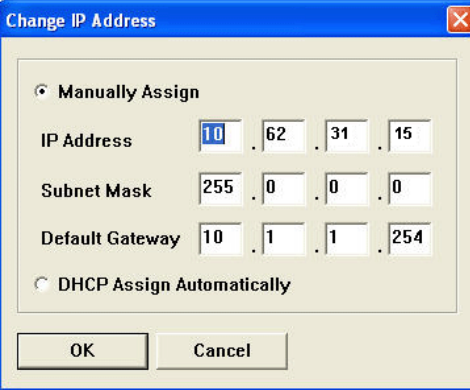

The image shows a dialog box titled "Change IP Address" with a close button in the top right corner. It contains two radio button options: "Manually Assign" (which is selected) and "DHCP Assign Automatically". Under "Manually Assign", there are three rows of input fields: "IP Address" with values 10, 62, 31, 15; "Subnet Mask" with values 255, 0, 0, 0; and "Default Gateway" with values 10, 1, 1, 254. At the bottom, there are "OK" and "Cancel" buttons.

[Web Setup] – Click this button to launch the web configurator. You can also launch the web configurator by clicking on the name of the server in the Device List.

Product: DPR-1040 Firmware Version: 2.30

Product: DPR-1040 Firmware Version: 2.30

D-Link

DPR-1040 // Setup Advanced Maintenance Status Help

Print Server Setup

PRINT SERVER SETUP

The Print Server Name can be changed below. D-Link does not recommend changing the setting unless asked to do so by your network administrator.

PRINT SERVER NAME

Server Name :

Apply Settings Cancel

Printer Off line

Reboot

Helpful Hints..

Printer Setup:
In this field, you can configure the server name of your print server.

PRINT SERVER

Copyright (C) 2007 D-Link Corporation.



Printer Port: This field displays basic information and the current status of the connected printer. It also allows you to use **Link** and **UnLink**.

[Link] – The function of this button is to simulate the physical connection between the printer and computer via a USB cable. This means you can set up a link by simply clicking this button without physically attaching the printer's USB cable to your computer. This is because the USB cable will be connected from your printer to the print server and not to your computer.

[UnLink] – This button disconnects the simulated link between the printer and the computer.



About: Click this to display the PS-Link version number. Click the **OK** button to close this window.

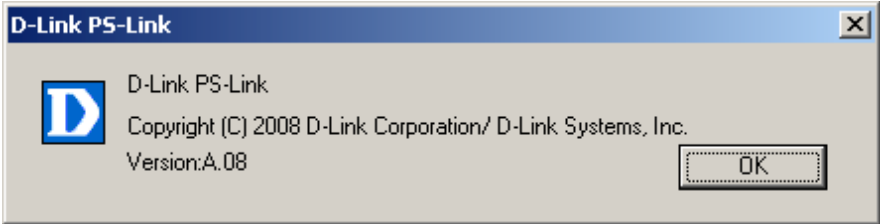

Close: To exit PS-Link, click this button.

Installing and Using MFP/GDI Printers

This section will tell you how to install a MFP/GDI printer through the PS-Link utility. This is helpful when you do not have physical access to the printer.

For PCs with the MFP/GDI printer driver installed:

If your computer already has the MFP/ GDI printer driver installed, you can just click the **[Link]** button in **PS-Link** to complete the connection between the printer and your computer.

For PCs without the MFP/GDI printer driver installed:

If your computer does not have the MFP/GDI printer driver installed, you may use the following procedure:

1. Insert the DPR-1040 installation CD into your computer's CD-ROM drive to install the PS-Link software.
2. Insert the manufacturer's CD-ROM into your computer's CD-ROM drive to initiate the auto-run program.
3. Following the instructions on the manufacturer's installation CD to install the MFP driver and other software until you are requested to attach the printer's USB cable to your computer. At this stage you must use the PS Link utility to simulate the connection and complete the installation.
3. The installation steps may be different depending on the printer and manufacturer brand. Below you will find diagrams for several printers from different manufacturers.

For HP:

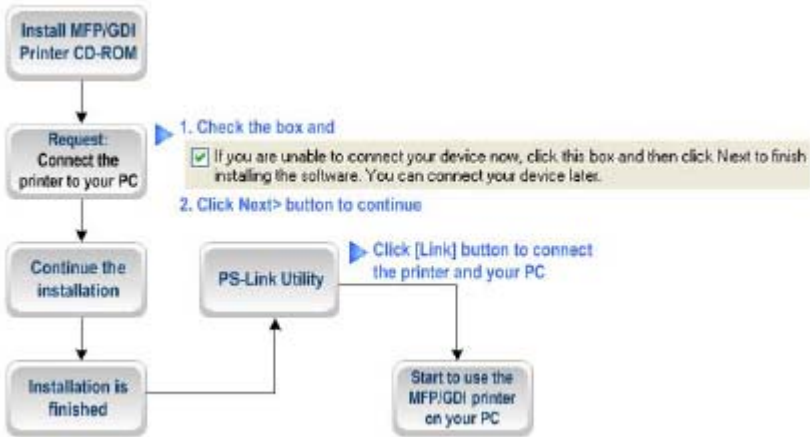

1. When the installation program asks you to connect the USB cable you are allowed to connect it later by checking a box. Click the **Next >** button to continue the rest of the installation.

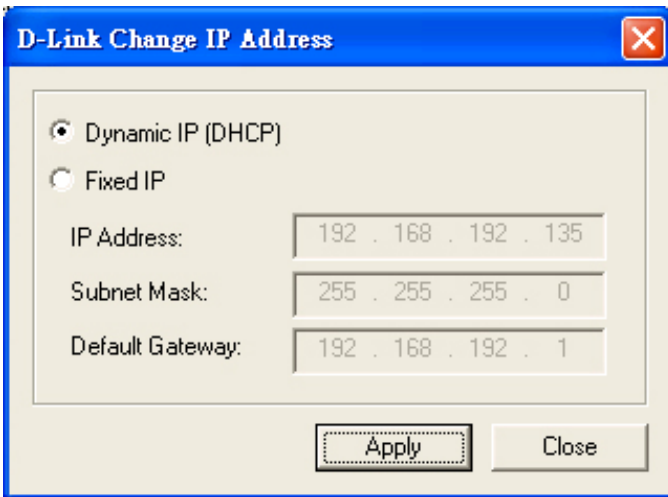

2. When the installation of all drivers has been completed, you may use the **PS-Link**

utility to complete the physical connection between the MFP/GDI printer and your computer by clicking the **[Link]** button.



If the connection has been made successfully, the following message will display. Press **OK** to exit.

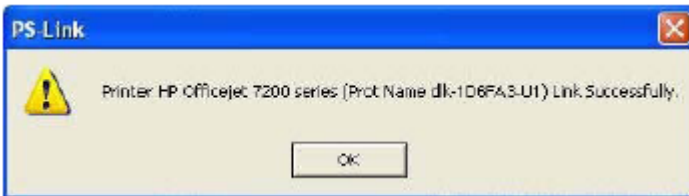

3. Now the MFP/GDI printer is ready to use. You may start to use the MFP/GDI printer through your computer.

For EPSON:

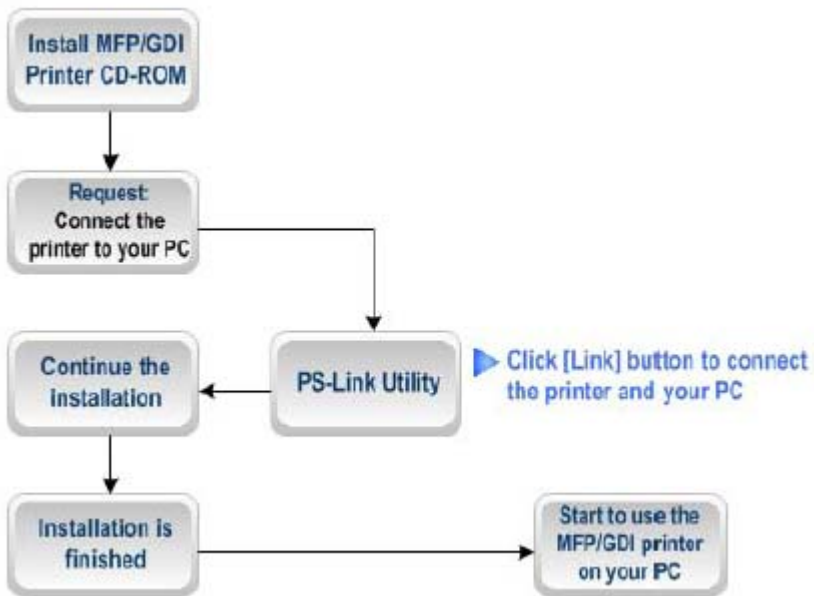

1. When the installation program asks you to connect the USB cable of the MFP/GDI printer to your computer, you are not allowed to ignore it; therefore, you need to use **PS-Link** to simulate a USB connection between your printer and computer.



2. Launch the **PS-Link** utility and click the **[Link]** button.



When the connection has been completed successfully, a message will display. Press **OK** to exit.



3. Now you have to go back to continue the installation of the MFP/GDI printer CD-ROM on your computer in order to complete the rest of installation steps.

4. When the installation is complete, you can start to use the Print, Scan, Copy and Fax functions of the MFP/GDI printer through your computer.

For Canon:

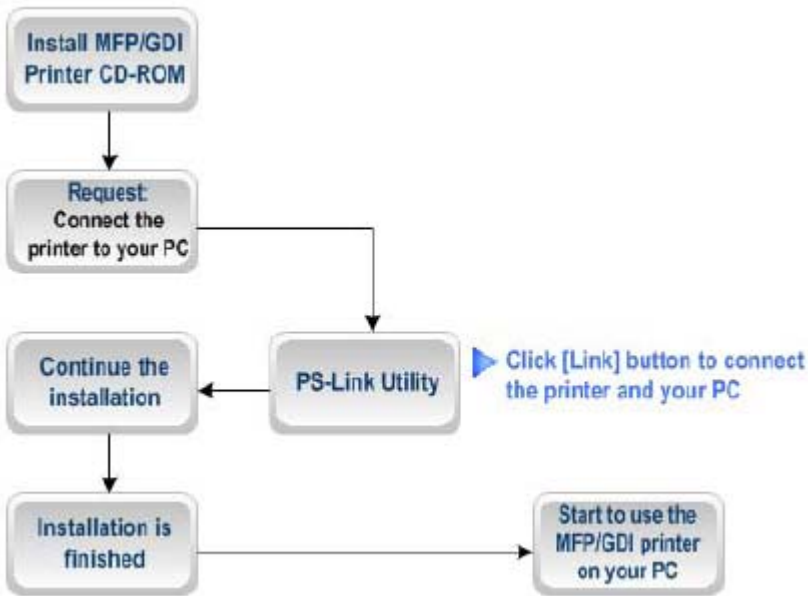

1. When the installation program asks you to connect the USB cable of the MFP/GDI printer to your computer, you are not allowed to ignore it; therefore, you need to use **PS-Link** to simulate a USB connection between your printer and computer.

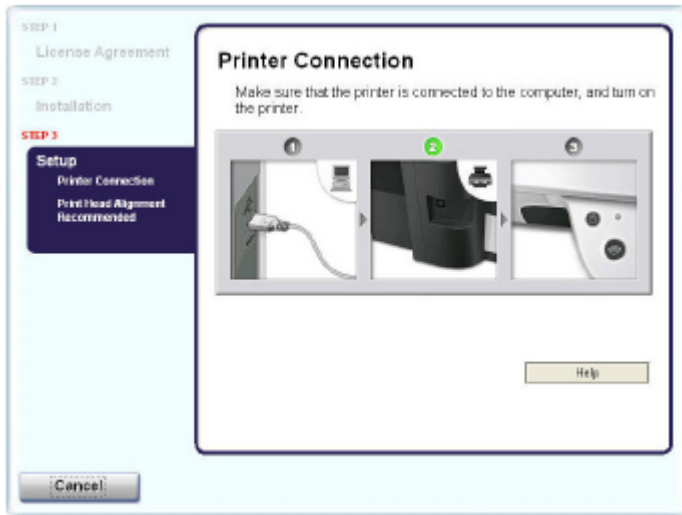

2. Launch the **PS-Link** utility and click the [Link] button.



When the connection has been completed successfully, a message will display. Press **OK** to exit.



3. Now you have to go back to continue the installation of the MFP/GDI printer CD-ROM on your computer in order to complete the rest of installation steps.

4. When the installation is complete, you can start to use the Print, Scan, Copy and Fax functions of the MFP/GDI printer through your computer.

For Lexmark:

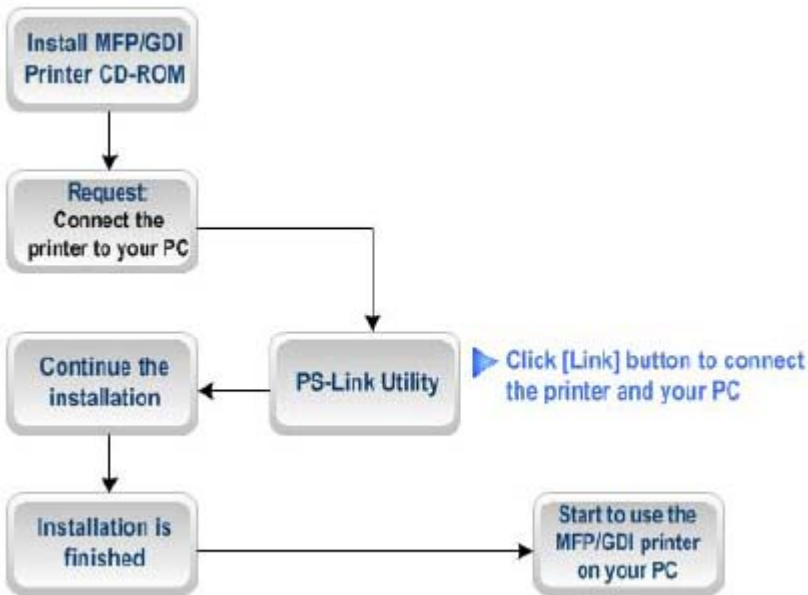

1. When the installation program asks you to connect the USB cable of the MFP/GDI printer to your computer, you are not allowed to ignore it; therefore, you need to use **PS-Link** to simulate a USB connection between your printer and computer.



2. Launch the **PS-Link** utility and click the [Link] button.



When the connection is completed successfully, a message will display. Press **OK** to exit.

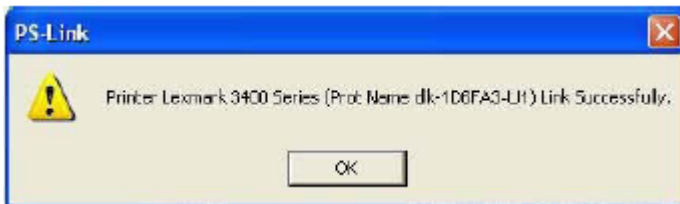

3. Now you have to go back to continue the installation of the MFP/GDI printer CD on your computer in order to complete the rest of installation steps.

4. When the installation is complete, you can start to use the Print, Scan, Copy and Fax functions of the MFP/GDI printer through your computer.

For Samsung:

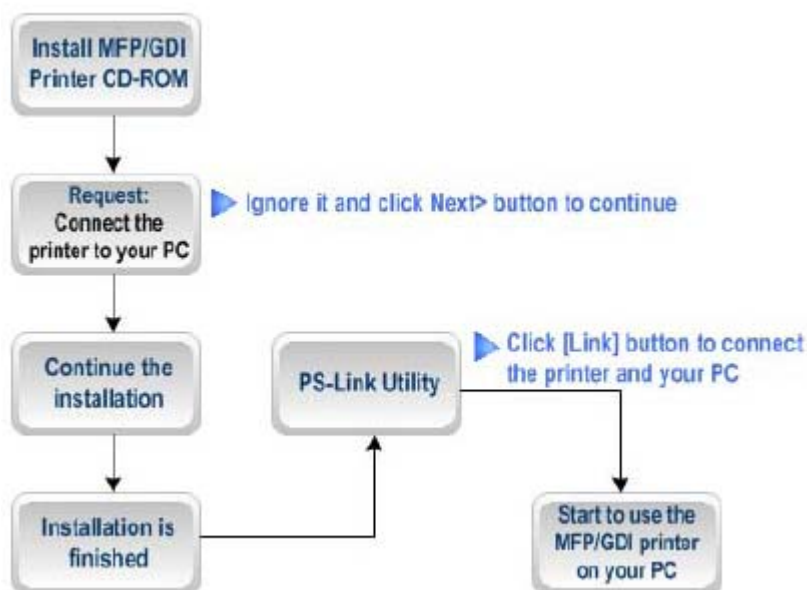

1. When the installation program asks you to connect the printer to your computer, just ignore it and click the **Next>** button to continue.

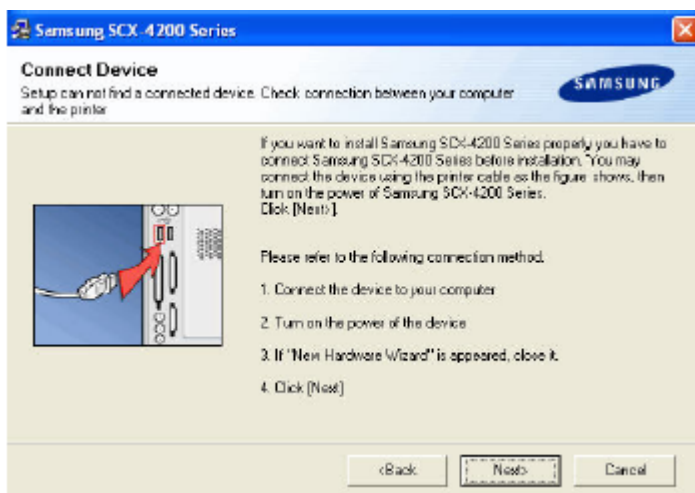

2. The program will prompt you again to connect the two devices, click **No** and continue with the rest of the installation.



3. After the installation of the MFP/GDI printer CD has finished, you may use **PS-Link** to complete the physical connection between the MFP/GDI printer and your computer.

Click the **[Link]** button of the **PS-Link** window as below.

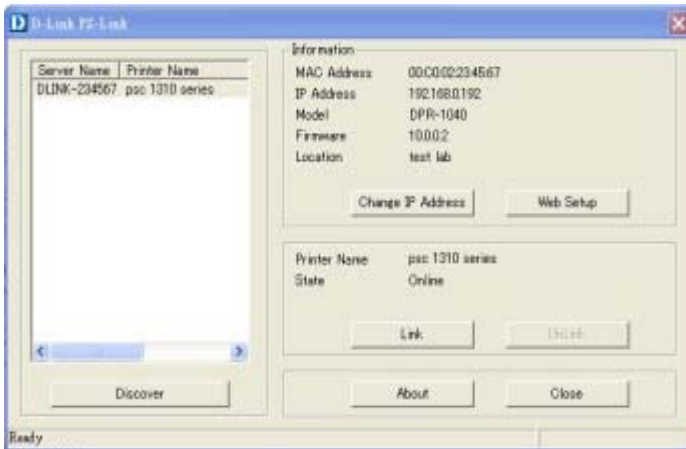

When the connection is successful, a message will display. Press **OK** to exit.

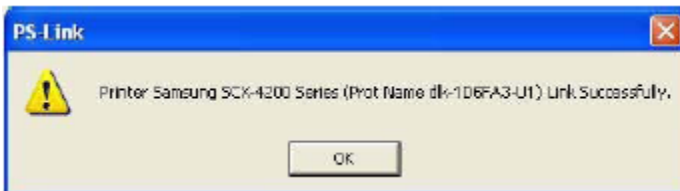

4. Now the MFP/GDI printer is ready to use through your computer.

For Brother:

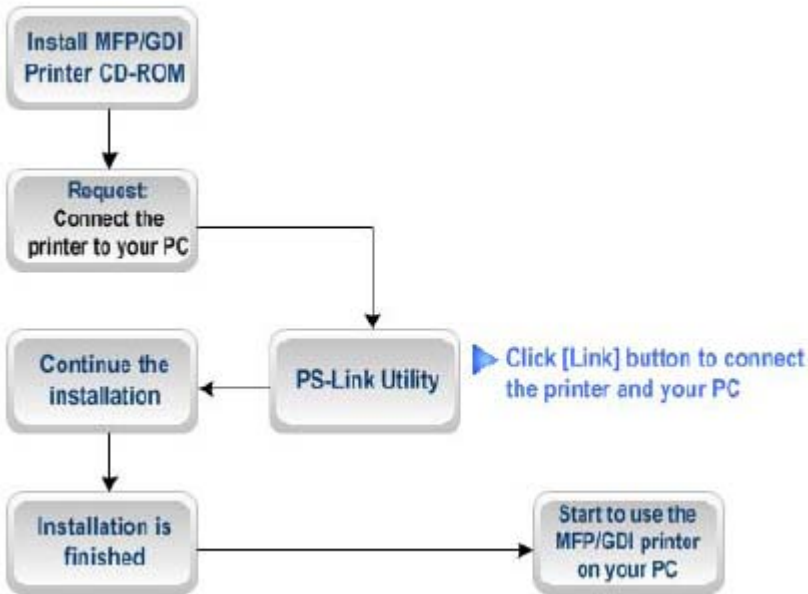

1. When the installation program asks you to connect the USB cable of the MFP/GDI printer to your computer, you are not allowed to ignore it; therefore, you need to use **PS-Link** to simulate a USB connection between your printer and computer.

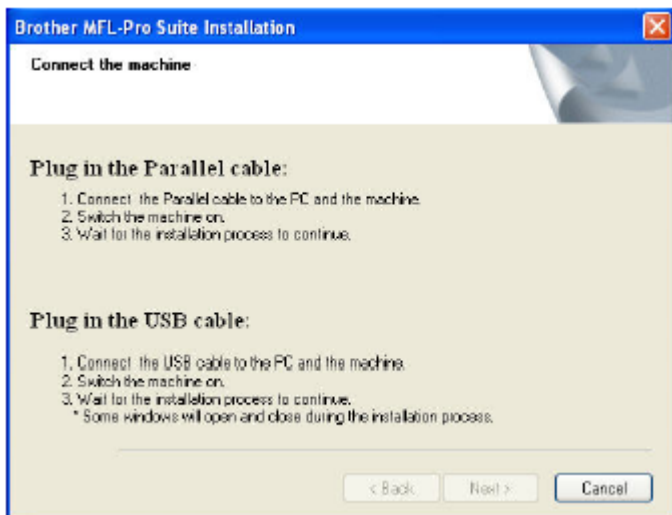

2. Launch the **PS-Link** utility and click the **[Link]** button.



When the connection has been completed successfully, a message will display to inform you. Press **OK** to exit.

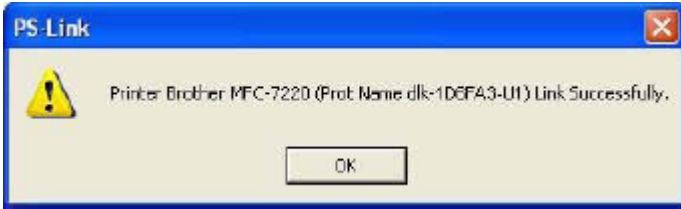

3. Now you have to go back to continue the installation of the MFP/GDI printer CD on your computer in order to complete the rest of installation steps.
4. When the installation is complete, you can start to use the Print, Scan, Copy and Fax functions of the MFP/GDI printer through your computer.

For Fuji Xerox:

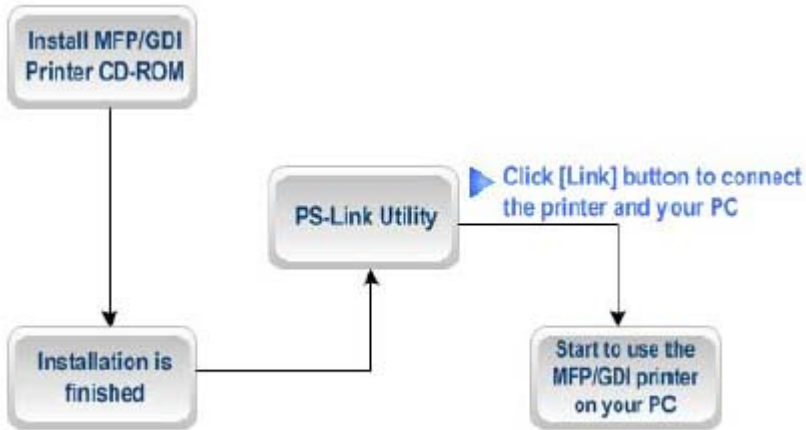

1. The installation program of the Xerox MFP/GDI printer will not request you to make a physical connection between the printer and your computer.

2. After the installation has finished, you will have to link the connection between the MFP/GDI printer and your computer in order to use the printer on your computer. To do this you need to use **PS-Link** to link the two devices.

Launch the **PS-Link** utility and click the [**Link**] button.



When the connection has been completed successfully, a message will display to inform you. Press **OK** to exit.



3. Now the MFP/GDI printer is ready to use through your computer.

Using the Web Configurator

HOME

To begin managing the DPR-1040, launch your browser and go to the following URL address:

dlink-xxxxxx

xxxxxx being the last six digits of the DPR-1040's MAC address. The MAC address can be found on the bottom of the DPR-1040.

You can also access the web configurator by typing the IP address of the device. The default IP address is **192.168.0.10** but this may have changed if you have a DHCP server on your network.

When you enter the correct URL, a password input dialog will pop up. Input "admin" in the **User name** field, leave the **Password** field as blank, and click the **OK** button to login.

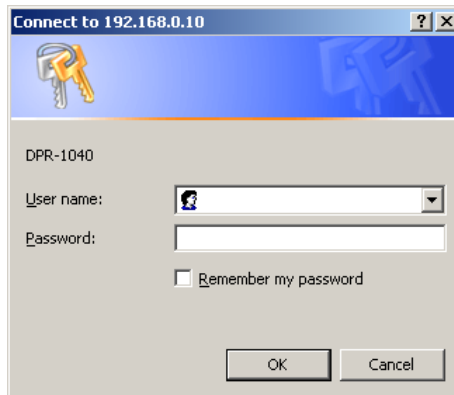

This is the main screen of the Print Server's web configurator. In addition to product information, there are five links on the top of the main screen: **Setup**, **Advanced**, **Maintenance**, **Status**, and **Help**. Clicking a link from the bar will display its submenu, selecting an option from the submenu will display the content in the center of the screen.

Product: DPR-1040		Firmware Version: A.02			
D-Link					
DPR-1040 //	Setup	Advanced	Maintenance	Status	Help
Print Server Setup	<p>PRINT SERVER SETUP</p> <p>The Print Server Name and Port Name can be changed below. D-Link does not recommend changing these settings unless asked to do so by your network administrator.</p> <p>PRINT SERVER NAME</p> <p>Server Name : <input type="text" value="dlink-234567"/></p> <p>Location (optional) : <input type="text"/></p> <p>PORT SETTINGS</p> <p>USB : Port Name : <input type="text" value="dlink-234567-u1"/></p> <p>Description : <input type="text"/> (optional)</p> <p style="text-align: center;"> <input type="button" value="Apply Settings"/> <input type="button" value="Cancel"/> </p>				<p>Helpful Hints..</p> <p>Printer Setup: In this field, you can configure the basic information of your print server.</p> <p>Port Setting: In this field, you can assign the Port Name for the print server, and the description for the Printer port. It also allows you to select the P/L Printer setting (Yes or No).</p>
LAN Setup					
Wireless Setup					
Printer Setup					
 <p>Printer On line</p> <p><input type="button" value="Reboot"/></p>					
PRINT SERVER					
Copyright (C) 2008 D-Link Corporation / D-Link Systems, Inc.					

SETUP > Print Server Setup

The Print Server Setup screen allows you to modify the Print Server Name and Port Name. D-Link does not recommend changing these settings unless asked to do so by your network administrator.

Product: DPR-1040		Firmware Version: A.02			
D-Link					
DPR-1040	Setup	Advanced	Maintenance	Status	Help
Print Server Setup	PRINT SERVER SETUP				Helpful Hints.. Printer Setup: In this field, you can configure the basic information of your print server. Port Setting: In this field, you can assign the Port Name for the print server, and the description for the Printer port. It also allows you to select the P/L Printer setting (Yes or No).
LAN Setup	The Print Server Name and Port Name can be changed below. D-Link does not recommend changing these settings unless asked to do so by your network administrator.				
Wireless Setup	PRINT SERVER NAME				
Printer Setup	Server Name : <input type="text" value="dlink-234567"/> Location (optional) : <input type="text"/>				
 Printer On line <input type="button" value="Reboot"/>	PORT SETTINGS				
	USB : Port Name : <input type="text" value="dlk-234567-u1"/> Description : <input type="text"/> (optional)				
	<input type="button" value="Apply Settings"/> <input type="button" value="Cancel"/>				
PRINT SERVER					
Copyright (C) 2008 D-Link Corporation / D-Link Systems, Inc.					

Print Server Name

In this section, you can configure the basic information of MFP server. The basic information contains a name of the print server, assigned in the **Server Name** field, and a location for the print server, assigned in **Location** (optional) field.

Port Settings

In this section you can assign the Port Name for the print server and the description for the USB printer port.

Click the **Apply Settings** button to save any changes or click **Cancel** to exit.

SETUP > LAN Setup

The LAN Setup screen allows you configure the print server's local network settings. Please note that this section is optional and you should not need to change any of the settings here to get the print server up and running.

Product: DPR-1040 Firmware Version: A.02

D-Link

DPR-1040 // Setup Advanced Maintenance Status Help

Print Server Setup
LAN Setup
Wireless Setup
Printer Setup

Printer On line
Reboot

LAN SETUP

This section allows you to configure the local network settings of your print server. Please note that this section is optional and you should not need to change any of the settings here to get your print server up and running.

TCP/IP

IP Address : Automatically Assign
 Manually Assign

IP Address :
Subnet Mask :
Default Gateway :

Apply Settings Cancel

Helpful Hints...

TCP/IP:
This section allows you to configure the TCP/IP setting: **IP Address**.

PRINT SERVER

Copyright (C) 2008 D-Link Corporation / D-Link Systems, Inc.

TCP/IP

These fields allow you to assign an IP address automatically or manually. When clicking **Manually Assign**, you should enter the following information in the boxes:

IP Address, **Subnet Mask**, and **Default Gateway**.

If you have made changes click **Apply Settings** to save them or click **Cancel** to exit.

SETUP > Wireless Setup

Use this screen to set up your wireless connection. You can change the wireless connection details and also apply/remove wireless security such as WEP or WPA.

Product: DPR-1040 Firmware Version: A.02

Product: DPR-1040 Firmware Version: A.02

D-Link

DPR-1040 // Setup Advanced Maintenance Status Help

Print Server Setup
LAN Setup
Wireless Setup
Printer Setup

WIRELESS SETUP

From this page you can configure the print server to wirelessly connect to your LAN via an 802.11 (Wi-Fi) access point or router.

WIRELESS INTERFACE

Connection Mode : Infrastructure Ad-Hoc

SSID :

Wireless Channel :

ENCRYPTION

Wireless Security

Helpful Hints..

Wireless Interface:
Connection Mode : Select one of the two connection modes. **Infrastructure (default)** - Connects to compatibly configured wireless AP or router in a WLAN. **Ad-Hoc** - Connect to compatibly configured wireless clients in the peer-to-peer mode.

SSID : Assign the SSID in this box. You can manually input the name or select one from the pull-down menu. To search the available wireless AP within the network, click the **Site Survey** button.

Encryption:
This field allows you to configure the settings of data encryption. Please remember that the key must be set before the data encryption is enforced.

PRINT SERVER

Copyright (C) 2008 D-Link Corporation / D-Link Systems, Inc.

Wireless Interface

[Connection Mode] Select the type of wireless network you are connecting to. Select **Infrastructure** if you are connecting to a wireless router or access point. Select **Ad-Hoc** to connect directly to a computer with an Ad-Hoc network set up.

[SSID] Type the name of the network the Print Server is connecting to. Click the **Site**

Survey button to see the names of the wireless networks already in-range.

[Wireless Channel] Select the channel that the wireless network you are connecting to is using.

Encryption

[Wireless Security] Select the type of wireless security the network you are connecting to is using. This may be WEP, WPA or WPA2-PSK.

Click **Apply Settings** to save your changes. Click **Cancel** to exit without saving any changes.

SETUP > Printer Setup

The Printer Setup screen allows you to install the printer drivers for the printer currently connected to your print server.

Product: DPR-1040 Firmware Version: A.02

D-Link

DPR-1040	Setup	Advanced	Maintenance	Status	Help
----------	-------	-----------------	-------------	--------	------

Print Server Setup
LAN Setup
Wireless Setup
Printer Setup

 [Printer On line](#)

NETWORK PRINTER WIZARD

The Network Printer Wizard will allow you to install the printer drivers for the printer currently connected to your print server. Click **Next** to continue.

Note: When you click **Next** you will be asked to download and run some software. This is the Network Printer Wizard so please click **RUN**, and if a second window appears click **RUN** again.

Helpful Hints..
Add A Network Printer Wizard:
Clicking **Next** to download and run a windows wizard program which will install a network printer onto your computer.

PRINT SERVER

Copyright (C) 2008 D-Link Corporation / D-Link Systems, Inc.

Network Printer Wizard

Click **Next** to download a windows wizard program which will install a network printer onto your computer.

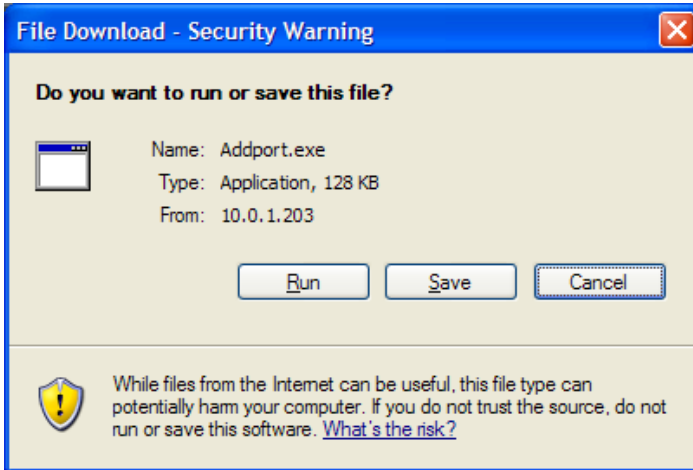

Click **RUN** to download and run the wizard. If a security warning appears click **RUN** again.

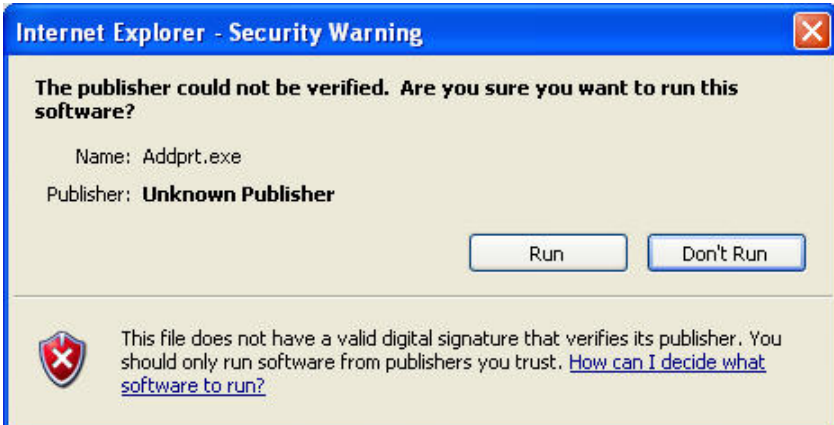

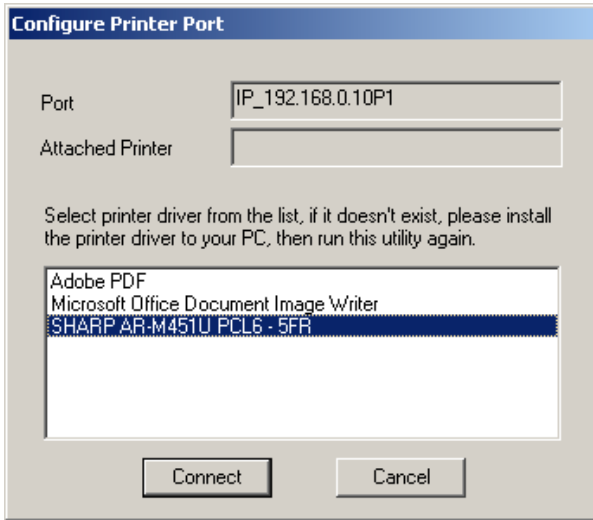

1. Select the correct Windows printer from the list, and click the **Connect** button. If the correct printer type is not listed, install the drivers and run the wizard again.

Using the Web Configurator

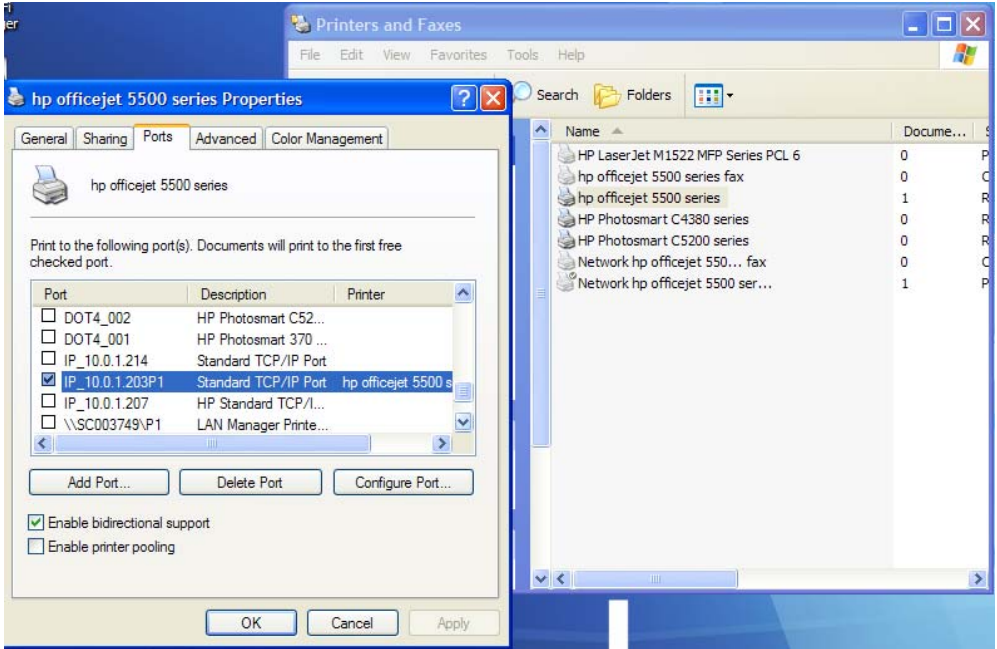

If prompted about sharing the printer, do not enable it.

2. Installation is now complete. You can now print using this printer.

ADVANCED > Advanced LAN

The Advanced LAN screen allows you to change more advanced network settings for the MFP server. It's recommended not to change these settings unless instructed to do so by your network administrator.

Product: DPR-1040 Firmware Version: A.02

D-Link

DPR-1040 // Setup Advanced Maintenance Status Help

Advanced LAN

User Access

Printer On line

Reboot

NETWORK SETTING

Please do not change any of the following settings unless instructed to do so by your network administrator.

TCP/IP

UPnP : Enable Disable

Apply Settings Cancel

Helpful Hints...

TCP/IP:
UPnP allows your print server to be discoverable on the network.

PRINT SERVER

Copyright (C) 2008 D-Link Corporation / D-Link Systems, Inc.

TCP/IP

UPnP: This option allows you to enable or disable UPnP.

ADVANCED > User Access

The User Access screen allows you to create and maintain an authorized list of users that are allowed to access the MFP server.

Product: DPR-1040 Firmware Version: A.02

D-Link

DPR-1040 // Setup Advanced Maintenance Status Help

Advanced LAN

User Access

Printer On line

Reboot

USER ACCESS

This section allows you to build and maintain an authorised list of users that are allowed access to the print server.

Enable Authorised User List : Yes No

Apply Settings Cancel

AUTHORISED USERS

Add User : PC Description : (optional)

MAC Address : (Example : 00 80 C8 A1 B2 C3)

Add

PC Description	MAC Address	Delete
		Delete

PRINT SERVER

Copyright (C) 2008 D-Link Corporation / D-Link Systems, Inc.

Helpful Hints...

User Access:
This section allows you to build and maintain an authorized list of users that are allowed to print via the print server.

Authorised Users:
You can add/delete the user(s) to/from the User List. The User List at the bottom of the screen displays the current defined user and related information for the print server.

User Access

By enabling the **Enable Authorised User List** option (**Yes**), the users in the User List below will be permitted to access the print server. Any user who is not added to this list will not be allowed to access the print server. Once you have changed the settings, click the **Apply Settings** button to store the settings or click **Cancel** to exit.

Authorised Users

You can add or delete any user to or from the **User List**. The **User List** at the bottom

of the screen displays the currently defined users and their related information.

Product: DPR-1040
Firmware Version: A.02

D-Link

DPR-1040 //
Setup
Advanced
Maintenance
Status
Help

Advanced LAN

User Access

Printer
On line

Reboot

USER ACCESS

This section allows you to build and maintain an authorised list of users that are allowed access to the print server.

Enable Authorised User List : Yes No

AUTHORISED USERS

Add User : PC Description : (optional)

MAC Address : (Example : 00 80 C8 A1 B2 C3)

	PC Description	MAC Address	Delete
<input type="button" value="Delete"/>			

Helpful Hints...

User Access:
This section allows you to build and maintain an authorized list of users that are allowed to print via the print server.

Authorised Users:
You can add/delete the user(s) to/from the User List. The User List at the bottom of the screen displays the current defined user and related information for the print server.

PRINT SERVER

Copyright (C) 2008 D-Link Corporation / D-Link Systems, Inc.

MAINTENANCE > Password

The Password screen allows you to change the password of the MFP server by entering the current password in the **Current Password** field and your new password in the **New Password** and **Confirm Password** fields. Click the **Apply Settings** button to save the new password, or click **Cancel** to exit without saving.

NOTE: The default password for the MFP server is blank.

Product: DPR-1040		Firmware Version: A.02			
DPR-1040 //	Setup	Advanced	Maintenance	Status	Help
Password Save/Restore Settings Firmware Upgrade Diagnostics Printer On line Reboot	<div style="border: 1px solid black; padding: 10px;"> <p>SET PASSWORD (OPTIONAL)</p> <p>To change the print server password, please type in the current password, then the new password twice.</p> <p style="text-align: center;">User Name : Admin</p> <p>Current Password : <input type="text"/></p> <p>New Password : <input type="text"/></p> <p>Confirm Password : <input type="text"/></p> <p style="text-align: center;"> <input type="button" value="Apply Settings"/> <input type="button" value="Cancel"/> </p> </div>				Helpful Hints.. Set Password: Click Apply Settings to set new password .
PRINT SERVER					
Copyright (C) 2008 D-Link Corporation / D-Link Systems, Inc.					

MAINTENANCE > Save/Restore Settings

The Save/Restore Settings screen allows you to save the current device configuration in a computer for later backup. It also allows you to reload a previous configuration.

To save the current device configuration click the **[Save]** button. To reload a previous configuration click **[Browse]** and select the backup file, then click **[Update Settings]** to reload it. You can also return the device to factory default settings by clicking **[Restore Device]**.

Product: DPR-1040		Firmware Version: A.02			
D-Link					
DPR-1040 //	Setup	Advanced	Maintenance	Status	Help
Password Save/Restore Settings Firmware Upgrade Diagnostics  Printer On line <input type="button" value="Reboot"/>	SAVE/RESTORE SETTINGS This menu allows you to backup the whole configuration and restore it back when necessary.				Helpful Hints... Save/Restore Settings: Click Save to backup your current configuration of the print server to file and then save in the computer. You can reload a configuration that you saved before. Click Browse to point to the backup file, and then click Update Settings .
	SAVE/RESTORE CONFIGURATION Save Settings to Local Hard Drive : <input type="button" value="Save"/> Load Settings From Local Hard Drive : <input type="text"/> <input type="button" value="浏览..."/> <input type="button" value="Update Settings"/> Restore To Factory Default Settings : <input type="button" value="Restore Device"/>				
PRINT SERVER					
Copyright (C) 2008 D-Link Corporation / D-Link Systems, Inc.					

MAINTENANCE > Firmware Upgrade

The Firmware Upgrade screen displays the current firmware information of the MFP server. It also allows you to upgrade the firmware of the MFP server when a new version of firmware is available.

Click **Browse** to point to the firmware file on your computer, and then click **Upgrade**.

Product: DPR-1040		Firmware Version: A.02							
D-Link									
DPR-1040 //	Setup	Advanced	Maintenance	Status	Help				
Password Save/Restore Settings Firmware Upgrade Diagnostics  Printer On line Reboot	<div style="background-color: #f4a460; padding: 5px;">FIRMWARE UPGRADE</div> <p style="color: red; font-size: small;">Note: Please do not upgrade the firmware on this print server unless instructed to do so by D-Link technical support.</p> <div style="background-color: #333; color: white; padding: 5px;">FIRMWARE INFORMATION</div> <table border="1" style="width: 100%; border-collapse: collapse;"> <tr> <td style="text-align: right;">Firmware Version :</td> <td>A.02</td> </tr> <tr> <td style="text-align: right;">Release Date :</td> <td>2008-09-19</td> </tr> </table> <div style="background-color: #333; color: white; padding: 5px;">FIRMWARE UPGRADE</div> <p style="color: red; font-size: small;">Note: Some firmware upgrades reset the configuration options to factory defaults. Before performing an upgrade, be sure to save the current configuration from the Maintenance->Save/Restore Settings screen.</p> <p>To Upgrade the firmware, enter the name of the firmware upgrade file, and click the Upgrade button.</p> <p>Upgrade : <input type="text"/> <input type="button" value="Browse..."/></p> <p style="text-align: center;"><input type="button" value="Upgrade"/></p>				Firmware Version :	A.02	Release Date :	2008-09-19	Helpful Hints.. Firmware Upgrade: When a new version of firmware is available (e.g. downloading from the D-Link website), you can upgrade the firmware of your print server. Click Browse to point to the firmware file, and then click Upgrade .
Firmware Version :	A.02								
Release Date :	2008-09-19								
PRINT SERVER									
Copyright (C) 2008 D-Link Corporation / D-Link Systems, Inc.									

MAINTENANCE > Diagnostics

The Diagnostics screen allows you to test the printing for each printer connected via USB to the device. After making the port selection, click the **Print Test Page** button to print a test page.

The screenshot shows the web configurator interface for a D-Link DPR-1040 device. At the top, it displays 'Product: DPR-1040' and 'Firmware Version: A.02'. Below this is a large orange banner with the 'D-Link' logo. A navigation bar contains tabs for 'DPR-1040', 'Setup', 'Advanced', 'Maintenance', 'Status', and 'Help'. The 'Maintenance' tab is active, showing a 'DIAGNOSTICS' section with a description: 'This menu allows you to test the printing for every port.' Below this is a 'PRINT TEST' section with a 'Port Selection' area. A radio button is selected for 'USB (psc 1310 series)', and a 'Print Test Page' button is visible. On the left side, there is a sidebar with options: 'Password', 'Save/Restore Settings', 'Firmware Upgrade', and 'Diagnostics'. Below 'Diagnostics' is a printer icon with the text 'Printer On line' and a 'Reboot' button. On the right side, there is a 'Helpful Hints..' section with the text: 'Print Test: Click: **Print Test Page** to print a test page.' At the bottom of the interface, it says 'PRINT SERVER' and 'Copyright (C) 2008 D-Link Corporation / D-Link Systems, Inc.'

STATUS > Device Info

The Device Info screen displays the status of your MFP Server, printer, and network for your reference.

Product: DPR-1040		Firmware Version: A.02			
D-Link					
DPR-1040 //	Setup	Advanced	Maintenance	Status	Help
Device Info	DEVICE INFO The following shows the general system information.				Helpful Hints... Print Server Status: The information about the print server, including the firmware version, and MAC/IP address, can be found in this field. Printer Status: The items in this field display the information of the printer, such as the given name for the printer, speed, and printer status. LAN Status: You can monitor the networking status in this field, including the network connection and speed.
Network	PRINT SERVER STATUS Server Name : dlink-234567 Model : DPR-1040 Firmware Version : A.02 (2008 09 19) MAC Address : 00 C0 02 23 45 67 IP Address : 192.168.0.10 (Manual)				
Wireless	PRINTER STATUS USB : Printer Name : psc 1310 series Printer Speed : USB full speed Printer Status : Online				
 Printer On line <input type="button" value="Reboot"/>	LAN STATUS Link : No Speed : Full Duplex :				
<input type="button" value="Refresh"/>					
PRINT SERVER					
Copyright (C) 2008 D-Link Corporation / D-Link Systems, Inc.					

Print Server Status

The fields in this section display the server name, firmware version of the device and MAC/IP address.

Printer Status

The items in this section display information regarding the printer connected to the

USB port such as name, speed, and printer status.

LAN Status

You can monitor the networking status in this field, including the network connection status and speed.

STATUS > Network

The Network screen displays the general network status of your print server, including:

Auto IP

This section displays the current settings of DHCP/BOOTP and UPnP.

The items in this screen are configured in **Advanced > Advanced LAN**.



The screenshot shows the web configurator interface for a D-Link DPR-1040 print server. At the top, it displays 'Product: DPR-1040' and 'Firmware Version: A.02'. The D-Link logo is prominently featured. Below the logo is a navigation menu with tabs for 'Setup', 'Advanced', 'Maintenance', 'Status', and 'Help'. The 'Status' tab is selected, and the 'Network' sub-tab is active. The main content area is titled 'NETWORK STATUS' and contains the following text: 'The following shows the general networking status.' Below this, there is a section for 'AUTO IP' with the following settings: 'DHCP/BOOTP : Disable (IP : 192.168.0.10)' and 'UPnP : Enable (IP : 192.168.0.10)'. A 'Refresh' button is located below the settings. On the left side, there is a sidebar with 'Device Info', 'Network', and 'Wireless' sections. The 'Printer' icon is shown as 'On line' and there is a 'Reboot' button. On the right side, there is a 'Helpful Hints..' section with a note about 'Auto IP' settings. At the bottom, it says 'PRINT SERVER' and 'Copyright (C) 2008 D-Link Corporation / D-Link Systems, Inc.'

Product: DPR-1040	Firmware Version: A.02				
D-Link					
DPR-1040	Setup	Advanced	Maintenance	Status	Help
Device Info	NETWORK STATUS				Helpful Hints..
Network	The following shows the general networking status.				Auto IP: This field contains the current settings of TCP/IP, including DHCP/BOOTP and UPnP. The items in this field are configured in Advanced -> Advanced LAN -> TCP/IP .
Wireless	AUTO IP				
Printer On line	DHCP/BOOTP : Disable (IP : 192.168.0.10)				
Reboot	UPnP : Enable (IP : 192.168.0.10)				
	Refresh				
PRINT SERVER					
Copyright (C) 2008 D-Link Corporation / D-Link Systems, Inc.					

STATUS > Wireless

This screen displays information about the current wireless connection.

You can monitor the connection mode (Infrastructure or Ad-Hoc), link status, SSID, channel, and data encryption status.

Product: DPR-1040		Firmware Version: A.02			
					
DPR-1040	Setup	Advanced	Maintenance	Status	Help
Device Info	WIRELESS STATUS				Helpful Hints.. Wireless Status: In this field, you can monitor the information of the wireless LAN, such as the connection mode (Infrastructure or Ad-Hoc), SSID, channel, data transfer rate, encryption, and the packets status.
Network	The following shows the wireless status.				
Wireless	WIRELESS STATUS				
 Printer On line <input type="button" value="Reboot"/>	Connection Mode : Infrastructure Link : Yes SSID : default(MAC: 00 55 87 46 12 31) Channel : 4 Encryption : No <input type="button" value="Refresh"/>				
PRINT SERVER					
Copyright (C) 2008 D-Link Corporation / D-Link Systems, Inc.					

HELP

The **Help** screen provides you with additional support information regarding the MFP server.

Product: DPR-1040 Firmware Version: A.02

D-Link

DPR-1040 // Setup Advanced Maintenance Status Help

Help

Printer On line

Reboot

HELP

For print server support, please [Visit Online Support](#).

HELP

[Setup](#)

- Print Server Setup
- LAN Setup
- Wireless Setup
- Printer Setup

[Advanced](#)

- Advanced LAN
- User Access

[Maintenance](#)

- Password
- Save/Restore Settings
- Firmware Upgrade
- Diagnostics

[Status](#)

- Device Info
- Network
- Wireless

PRINT SERVER

Copyright (C) 2008 D-Link Corporation / D-Link Systems, Inc.

Reboot

If you want to reset the MFP server, click the **Reboot** button. A screen will display informing you the printer is restarting.

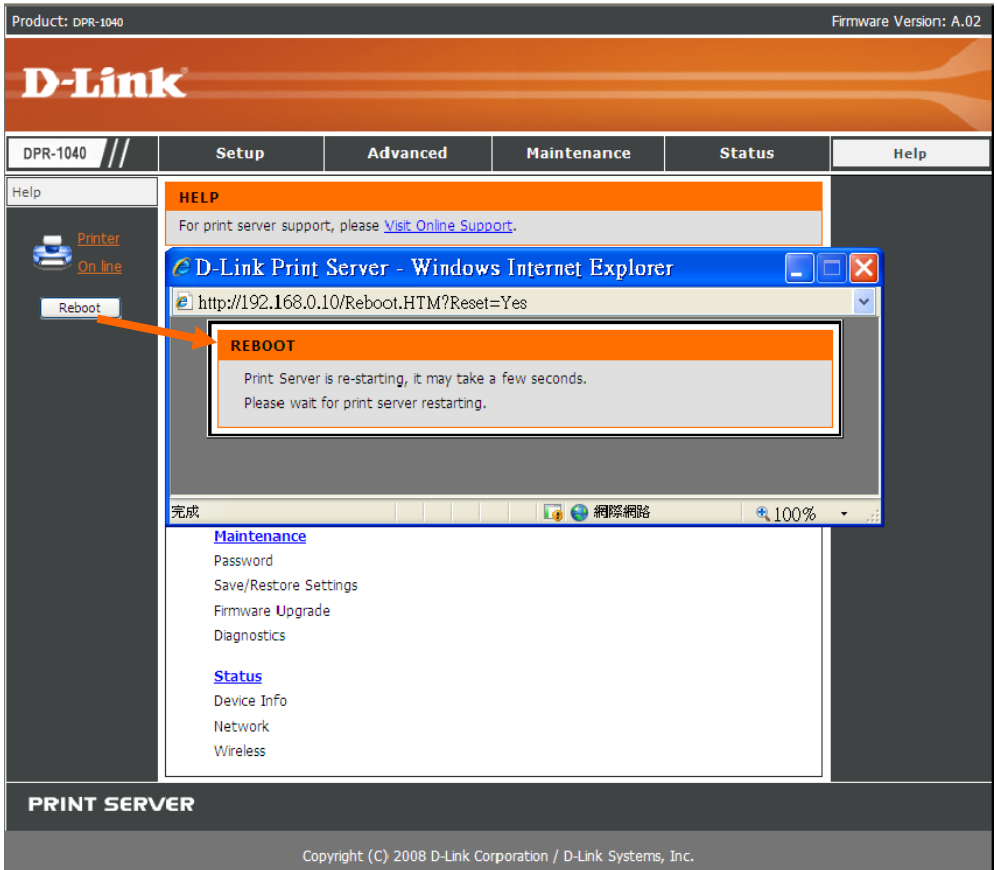

Refresh Printer Status

Click the printer in the left column to refresh the status of the printer.

Product: DPR-1040		Firmware Version: A.02			
D-Link					
DPR-1040	Setup	Advanced	Maintenance	Status	Help
Print Server Setup	PRINT SERVER SETUP				Helpful Hints.. Printer Setup: In this field, you can configure the basic information of your print server. Port Setting: In this field, you can assign the Port Name for the print server, and the description for the Printer port. It also allows you to select the P/L Printer setting (Yes or No).
LAN Setup	The Print Server Name and Port Name can be changed below. D-Link does not recommend changing these settings unless asked to do so by your network administrator.				
Wireless Setup	PRINT SERVER NAME				
Printer Setup	Server Name : <input type="text" value="dlink-234567"/> Location (optional) : <input type="text"/>				
 Printer On line <input type="button" value="Reboot"/>	PORT SETTINGS				
	USB : Port Name : <input type="text" value="dlk-234567-u1"/> Description : <input type="text"/> (optional) <input type="button" value="Apply Settings"/> <input type="button" value="Cancel"/>				
PRINT SERVER					
Copyright (C) 2008 D-Link Corporation / D-Link Systems, Inc.					

TCP/IP Printing for Windows Vista

Go to **Start > Control Panel > Printers**.

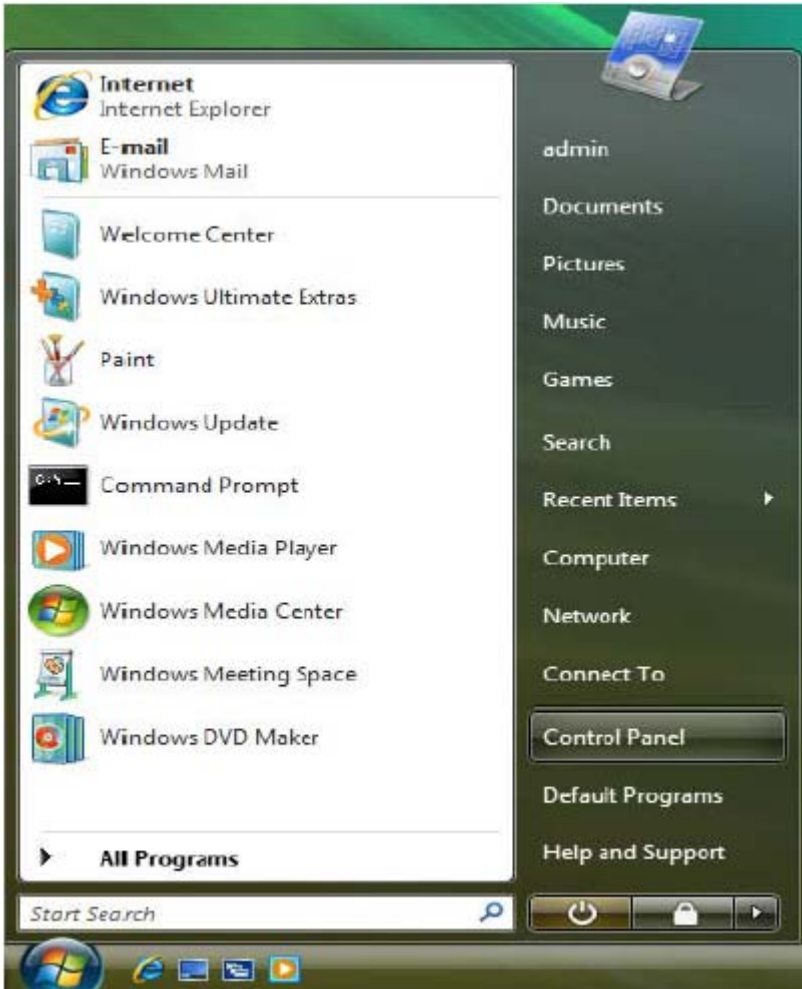

Click **Add a printer**.

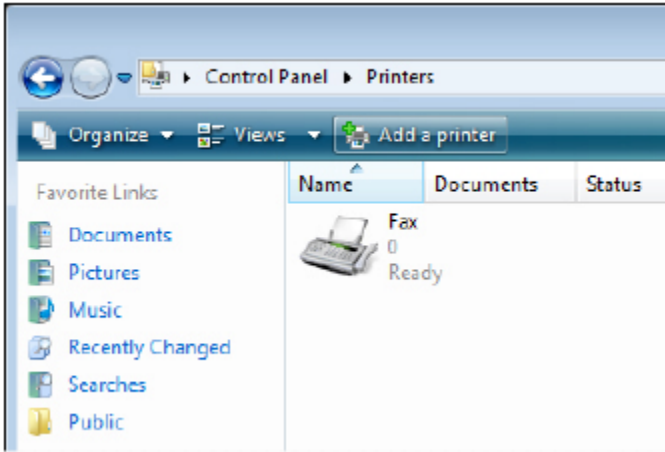

Select the first option, **Add a local printer**, and then click **Next**.

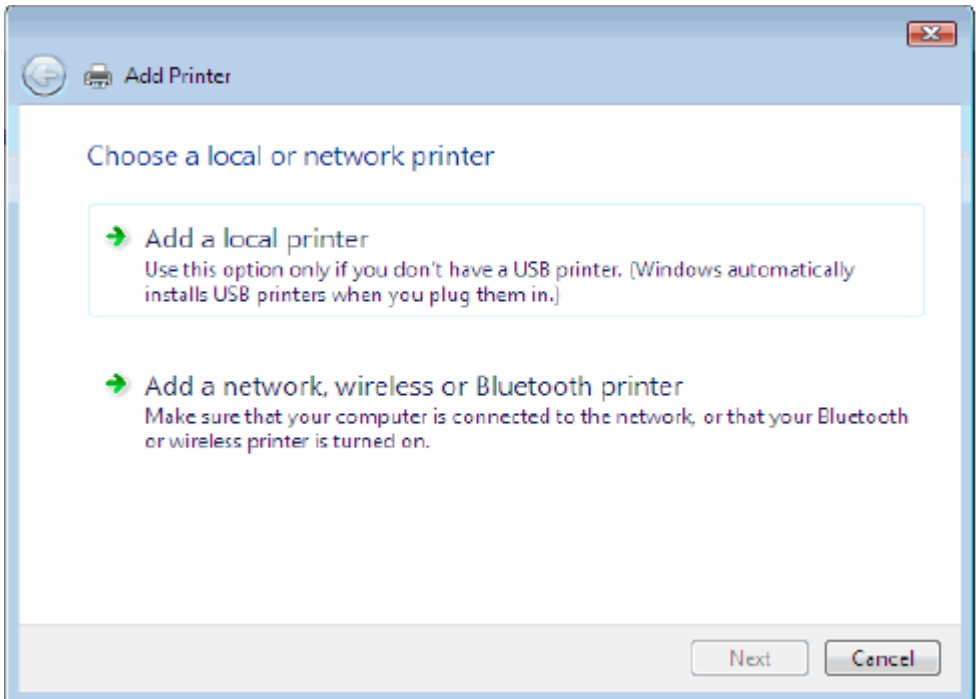

Select the second option, **Create a new port**, and highlight **Standard TCP/IP Port** from the pull-down menu. Click **Next**.

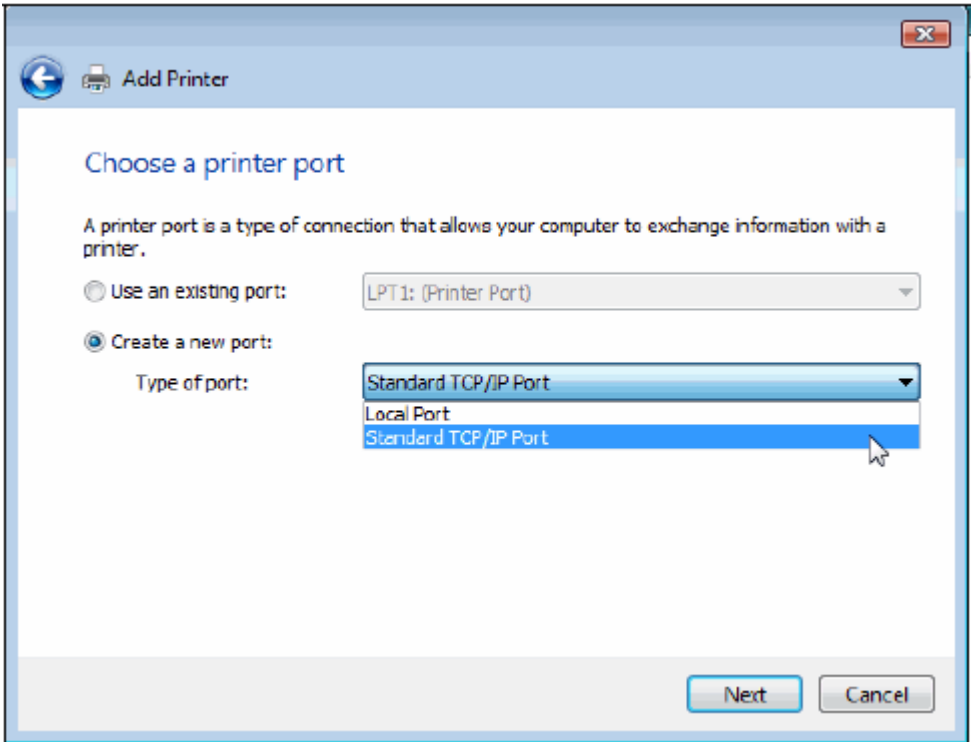

In the **Hostname or IP address field**, type the IP address of the MFP server (e.g. 10.62.31.15), this address can be found in the **PRINTER SERVER STATUS** screen of the MFP server's web configurator. The **Port Name** field will automatically fill in. Click **Next**.

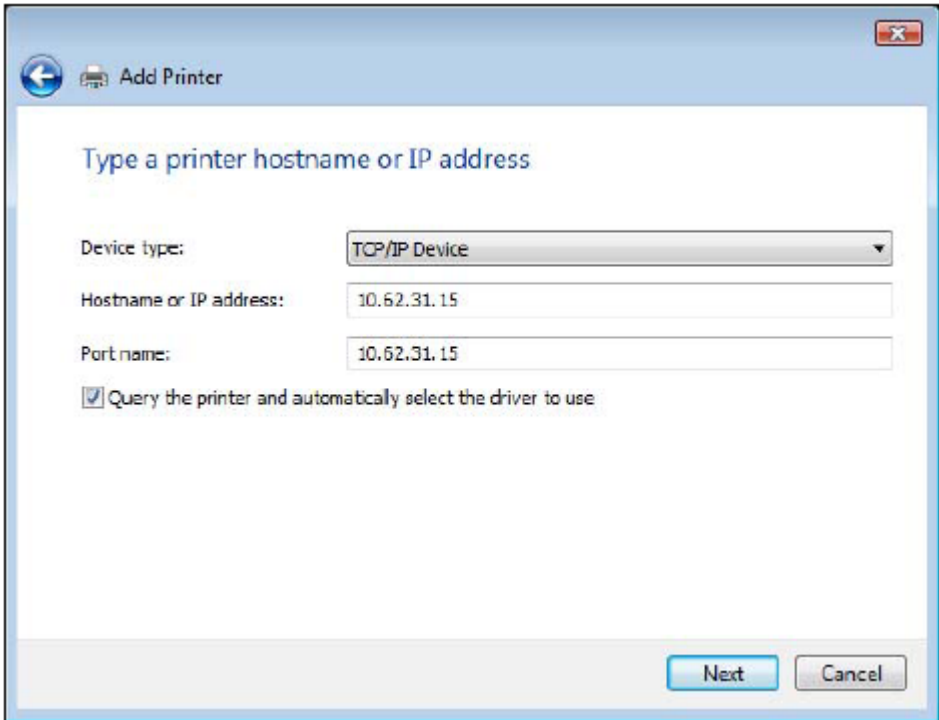

Product: DPR-1040 Firmware Version: A.0B

D-Link

DPR-1040	Setup	Advanced	Maintenance	Status	Help
<p>Device Info</p> <p>Network</p> <p>Wireless</p> <div style="text-align: center;">  <p>Printer Off line</p> <p>Reboot</p> </div>	<p>DEVICE INFO</p> <p>The following shows the general system information.</p> <hr/> <p>PRINT SERVER STATUS</p> <p>Server Name : dlink-234567 Model : DPR-1040 Firmware Version : A.0B (2008-11-21) MAC Address : 00 C0 02 23 45 67 IP Address : 192.168.0.10 (DHCP)</p>				<p>Helpful Hints..</p> <p>Print Server Status: The information about the print server, including the firmware version, and MAC/IP address, can be found in this field.</p> <p>Printer Status: The items in this field display the information of the printer, such as the given name for the printer, speed, and printer status.</p> <p>LAN Status:</p>

In the next screen highlight the printer you wish to add. If the printer is not on the list,

click **[Have Disk]** and insert the printer driver disk that came with your printer to install the printer drivers.

Click **Next**.

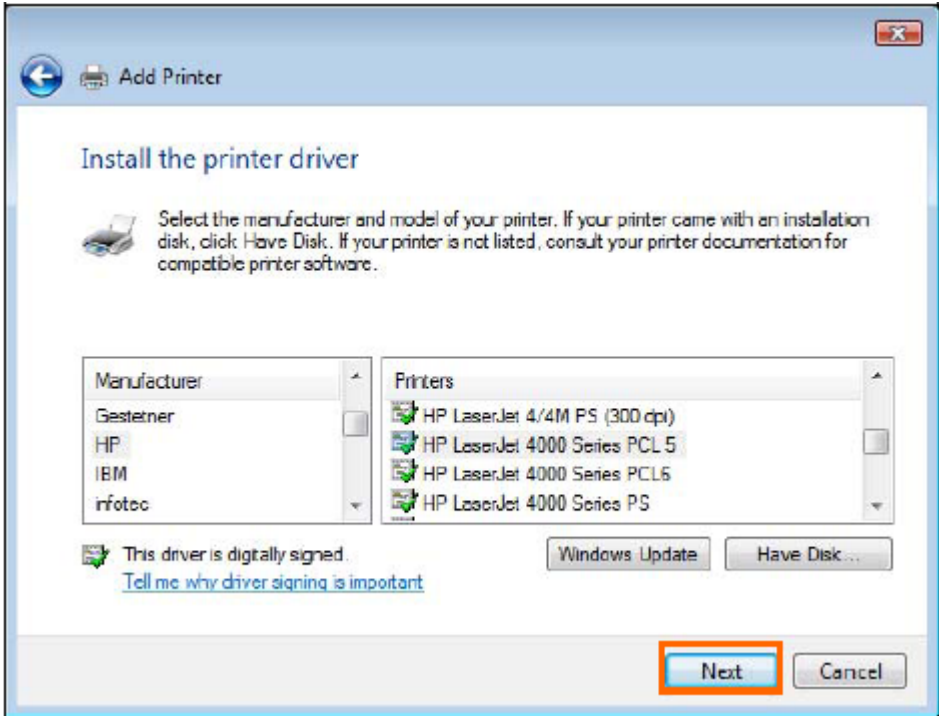

Click **Next** to start installing the printer.

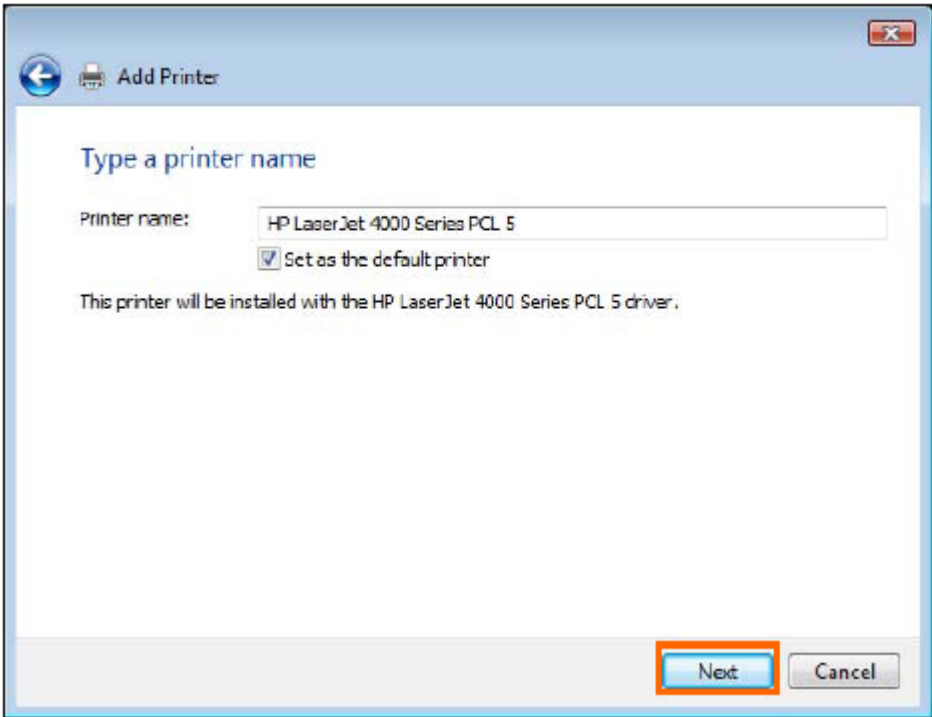

After clicking **Print a test page**, a small dialogue box will display as below. Click **Close**.

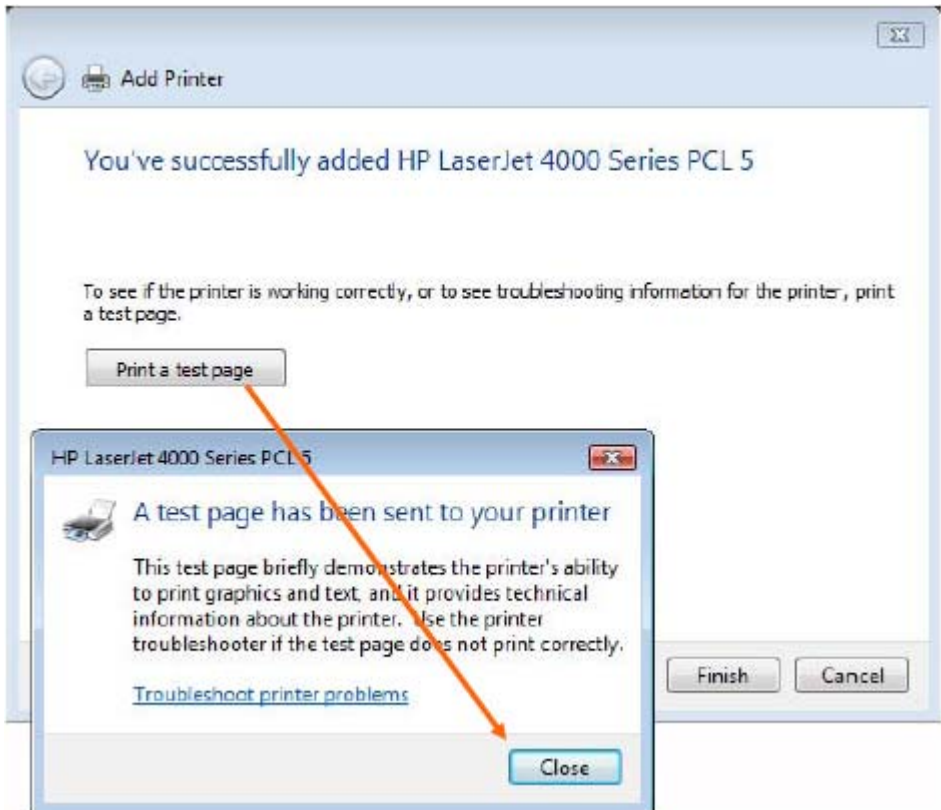

Click **Finish**.

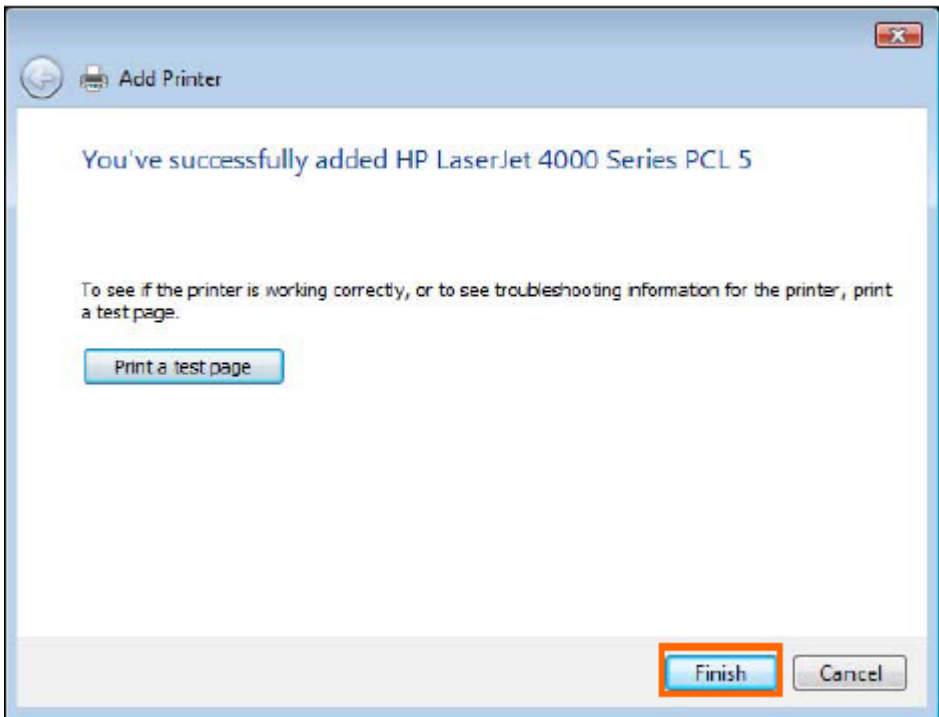

The printer is now ready to use.

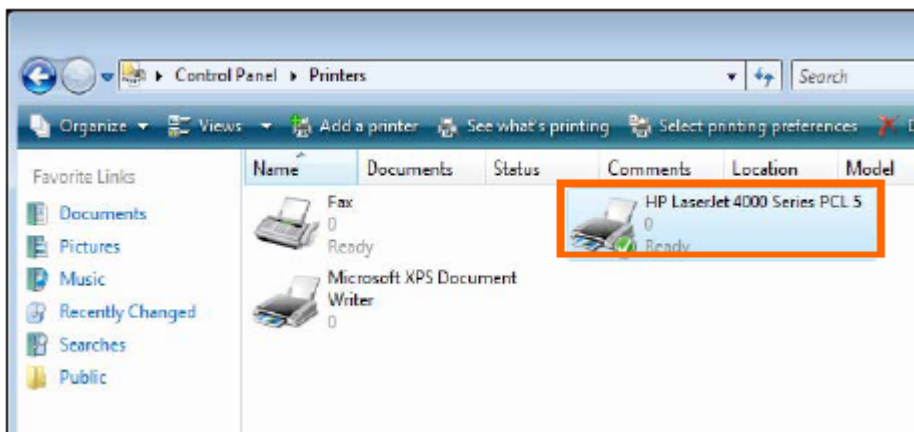

TCP/IP Printing for Windows XP

Go to **Start > Printers and Faxes > Add a Printer.**

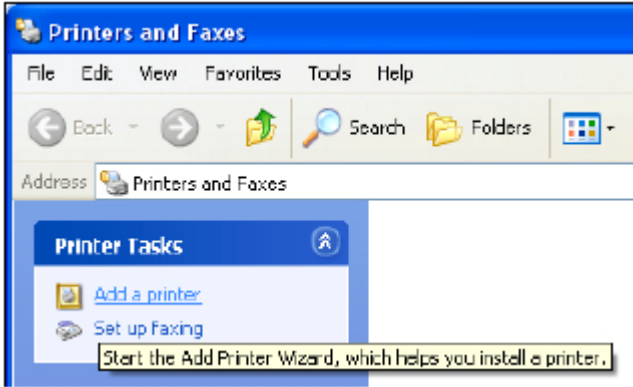

When the following screen displays, click **Next**.

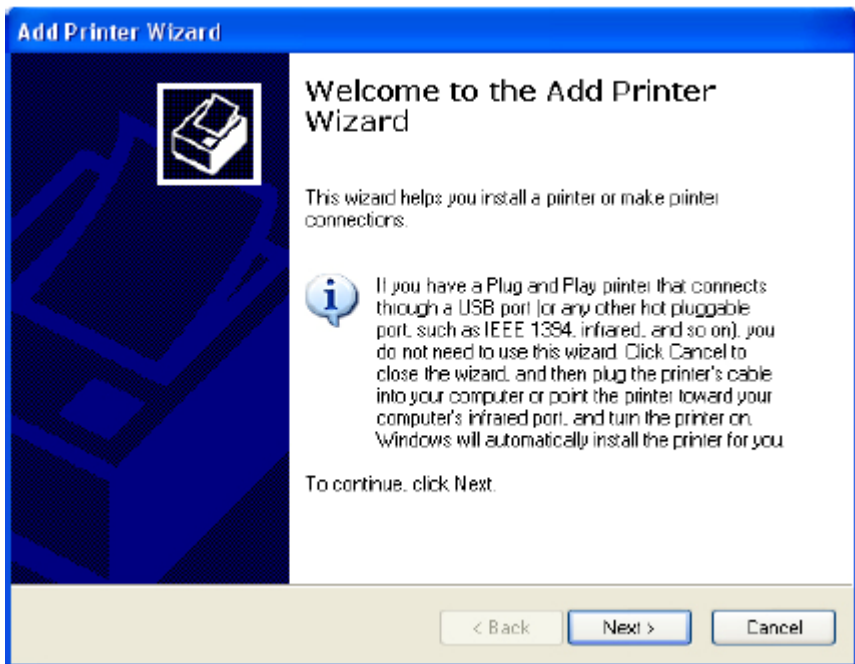

Select the first option, **Local printer attached to this computer**, and click **Next**.

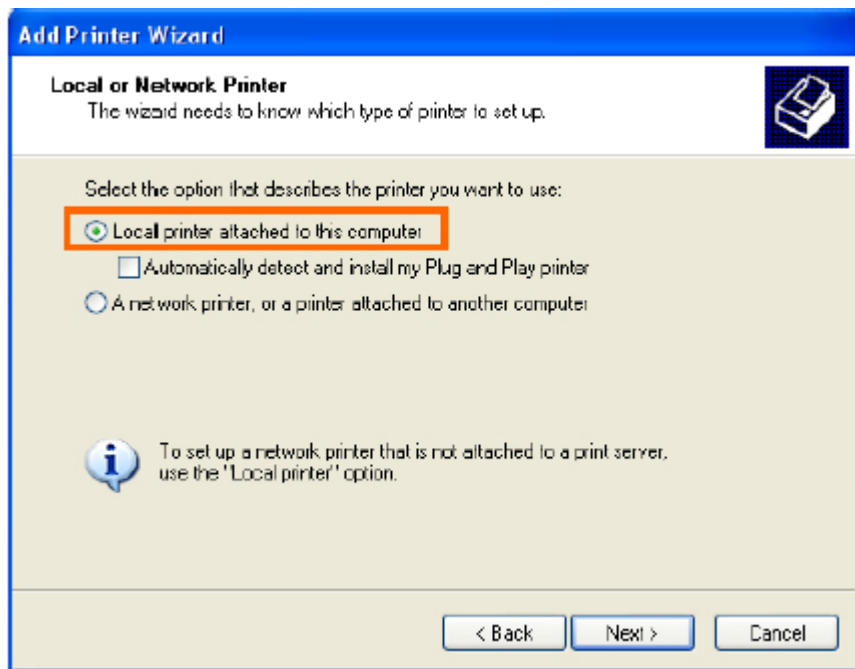

Click the second option, **Create a new port**, and select **Standard TCP/IP Port** from the drop-down list box. Click **Next**.

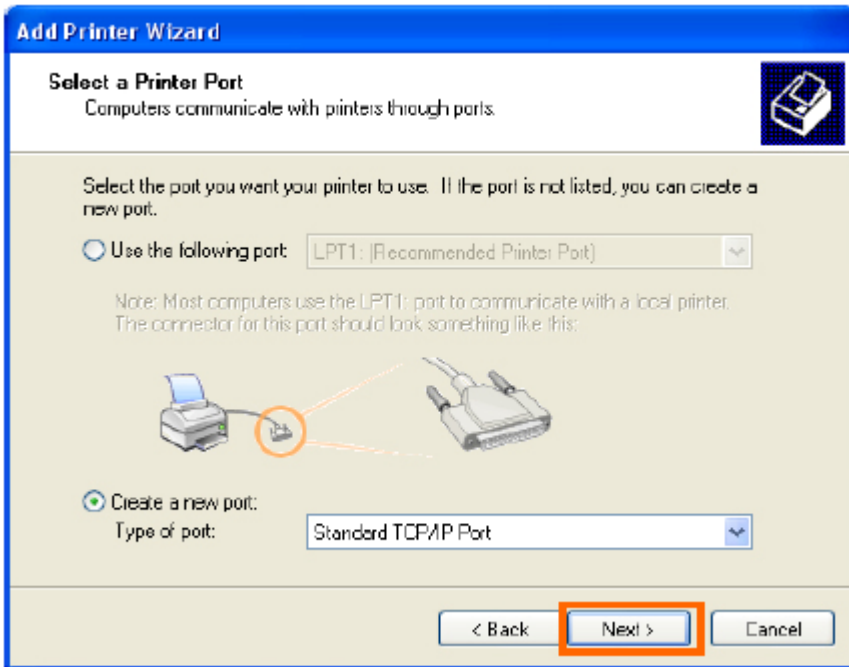

Click **Next**.

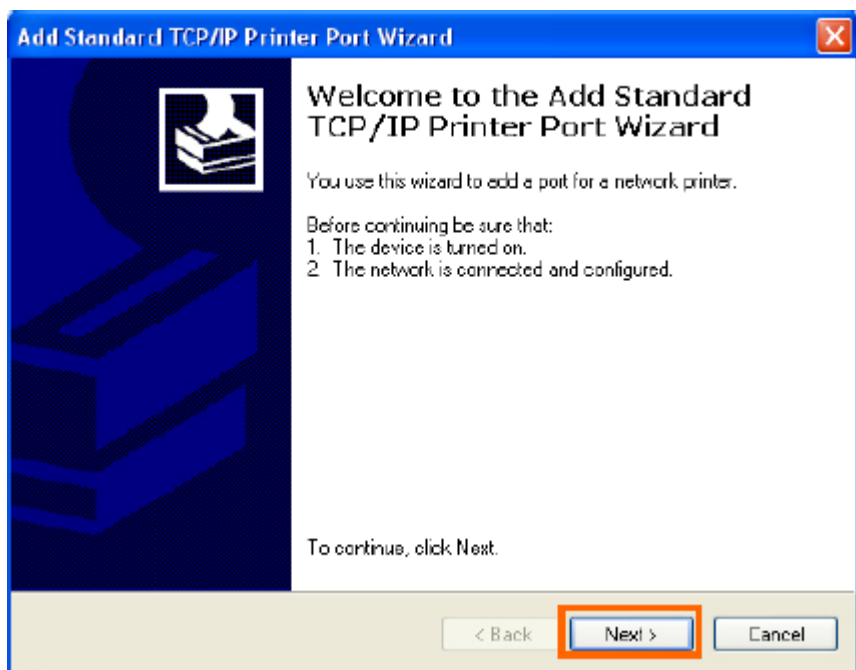

In the **Hostname or IP address field**, type the IP address of the MFP server (e.g. 10.62.31.15), this address can be found in the **PRINTER SERVER STATUS** screen of the MFP server's web configurator. The **Port Name** field will automatically fill in. Click **Next**.

Add Standard TCP/IP Printer Port Wizard



Add Port
For which device do you want to add a port?

Enter the Printer Name or IP address, and a port name for the desired device.

Printer Name or IP Address: 10.62.31.15

Port Name: IP_10.62.31.15

< Back Next > Cancel

Product: DPR-1040		Firmware Version: A.0B			
D-Link					
DPR-1040	Setup	Advanced	Maintenance	Status	Help
Device Info	DEVICE INFO				Helpful Hints.. Print Server Status: The information about the print server, including the print server, including the firmware version, and MAC/IP address, can be found in this field. Printer Status: The items in this field display the information of the printer, such as the given name for the printer, speed, and printer status. LPR Status:
Network	The following shows the general system information.				
Wireless	PRINT SERVER STATUS				
 Printer  Off line Reboot	Server Name : dlink-234567 Model : DPR-1040 Firmware Version : A.0B (2008-11-21) MAC Address : 00 C0 02 23 45 67 IP Address : 192.168.0.10 (DHCP)				

Select **Custom** and click **Settings**.

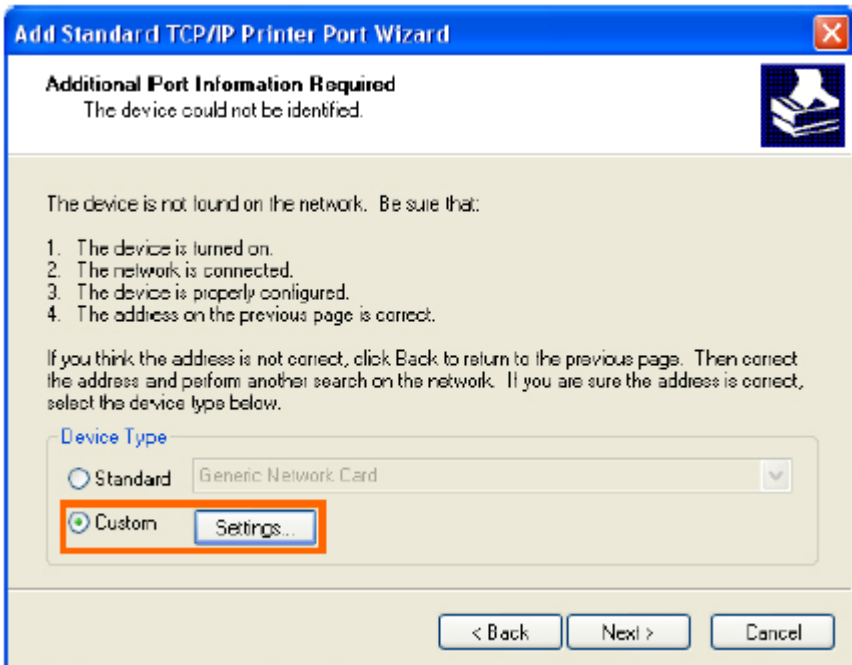

The following screen will display, select **LPR** from the **Protocol** field.

Enter the **Queue Name**, which can be found in the **PRINTER STATUS** screen of the MFP server's web configurator. Click **OK**.

Configure Standard TCP/IP Port Monitor

Port Settings

Port Name: IP_10.62.31.15

Printer Name or IP Address: 10.62.31.15

Protocol

Raw LPR

Raw Settings

Port Number: 515

LPR Settings

Queue Name: dlk-812AFA-U1

LPR Byte Counting Enabled

SNMP Status Enabled

Community Name: public

SNMP Device Index: 1

OK Cancel



DPR-1040	Setup	Advanced	Maintenance	Status	Help
<p>Device Info</p> <p>Network</p> <p>Wireless</p> <p> Printer Off line</p> <p>Reboot</p>	<p>DEVICE INFO</p> <p>The following shows the general system information.</p> <hr/> <p>PRINT SERVER STATUS</p> <p>Server Name : DLINK-234567 Model : DPR-1040 Firmware Version : A.0B (2008-11-21) MAC Address : 00 C0 02 23 45 67 IP Address : 192.168.0.10 (DHCP)</p> <hr/> <p>PRINTER STATUS</p> <p>USB : <input type="text" value="Printer Name"/> : Printer Speed : Printer Status : Offline</p>				<p>Helpful Hints..</p> <p>Print Server Status: The information about the print server, including the firmware version, and MAC/IP address, can be found in this field.</p> <p>Printer Status: The items in this field display the information of the printer, such as the given name for the printer, speed, and printer status.</p> <p>LAN Status: You can monitor the networking status in this field, including the network connection and speed.</p>

Click **Next**.

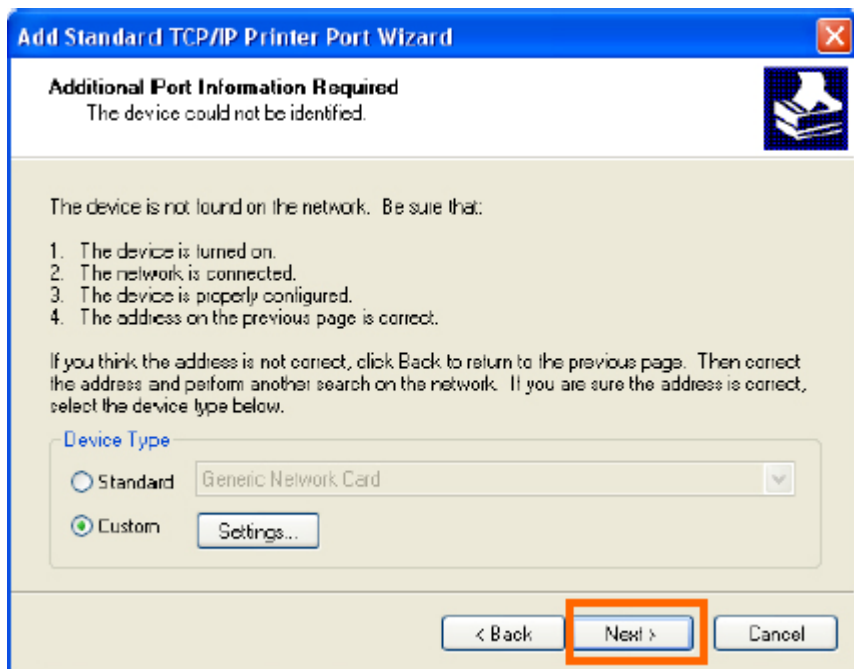

Click **Finish**.

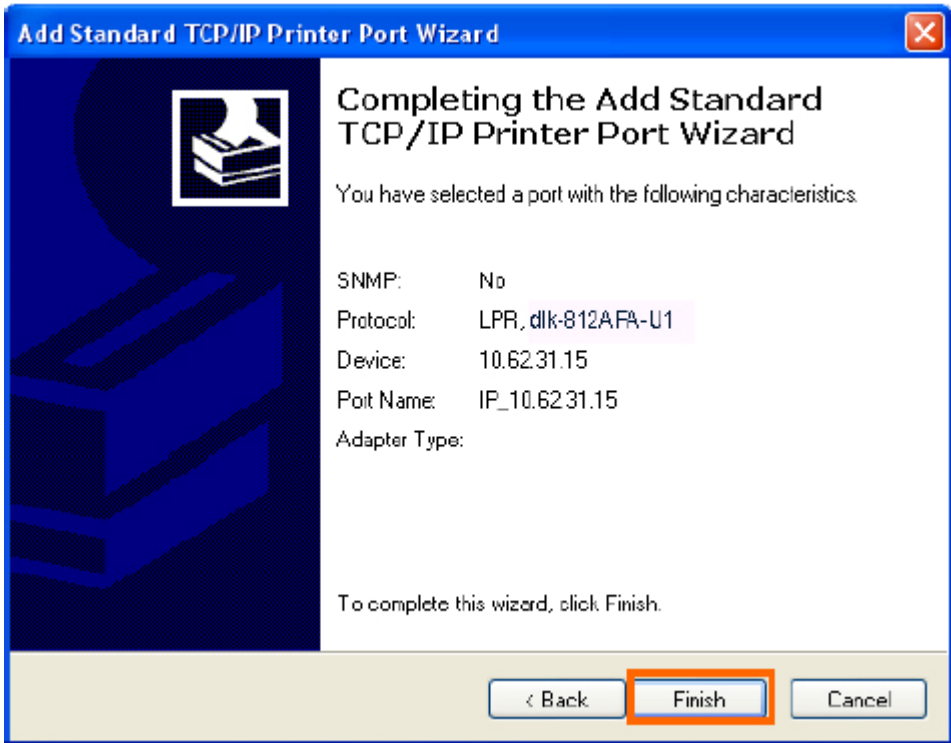

In the next screen highlight the printer you wish to add. If the printer is not on the list, click [**Have Disk**] and insert the printer driver disk that came with your printer to install the printer drivers.

Click **Next**.

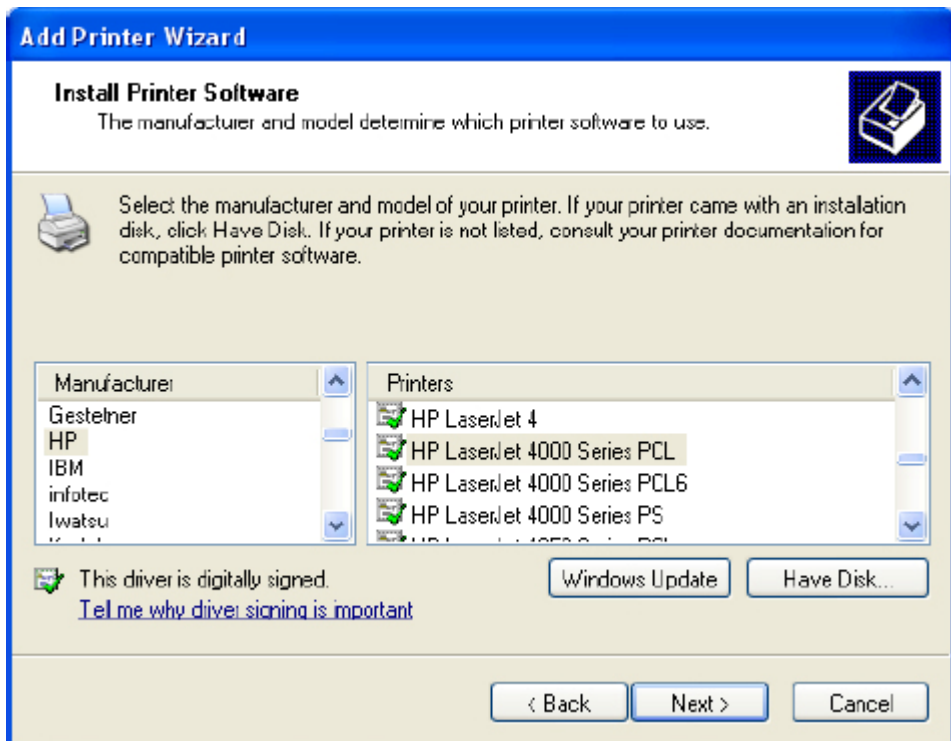

At this screen, you can input a name for the printer, and then click **Next**.

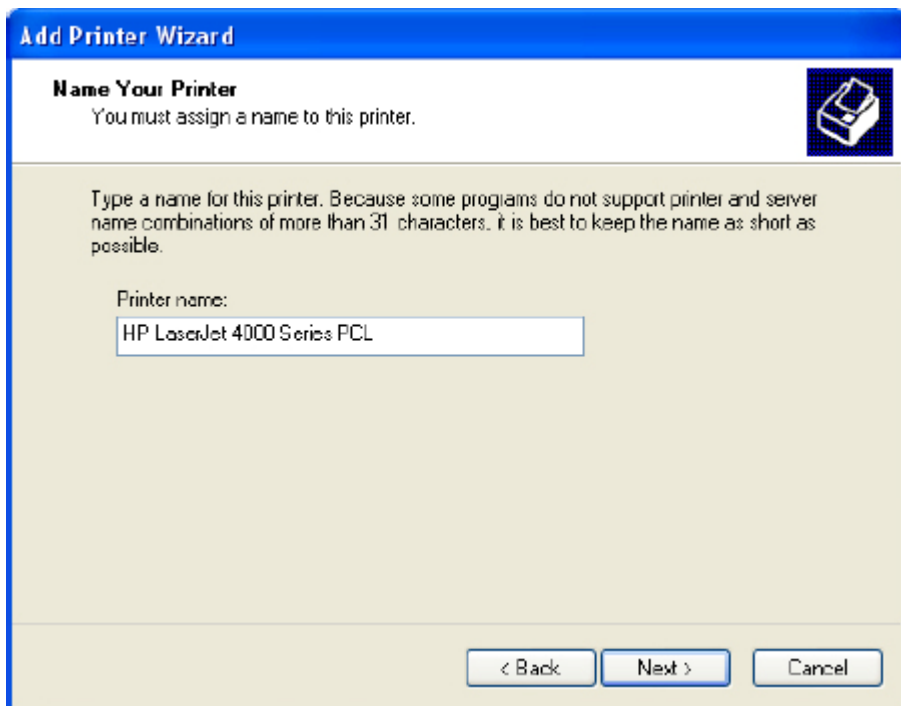

Select Yes to print a test page, click **Next**.

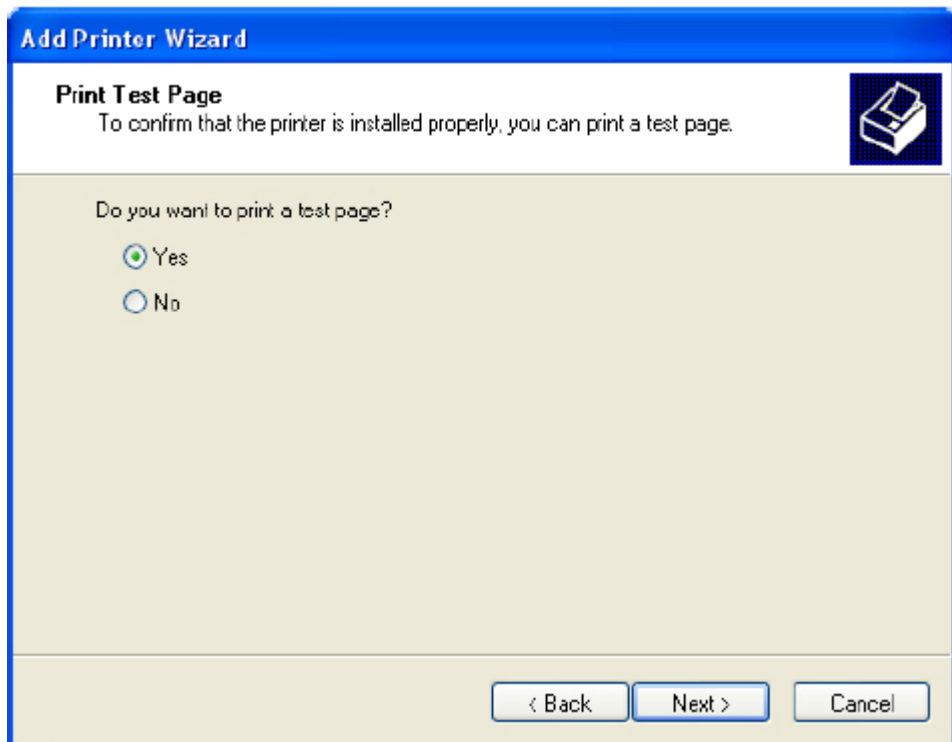

Click **Finish**. The printer is now ready for use.

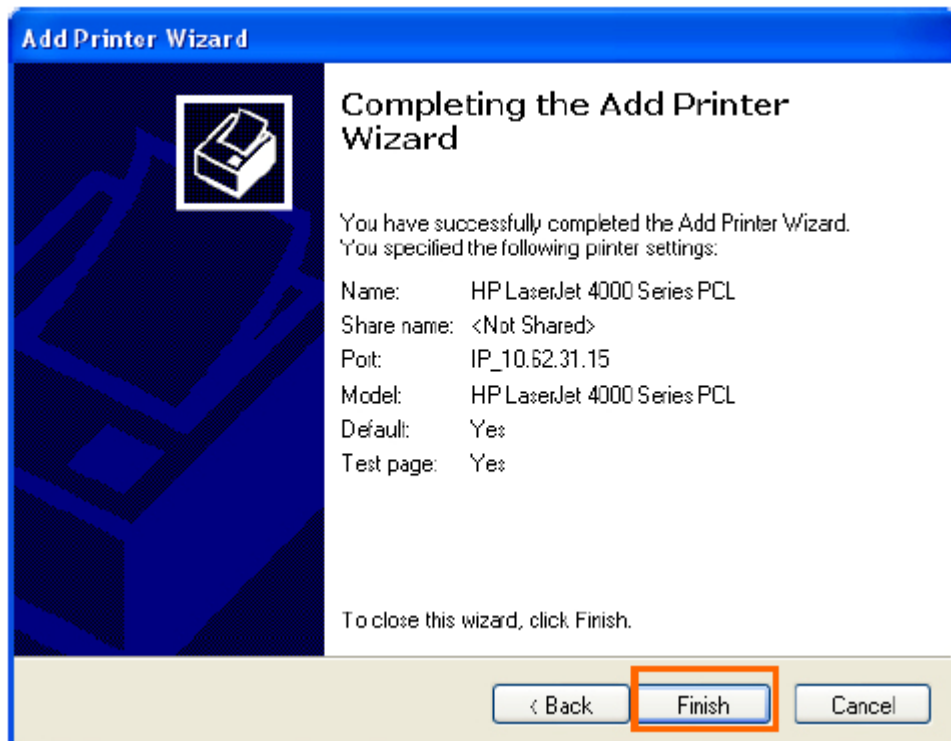

TCP/IP Printing for Windows 2000

Go to **Start > Settings > Printers and Faxes > Add a Printer**.



When the following screen shows up, click **Next**.

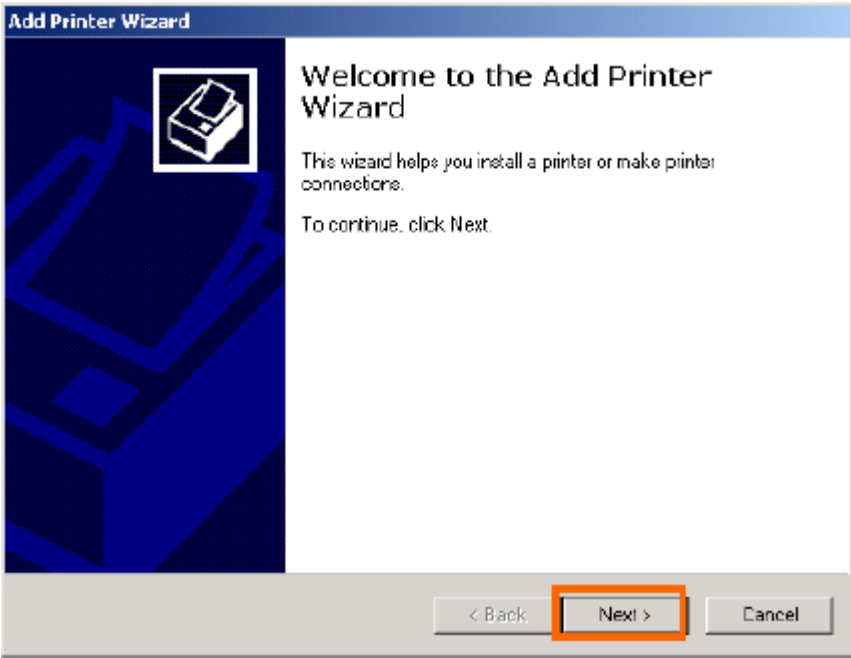

Select the first option, **Local printer**, and click **Next**.

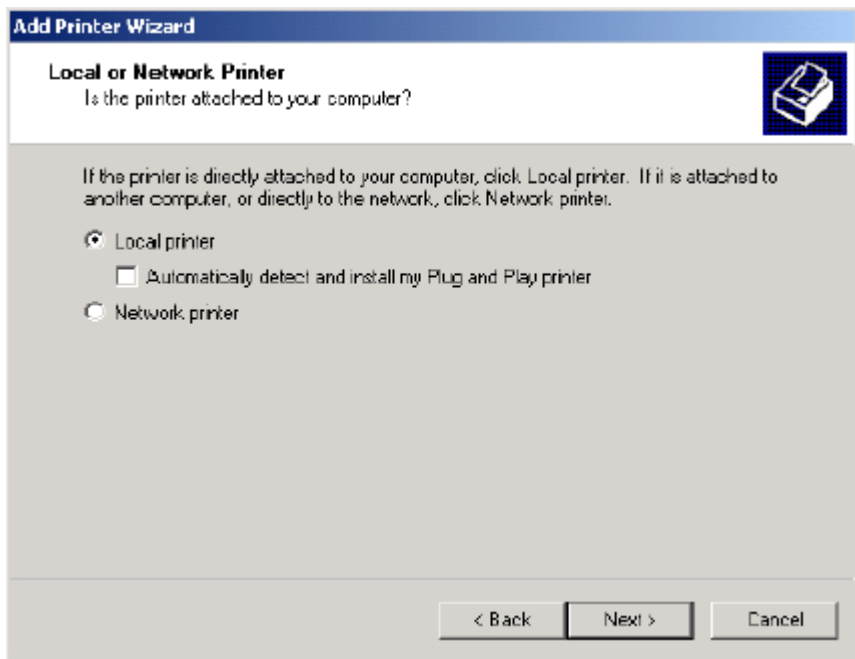

Click **Next** if the New Printer Detection screen pops up.

On the next screen, select the second option **Create a new port** and highlight **Standard TCP/IP Port** from the drop-down list. Click **Next**.

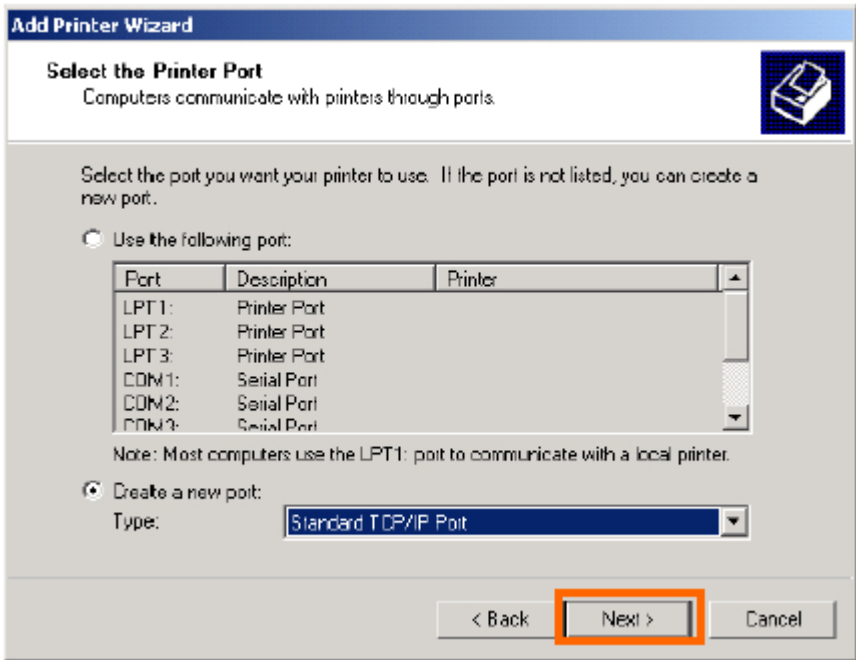

Click **Next**.

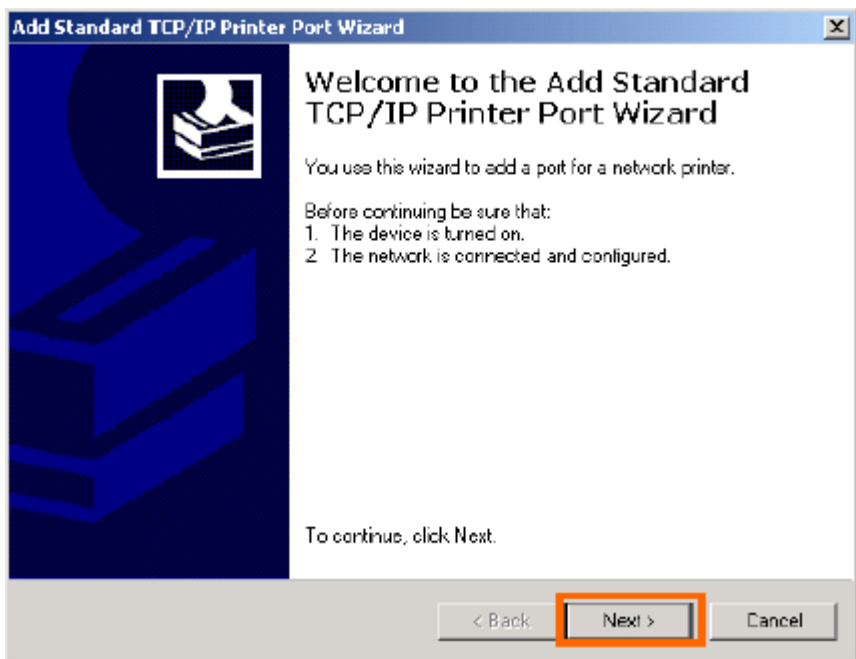

In the **Hostname or IP address field**, type the IP address of the MFP server (e.g. 10.62.31.15), this address can be found in the **PRINTER SERVER STATUS** screen of the MFP server's web configurator. The **Port Name** field will automatically fill in. Click **Next**.

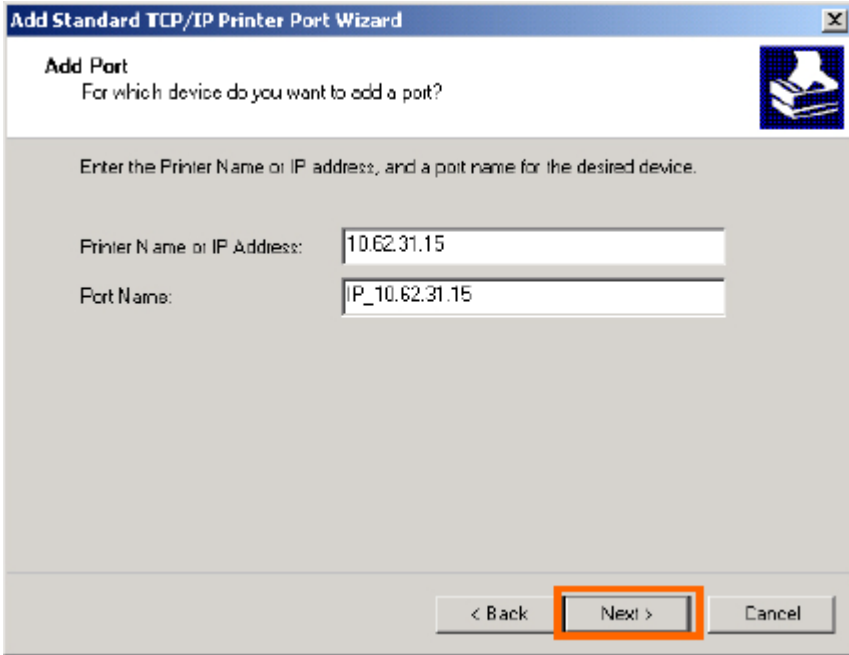

Product: DPR-1040 Firmware Version: A.0B

D-Link

DPR-1040 // **Setup** Advanced Maintenance **Status** Help

Device Info	DEVICE INFO	Helpful Hints.. Print Server Status: The information about the print server, including the print server, including the firmware version, and MAC/IP address, can be found in this field. Printer Status: The items in this field display the information of the printer, such as the given name for the printer, speed, and printer status. <small>LPR Status:</small>
Network	The following shows the general system information.	
Wireless	PRINT SERVER STATUS Server Name : dlink-234567 Model : DPR-1040 Firmware Version : A.0B (2008-11-21) MAC Address : 00 C0 02 23 45 67 IP Address : 192.168.0.10 (DHCP)	

Printer Off line
 Reboot

Select **Custom** and click **Settings**.

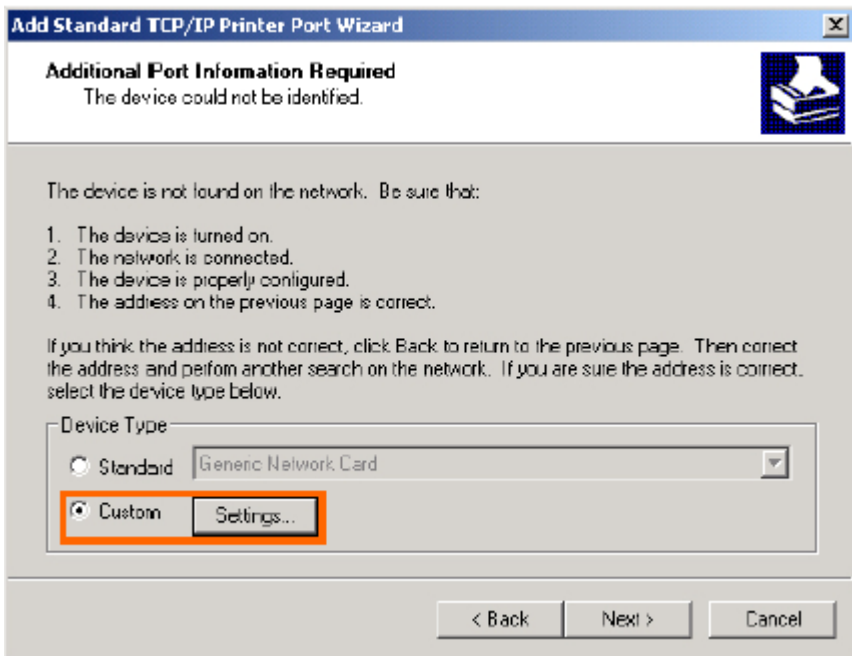

The following screen will display, select **LPR** from the **Protocol** field.

Enter the **Queue Name**, which can be found in the **PRINTER STATUS** screen of the MFP server's web configurator. Click **OK**.

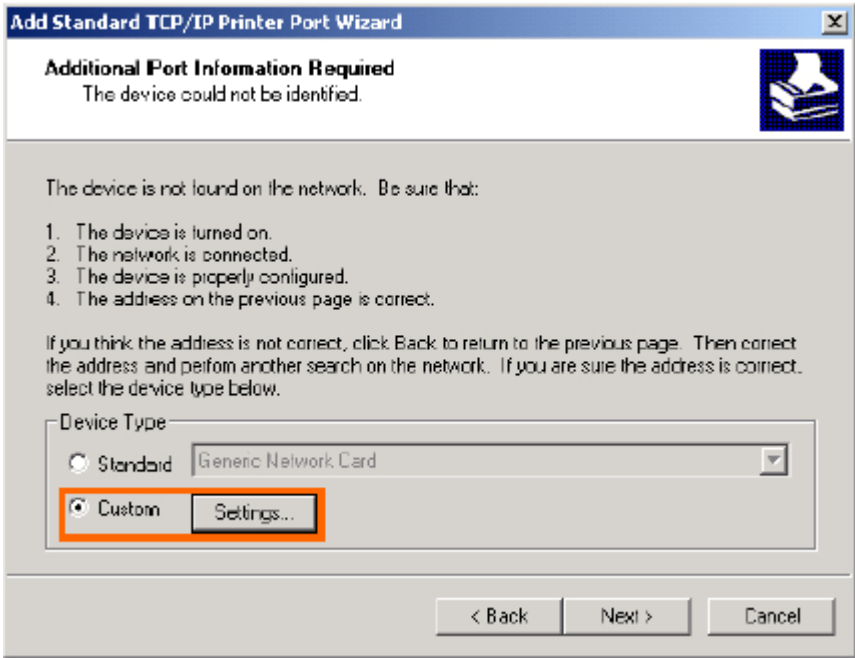

Product: DPR-1040 Firmware Version: A.0B

D-Link

DPR-1040	Setup	Advanced	Maintenance	Status	Help
Device Info Network Wireless  Reboot	<div style="background-color: #f4a460; padding: 5px;">DEVICE INFO</div> <p>The following shows the general system information.</p> <div style="border: 1px solid black; padding: 5px; margin-top: 10px;"> <p>PRINT SERVER STATUS</p> <p>Server Name : DLINK-234567 Model : DPR-1040 Firmware Version : A.0B (2008-11-21) MAC Address : 00 C0 02 23 45 67 IP Address : 192.168.0.10 (DHCP)</p> </div> <div style="border: 1px solid black; padding: 5px; margin-top: 10px;"> <p>PRINTER STATUS</p> <p>USB : Printer Name : Printer Speed : Printer Status : Offline</p> </div>				Helpful Hints.. <p>Print Server Status: The information about the print server, including the firmware version, and MAC/IP address, can be found in this field.</p> <p>Printer Status: The items in this field display the information of the printer, such as the given name for the printer, speed, and printer status.</p> <p>LAN Status: You can monitor the networking status in this field, including the network connection and speed.</p>

Click **Finish**.

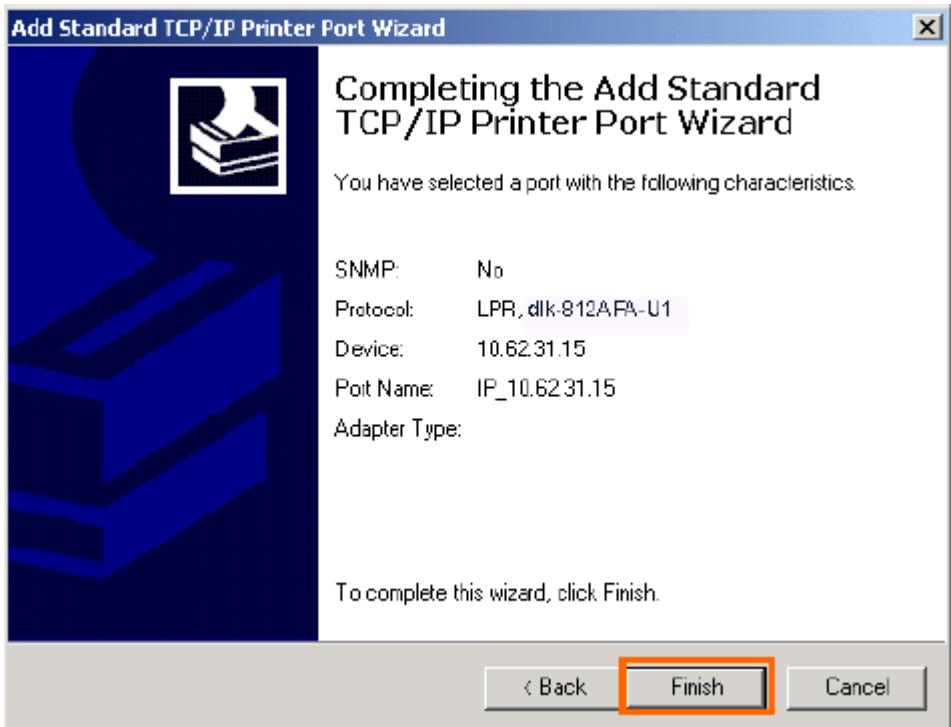

In the next screen highlight the printer you wish to add. If the printer is not on the list, click **[Have Disk]** and insert the printer driver disk that came with your printer to install the printer drivers.

Click **Next**.

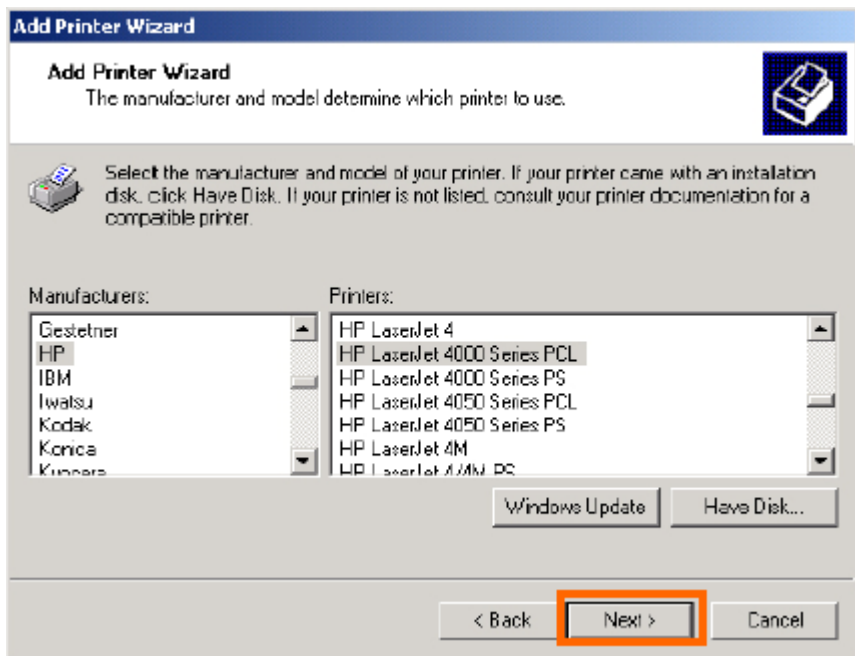

At this screen, input a name for the printer, and then click **Next >**.

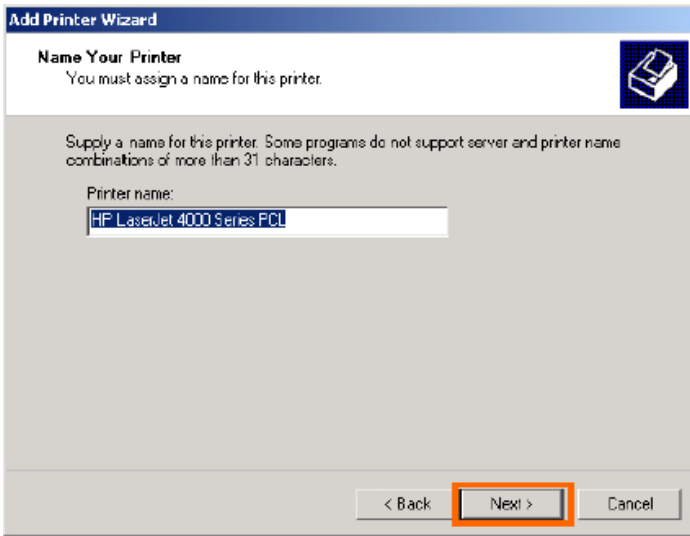

Select the first option, **Do not share this printer**, and click **Next**.

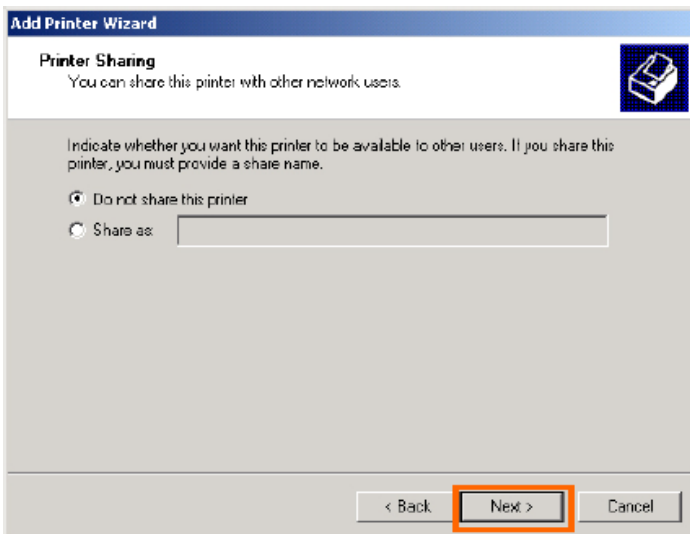

Select Yes to print a test page, click **Next**.

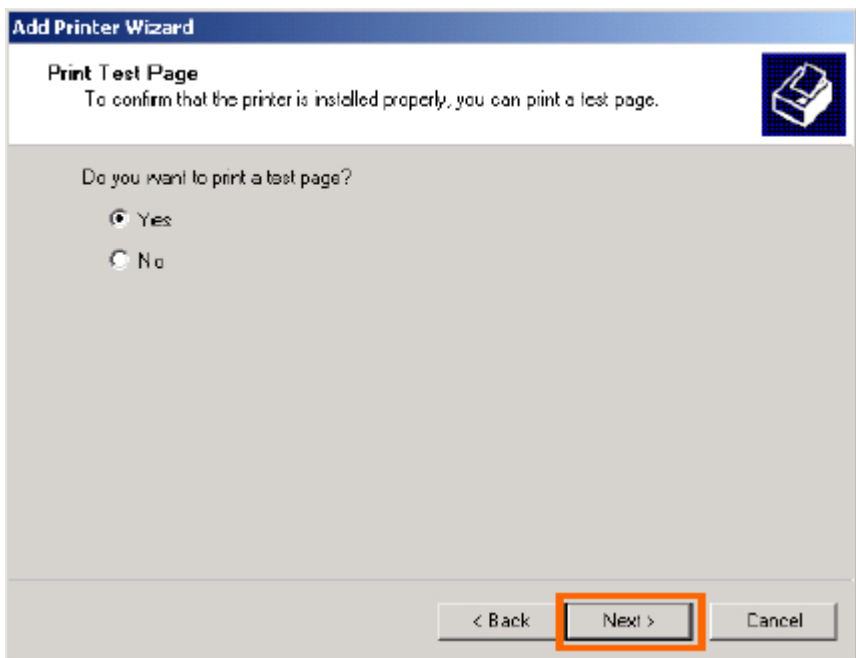

Click **Finish**. The printer is now ready for printing with Windows 2000 on your network.

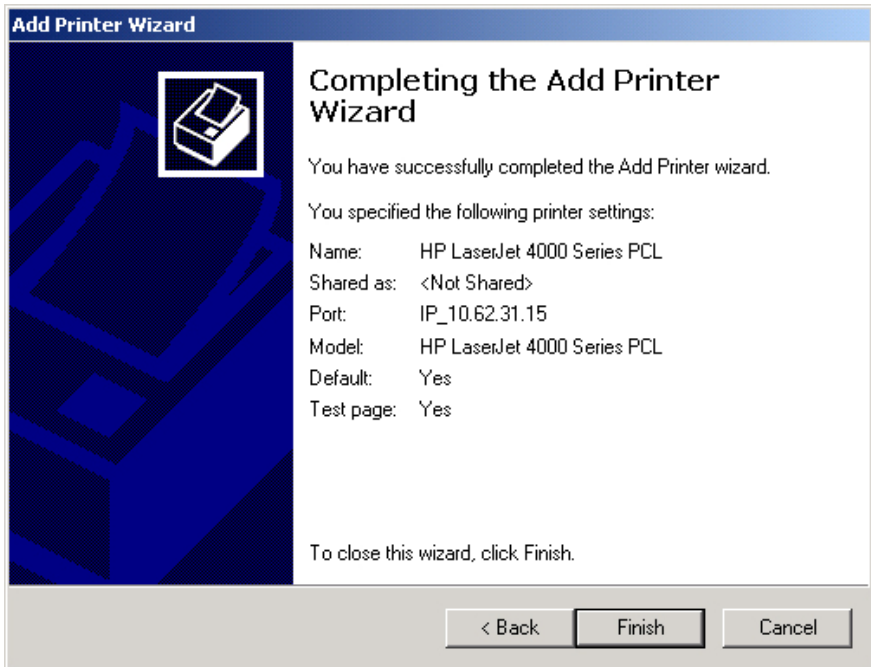

Setting up Printing in Mac OS X Tiger (10.4.9)

NOTE: Mac OS printing is supported by Postscript printers only!

With Mac OS X Tiger (10.4), you can use Line Printer Daemon (LPD) printing through the Print Server.

Adding a Printer

Use the **Go** menu at the top tool bar and select **Applications** option and find the **Utilities** folder or open the **Utilities** folder directly in **Go** menu.

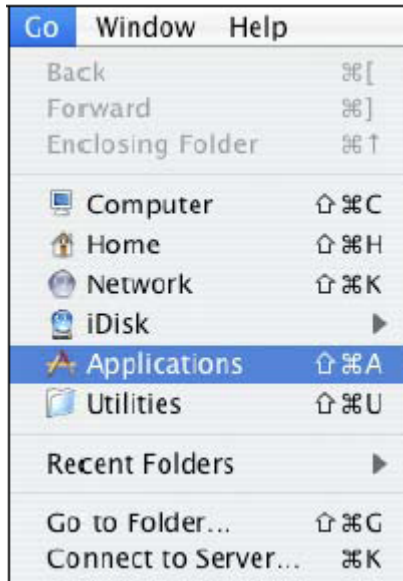

In the **Utilities** folder, find and select  **Printer Setup Utility** to see the **Printer List** dialog window.

Setting up Printing in Mac OS X Tiger (10.4.9)

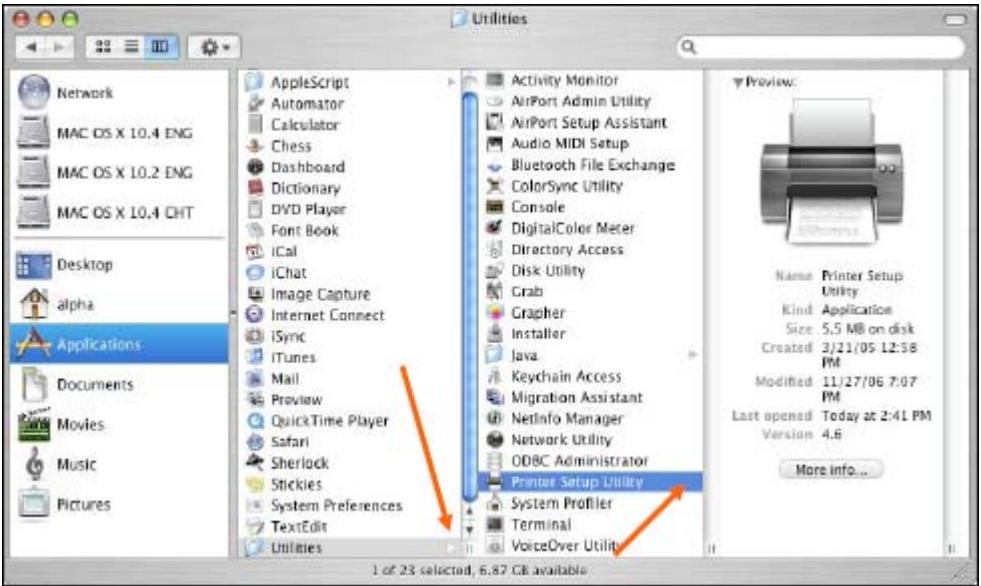

Click **Add** button to open **Printer Browser** window.

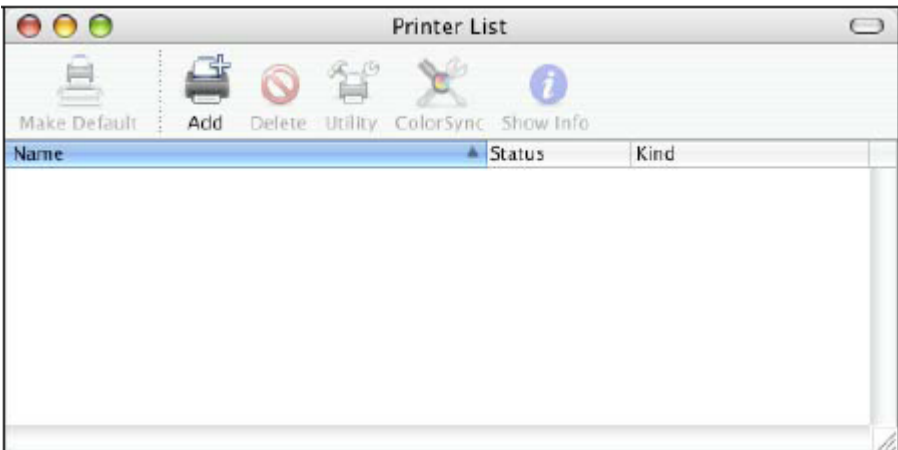

Mac OS X Tiger (10.4) supports one printing protocol:

1. Line Printer Daemon (LPD)

To set up LPD Printing

1. Enter the IP address of the print server to which the printer is attached in **Address** field.
2. Type the port name in the **Queue** field.

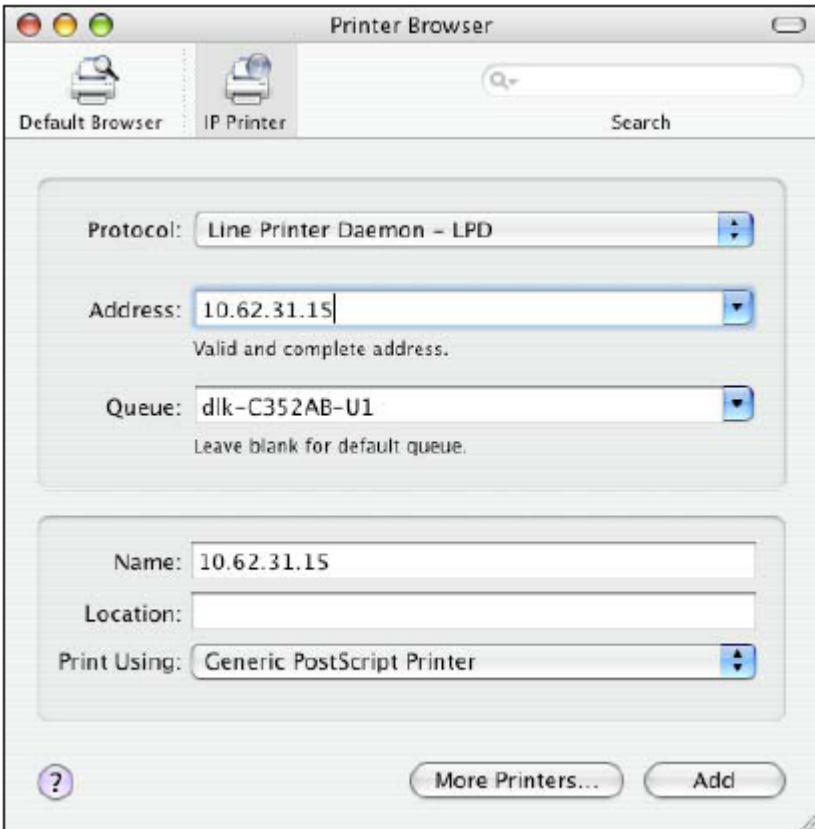

Click the **Add** button after selecting the printer model in the **Print Using** drop-down menu.

Set up Socket Printing

1. Enter the IP address of the print server to which the printer is attached in **Address** field. After that, type “: 9100” for port 1.
2. Keep the **Queue** field blank.

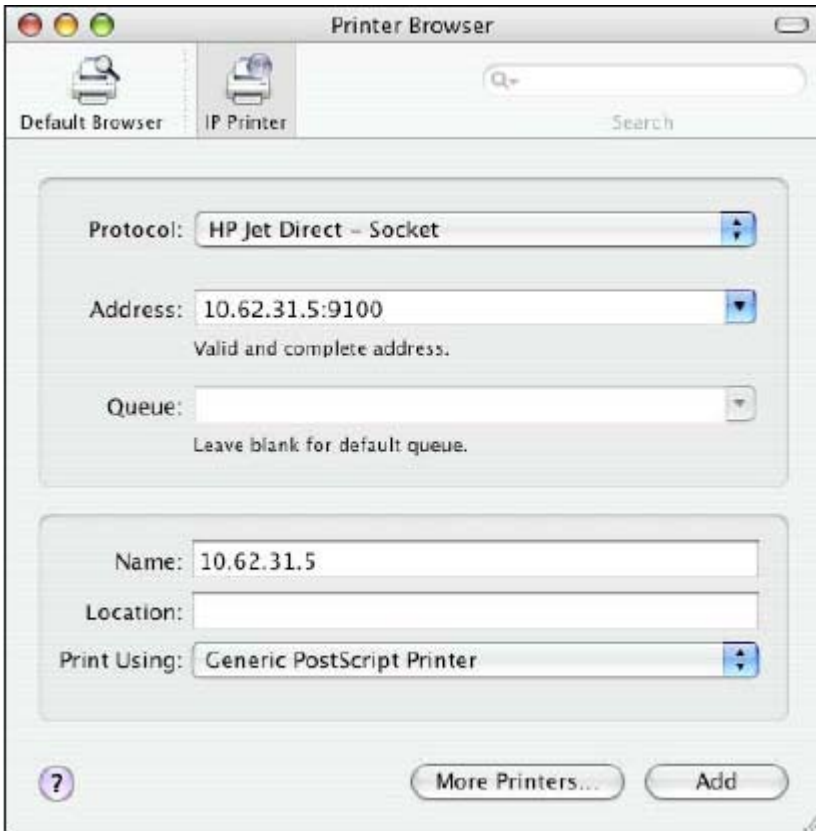

Click the **Add** button after selecting the printer model in the **Print Using** drop-down menu.

When the **Installable Options** screen is displayed as below, click the **Continue** button.

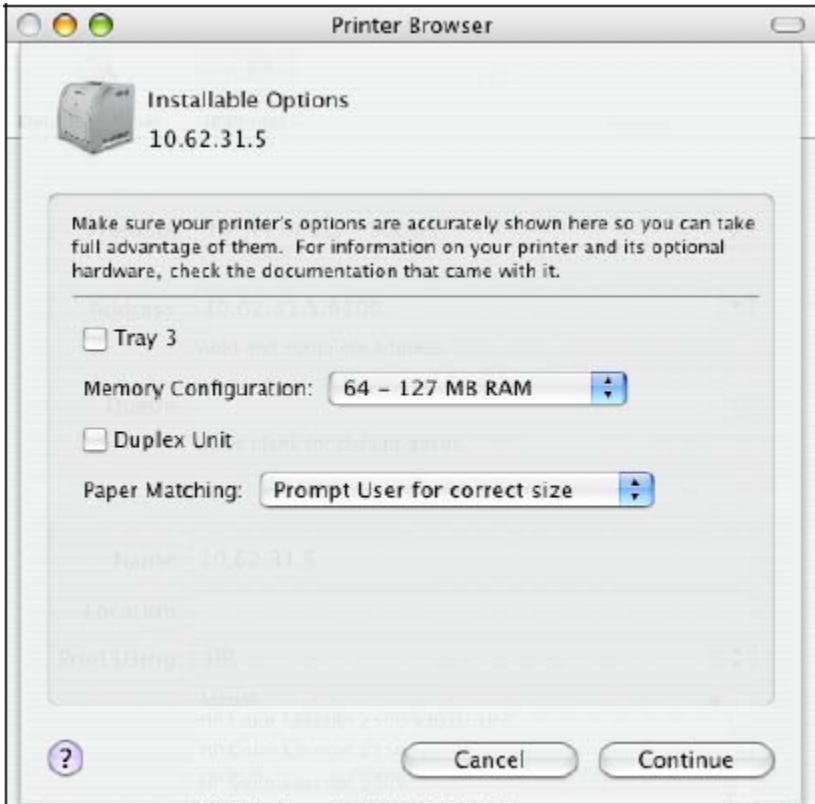

Setting up Printing in Mac OS X Tiger (10.4.9)

The printer that has just been added will show up in the **Printer List** menu, it might take a few seconds depending on network conditions. When the printer appears listed it is ready for use. Quit the **Printer Setup Utility** and start printing.

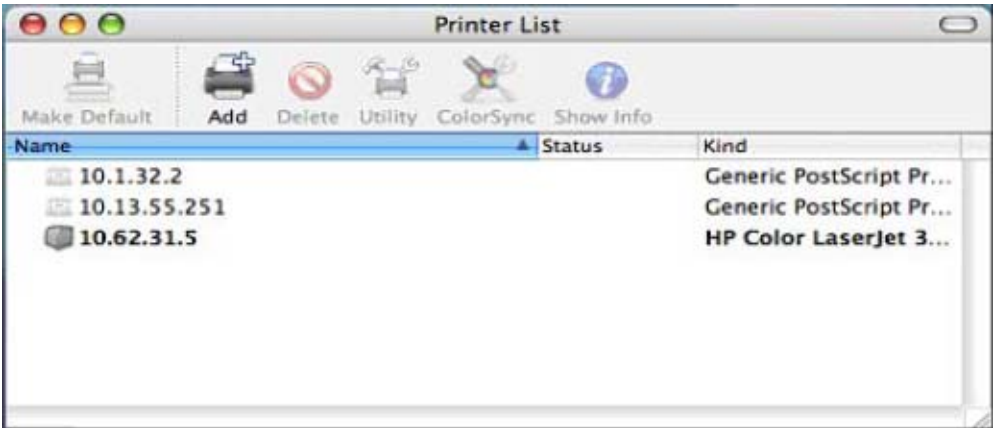

Technical Specifications

Printer Connection

Printer Port: USB 2.0

Bi-directional Communication: Hewlett-Packard PJP (Printer Job Language) standard for bi-directional communication.

Network Connection

Network Standards: 100Base-TX Fast Ethernet, 802.11b/g Wireless Standard

Network Data Transfer Rate: 10/100 Mbps (megabits per second), Up to 54Mbps

Network Interfaces: RJ-45, 802.11b/g wireless LAN

Wireless Security: 64/128 bit WEP, WPA/WPA2, WPS support

Network Protocols

Ethernet Frame Types: 802.2, 802.3, Ethernet II, SNAP (auto-switching)

Transport Protocols: TCP/IP, LPR, RAW, IPP

TCP/IP Protocols Supported: BOOTP, LPD, RARP, DHCP, IPP

Management and Diagnostics

Diagnostic LED Indicators: Power, USB, LAN, Wireless

Environmental and Physical

Power Supply: External power supply providing 5V, 1.2A DC

Dimensions: 67(W) x 25(H) x 106(D)mm

Weight: approx. 2.88 oz. (82g)

Operating Temperature: 32 to 104 °F (0 to 40°C)

Storage Temperature: -13 to 131°F (-25 to 55 °C)

Humidity: 5% to 95% non-condensing

Emissions: FCC Class B, CA IC RF, CE Class B, UL/c-UL, AU A-Tick, NCC

Contacting Technical Support

Technical Support

You can find software updates and user documentation on the D-Link website.

D-Link provides free technical support for customers within the United States and within Canada for the duration of the warranty period on this product.

U.S. and Canadian customers can contact D-Link technical support through our website, or by phone.

Tech Support for customers within the United States:

D-Link Technical Support over the Telephone:

(877) 453-5465

24 hours a day, seven days a week.

D-Link Technical Support over the Internet:

<http://support.dlink.com>

email: support@dlink.com

Tech Support for customers within Canada:

D-Link Technical Support over the Telephone:

(800) 361-5265

Monday to Friday 8:30am to 9:00pm EST

D-Link Technical Support over the Internet:

<http://support.dlink.ca>

email: support@dlink.ca

When contacting technical support, please provide the following information:

- *Serial number of the unit*
- *Model number or product name*
- *Software type and version number*

Warranty and Registration

Subject to the terms and conditions set forth herein, D-Link Systems, Inc. (—D-Link“) provides this Limited warranty for its product only to the person or entity that originally purchased the product from:

- D-Link or its authorized reseller or distributor and
- Products purchased and delivered within the fifty states of the United States, the District of Columbia, U.S. Possessions or Protectorates, U.S. Military Installations, addresses with an APO or FPO.

Limited Warranty: D-Link warrants that the hardware portion of the D-Link products described below will be free from material defects in workmanship and materials from the date of original retail purchase of the product, for the period set forth below applicable to the product type (—Warranty Period“), except as otherwise stated herein.

1-Year Limited Warranty for the Product(s) is defined as follows:

- Hardware (excluding power supplies and fans) One (1) Year
- Power Supplies and Fans One (1) Year
- Spare parts and spare kits ninety (90) days.

D-Link’s sole obligation shall be to repair or replace the defective Hardware during the Warranty Period at no charge to the original owner or to refund at D-Link’s sole discretion. Such repair or replacement will be rendered by D-Link at an Authorized D-Link Service Office. The replacement Hardware need not be new or have an identical make, model or part. D-Link may in its sole discretion replace the defective Hardware (or any part thereof) with any reconditioned product that D-Link reasonably determines is substantially equivalent (or superior) in all material respects to the defective Hardware. Repaired or replacement Hardware will be warranted for the remainder of the original Warranty Period from the date of original retail purchase. If a material defect is incapable of correction, or if D-Link determines in its sole discretion that it is not practical to repair or replace the defective Hardware, the price paid by the original purchaser for the defective Hardware will be refunded by D-Link upon return to D-Link of the defective Hardware. All Hardware (or part thereof) that is replaced by D-Link, or for which the purchase price is refunded, shall

Warranty and Registration

become the property of D-Link upon replacement or refund.

Limited Software Warranty: D-Link warrants that the software portion of the product (“Software”) will substantially conform to D-Link’s then current functional specifications for the Software, as set forth in the applicable documentation, from the date of original retail purchase of the Software for a period of ninety (90) days (“Warranty Period”), provided that the Software is properly installed on approved hardware and operated as contemplated in its documentation. D-Link further warrants that, during the Warranty Period, the magnetic media on which D-Link delivers the Software will be free of physical defects. D-Link’s sole obligation shall be to replace the non-conforming Software (or defective media) with software that substantially conforms to D-Link’s functional specifications for the Software or to refund at D-Link’s sole discretion. Except as otherwise agreed by D-Link in writing, the replacement Software is provided only to the original licensee, and is subject to the terms and conditions of the license granted by D-Link for the Software. Software will be warranted for the remainder of the original Warranty Period from the date of original retail purchase. If a material non-conformance is incapable of correction, or if D-Link determines in its sole discretion that it is not practical to replace the non-conforming Software, the price paid by the original licensee for the non-conforming Software will be refunded by D-Link; provided that the non-conforming Software (and all copies thereof) is first returned to D-Link. The license granted respecting any Software for which a refund is given automatically terminates.

Non-Applicability of Warranty: The Limited Warranty provided hereunder for hardware and software of D-Link’s products will not be applied to and does not cover any refurbished product and any product purchased through the inventory clearance or liquidation sale or other sales in which D-Link, the sellers, or the liquidators expressly disclaim their warranty obligation pertaining to the product and in that case, the product is being sold “As-Is” without any warranty whatsoever including, without limitation, the Limited Warranty as described herein, notwithstanding anything stated herein to the contrary.

Submitting A Claim: The customer shall return the product to the original purchase point based on its return policy. In case the return policy period has expired and the product is within warranty, the customer shall submit a claim to D-Link as outlined below:

- The customer must submit with the product as part of the claim a written description of the Hardware defect or Software nonconformance in sufficient detail to allow D-Link to confirm the

Warranty and Registration

same.

□ The original product owner must obtain a Return Material Authorization (—RMA“) number from the Authorized D-Link Service Office and, if requested, provide written proof of purchase of the product (such as a copy of the dated purchase invoice for the product) before the warranty service is provided.

□ After an RMA number is issued, the defective product must be packaged securely in the original or other suitable shipping package to ensure that it will not be damaged in transit, and the RMA number must be prominently marked on the outside of the package. Do not include any manuals or accessories in the shipping package. D-Link will only replace the defective portion of the Product and will not ship back any accessories.

□ The customer is responsible for all in-bound shipping charges to D-Link. No Cash on Delivery (—COD“) is allowed. Products sent COD will either be rejected by D-Link or become the property of D-Link. Products shall be fully insured by the customer and shipped to D-Link Systems, Inc., 53 Discovery Drive, Irvine, CA 92618. D-Link will not be held responsible for any packages that are lost in transit to D-Link. The repaired or replaced packages will be shipped to the customer via UPS Ground or any common carrier selected by D-Link, with shipping charges prepaid. Expedited shipping is available if shipping charges are prepaid by the customer and upon request.

D-Link may reject or return any product that is not packaged and shipped in strict compliance with the foregoing requirements, or for which an RMA number is not visible from the outside of the package. The product owner agrees to pay D-Link's reasonable handling and return shipping charges for any product that is not packaged and shipped in accordance with the foregoing requirements, or that is determined by D-Link not to be defective or non-conforming.

What Is Not Covered: This limited warranty provided by D-Link does not cover: Products, if in D-Link's judgment, have been subjected to abuse, accident, alteration, modification, tampering, negligence, misuse, faulty installation, lack of reasonable care, repair or service in any way that is not contemplated in the documentation for the product, or if the model or serial number has been altered, tampered with, defaced or removed; Initial installation, installation and removal of the product for repair, and shipping

Warranty and Registration

costs; Operational adjustments covered in the operating manual for the product, and normal maintenance;

Damage that occurs in shipment, due to act of God, failures due to power surge, and cosmetic damage;

Any hardware, software, firmware or other products or services provided by anyone other than D-Link;

Products that have been purchased from inventory clearance or liquidation sales or other sales in which D-Link, the sellers, or the liquidators expressly disclaim their warranty obligation pertaining to the product.

Repair by anyone other than D-Link or an Authorized D-Link Service Office will void this Warranty.

Disclaimer of Other Warranties: EXCEPT FOR THE LIMITED WARRANTY SPECIFIED HEREIN, THE PRODUCT IS PROVIDED —AS-IS“ WITHOUT ANY WARRANTY OF ANY KIND WHATSOEVER INCLUDING, WITHOUT LIMITATION, ANY WARRANTY OF MERCHANTABILITY, FITNESS FOR A PARTICULAR PURPOSE AND NON-INFRINGEMENT. IF ANY IMPLIED WARRANTY CANNOT BE DISCLAIMED IN ANY TERRITORY WHERE A PRODUCT IS SOLD, THE DURATION OF SUCH IMPLIED WARRANTY SHALL BE LIMITED TO NINETY (90) DAYS. EXCEPT AS EXPRESSLY

183

COVERED UNDER THE LIMITED WARRANTY PROVIDED HEREIN, THE ENTIRE RISK AS TO THE QUALITY, SELECTION AND PERFORMANCE OF THE PRODUCT IS WITH THE PURCHASER OF THE PRODUCT.

Limitation of Liability: TO THE MAXIMUM EXTENT PERMITTED BY LAW, D-LINK IS NOT LIABLE UNDER ANY CONTRACT, NEGLIGENCE, STRICT LIABILITY OR OTHER LEGAL OR EQUITABLE THEORY FOR ANY LOSS OF USE OF THE PRODUCT, INCONVENIENCE OR DAMAGES OF ANY CHARACTER, WHETHER DIRECT, SPECIAL, INCIDENTAL OR CONSEQUENTIAL (INCLUDING, BUT NOT LIMITED TO, DAMAGES FOR LOSS OF GOODWILL, LOSS OF REVENUE OR PROFIT, WORK STOPPAGE, COMPUTER FAILURE OR MALFUNCTION, FAILURE OF OTHER EQUIPMENT OR COMPUTER PROGRAMS TO WHICH D-LINK'S PRODUCT IS CONNECTED WITH, LOSS OF INFORMATION OR DATA CONTAINED IN, STORED ON, OR INTEGRATED WITH ANY PRODUCT RETURNED TO D-LINK FOR WARRANTY SERVICE) RESULTING FROM THE USE OF THE PRODUCT, RELATING TO WARRANTY SERVICE, OR ARISING OUT OF ANY BREACH OF THIS LIMITED WARRANTY, EVEN IF D-LINK HAS BEEN ADVISED OF THE POSSIBILITY OF SUCH

Warranty and Registration

DAMAGES. THE SOLE REMEDY FOR A BREACH OF THE FOREGOING LIMITED WARRANTY IS REPAIR, REPLACEMENT OR REFUND OF THE DEFECTIVE OR NON-CONFORMING PRODUCT. THE MAXIMUM LIABILITY OF D-LINK UNDER THIS WARRANTY IS LIMITED TO THE PURCHASE PRICE OF THE PRODUCT COVERED BY THE WARRANTY. THE FOREGOING EXPRESS WRITTEN WARRANTIES AND REMEDIES ARE EXCLUSIVE AND ARE IN LIEU OF ANY OTHER WARRANTIES OR REMEDIES, EXPRESS, IMPLIED OR STATUTORY.

Governing Law: This Limited Warranty shall be governed by the laws of the State of California. Some states do not allow exclusion or limitation of incidental or consequential damages, or limitations on how long an implied warranty lasts, so the foregoing limitations and exclusions may not apply. This limited warranty provides specific legal rights and the product owner may also have other rights which vary from state to state.

Trademarks: D-Link is a registered trademark of D-Link Systems, Inc. Other trademarks or registered trademarks are the property of their respective manufacturers or owners.

Copyright Statement: No part of this publication or documentation accompanying this Product may be reproduced in any form or by any means or used to make any derivative such as translation, transformation, or adaptation without permission from D-Link Corporation/D-Link Systems, Inc., as stipulated by the United States Copyright Act of 1976. Contents are subject to change without prior notice. Copyright

©

2002 by D-Link Corporation/ D-Link Systems, Inc. All rights reserved.

CE Mark Warning: This is a Class B product. In a domestic environment, this product may cause radio interference, in which case the user may be required to take adequate measures.

FCC Statement: This equipment has been tested and found to comply with the limits for a Class B digital device, pursuant to part 15 of the FCC Rules. These limits are designed to provide reasonable protection against harmful interference in a residential installation. This equipment generates, uses, and can radiate radiofrequency energy and, if not installed and used in accordance with the instructions, may cause harmful interference to radio communication. However, there is no guarantee that interference will not occur in a particular installation. If this equipment does cause harmful interference to radio or television

Warranty and Registration

reception, which can be determined by turning the equipment off and on, the user is encouraged to try to correct the interference by one or more of the following measures:

- Reorient or relocate the receiving antenna.
- Increase the separation between the equipment and receiver.
- Connect the equipment into an outlet on a circuit different from that to which the receiver is connected.
- Consult the dealer or an experienced radio/TV technician for help.

Canada-Industry Canada (IC): To prevent radio interference to the licensed service, this device is intended to be operated indoors and away from windows to provide maximum shielding. Equipment (or its transmit antenna) that is installed outdoors is subject to licensing.

The wireless radio of this device complies with RSS 139 & RSS 210 Industry Canada. This Class B digital apparatus complies with Canadian ICES-003.

Operation is subject to the following two conditions:

- 1) this device may not cause interference and
- 2) this device must accept any interference, including interference that may cause undesired operation of the device.

Cet appareil numérique de la classe B conforme à la norme NMB-003 du Canada.

FCC Caution: Any changes or modifications not expressly approved by the party responsible for compliance could void the user's authority to operate this equipment.

For operation within 5.15 ~ 5.25GHz frequency range, it is restricted to indoor environment, and the antenna of this device must be integral.

Warranty and Registration

Important Note:

FCC Radiation Exposure Statement: This equipment complies with FCC radiation exposure limits set forth for an uncontrolled environment. This equipment should be installed and operated with minimum distance 20cm between the radiator & your body.

This transmitter must not be co-located or operating in conjunction with any other antenna or transmitter.

184

compliance could void the user's authority to operate this equipment.

This device complies with Part 15 of the FCC Rules. Operation is subject to the following two conditions:

(1) This device may not cause harmful interference, and (2) this device must accept any interference received, including interference that may cause undesired operation.

IMPORTANT NOTE:

FCC Radiation Exposure Statement:

This equipment complies with FCC radiation exposure limits set forth for an uncontrolled environment.

This equipment should be installed and operated with a minimum distance of about 8 inches (20 cm) between the radiator and your body.

This transmitter must not be co-located or operated in conjunction with any other antenna or transmitter.

Appendix: DPR-1040 Printer Compatibility List

MFP Supported on Windows XP

Printer Brand	Printer Model name	Type
Brother	Brother MFC 640CW	MFP
Brother	Brother MFC-5840CN	MFP
Canon	Canon 865R	DeskJet
Canon	Canon 960i	DeskJet
Canon	Canon LBP3200	Laser
Canon	Canon MP130 (MFP)	MFP
Canon	Canon MP370 (MFP)	MFP
Canon	Canon MP450 (MFP)	MFP
Canon	Canon MP500 (MFP)	MFP
Canon	Canon MP600 (MFP)	MFP
Canon	Canon MP760 (MFP)	MFP
Canon	Canon MP780 (MFP)	MFP
Canon	Canon MP830 (MFP)	MFP
Canon	Canon MP950 (MFP)	MFP
Canon	Canon S400	DeskJet
Canon	Canon FJ890	DeskJet
Canon	Canon IP 1000	DeskJet
Canon	Canon IP 8500	DeskJet
Dell	Dell A940	MFP
EPSON	EPSON 480SXU	DeskJet

Appendix: DPR-1040 Printer Compatibility List

EPSON	EPSON C45	DeskJet
EPSON	EPSON C63	DeskJet
EPSON	EPSON AcuLaser C1100	Laser
EPSON	EPSON CX1500 (MFP)	MFP
EPSON	EPSON CX3810 (MFP)	MFP
EPSON	EPSON CX4100 (MFP)	MFP
EPSON	EPSON CX4800 (MFP)	MFP
EPSON	EPSON CX5100 (MFP)	MFP
EPSON	EPSON CX5900 (MFP)	MFP
EPSON	EPSON CX7800 (MFP)	MFP
EPSON	EPSON EBL-6200L	Laser
EPSON	EPSON LP-1300	Laser
EPSON	EPSON PM-800DC	DeskJet
EPSON	EPSON PM-940C	DeskJet
EPSON	EPSON RX-630	MFP
EPSON	EPSON Style Photo R800	DeskJet
HP	HP 960C	DeskJet
HP	HP Color LaserJet 1600	Laser
HP	HP Color LaserJet 2600n	Laser
HP	HP Color LaserJet 2605	Laser
HP	HP Color LaserJet CM 1015 MFP	Laser
HP	HP Deskjet 3745	DeskJet
HP	HP Deskjet 3845	DeskJet
HP	HP Deskjet 3930	DeskJet
HP	HP Deskjet 5160	DeskJet
HP	HP Deskjet 5740	DeskJet

Appendix: DPR-1040 Printer Compatibility List

HP	HP Deskjet 6540	DeskJet
HP	HP Deskjet 6840	DeskJet
HP	HP Deskjet D1330	DeskJet
HP	HP Deskjet D2360	DeskJet
HP	HP Deskjet F380	DeskJet
HP	HP LaserJet 1012 (GDI)	Laser
HP	HP LaserJet 1020 (GDI)	Laser
HP	HP LaserJet 1022 (GDI)	Laser
HP	HP LaserJet 1160	Laser
HP	HP LaserJet 2200D	Laser
HP	HP LaserJet 3015	Laser
HP	HP LaserJet 3050	Laser
HP	HP Officejet 4110 (MFP)	MFP
HP	HP Officejet 4255	MFP
HP	HP Officejet 5510 (MFP)	MFP
HP	HP Officejet 5610 (MFP)	MFP
HP	HP Officejet 6110 (MFP)	MFP
HP	HP Officejet 6210 (MFP)	MFP
HP	HP Officejet 6310 (MFP)	MFP
HP	HP Officejet 7210(MFP)	MFP
HP	HP Officejet 7310 (MFP)	MFP
HP	HP Officejet 7410 (MFP)	MFP
HP	HP Officejet C6180 (MFP)	MFP
HP	HP Officejet Pro K850 (MFP)	DeskJet
HP	HP Photosmart 1215	DeskJet
HP	HP Photosmart 2610	MFP

Appendix: DPR-1040 Printer Compatibility List

HP	HP Photosmart 2710	MFP
HP	HP Photosmart 3210	MFP
HP	HP Photosmart 3310	MFP
HP	HP Photosmart 335	DeskJet
HP	HP Photosmart 375	DeskJet
HP	HP Photosmart 385	DeskJet
HP	HP Photosmart 422	DeskJet
HP	HP Photosmart 425	DeskJet
HP	HP Photosmart 428	DeskJet
HP	HP Photosmart 475	DeskJet
HP	HP Photosmart 7260	DeskJet
HP	HP Photosmart 7550	DeskJet
HP	HP Photosmart 7850	DeskJet
HP	HP Photosmart 7960	DeskJet
HP	HP Photosmart 8050	DeskJet
HP	HP Photosmart 8250	DeskJet
HP	HP Photosmart 8450	DeskJet
HP	HP Photosmart 8750	DeskJet
HP	HP Photosmart C4385	MFP
HP	HP Photosmart C5280	DeskJet
HP	HP Photosmart C6180	DeskJet
HP	HP Photosmart D5160	DeskJet
HP	HP Photosmart D5180	DeskJet
HP	HP Photosmart D7160	DeskJet
HP	HP Photosmart D7360	DeskJet
HP	HP PSC 1210 (MFP)	MFP

Appendix: DPR-1040 Printer Compatibility List

HP	HP PSC 1315 (MFP)	MFP
HP	HP PSC 1350 (MFP)	MFP
HP	HP PSC 1410 (MFP)	MFP
HP	HP PSC 1507 (MFP)	MFP
HP	HP PSC 1510 (MFP)	MFP
HP	HP PSC 1600 (MFP)	MFP
HP	HP PSC 1610(MFP)	MFP
HP	HP PSC 2210 (MFP)	MFP
HP	HP PSC 2355 (MFP)	MFP
HP	HP PSC 750 (MFP)	MFP
Kyocera	Kyocera FS-3820N	Laser
LEXMARK	LEXMARK E232	Laser
LEXMARK	LEXMARK X4550 (MFP)	MFP
LEXMARK	LEXMARK X6200 (MFP)	MFP
LEXMARK	LEXMARK X7170 (MFP)	MFP
LEXMARK	LEXMARK X8350 (MFP)	MFP
LEXMARK	LEXMARK Z33	DeskJet
LEXMARK	LEXMARK Z53	DeskJet
LEXMARK	LEXMARK Z818	MFP
LEXMARK	LEXMARK X4270 (MFP)	MFP
LEXMARK	LEXMARK X5150 (MFP)	MFP
LEXMARK	LEXMARK X2350 (MFP)	MFP
LEXMARK	LEXMARK X3350 (MFP)	MFP
OKI	OKI-C5400n	Laser
Samsung	Samsung M-1710	Laser
Samsung	Samsung SCX-4200	MFP

MFP Supported on Windows Vista

Other Printers from the brands listed above may also be supported.

For an updated compatibility list please visit: <http://support.dlink.com.tw>

Printer Brand	Printer Model name	Type
Canon	Canon LBP3200	Laser
Canon	Canon MP950 (MFP)	MFP
HP	HP Color LaserJet 1500L	Laser
HP	HP Color LaserJet 1600	Laser
HP	HP Color LaserJet 2600n	Laser
HP	HP Color LaserJet 2605	Laser
HP	HP Color LaserJet CM 1015 MFP	Laser
HP	HP Deskjet 3845	DeskJet
HP	HP Deskjet 5740	DeskJet
HP	HP Deskjet D4160	DeskJet
HP	HP Deskjet F380	DeskJet
HP	HP LaserJet 1160	Laser
HP	HP LaserJet M1005 MFP	Laser
HP	HP Officejet 4110 (MFP)	MFP
HP	HP Officejet 6210 (MFP)	MFP
HP	HP Officejet 7410 (MFP)	MFP
HP	HP Photosmart 2710	MFP
HP	HP Photosmart 422	DeskJet
HP	HP Photosmart 475	DeskJet
HP	HP Photosmart A516	DeskJet

Appendix: DPR-1040 Printer Compatibility List

HP	HP Photosmart A616	DeskJet
HP	HP Photosmart 8050	DeskJet
HP	HP Photosmart 8250	DeskJet
HP	HP Photosmart C4480	DeskJet
HP	HP Photosmart C5180 (MFP)	DeskJet
HP	HP Photosmart C5280	DeskJet
HP	HP Photosmart C7280	DeskJet
HP	HP Photosmart D7160	DeskJet
HP	HP PSC 1600 (MFP)	MFP
HP	HP PSC 1610(MFP)	MFP
HP	HP PSC 2355 (MFP)	MFP